

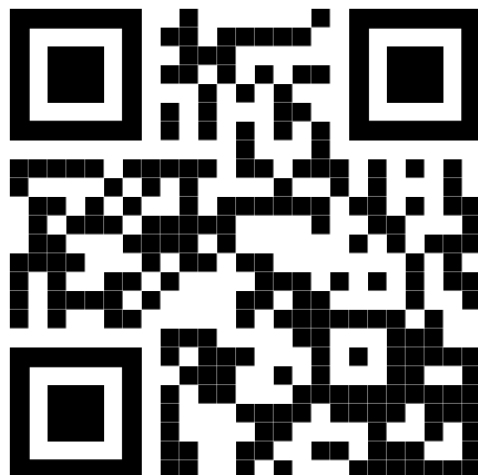

WIZARD V2 CROSSBAR FOR FLUSH RAILS



PLEASE WATCH THE INSTALLATION VIDEO TO HAVE
A BETTER UNDERSTANDING.





ATTENTION

- Don't cut the bars or scrape the plastic headers! These crossbars are vehicle specific and bar lengths vary by model.
- If one bar is longer than the other, the front of your vehicle is wider than the back.
- In this case, install the longer bar on the front and the shorter bar on the rear.
- If you can't fit it, there may be a point you missed.
- If you cut the bars and don't insert cross bars fully into the mount, the bars carrying capacity will decrease. In this case, Erkul Auto will not accept responsibility.
- If you need assistance please do not hesitate to contact us via your shopping channel.

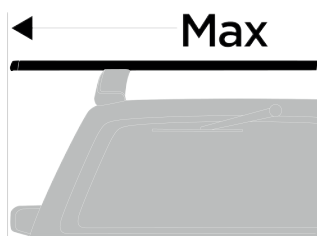
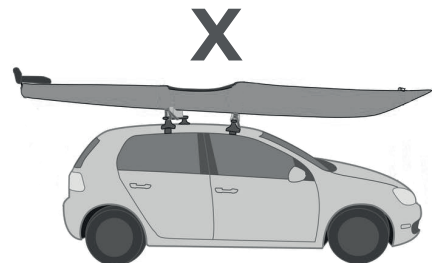
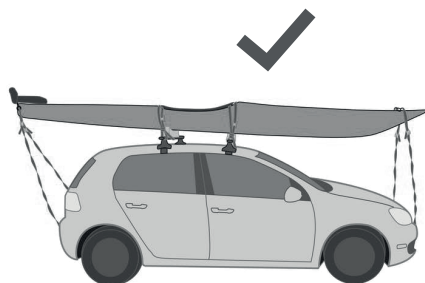

X



PACKAGE INCLUDED



- 1 set of crossbars
- 1 set of rubber pieces
 - Plastic keys
 - Allen key

Watch our installation video using the QR Code below.



ASSEMBLY INSTRUCTION

PLEASE WATCH THE INSTALLATION VIDEO TO HAVE
A BETTER UNDERSTANDING.

1)



First, measure the area
between your roof rails on
rear side.
(You should measure it
from inside to inside)

2)

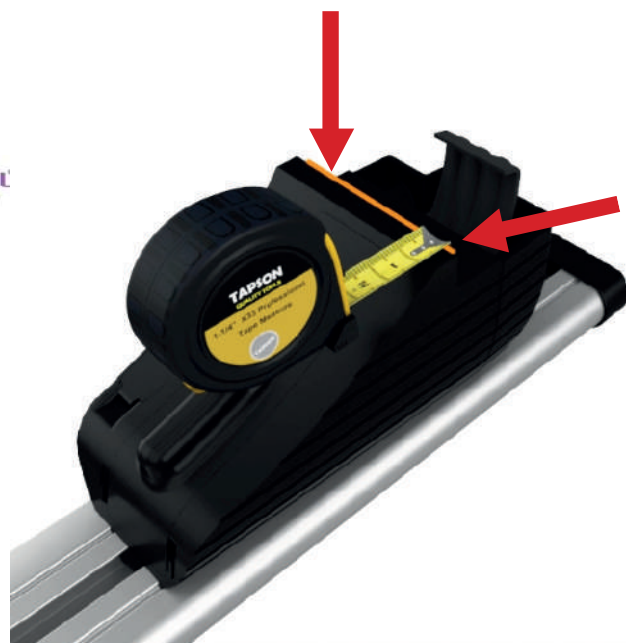

Center and adjust your crossbar
according to your roof length
(pay attention to the start and
end point for measurement)

**PLEASE WATCH THE INSTALLATION VIDEO TO HAVE
A BETTER UNDERSTANDING.**

3)

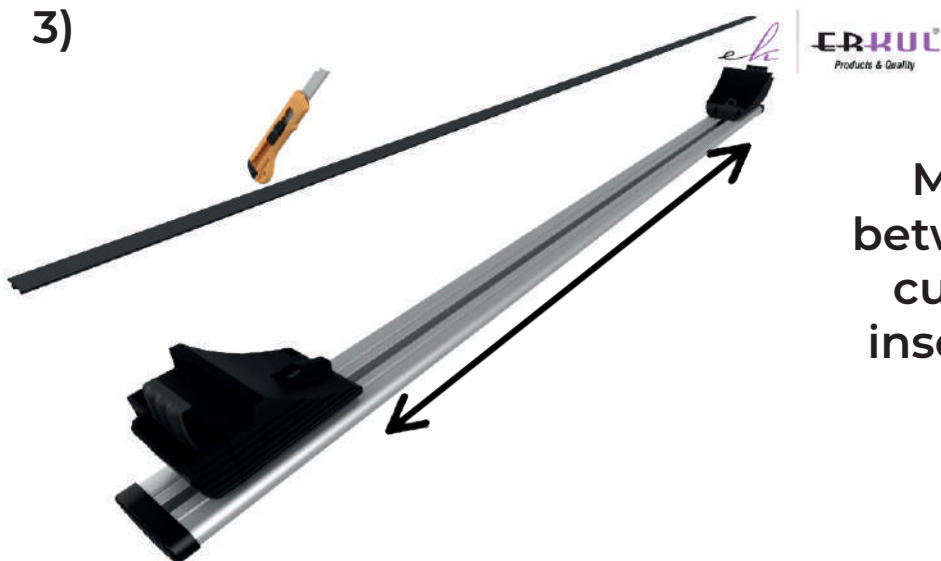

**Measure the area
between the brackets,
cut the rubber and
insert into the alumi-
num bar.**

**If you make a mistake at the length of the rubber, you
can make it right by adding small pieces.
REPEAT STEPS 1-3 FOR FRONT SIDE, TOO.**

4)



**Clean and dry
vehicle's roof.**

**PLEASE WATCH THE INSTALLATION VIDEO TO HAVE
A BETTER UNDERSTANDING.**

5)



**Place the crossbars on
the roof.**

6)



**Tighten the
screw until snug,
approximately
%50.**

**PLEASE WATCH THE INSTALLATION VIDEO TO HAVE
A BETTER UNDERSTANDING.**

7)



**Tighten the
other side of the
same bar until
%50, too.**

8)



**Go back to the first
side and tighten it
fully. Then, move to
the other side one
more time and fully
tighten that one, too.**

**PLEASE WATCH THE INSTALLATION VIDEO TO HAVE
A BETTER UNDERSTANDING.**

9)



**Put the covers of
both sides and lock
them.**

10)

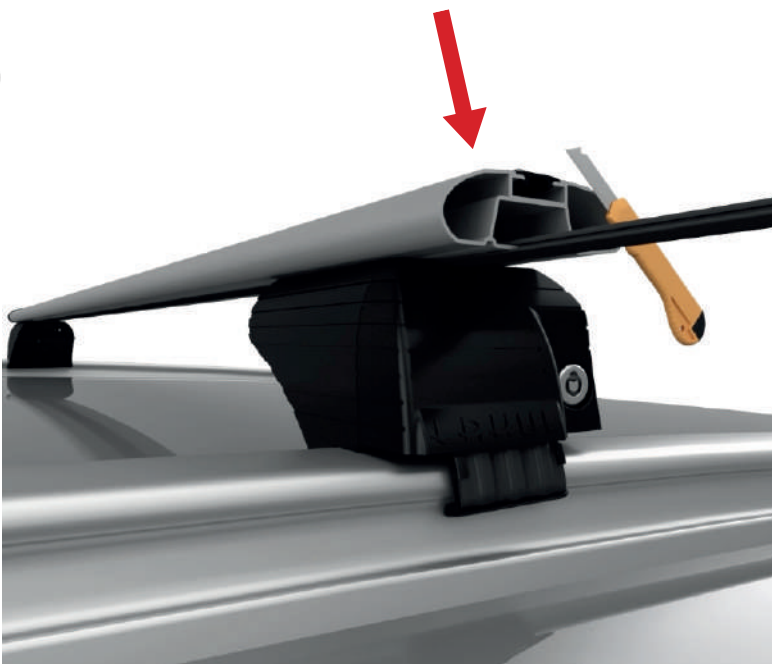

**Remove the upper cover,
insert the rubber to the
below, cut the extra.
Place the cover again.
Repeat the same for the
other side.**

**PLEASE WATCH THE INSTALLATION VIDEO TO HAVE
A BETTER UNDERSTANDING.**

- 11) Repeat the steps 1-10 for the other bar, too.



To check the fitment, firmly grasp load bars and attempt to move forward and backwards, side to side.

TO USE T-BOLTS:

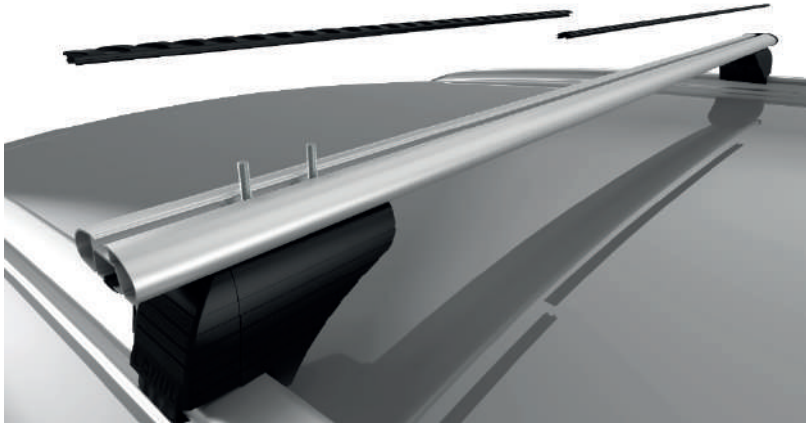

Take the rubbers off and insert T-Bolts. Insert the rubbers again after you remove T-Bolts.

You can also cut small pieces on rubber for T-Bolts and use with rubbers.



Note: T-tracks are not included the package.

SAFETY PRECAUTIONS!

1. Confirm that you have all required parts by checking the assembly instructions.
2. Regularly check for worn-out or damaged parts and replace them.
3. Regularly clean and maintain the load bars, especially during the winter.
4. Store all loose parts in a safe place when the product is removed.
5. Review and follow the assembly instructions and the suggestion list. Complete each step in the order recommended.
6. With the load bars installed, some sunroofs and/or radio antennas may not be operable, or some of their functions may be limited.
7. Except where otherwise stated in the mounting instructions, the load bars can be installed on cars with sunroofs.
8. Keep a minimum gap of 27 inches (700 mm) between the load bars.
9. Keep a minimum distance of 23 inches (600mm) between the load bars while carrying heavy loads.
10. Ensure that the load bars are securely mounted on the roof each time they are installed. To check the security of the bars, firmly grasp them and attempt to move them forward and backwards, as well as side to side. If any part of the unit moves, the mounting screws must be tightened to prevent movement. Check the security of the load bars on a regular basis.
11. Do not exceed the maximum load limit of 165lbs (75kg). This limit may be less depending on the maximum roof load recommended by the vehicle manufacturer. Always defer to the lowest maximum suggested roof load.
12. The maximum roof load is equal to the weight of the load bars plus any installed carrier accessories plus the weight of the load itself.
13. Any items carried on the load bars MUST be securely fastened. The use of elastic bungees is not safe.

SAFETY PRECAUTIONS!

14. Surfboards and other long items must be fastened at both the front and back of the vehicle when being transported.
15. When transporting multiple surfboards, stack them one on top of the other rather than next to each other.
16. The load must not be wider than the load bars width, and it must be equally distributed across the bars with the lowest possible center of gravity.
17. Prior to loading, all loose or removable pieces of the load, such as bicycle child seats, tire pumps, surfboard fins, etc. should be removed.
18. Ski's must be installed with the ski tips facing the rear of the vehicle when being transported.
19. Check the load's initial security after a short distance and at regular intervals on longer drives, at highway speeds, or on bumpy roads. When required, tighten the load's fastening straps.
20. When carrying taller items such as upright bicycles, the total height of the vehicle rises significantly. Use caution when clearance is low or when entering parking structures.
21. When a load is carried on the roof, the vehicle's handling and braking behavior can change, and it is more susceptible to cross-winds.
22. The vehicle's speed must always be adjusted to the load being transported as well as current driving conditions, such as road type, road quality, wind conditions, traffic intensity, and relevant speed limits, but speeds must never exceed 80MPH (130 km/h). Speed limits and other traffic restrictions must always be followed.
23. Drive slowly over speed bumps, with a top speed of 6 MPH (10 km/h).
24. While in use, lock any products which are equipped with locks.
25. This product may not be altered in any way.
26. The manufacturer will not be held liable for human or animal injury, property damage, or financial loss resulting from improper installation or use of the device. Always double-check that the load is properly secured



WIZARD V2 CROSSBAR FOR FLUSH RAILS



PLEASE WATCH THE INSTALLATION VIDEO TO HAVE
A BETTER UNDERSTANDING.

