





# EASY BLINDS

## ROLLER SHADES

### Installation Manual

PARTS INVENTORY		
ID	DESCRIPTION	QTY
(A)	CONTROL BRACKET 	1
(B)	IDLE END BRACKET 	1
(C)	CONTROL END 	1
(D)	IDLE END 	1
(E)	P CLIP 	1
(F)	SCREW	8

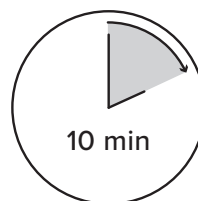

10 min

TIME

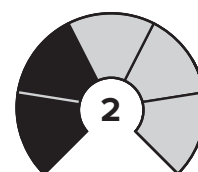

DIFFICULTY

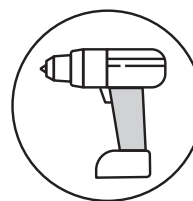

REQUIRED TOOL

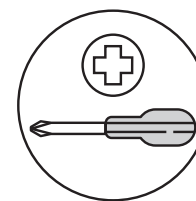

REQUIRED TOOL

⚠ Never free a roller shade with a knife or any object that may damage the fabric.

# BEFORE INSTALLATION

1

**!** The controls will be placed where you asked during the ordering process. If you want to change the side they're on, simply unplug the controls from the tube. This should be completed before the brackets are installed.

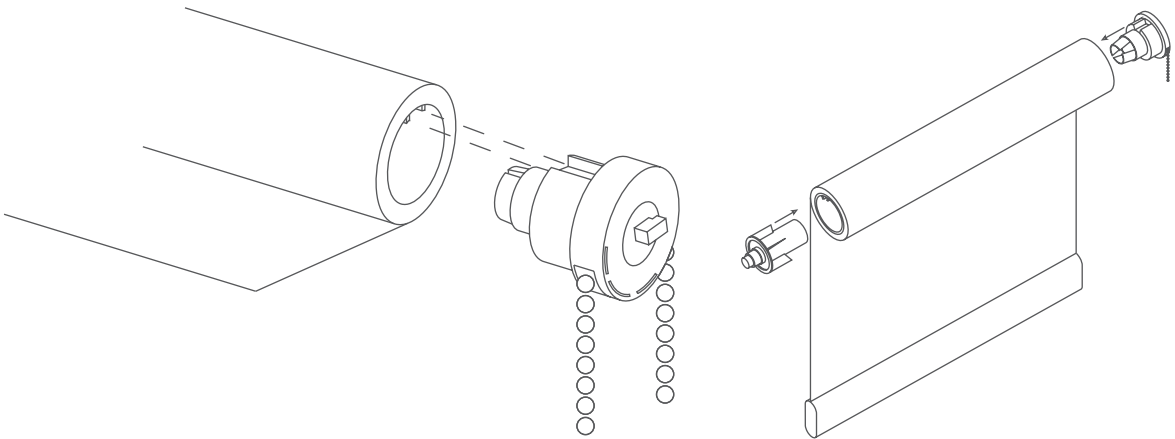
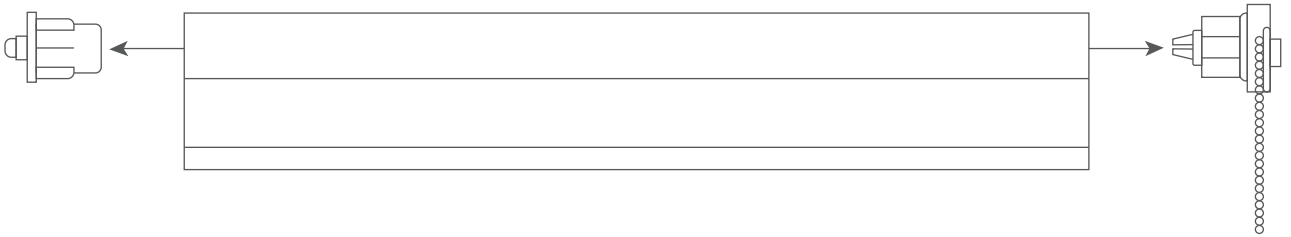

# BRACKET INSTALLATION

2

## INSIDE MOUNT

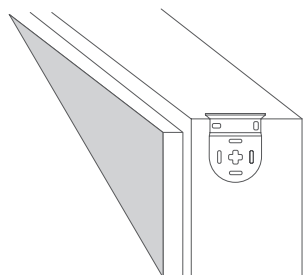

Inside mount the brackets within the window frame.

## OUTSIDE MOUNT

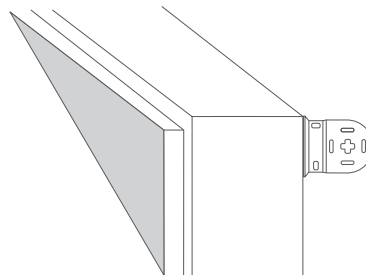

Mount the brackets on the surface of wall or window frame.

## Mount The Brackets

Position brackets so that the blinds can be raised and lowered freely. Be sure to position the brackets in such that the roller shade won't come into contact with any window, handles or any other obstacles.

Place the control bracket with chainside of blind, and idle end bracket with idle end of blind. Mark the position of both brackets. Drill holes and mount brackets into place (use wall anchors if needed). Be sure that brackets are aligned or the blind will not operate properly.



**Note:** On the side with the spring idle end, it should be slightly depressed (ideally halfway in) when installation is complete.

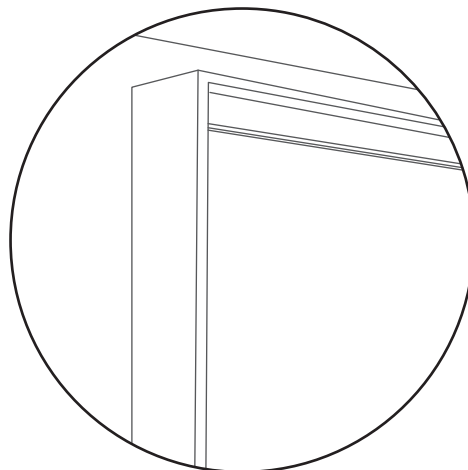
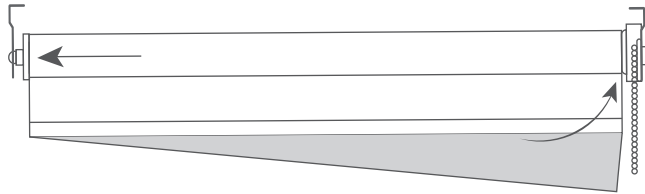

Image of mount attached to the wall.

# INSERT SHADE WITHIN BRACKET

**3**

## Mounting Your Blind

Place the spring idle end into the round hole of idle end bracket. While pushing the idle end towards the bracket, slide the control end into control bracket.

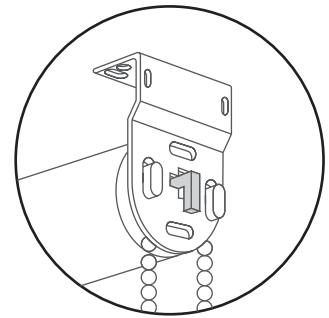

The control end center hook should point downwards and connect onto the bracket cross section.

# INSERT SHADE WITHIN BRACKET

## 4

### Chain Guard and Cord Tensioner

1. Check that the chain is tight and that the P-Clip is at the bottom of the loop, however the chain is operable.
2. Screw the cord tensioner to a wall near the blind to keep the chain tight. To use the shade, raise the chain guard to operate the shade.
3. Attached are stop balls on the chain, this prevents the blinds being raised or lowered past its limits.

To raise or lower your shade, pull the chain guard to expose the bottom of the chain. Use the exposed chain to raise or lower your shade accordingly. Release the chain guard to conceal the chain.

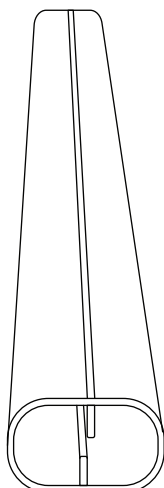
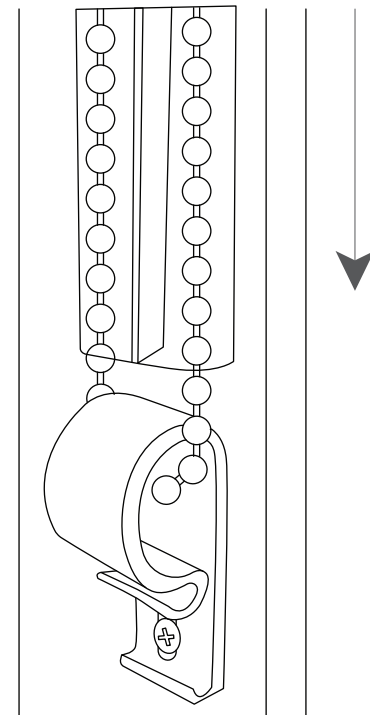
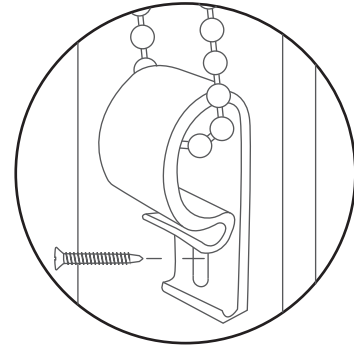

### **! WARNING**

1030640 Rev. 6/21 Print 9/21



**STRANGULATION HAZARD** – Young children can be strangled by cords. Immediately remove this product if a cord longer than 22 cm or a loop exceeding 44 cm around becomes accessible.

### **! MISE EN GARDE**

**RISQUE D'ÉTRANGLEMENT** – Les enfants en bas âge peuvent s'étrangler avec des cordes. Enlevez immédiatement ce produit si une corde mesurant plus de 22 cm devient accessible ou si le contour d'une boucle de plus de 44 cm devient accessible.