







# EASY BLINDS

## FAUX WOOD BLINDS

### Installation Manual

PARTS INVENTORY		
ID	DESCRIPTION	QTY
(A)	SCREW 	6
(B)	MOUNTING BRACKETS (1 PAIR) 	1
(C)	CENTRE BRACKET 	1
(D)	VALANCE CLIP 	1
(E)	VALANCE RETURN CLIP 	2
(F)	VALANCE 	1
(G)	HOLD DOWN BRACKETS WITH SCREWS (1 PAIR)	1

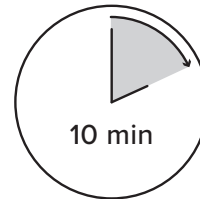

10 min

TIME

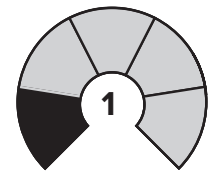

1

DIFFICULTY

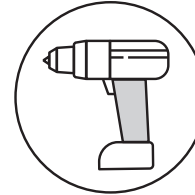

REQUIRED TOOL  
8MM / 5/16" DRILL BIT

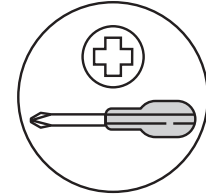

REQUIRED TOOL

! Valance Clip (D) Quantity varies based on blind width size tools: Saw and tape measure.

! Centre support only provided for blinds 50" or wider.

# BRACKET INSTALLATION



## OUTSIDE MOUNT

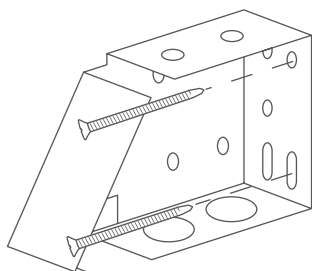

**FIG 1.1**  
Brackets are installed on surface of wall or window frame.

## TOP MOUNT

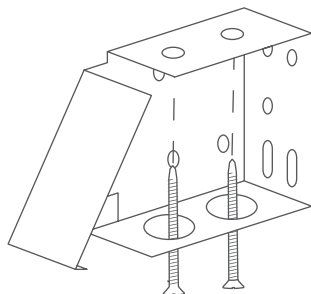

**FIG 1.2**  
Located top inside of the window frame (inside mount) or to the ceiling (outside mount).

## SIDE MOUNT

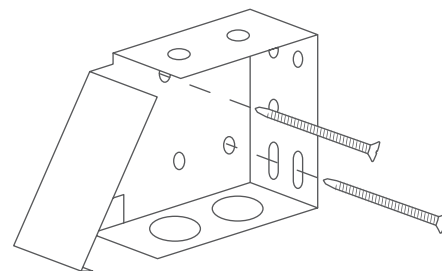

**FIG 1.3**  
Most common for mounting within the window frame (inside mount order).



**!** Before installing, align the top of the center support bracket with the top of the mounting bracket. Install the center support bracket with the larger flap on the top side, clear of the ladder cord/tape positions.

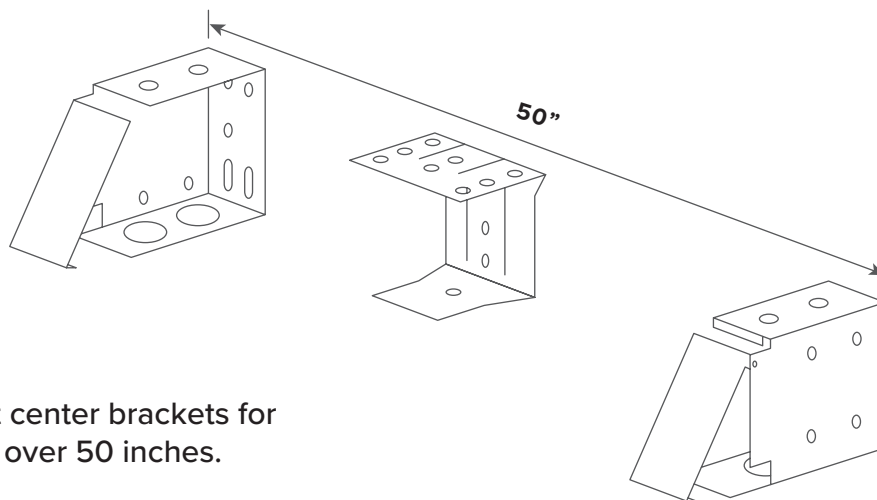

Mount center brackets for blinds over 50 inches.

# VALANCE INSTALLATION

## 2A

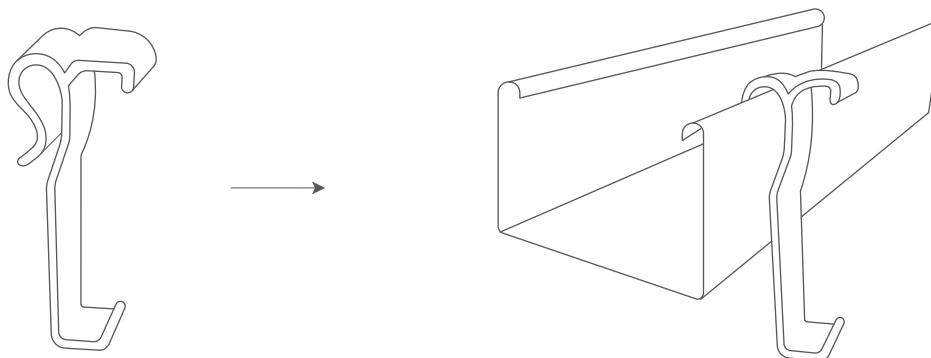

Attach the valance clips to the outside of headrail. Make sure they're all aligned.

## 2B

! You might need to shorten your valance. Measure the correct length and cut with a saw.

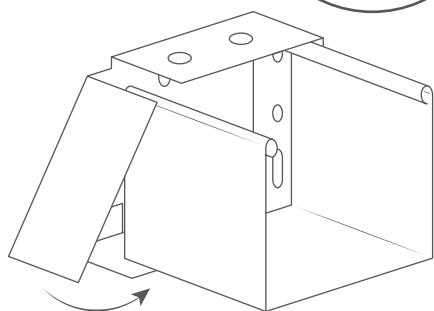
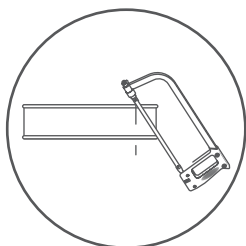

**FIG 2.**  
Lower the front gate of the mounting bracket and press until the locking tab clicks into place. (Fig 2.). To open use a screwdriver within slot below of front gate.

## 2C

### OUTSIDE MOUNT

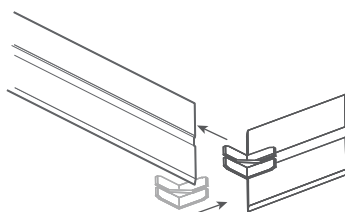

Push firmly one end of the valance return clip onto the valance. Slide the other end of the valance return clip onto the valance return once it is secure.

✓ You can now connect the valance to the headrail with the valance clips.

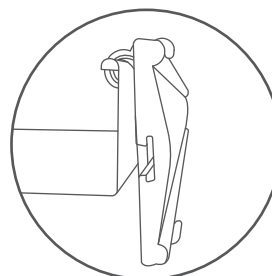

# HOLD DOWN BRACKETS

3

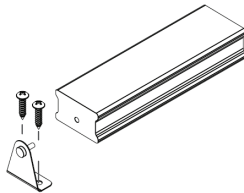

Lower the blind bottom rail down.

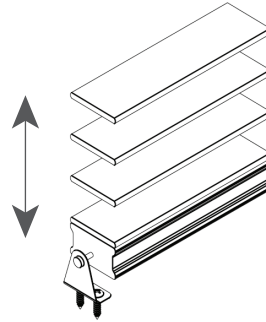

Mount the hold down brackets, so the tab is aligned with center holes in the end caps of bottom rail

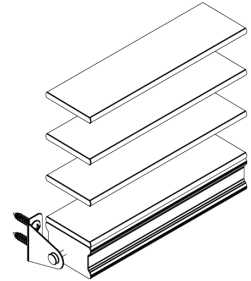

Insert the pin the thru hold down brackets into end caps of bottom rail.

## **!** WARNING

1030640 Rev. 6/21 Print 9/21



**STRANGULATION HAZARD** – Young children can be strangled by cords. Immediately remove this product if a cord longer than 22 cm or a loop exceeding 44 cm around becomes accessible.

## **!** MISE EN GARDE

**RISQUE D'ÉTRANGLEMENT** – Les enfants en bas âge peuvent s'étrangler avec des cordes. Enlevez immédiatement ce produit si une corde mesurant plus de 22 cm devient accessible ou si le contour d'une boucle de plus de 44 cm devient accessible.