

Range
—
FOREST



—
PRICELIST
PRESS

—
EXPORT
01.07.2022



Range

FOREST

FOREST is the series where you get the nature completely into your home - the interplay between steel and wood gives FOREST a solid, natural and quality expression. The series contains endless possibilities.

Designed by



This range include

Dining tables | Coffee tables
Sideboards | HIFI sideboards
Benches

Features



Design elements

Choose between different designs on plates, legs and edgeprofiles.



Custommade

In addition to our many standard sizes we can accommodate special requests.



Wood colours

Choose between more than 10+ different wood colours in both ash and oak.



Sustainable choice

Solid wood furniture can last a lifetime with proper maintenance

Social media

Follow and share with us on Instagram.



@kristensenfurniture | #kristensenfurniture

Online Pricelist- and imagebank

On our sharefile you as a retailer always have access to the newest pricelists and hundreds of high resolution images and videos
— **Free to use in your marketing!**

If you do not have an account yet, please contact us and then we will set it up for you!

INFO

Customize your new dining table

CHOOSE PLANK & THICKNESS

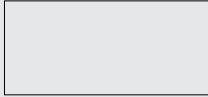

1 PLANK
3 cm or 4 cm



2 PLANK
3 cm or 4 cm

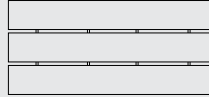

3 PLANK
3 cm or 4 cm

CHOOSE EDGE PROFILE



STRAIGHT



ANGLED
on the long sides



NATURAL CURVED*
on the long sides

CHOOSE SIZE

We offer a wide range of standard sizes, but for an extra fee it is also possible to get tables in special sizes.

All tables here are prepared for end leaves.

STANDARD SIZES

- 160 x 90 cm
- 180 x 90 cm
- 200 x 100 cm
- 220 x 100 cm
- 240 x 100 cm
- 260 x 100 cm
- 290 x 100 cm

CHOOSE LEGS



X
X-leg in steel
10x2 cm

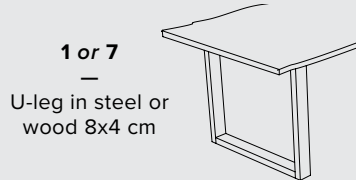

1 or 7
U-leg in steel or
wood 8x4 cm



HX
X-leg in steel
10x10 cm

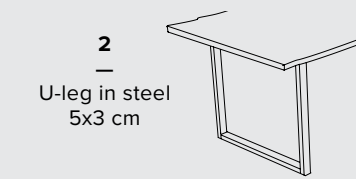

2
U-leg in steel
5x3 cm

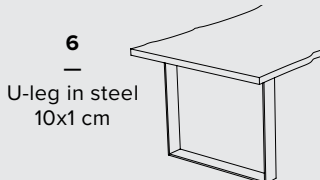

6
U-leg in steel
10x1 cm

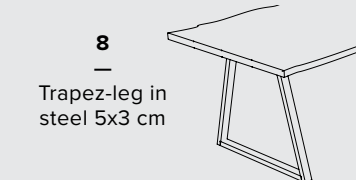

8
Trapez-leg in
steel 5x3 cm

See all leg positions at the back of this pricelist.

CHOOSE WOOD COLOUR

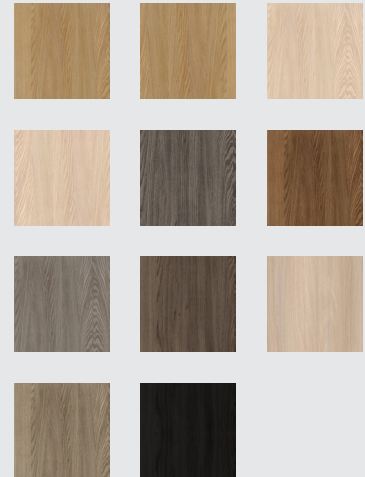

STEEL COLOUR OPTIONS**

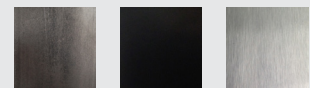

Read more about this at the back of this pricelist.

*This is the natural - debarked - edge of the wooden planks. Each edge is unique which means that the curvature can be more or less expressive from one table to another.

**Standard is industrial or black steel, but stainless steel can be offered on leg 1, 2 & 8.

PRICELIST

Dining tables with 30 mm plate thickness (prepared for leaves)

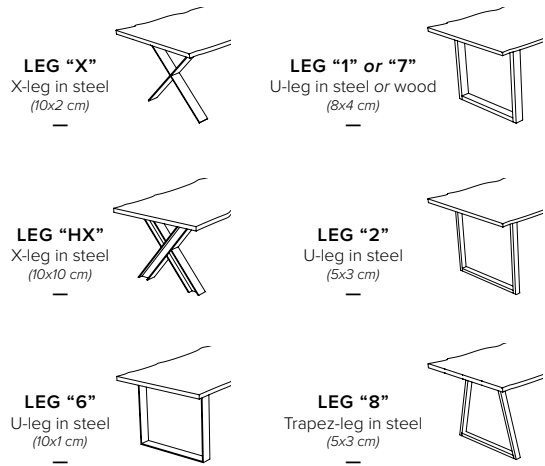

Variant	Size (cm)		Item no.			Price (EUR)	
	L	W	1-plank	2-plank	3-plank	ASH	OAK
30 mm plate thickness (table height 74 cm)							
With leg variant:	160	90	00207	20207	00107		
steel leg X	180	90	00209	20209	00109		
steel leg HX	200	100	00210	20210	00110		
steel leg 6	220	100	00211	20211	00111		
	240	100	00213	20213	00113		
	260	100	00215	20215	00115		
	290	100	00217	20217	00117		
With leg variant:	160	90	00207	20207	00107		
steel leg 1*	180	90	00209	20209	00109		
steel leg 2*	200	100	00210	20210	00110		
steel leg 8*	220	100	00211	20211	00111		
wooden leg 7	240	100	00213	20213	00113		
	260	100	00215	20215	00115		
	290	100	00217	20217	00117		

Leaf	L	W	Item no.	Price (EUR)
for tables 30 mm	50	90	00200	00100
	50	100	00201	00101

*Standard steel is industrial (A) or black (B), but these legs can be made in stainless steel (C) +10%.

PRICELIST

Dining tables with 40 mm plate thickness (prepared for leaves)

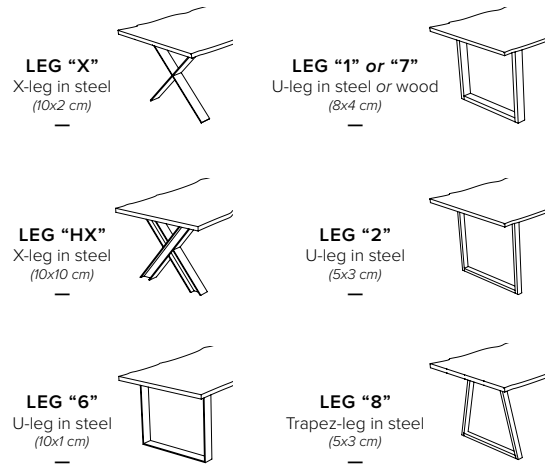

Variant	Size (cm)		Item no.			Price (EUR)	
	L	W	1-plank	2-plank	3-plank	ASH	OAK
40 mm plate thickness (table height 75 cm)							
With leg variant:	160	90	00227	20227	00127		
steel leg X	180	90	00229	20229	00129		
steel leg HX	200	100	00230	20230	00130		
steel leg 6	220	100	00231	20231	00131		
	240	100	00233	20233	00133		
	260	100	00235	20235	00135		
	290	100	00237	20237	00137		
With leg variant:	160	90	00227	20227	00127		
steel leg 1*	180	90	00229	20229	00129		
steel leg 2*	200	100	00230	20230	00130		
steel leg 8*	220	100	00231	20231	00131		
wooden leg 7	240	100	00233	20233	00133		
	260	100	00235	20235	00135		
	290	100	00237	20237	00137		

Leaf	L	W	Item no.	Price (EUR)
for tables 40 mm	50	90	00220	20220
	50	100	00221	20221

*Standard steel is industrial (A) or black (B), but these legs can be made in stainless steel (C) +10%.

PRICELIST

Benches with 30 or 40 mm plate thickness

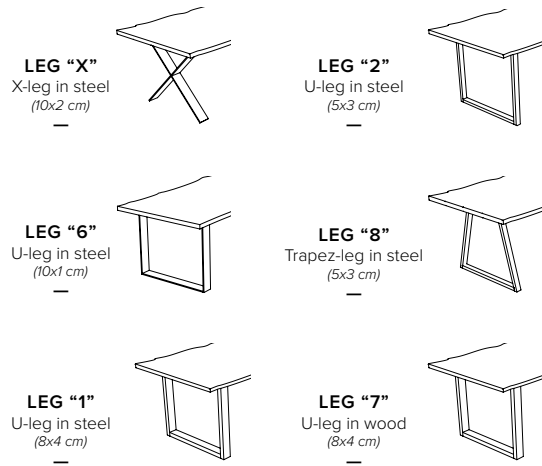

Variant	Size (cm)		Item no.		Price (EUR)	
	L	W	30** mm plate	40** mm plate	ASH	OAK
With leg variant: steel leg X	160	40	00620	00630		
	180	40	00621	00631		
	200	40	00622	00632		
	220	40	00623	00633		
	240	40		00634		
With leg variant: steel leg 6	160	40	00620	00630		
	180	40	00621	00631		
	200	40	00622	00632		
	220	40	00623	00633		
	240	40		00634		
With leg variant: steel leg 1* steel leg 2* steel leg 8* wooden leg 7	160	40	00620	00630		
	180	40	00621	00631		
	200	40	00622	00632		
	220	40	00623	00633		
	240	40		00634		

*Standard steel is industrial (A) or black (B), but these legs can be made in stainless steel (C) +10%.

**When 30 mm plate, total height is: 44 cm. When 40 mm plate, total height is: 45 cm.



1 PLANK

3 cm or 4 cm

PRICELIST

Coffee tables with 30 or 40 mm plate thickness

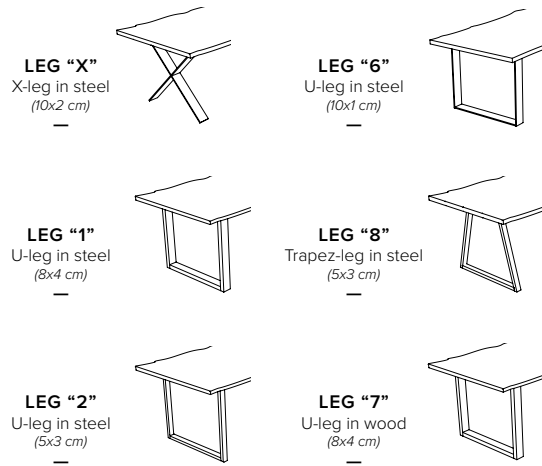

Variant	Size (cm)		Item no.		Price (EUR)	
	L	W	1-plank	2-plank	ASH	OAK
30 mm plate thickness (height 45 cm)						
With steel leg:	60	60	00255	20255		
X, 1*, 2*, 6, 8*	90	90	00256	20256		
or with	115	65	00257	20257		
wooden leg:	130	70	00258	20258		
	140	80	00259	20259		
40 mm plate thickness (height 46 cm)						
With steel leg:	60	60	00265	20265		
X, 1*, 2*, 6, 8*	90	90	00266	20266		
or with	115	65	00267	20267		
wooden leg:	130	70	00268	20268		
	140	80	00269	20269		

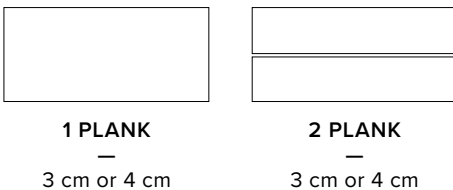

*Standard steel is industrial (A) or black (B), but these legs can be made in stainless steel (C) +10%.



PRICELIST

Sideboards

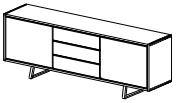
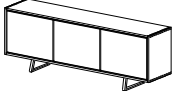

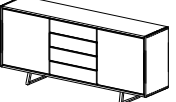
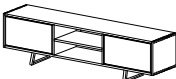
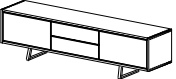
Sideboard variant	item no.	Size (cm)			Price (EUR)	
		W	D	H	ASH	OAK
<i>With steel leg: 8* or 2* or with wooden leg: 7</i>						
 w/2 doors & 3 drawers	6942	200	45	70		
 w/3 doors	6943	200	45	70		
 w/1 door & 4 drawers	6930	135	45	87		
 w/2 doors & 4 drawers	6932	200	45	87		
 HIFI** w/2 doors & 1 open room	6981	200	45	53		
 HIFI** w/4 doors (2 flip-down)	6982	200	45	53		

*Standard steel is industrial (A) or black (B), but these legs can be made in stainless steel (C) +10%.

**The HIFI sideboards are with holes for wires in the back.

INFO

Distance between legs on the dining tables

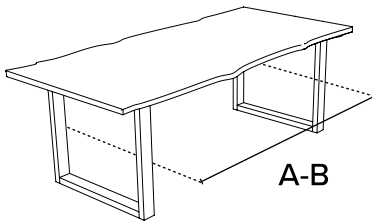

Leg variant	Table length	A-B measure*
 Leg X & HX	160	94
	180	114
	200	134
	220	154
	240	174
	260	194
	290	224
 Leg 1 & 7	160	98
	180	118
	200	138
	220	158
	240	178
	260	198
	290	228
 Leg 2 & 8	160	104
	180	124
	200	144
	220	164
	240	184
	260	204
	290	234
 Leg 6	160	115
	180	135
	200	155
	220	175
	240	195
	260	215
	290	245

*The distance between the legs. This gives you an idea of how many chairs to fit in.



Images for guiding purpose only!

The wood structure and colour will vary from ash and oak.

We therefore recommend using the wood samples/exhibition furniture to get a more accurate impression.

WOOD COLOURS



ASH C3 / OAK C3
Lacquered

We treated this wood with lacque.

C3 are only made for products without patination.



ASH C4 / OAK C4
Natural oiled

We treated this wood with our 'Natural oil'.



ASH C6 / OAK C6
White oiled

We treated this wood with our 'White oil'.



ASH C8 / OAK C8
Soaped

We treated this wood with soap.



ASH C11 / OAK C11
Dark grey oiled

We treated this wood with our 'Black oil'.



ASH C12 / OAK C12
Antique brown oiled

We treated this wood with our 'Antique brown oil'.



ASH C13 / OAK C13
Light grey oiled

We treated this wood with our 'Light grey oil'.



ASH C14 / OAK C14
Black stained & oiled

We treated this wood with black stain, and treated it with a wax oil.

C14 is for legs and storage furniture only!



ASH C15 / OAK C15
Mocca brown oiled

We treated this wood with our 'Mocca brown oil'.



ASH C16
Warm white oiled

We treated this wood with our 'Warm white oil'.

C16 is only for ash



ASH C20 / OAK C20
Grey brown oiled

We treated this wood with our 'Grey brown oil'.



ASH C44 / OAK C44
Black matt lacquered

We treated this wood with black stain, and treated it with matt lacque.

C44 is only for plates and can only be made for products without patination.



For more information about maintenance, please visit our website:
WWW.KRISTENSEN.COM



We also offers our own repairoils for our products
- contact us if you need a pricelist.

WOOD FINISH



UP

Without patination

The wood is planned and sanded to achieve a smooth surface.

With few and smaller knots.

Storage furniture can only be made with this finish!



SC

Soft Cracks

Naturally occurring cracks are made more visible which gives a rustic look with cracks in the surface.

May contain more and larger knots.

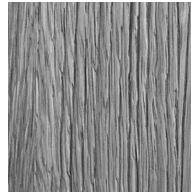

RL

Raw Look

We brush off the layer of softer wood which gives a look of wood that has been roughened by natural wear.

May contain more and larger knots.

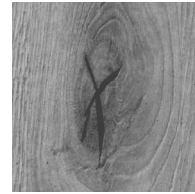

FK

Filled Knots

The knots are filled and the wood is planned and sanded to achieve a smooth surface.

Only for OAK!

STEEL COLOUR & FINISH

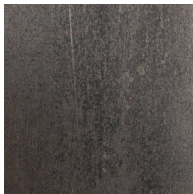

A

Industrial steel

Industrial steel has a raw and matte appearance with shades of colors emerged during casting.

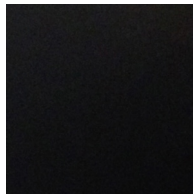

B

Black painted steel

Black painted steel has a graphical and simple look, that fits nicely in most homes.



C

Brushed stainless steel

Brushed, stainless steel has an elegant appearance with a uniform finish created by hand.

**Extra cost!
Not available on tables with leg X, HX and 6.**

SPACERS

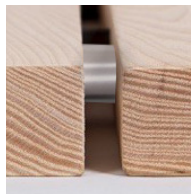
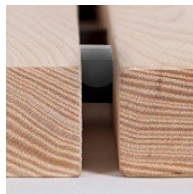
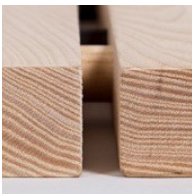

The spacers between the planks will be same material/finish as you choose the legs to be.

CONTACT

CUSTOMISED TABLES

We are able to produce all our table types in special sizes. Furniture in special sizes requires special handling both in terms of manual handling, new drawings, machine settings and packaging. We therefore include a surcharge for products in special sizes, whether the product will be larger or smaller. If you want a table in a smaller size e.g, the price is added 15% on the price of the nearest standard size.

Contact us for more information!

Agent, Norway

Paal Stenvaag

—

✉ post@mobelpaal.no

☎ +47 926 18 628

Agent, Finland

Jokko Salmevaara

—

✉ jokko.salmevaara@boknas.fi

☎ +358 401 958 886

Agent, Sweden

Mikael Deragården

—

✉ mikael@deragarden.com

☎ +46 0702 115 125

Agent, UK

Brendan Brett

—

✉ kristensen@theukagency.co.uk

☎ +44 77 34 265 599

Head office, Denmark

PHONE:

+45 75470303

WEBSITE:

www.kristensen.com

MAIL:

kristensen@kristensen.dk

ORDER MAIL:

order@kristensen.dk

CLAIMS:

claim@kristensen.dk

FAX:

+45 75470304

ADDRESS:

Kristensen & Kristensen A/S
 Storstrømsvej 44
 6715 Esbjerg N
 DK - Denmark

TERMS & CONDITIONS

—

Can be sent via email by request – contact:

kristensen@kristensen.com

