

2024

PRODUCT CATALOG

LEADING THE
SHEEP & GOAT INDUSTRY
FOR OVER 40 YEARS



Sydell®

SHEEP & GOAT EQUIPMENT

605.624.4538 | 800.842.1369
46935 SD HWY 50 | BURBANK, SD 57010-7019 USA

BEST SELLERS

From lambing and kidding pens, to show stands and complete working systems, Sydell has you covered. Here are our customer favorites!



LOOKING FOR SOMETHING?

Give us a call! We do custom work and are always adding new product lines.

BEST SELLERS

Our team has decades of experience raising sheep and goats. We can help you find the right products to suit your needs.



HAY & GRAIN FEEDERS | PAGE 22



ROLLER CREEP | PAGE 13



SPIN DOCTOR | PAGES 40-41



MINERAL FEEDERS | PAGE 21



LAPAROSCOPIC | PAGE 14



FENCELINE FEEDERS | PAGES 24-25



WORKING SYSTEMS | PAGES 27-39



HAY FEEDERS | PAGE 23



COMBO FEEDER | PAGE 20



LAMBING PENS | PAGES 6-13



SHOW/FAIR PENS | PAGES 15-17

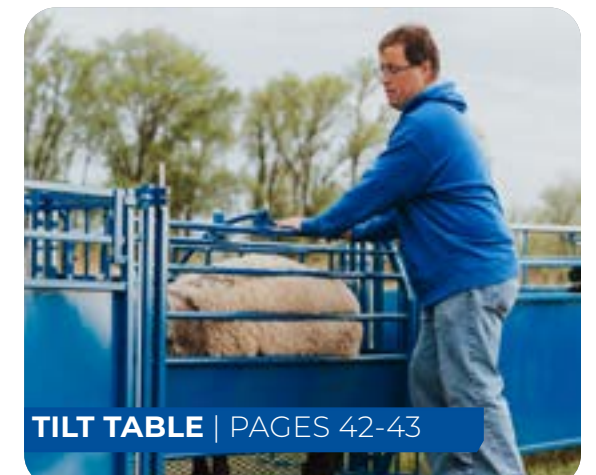

TILT TABLE | PAGES 42-43



FOLLOW US ON SOCIAL MEDIA TO FIND OUT WHAT'S HAPPENING IN 2024!  

Professional photo credit: Backroad Creative

New to the Industry?

We can help!

If you're just starting your operation, here are some go-to items you shouldn't be without. Our team is happy to answer any questions you may have as you build out your operation.



MINERAL FEEDER | PAGE 23



SPIN DOCTOR | PAGE 40-41



FOLDING PANEL | PAGE 12



HAY FEEDER | PAGE 22











FENCELINE FEEDER | PAGE 24

VIEW OUR ENTIRE OFFERING OF FEEDERS TO MEET ANY NEED ON PAGES 18-25!

2024 SHOW SCHEDULE

Order 30 days in advance for FREE delivery to shows! Space is limited!

DATE	SHOW/RUN	LOCATION
March 15-16	The Main Event Lamb & Goat Live Auction & Futurity Show	Des Moines, IA
March 28-30	Premier 10/Midwest Elite	Indianapolis, IN
March	<i>Tennessee Run (routing through Kansas City, St. Louis, Paducah, Nashville)</i>	
April 18-20	Oklahoma Black & White Show & Sale	Chickasha, OK
May 4-5	Maryland Sheep and Wool Festival	West Friendship, MD
May 13-14	<i>Western NY Run (routing near Cedar Rapids, Indianapolis, Cleveland/Akron/Columbus)</i>	
May 17-18	Young Guns Sale	San Angelo, TX
May 29-June 2	Nugget All American Show & Sale	Reno, NV
June 5-8	National Columbia Show and Sale	Spanish Fork, UT
June 7-14	ABGA National Show	Louisville, KY
June 10-15	Midwest Stud Ram Sale	Sedalia, MO
June 28-29	Southern States Dorper Sale and Show	Cookeville, TN
July 3 -7, 2023	All-American Junior Show	Lansing, MI
July 13-19	ADGA National Show	Louisville, KY
July 13-16	<i>Northeast/Massachusetts Run (watch Facebook to see our route)</i>	
July	<i>West Coast Run (watch Facebook to see our route)</i>	
August 1-3	Katahdin National Expo & Sale	Mexico, MO
August 16-17	Texas Sheep and Goat Expo	San Angelo, TX
Aug 29-Sept 2	South Dakota State Fair	Huron, SD
September 2	<i>Oregon/Northwest Run (routing I-90 South Dakota to Oregon; returning via I-84/I-80)</i>	
September 6-8	Wisconsin Sheep & Wool Festival	Jefferson, WI
September 19-20	Newell Ram Sale	Newell, SD
September 20-21	U of Florida Small Ruminant Course & Ram Sale Buck Test	Gainesville, FL
September 26-28	USA National Valais Blacknose Sheep	Des Moines, IA
November 7-21	North American International Livestock Expo	Louisville, KY

Table of Contents	 pg18 Feeders	 pg42 Tilt Table
 pg06 Lambing/Kidding	 pg27 Working Systems	 pg44 Stands
 pg15 Show/Fair Pens	 pg40 Spin Doctor	 pg55 About Us

LAMBING + KIDDING PENS

Easy carry lambing and kidding pens are durable and lightweight. With a variety of options available, Sydell pens are customizable to meet your needs.



OPTIONS AT A GLANCE

Whether you need freestanding or wall mount pens, or want add-ons to make work easier, we have the products and accessories you want.



LAMB SAFETY & WARMING ZONES



EWE HEADGATES



CREEP PEN



GRAFTING GATES



PAIL BRACKETS





WALK-THRU GATES



HANGING POLY HAY/GRAIN FEEDERS

VIEW OUR ENTIRE OFFERING OF LAMBING AND KIDDING PENS ON PAGES 8-13!

	DELUXE	STANDARD	FOLDING STYLE
OPTIONS	 <p>Wall Mount or Freestanding</p>	 <p>Wall Mount or Freestanding</p>	 <p>Wall Mount</p>
FINISH	Paint standard, Powder Coat and Galvanizing optional	Paint standard, Powder Coat and Galvanizing optional	Paint standard, Powder Coat and Galvanizing optional
SIZES	<p>6 different sizes:</p> <p>4' Wide x 5' Deep x 41.5"</p> <p>4' Wide x 6' Deep x 41.5"</p> <p>5' Wide x 5' Deep x 41.5"</p> <p>5' Wide x 6' Deep x 41.5"</p> <p>6' Wide x 5' Deep x 41.5"</p> <p>6' Wide x 6' Deep x 41.5"</p>	<p>2 different sizes:</p> <p>6' x 4' x 42"</p> <p>6' x 5' x 42"</p>	<p>1 size:</p> <p>5' x 5' x 40"</p>
FEATURES	<ul style="list-style-type: none"> • Safety Zone optional • Feed Front Panel option • Roller Creep available • Grafting Gate available • Easy Open Gate • Draft protection • Durable construction • Easily converts to show pen 	<ul style="list-style-type: none"> • Safety Zone standard • Feed Front Panel standard • Roller Creep available (4' width) • Grafting Gate available • Headlock available • Lightweight, durable construction • Pails/brackets included 	<ul style="list-style-type: none"> • Add Roller Creep for quick creep area • Durable, lightweight and versatile • Easy and versatile to set up and use anywhere on farm • Pail/brackets included
PRICE	Varies by size \$925-\$1,130	Varies by size \$685-\$825	\$270
PAGE	Details & Add-ons Pages 8-9	Details & Options Pages 10-11	Details & Options Page 12

DELUXE LAMBING/KIDDING PENS

These easy access pens also block cool drafts!

Sydell Deluxe Lambing/Kidding Pens offer multiple setup configurations including wall mount or freestanding, single row or back-to-back. Each pen includes an easy open handle on the gate, an arched frame front panel for additional support, and sheet metal on the bottom 18" for draft reduction. Begin with a starter pen and use add-on pens to make a customized connected row of pens.

- Easy open grip handle allows easy access into pen
- Durable construction
- Optional warming and safety zone
- Four different front panel options. (see next page)
- Available in six sizes
- Wall mount brackets included. (wall mount models)
- Galvanize or powder coat finish optional (longer process time)



Easy Open Front Gate

- 4' Panel 40" Opening
- 5' Panel 25 3/4" Opening
- 6' Panel 37 3/4" Opening



WALL MOUNT PENS

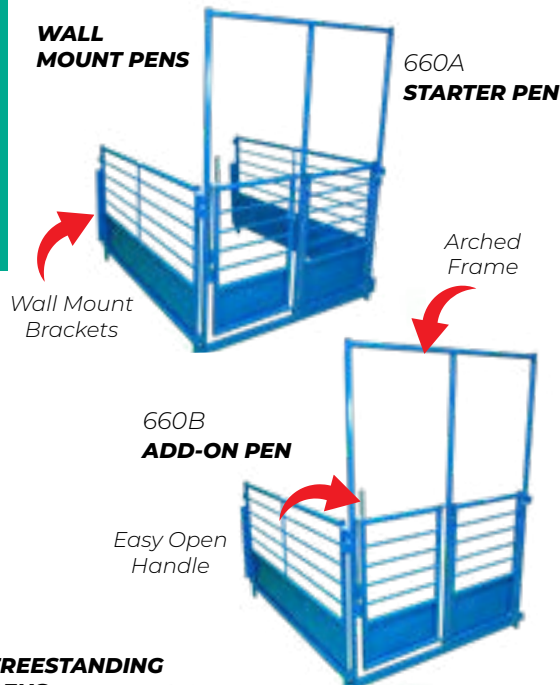

DELUXE WALL MOUNT PENS

ITEM	SIZE	PRICE
Starter Wall Mount Pen:		
Includes 1-653 -AHG, 1-653-1, 2-652 sides, 2-652 WMB, Drop Pins		
660A-45	4' Wide x 5' Deep x 41.5" Tall	\$925
660A-46	4' Wide x 6' Deep x 41.5" Tall	\$960
660A-55	5' Wide x 5' Deep x 41.5" Tall	\$925
660A-56	5' Wide x 6' Deep x 41.5" Tall	\$960
660A-65	6' Wide x 5' Deep x 41.5" Tall	\$960
660A-66	6' Wide x 6' Deep x 41.5" Tall	\$990

Add-On Wall Mount Pen

Includes 1-653 -AHG, 1-653-1, 1-652 side, 1-652 WMB, Drop Pins		
660B-45	4' Wide x 5' Deep x 41.5" Tall	\$695
660B-46	4' Wide x 6' Deep x 41.5" Tall	\$715
660B-55	5' Wide x 5' Deep x 41.5" Tall	\$695
660B-56	5' Wide x 6' Deep x 41.5" Tall	\$715
660B-65	6' Wide x 5' Deep x 41.5" Tall	\$730
660B-66	6' Wide x 6' Deep x 41.5" Tall	\$750

DELUXE FREESTANDING PENS

ITEM	SIZE	PRICE
Starter Free Standing Pen		
Includes 1-653 -AHG, 1-653-1, 2-652 sides, 1-652 back, Drop Pins		
665A-45	4' Wide x 5' Deep x 41.5" Tall	\$1,020
665A-46	4' Wide x 6' Deep x 41.5" Tall	\$1,060
665A-55	5' Wide x 5' Deep x 41.5" Tall	\$1,040
665A-56	5' Wide x 6' Deep x 41.5" Tall	\$1,080
665A-65	6' Wide x 5' Deep x 41.5" Tall	\$1,090
665A-66	6' Wide x 6' Deep x 41.5" Tall	\$1,130

Add-On Free Standing Pen

Includes 1-653 -AHG, 1-653-1, 1-652 side, 1-652 back, Drop Pins		
665B-45	4' Wide x 5' Deep x 41.5" Tall	\$840
665B-46	4' Wide x 6' Deep x 41.5" Tall	\$860
665B-55	5' Wide x 5' Deep x 41.5" Tall	\$860
665B-56	5' Wide x 6' Deep x 41.5" Tall	\$880
665B-65	6' Wide x 5' Deep x 41.5" Tall	\$910
665B-66	6' Wide x 6' Deep x 41.5" Tall	\$930

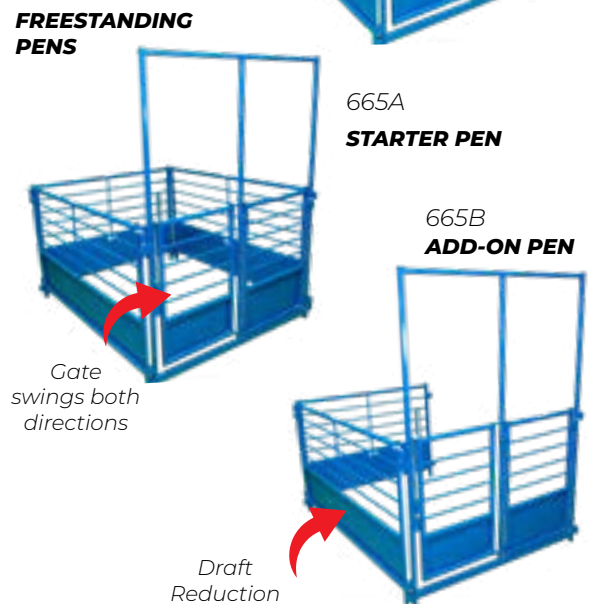

DELUXE FRONT PANELS WITH STANDARD PANEL



653-AHG4 653-AHG5 \$475 653-AHG6 \$495 \$470

DELUXE SIDE/BACK PANELS

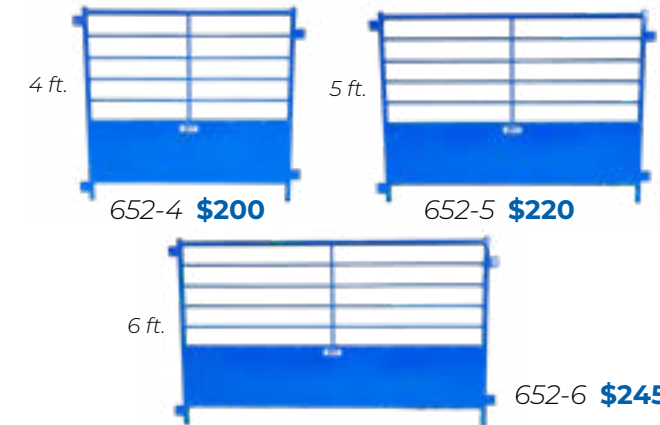

652-4 \$200 652-5 \$220 652-6 \$245

DELUXE ADD-ONS

for even more options!

DELUXE FRONT PANEL OPTIONS

Swap out the 653-1 with one of these useful options.



653-2 \$150 653-3 \$195 653-4 \$180

DELUXE PANELS (ALL INCLUDE 2 DROP PINS)

ITEM	DESCRIPTION	SIZE	PRICE
653-AHG4	Arched Gate w/40" Swing Gate Opening w/Standard Panel	4' Wide x 6'6" Tall	\$470
653-AHG5	Arched Gate w/25.75" Swing Gate Opening w/Standard Panel	5' Wide x 6'6" Tall	\$475
653-AHG6	Arched Gate w/37.75" Swing Gate Opening w/Standard Panel	6' Wide x 6'6" Tall	\$495
652-4	4' Lambing/Kidding Panel	4' Wide x 41.5" Tall	\$200
652-5	5' Lambing/Kidding Panel	5' Wide x 41.5" Tall	\$220
652-6	6' Lambing/Kidding Panel	6' Wide x 41.5" Tall	\$245
653-1	Pin in Standard Panel (pictured in 653-AHG6)	27" Wide x 38" Tall	\$140
653-2	Pin in Feed Front Panel	27" Wide x 38" Tall	\$150
653-3	Pin in Grafting Gate Panel	27" Wide x 43.5" Tall	\$195
653-4	Pin in Adjustable Vertical Roller Creep Gate Panel	27" Wide x 40" Tall	\$180

SAFETY ZONES

Easily attaches to pens where heat lamps will be used. One starter and one add-on per two pen setup.

ITEM	DESCRIPTION	PRICE
653-5A	Starter Safety Zone	\$205
653-5B	Add-On Safety Zone	\$165

WALL MOUNT BRACKET

Bracket only. Anchor bolts not included.

ITEM	DESCRIPTION	PRICE
652-WMB	Wall Mount Bracket for 652/653 Panels	\$31



Keeps Bedding Dry Keeps Kids and Lambs Safe from Mothers

STANDARD PENS

Easy carry pens are durable and lightweight!



This unique lambing/kidding pen system has been used by top sheep/goat producers. The standard heavy steel constructed pens are easily pinned together for fast assembly. The 18" safety zone protects lambs/kids from ewes/does and provides a dry bedding area. The feed creep panel allows ewes/does to feed and water outside of pens. Begin with a starter pen and use the add-on pens to make a customized connected row of lambing/kidding pens.

Durable Construction

Heavy steel construction is standard with Sydell pens. Sturdy zinc plated drop pins make for easy assembly of panels.



- Feed front panel
- Warming/safety zone
- Pails and brackets included.
- Wall mount brackets included for wall mount models.

FREESTANDING PENS



112A
STARTER PEN

Pail brackets & buckets included



112B
ADD-ON PEN

Feed Front Panel

Available in 4' x 6' and 5' x 6' options.
4' x 6' option pictured.

STANDARD FREESTANDING PENS

ITEM	SIZE	PRICE
Starter Freestanding Pens		
Includes 2-223, 2-220, 2-400, 2-600, 1-450, Drop Pins		
112A	6' x 4' x 42"	\$755
113A	6' x 5' x 42"	\$825
Add-On Freestanding Pens		
Includes 2-223, 2-220, 2-400, 1-600, 1-450, Drop Pins		
112B	6' x 4' x 42"	\$585
113B	6' x 5' x 42"	\$655

STANDARD WALL MOUNT PENS

ITEM	SIZE	PRICE
Starter Wall Mount Pens		
Includes 2-223, 2-220, 2-400, 2-600, 2-620T, Drop Pins		
102A	6' x 4' x 42"	\$685
103A	6' x 5' x 42"	\$735
Add-On Wall Mount Pens		
Includes 2-223, 2-220, 2-400, 1-600, 1-620T, Drop Pins		
102B	6' x 4' x 42"	\$485
103B	6' x 5' x 42"	\$535

WALL MOUNT PENS



102A
STARTER PEN

Zinc Plated Drop Pin

Wall Mount Brackets

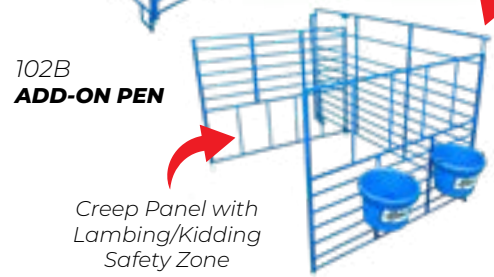

102B
ADD-ON PEN

Creep Panel with Lambing/Kidding Safety Zone

PANELS & ADD-ONS

Essential add-ons make work easier!

SIDE PANEL



600A-6T \$170

BACK PANELS



450-4T \$130



450-5T \$150

FRONT/ CREEP PANELS

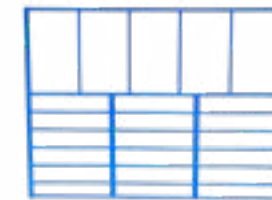

400-4T \$120



400-5T \$145

GRAFTING GATE



460-5T \$230

2 sizes available

TRAY FOR SUPPLIES



946P \$130

PANELS

ITEM	SIZE	PRICE
Divider Panels		
600A-6T	6' Divider Panel - 73 1/2" Wide x 42" Tall	\$170
All Bar Panels w/2 Drop Pins		
450-4T	4' All Bar Panel - 47" Wide x 35 5/16" Tall	\$130
450-5T	5' All Bar Panel - 59" Wide x 35 5/16" Tall	\$150
Feed Creep Panels w/2 Drop Pins		
400-4T	4' Feed Creep Panel - 47" Wide x 35 5/16" Tall	\$120
400-5T	5' Feed Creep Panel - 59" Wide x 35 5/16" Tall	\$145

ROLLER CREEP GATE

EWEE HEADLOCK



475 \$535



490 \$190



ADD-ONS

ITEM	DESCRIPTION	PRICE
Grafting Gates for Non-Horned and Horned Stock (drop pins included)		
460-4T	4' Grafting Gate - 47" Wide x 35 5/16" Tall	\$220
460-5T	5' Grafting Gate - 59" Wide x 35 5/16" Tall	\$230
Arched Swing Gate w/Built in Roller Creep Gate (drop pins included)		
475	4' Arched Swing Gate - 4' Wide x 6' Tall	\$535
Ewe Headlock (not for horned stock)		
490	Ewe Headlock (fits 400 panels) - 15" x 20 1/2"	\$190
Working Tray		
946P	Work Tray - 29 3/4" x 12 1/2" x 9"	\$130

PAIL & PAIL BRACKET

ITEM	DESCRIPTION	PRICE
Pail & Pail Bracket		
223	10" Heavy Duty Blue 8 Quart Pail	\$7
220	10" Diam. Pail bracket (fits 223 pail)	\$18



223 \$7



220 \$18

FOLDING STYLE PENS/PANELS

Easy and extremely versatile!



Folding style lambing pens are easy and versatile. An economical lambing/kidding pen when starting in the corner of a building. The starter 5' x 5' size pen comes complete with wall mount brackets, pails and brackets. The 650 Double Folding Panels can also be purchased separately and are our best selling, most diverse panel. This essential product for your farm has multiple uses. The easy folding, lightweight and durable panels can be used for lambing/kidding, sorting stock, or as a quick go-to around the farm.

Great Show Travel Panels

The double 650 panels are also great for traveling. The two panels fold easily and are lightweight - perfect for a travel show pen!

- Great quick creep area as shown on next page
- Most durable, lightweight, versatile panels
- Easy to setup, use and move
- Works well with hay baskets and poly feeders

WALL MOUNT PEN

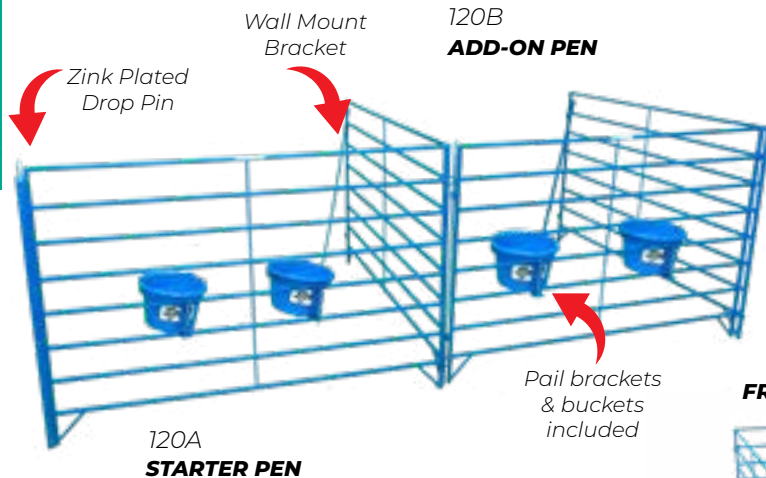

120B
ADD-ON PEN

FOLDING STYLE PANEL

ITEM	SIZE	PRICE
Starter Folding Style Pen Includes 1-650, 2-220-6, 2-223, 2-620, Drop Pins	120A 5' x 5' x 40"	\$280
Add-On Folding Style Pen Includes 1-650, 2-220-6, 2-223, 1-620, Drop Pins	120B 5' x 5' x 40"	\$250

FREESTANDING PEN

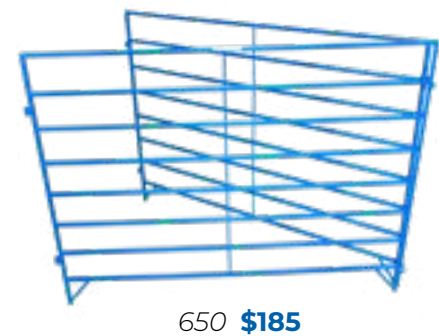

Put two sets of 650 double folding panels together for a quick pen 5' x 5' x 40"
Bar spacing is 4 1/2" apart on 650 double folding panels

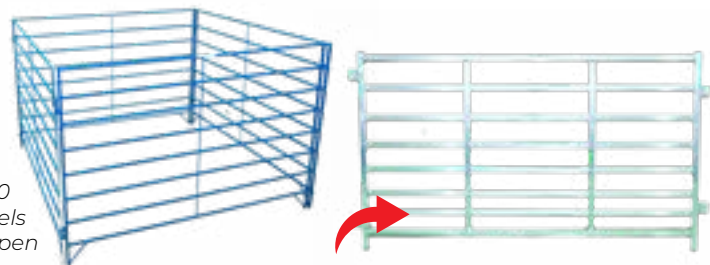

651 Panels also available in aluminum. Call for pricing.

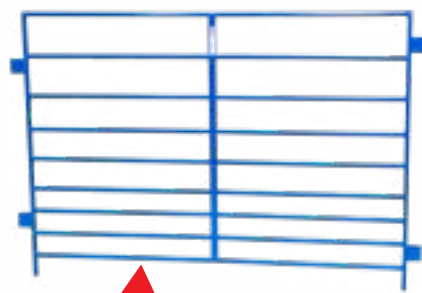

Bar spacing is 3" apart on bottom 12" of panel on all 3 sizes of 651 panels

FOLDING STYLE PANEL

ITEM	SIZE	PRICE
Panels Only w/1 Drop Pin		
650	5' Double Panels	\$185 (Get 10 for \$1,750)
651-4	4' Panel - 4' Wide x 40" Tall	\$110 (Get 10 for \$1,025)
651-5	5' Panel - 5' Wide x 40" Tall	\$120 (Get 10 for \$1,125)
651-6	6' Panel - 6' Wide x 40" Tall	\$135 (Get 10 for \$1,275)
620	Wall Mount Bracket	\$20
220-6	10" Pail Brackets (mount to 650/651)	\$18

CREEP AREA/LAMB RESTRAINT

Essential for growing healthy lambs and kids!

Make this your easiest and most productive lambing/kidding season ever with a complete creep area!

- Adjustable creep panel
- Easy to assemble, lightweight folding panels
- 400 lb. capacity self feeder
- Easy access walk thru gate

COMPLETE CREEP AREA SHOWN



SEE A LIVE VIDEO ONLINE!

COMPLETE CREEP AREA

ITEM	DESCRIPTION	PRICE
150	Complete Creep Area Includes 3-650, 1-940, 1-470-4, 1-1009P, Drop Pins Creep area w/feeder, panels, creep gate and walk-thru gate	\$1,645

POLY SELF FEEDERS

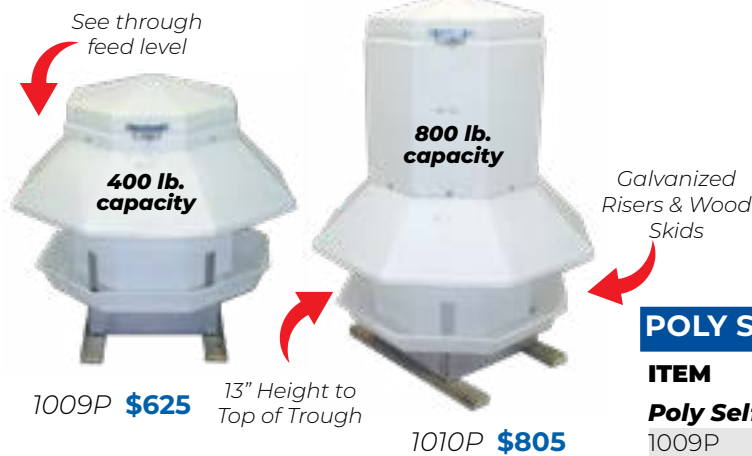

1009P \$625 13" Height to Top of Trough
1010P \$805

ROLLER CREEP PANELS



Center bar is adjustable height

Roller bars are adjustable width

470-4 \$315



475 \$535

LAMB RESTRAINT
1030 \$330

Available as panel mount

POLY SELF FEEDERS

ITEM	SIZE	PRICE
Poly Self Feeders		
1009P	400lb. Capacity - 46" Wide x 42" High	\$625
1010P	800lb. Capacity - 46" Wide x 66" High	\$805

LAMBING ESSENTIALS

ITEM	SIZE	PRICE
Adjustable Roller Creep Panels		
470-4	4' Creep Panel - 4' Wide x 42.5" Tall	\$315
470-5	5' Creep Panel - 5' Wide x 42.5" Tall	\$370
470-6	6' Creep Panel - 6' Wide x 42.5" Tall	\$435
470-8	8' Creep Panel - 8' Wide x 42.5" Tall	\$540

Arched Swing Gate w/Roller Creep Gate (drop pins included)

475	4' Gate - 4' Wide x 6'6" Tall	\$535
-----	-------------------------------	-------

Lamb Restraint

(for tail docking, ear tagging, vaccinating and castrating)

1030	Lamb & Kid Restraint with Stand	\$330
1030PM	Lamb & Kid Restraint Panel Mount	\$330

ARTIFICIAL INSEMINATION

Embryo transfer made easier!



A Laparoscopic Table makes artificial insemination and embryo transfer easier and safer for you and your stock. Table has hydraulic lifter assists and a pair of rear swivel wheels with brakes. Zinc plated for easier cleaning and maintenance.

- Adjustable bed length from 60-69"
- Horizontal bed height of 22 1/2"
- Hydraulic lifter assists make raising bed a breeze!
- All wheels swivel
- Also works for deer

First choice for Reproductive Specialists, Vets & Breeders!



929 \$1,695

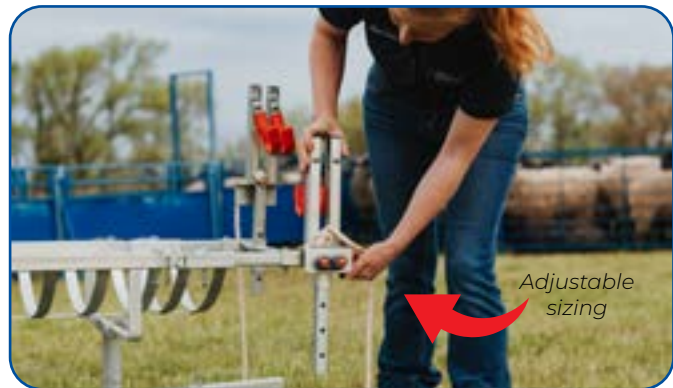

ARTIFICIAL INSEMINATION UNIT

ITEM	DESCRIPTION	SIZE	PRICE
929	Laparoscopic Table	22 1/2" bed height, 60-69" bed length	\$1,695

SHOW + FAIR PENS

Show/fair pens come in multiple sizes and options and can be customized to meet your barn or facility needs. Let us help you custom fit your facility!



SECURE CLOSURE FOR STOCK



NO PROTRUDING HANDLES OR HINGES



EASY OPEN FRONT GATES



GOOD FOR A VARIETY OF STOCK

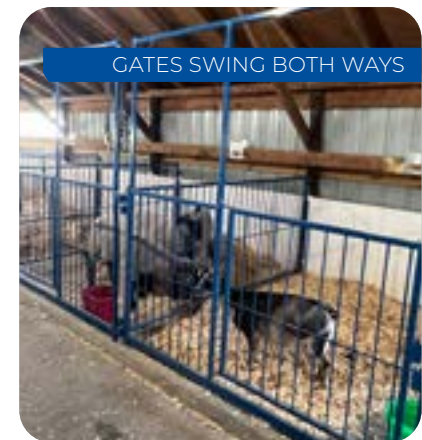

GATES SWING BOTH WAYS



MODULAR DESIGN

S VIEW OUR ENTIRE OFFERING OF SHOW AND FAIR PENS ON THE NEXT PAGE!

CUSTOM SHOW AND FAIR PENS

Great as lambing/kidding pens, and work for hogs and other livestock!



When you purchase Sydell fair and show pens, you purchase decades of research and development. Sydell fair and show pens can be found on farms, fairgrounds, universities and research facilities throughout the United States.

Sydell offers the personal touches of a small business, while its facilities combined with its skilled and experienced workforce enable the fulfillment of large and custom orders in a timely manner without sacrificing quality.



Extended Handle Option

Access gates swing both directions with extended handle for easy use with one hand.

- Streamline design and clean welds keep stock safe
- Individual panels disassemble, stack and store easily
- Select, latch or pin system - adds strength for all stock sizes
- Optional treamline, easy access handles
- Optional gates swing both directions

6' x 6' PEN WITH LATCH SYSTEM

Gate & panel frames: 1"x1" - 15 gauge tubing

Fairs & Facilities: Call for Special Bid Pricing!

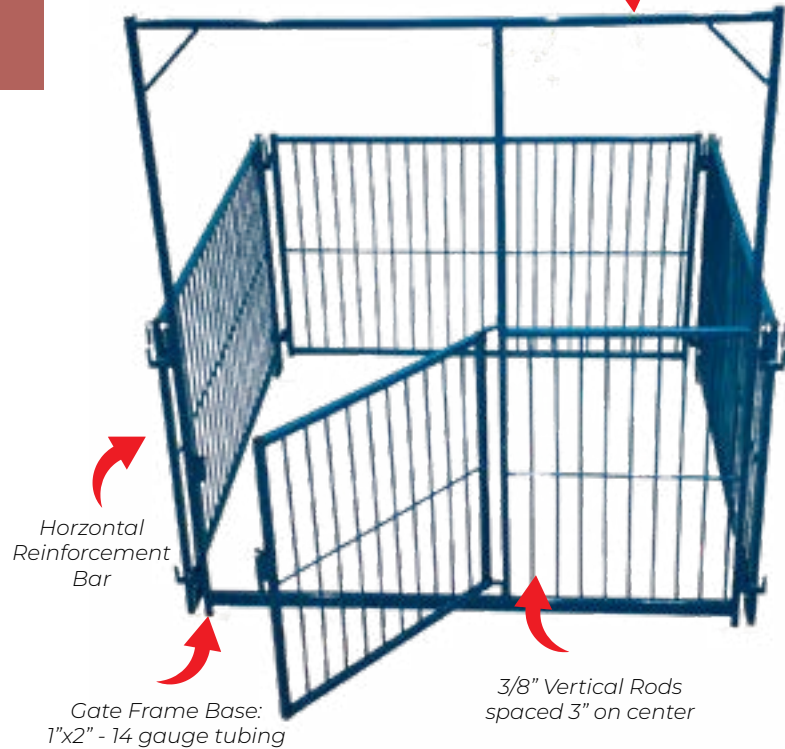

3/8" Vertical Rods spaced 3" on center



SHOW/FAIR PENS: FAIRS & FACILITIES: CALL FOR BID PRICING!

ITEM	DESCRIPTION	SIZE	PRICE
Front Panels (included special latch system where no drop pins are needed)			
FPAHG-6	6' Arched Front Panel (latch)	6' Wide x 72" Tall, 3" on center vertical spacing	\$390
FPA-6	6' Vertical Back Panel (latch)	6' Wide x 42" Tall, 3" on center vertical spacing	\$190
FPC-6	6' Vertical Side/Divider Panel (latch)	6' Wide x 72" Tall, 3" on center vertical spacing	\$250

CALL FOR BID PRICING

Bulk pricing available for fairs and facilities!

VERTICAL 6' x 6' FAIR PEN PANELS WITH DROP ROD SYSTEM

Also available in 4' & 5' lengths

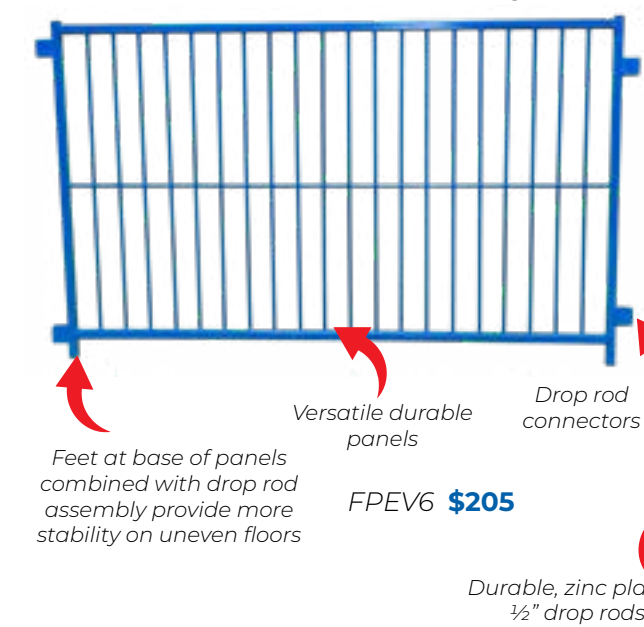

6' x 6' Front Panel

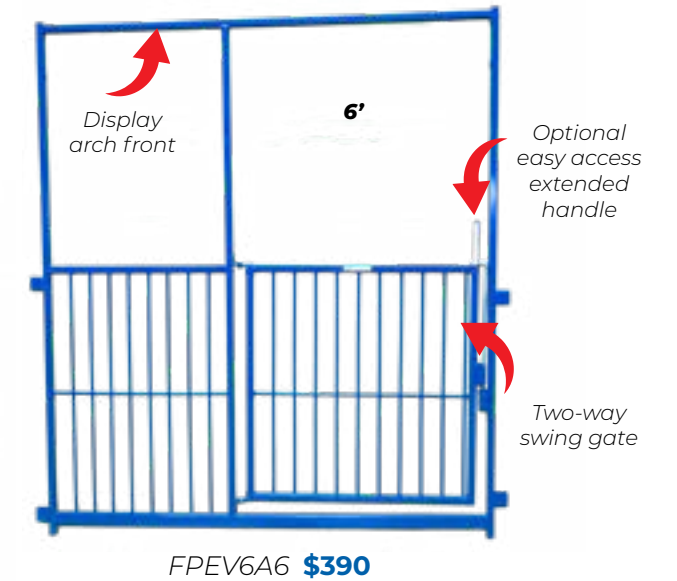

CALL FOR DETAILS!



FPWMB \$31

SHOW/FAIR PENS: FAIRS & FACILITIES: CALL FOR BID PRICING!

ITEM	DESCRIPTION	SIZE	PRICE
Arched Fronts (2 drop pins included)			
FPEV4A4	4' Arched Front	78" x 48", 3" on center vertical spacing	\$245
FPEV5A5	5' Arched Front	78" x 60", 3" on center vertical spacing	\$275
FPEV6A6	6' Arched Front	78" x 72", 3" on center vertical spacing, 3' door opening	\$390
Vertical Fair Pen Panels (2 drop pins included)			
FPEV4	4' Vertical Fair Pen Panel	4' Wide x 42" Tall, 3" on center vertical spacing	\$165
FPEV5	5' Vertical Fair Pen Panel	5' Wide x 42" Tall, 3" on center vertical spacing	\$185
FPEV6	6' Vertical Fair Pen Panel	6' Wide x 42" Tall, 3" on center vertical spacing	\$205
Accessories (hardware and drop pin not included)			
FPWMB	Wall Mount Bracket	2 1/2" x 1" x 26"	\$31

FEEDERS

Sydell products accommodate small and large facilities. Let us help you find the right products to fit your needs.



BUNK FEEDERS | PAGE 24



ROUND BALE FEEDERS | PAGE 23



SECTIONAL FEEDERS | PAGE 22



MINERAL/GRAIN FEEDERS | PAGE 21



PAIL BRACKETS | PAGE 19



HAY FEEDERS | PAGE 20



FENCELINE FEEDERS | PAGES 24-25

VIEW OUR ENTIRE OFFERING OF SYDELL FEEDERS ON PAGES 18-25!

POLY TROUGH

Easily hook on panels and move!

Poly trough feeders are easy to use, lightweight and durable. All troughs come with standard clevis hook to hang on most panels.

Standard Clevis

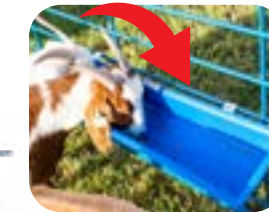

Hi-BACK FEEDER

Available in mini size

1' 1021 \$34

2' 1022 \$45

3' 1023 \$55

2' 1022-3 \$45

4' 1024-5 \$65

1024B \$48

POLY SHOW TROUGH (STANDARD CLEVIS)

ITEM	DESCRIPTION	SIZE	PRICE
1021	1' Poly Trough	16 1/2" x 10" x 5 1/4"	\$34 (Get 5 for \$155)
1022	2' Poly Trough	27" x 10" x 5 1/4"	\$45 (Get 5 for \$220)
1022-3	2' Poly Trough w/3 compartments	27" x 10" x 5 1/4"	\$45
1023	3' Poly Trough	40" x 10" x 5 1/4"	\$55 (Get 5 for \$260)
1024	Hi Back Feeder	26 1/4" x 17 1/4" x 7 1/4" & 13 1/4"	\$70
1024-5	4' Poly Trough w/5 compartments	48 1/2" x 10" x 5 1/4"	\$65
1024B	Box Feeder	14 1/2" x 14 1/4" x 8 1/2"	\$48
1024M	Mini Hi Back Poly Feeder	15" x 15" x 7 1/4" & 11"	\$45
201-2C	Clevis		\$12



Save with mix & match 5 and 10 packs!



236 - 237 - 238 \$25



223 \$7 220 \$18

10" SHOW PAILS & BRACKETS

ITEM	DESCRIPTION	SIZE	PRICE
236	12" Deluxe Pail Bracket (paint finish)	10" Ring, 12" Tall	\$25
237	20" Deluxe Pail Bracket (paint finish)	10" Ring, 20" Tall	\$25
238	28" Deluxe Pail Bracket (paint finish)	10" Ring, 28" Tall	\$25
Mix & Match 236, 237 & 238 to Save: Get 5 for \$120 or 10 for \$220!			
223	10" Heavy Duty Blue Pail	8 Quart	\$7
220	10" Pail bracket (fits 223 pail)	10" Diameter	\$18

5-GALLON PAIL BRACKETS

ITEM	DESCRIPTION	SIZE	PRICE
246	12" 5-Gallon Pail Bracket	12" Ring, 12" Tall	\$30
247	20" 5-Gallon Pail Bracket	12" Ring, 20" Tall	\$30
248	28" 5-Gallon Pail Bracket	12" Ring, 24" Tall	\$30

Mix & Match 246, 247 & 248 to Save: Get 5 for \$130 or 10 for \$250!

3 Sizes
246 - 247 - 248 \$30



HAY & GRAIN FEEDERS

Some of our most popular feeders!



These items are a staple in most operations. Whether it's a poly hay grain feeder or a steel hay basket, Sydell has feeding time covered.

22" WIDTH

Optional galvanized insert or lid



202 \$185

201L \$195

201 \$150

45" WIDTH



206 \$250

207 \$315

204P \$65

POLY HAY GRAIN FEEDERS

ITEM	DESCRIPTION	SIZE	PRICE
206	Poly Hay Grain Feeder w/Clevis Kit	45 1/2" x 8 1/2" x 23 1/2"	\$250
207	Poly Self Feeder w/Galvanized Insert & Clevis Kit	45 1/2" x 8 1/2" x 23 1/2"	\$315
206A	Galvanized Self Feeder Insert for 206		\$65
201L	Poly Hay Grain Feeder w/Lid	22" x 8" x 24", Lid 14" x 23"	\$195
201LID	Lid Only	14" x 23"	\$45
201A	Galvanized Insert for 201		\$35
201	Poly Hay Grain Feeder	22" x 8" x 24"	\$150 (Get 2 for \$295)
202	Poly Self Feeder w/Galvanized Insert	22" x 8" x 24"	\$185 (Get 2 for \$365)
204P	Poly Hay Basket w/Clevis Kit	20" x 11" x 21 1/2", 4" Holes	\$65 (Get 2 for \$120 or 5 for \$295)



STEEL HAY FEEDERS

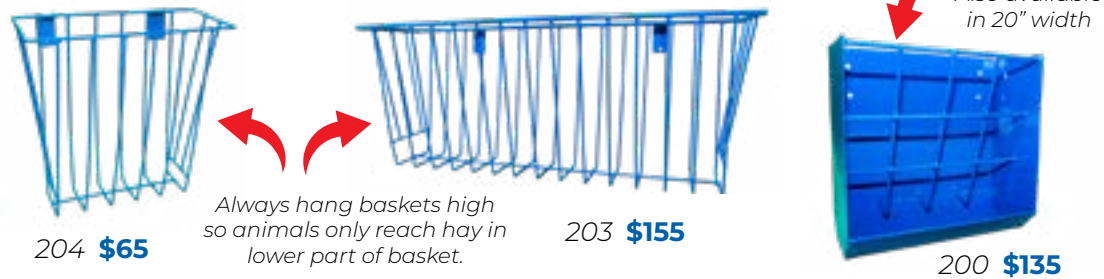

204 \$65

Always hang baskets high so animals only reach hay in lower part of basket.

203 \$155

200 \$135

Also available in 20" width

STEEL HAY GRAIN BASKETS & FEEDERS

ITEM	DESCRIPTION	SIZE	PRICE
204	Hay Basket	20" x 9" x 20 1/2"	\$65 (Get 2 for \$120 or 6 for \$360)
203	4' Hay Basket	47" x 12" x 19 3/4"	\$155 (Get 2 for \$295 or 3 for \$435)
200	Hay Grain Feeder w/Clevis Kit	16" x 8" x 16", 4" spacing	\$135
205	Hay Grain Feeder w/Clevis Kit	20" x 10 1/2" x 21", 4" spacing	\$190

SALT & MINERAL FEEDERS

Multiple capacity and base options!

Sydell Salt & Mineral Feeders come in three different tub configurations with two types of bases. Round base can be adjusted to set height that fits your stock.



25 lb. Capacity

Tub holds 25 lbs.

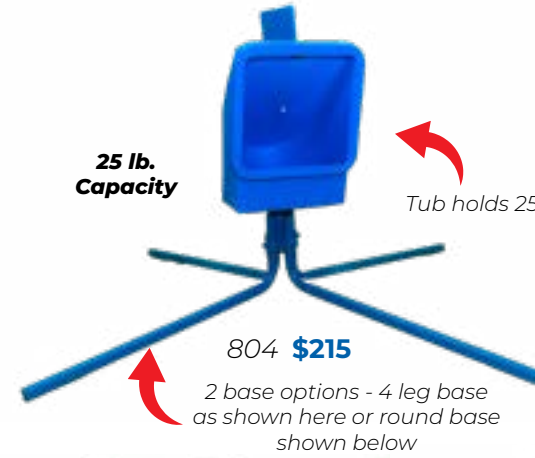

804 \$215

2 base options - 4 leg base as shown here or round base shown below



800 \$355

Each tub holds 12 lbs.

801-0 \$435

50 lb. Capacity

Recommended for horned stock!

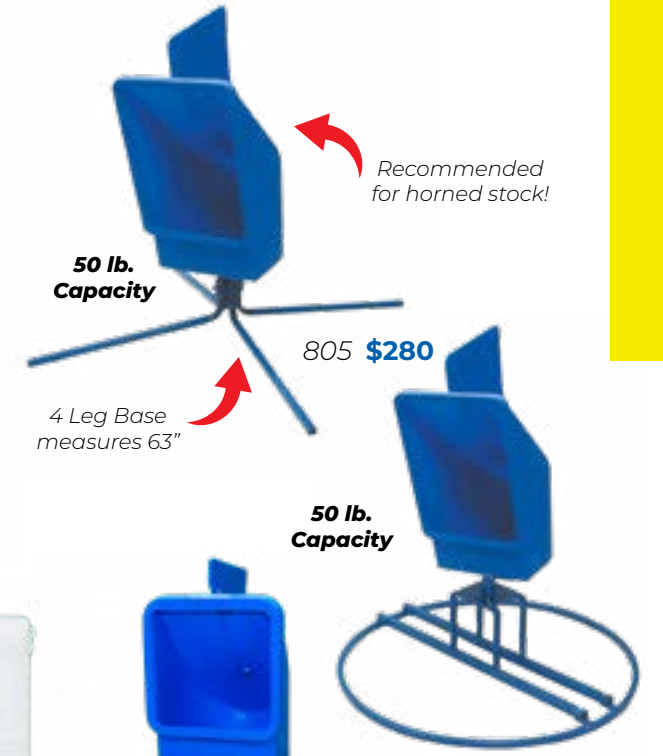

805 \$280

4 Leg Base measures 63"

50 lb. Capacity

801-5 \$370

25 lb. Capacity

801-4 \$305

Round Base is 36" diameter



MINERAL GRAIN FEEDER



1013 \$45

Features feed flow adjustment, removable lid, and visible mineral/grain level

SALT AND MINERAL FEEDERS

ITEM	DESCRIPTION	SIZE	PRICE
800	2 Tub Feeder w/4 Leg Base	15" Container Height	\$355
804	25 lb. Feeder w/4 Leg Base	12" x 12" Opening, 19" Access Height to Ground	\$215 (Get 2 for \$415)
805	50 lb. Feeder w/4 Leg Base	16" x 22" Opening, 20 1/2" Access Height to Ground	\$280 (Get 2 for \$550)
801-0	2 Tub Feeder w/Round Base	16 1/2" or 20" Access Height to Ground	\$435
801-4	25 lb. Feeder w/Round Base	12" x 12" Opening, 19" Access Height to Ground	\$305
801-5	50 lb. Feeder w/Round Base	16" x 22" Opening, 20 1/2" Access Height to Ground	\$370
1013	25 lb. Mineral Grain Feeder	10" x 4 3/4" x 27 1/4" w/Removable Lid	\$45 (Get 2/\$85 or 4/\$165)

SECTIONAL & HAY FEEDERS

Take the effort out of feeding!



Solid 1/2 " steel rod is used to produce this sturdy sectional feeder. The tub height is 16" off the ground. Tub insert is easy to clean and will save on feed loss.



SEE A LIVE VIDEO ONLINE!

SCAN ME

SECTIONAL HAY/GRAIN FEEDERS

7" Spacing

7" Spacing by 8" Height Head Opening

9" Deep Tub



812 \$370

SMALL SQUARE BALE FEEDER

812 Bale Feeder designed with horned stock in mind!



811-8 \$345



811 \$315



811P \$70

SECTIONAL FEEDERS

ITEM	DESCRIPTION	SIZE	PRICE
811	Sectional Feeder w/Poly Tub	36" Tall x 32 1/2" Diameter	\$315 (Get 3 for \$925)
811-8	Sectional Feeder w/8" Openings	36" Tall x 32" Diameter	\$345 (Get 3 for \$1,015)
811P	Poly Tub Only for 811		\$70
812	Small Square Bale Feeder	24" x 24" x 42"	\$370

HAY PANELS



880 \$285



881 \$290

Designed for horned stock

HAY FEEDERS

ITEM	DESCRIPTION	SIZE	PRICE
880	Hay Panel w/Slant Openings and 2 Drop Pins	8' x 42", 7 1/4" Spacing	\$285
881	Hay Panel w/Horizontal Opening and 2 Drop Pins	8' x 42", 9" Spacing	\$290

SELF & ROUND BALE FEEDERS

Various configurations to meet your needs!

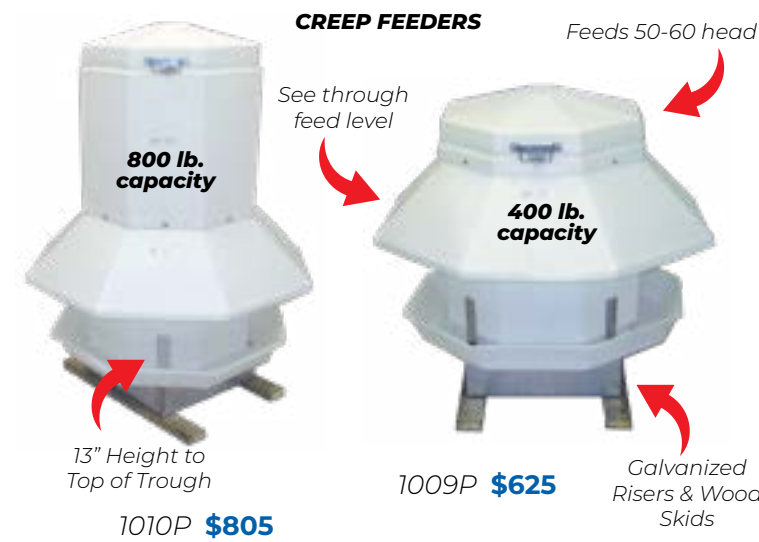

CREEP FEEDERS

Feeds 50-60 head

See through feed level

13" Height to Top of Trough

1010P \$805

1009P \$625

Galvanized Risers & Wood Skids



SEE A LIVE VIDEO ONLINE!

SCAN ME

SELF FEEDERS

ITEM	DESCRIPTION	SIZE	PRICE
1009P	400 lb. Poly Self Feeder	42" High	\$625
1010P	800 lb. Poly Self Feeder	46" x 42", 13" Trough	\$805



887 Big Square Bale Feeder \$765

LARGE BALE FEEDERS

Panels slide in for access to every last bit of hay!

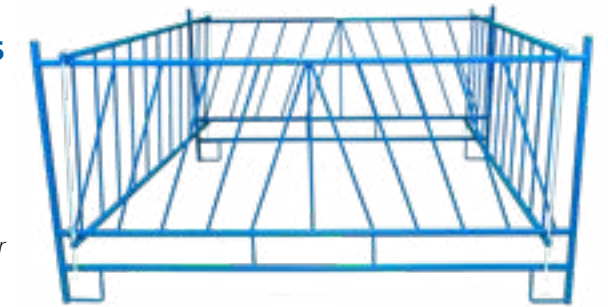

885 \$685



Round Bale Feeder

Horizontal bar designed for horned stock



886 \$730

ROUND BALE FEEDERS

ITEM	DESCRIPTION	SIZE	PRICE
884	Collapsible Big Square Bale Feeder (diagonal opening)	90" x 111" x 48", 7 1/4" Spacing	\$740
885	Collapsible Round Bale Feeder (diagonal opening)	90" x 85" x 48", 7 1/4" Spacing	\$685
886	Collapsible Round Bale Feeder (horizontal opening)	90" x 85" x 48", 8" Spacing	\$730
887	Collapsible Big Square Bale Feeder (horizontal opening)	90" x 111" x 48", 8" Spacing	\$765

HORIZONTAL BAR FEEDERS

Producers' choice for horned stock!



SEE A LIVE VIDEO ONLINE!

FENCELINE FEEDERS

Adjustable horizontal rails



817HP \$795

Add on to a starter section to customize your fence line feeder length.

Adjustable leg height

TROUGH FEEDERS

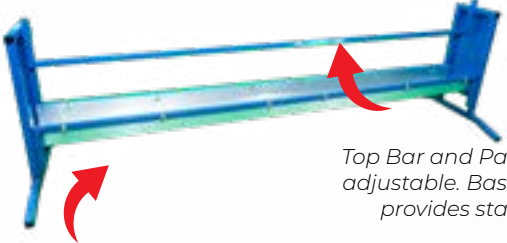

V-trough design keeps kids/lambs from standing in trough.

852F \$345

Top Bar and Pan height adjustable. Base design provides stability



852V-4 \$320

2-SIDED FEEDER



826HP \$1,010



HORIZONTAL FEEDERS

ITEM	DESCRIPTION	SIZE	PRICE
Starter Horizontal Bar Fenceline Feeders (See 817HP photo above for style)			
815HP	4' Starter Fenceline Feeder w/Poly Pan	25 1/2" x 49 1/4" x 42-50"	\$595
817HP	8' Starter Fenceline Feeder w/Poly Pan	25 1/2" x 97 1/4" x 42-50"	\$795
Add-on Horizontal Bar Fenceline Feeders (Add these to your starter feeders to lengthen your fenceline feeder)			
816HP	4' Add-on Fenceline Feeder w/Poly Pan	25 1/2" x 49 1/4" x 42-50"	\$415
818HP	8' Add-on Fenceline Feeder w/Poly Pan	25 1/2" x 97 1/4" x 42-50"	\$615
2-Sided Horizontal Bar Combination Feeders (See 826HP above for style)			
824HP	4' Combination Feeder w/Poly Pan	25 1/2" x 49 1/4" x 42-50"	\$725
826HP	8' Combination Feeder w/Poly Pan	25 1/2" x 97 1/4" x 42-50"	\$1,010
Grain Feeders			
852F-4	4' Grain Feeder w/Flat Grain Trough	11 1/2" - 17 1/2" Pan Height	\$305
852V-4	4' Grain Feeder w/V Grain Trough	11 1/2" - 17 1/2" Pan Height	\$320
852F	8' Grain Feeder w/Flat Grain Trough	11 1/2" - 17 1/2" Pan Height	\$345
852V	8' Grain Feeder w/V Grain Trough	11 1/2" - 17 1/2" Pan Height	\$360

VERTICAL BAR FEEDERS

Features adjustable legs and 3" spacing!

2-SIDED FEEDER



Feed hay on top and catch waste in pan

824P \$695

Adjustable leg height



826P \$995



817P \$795

Start with a 4' or 8' starter section, add-on sections as needed.



SEE A LIVE VIDEO ONLINE!



VERTICAL FEEDERS

ITEM	DESCRIPTION	SIZE	PRICE
Starter Vertical Bar Fenceline Feeders (See 817P above for style)			
815P	4' Starter Fenceline Feeder w/Poly Pan	25 1/2" x 49 1/4" x 42-50", 3" Spacing	\$580
817P	8' Starter Fenceline Feeder w/Poly Pan	25 1/2" x 97 1/4" x 42-50", 3" Spacing	\$795
Add-on Vertical Bar Fenceline Feeders (Add these to your starter feeders to lengthen your fenceline feeder)			
816P	4' Add-on Fenceline Feeder w/Poly Pan	25 1/2" x 49 1/4" x 42-50", 3" Spacing	\$395
818P	8' Add-on Fenceline Feeder w/Poly Pan	25 1/2" x 97 1/4" x 42-50", 3" Spacing	\$620
2-Sided Vertical Bar Combination Feeders (See 824P/826P above for style)			
824P	4' Combination Feeder w/Poly Pan	25 1/2" x 49 1/4" x 42-50", 3" Spacing	\$695
826P	8' Combination Feeder w/Poly Pan	25 1/2" x 97 1/4" x 42-50", 3" Spacing	\$995

FENCELINE FEEDER TOP



FENCELINE FEEDER TOPS

ITEM	DESCRIPTION	SIZE	PRICE
815TOP	815 Fenceline Feeder Starter Top	4'	\$245
816TOP	816 Fenceline Feeder Add-on Top	4'	\$210
817TOP	817 Fenceline Feeder Starter Top	8'	\$350
818TOP	818 Fenceline Feeder Add-on Top	8'	\$315

CUSTOM EQUIPMENT

Whether you're looking for a custom corral system, a specialized piece of equipment or you're trying to outfit a facility, our team is here to help. Talk to our design team today to make your vision come to life.

LET OUR
TEAM HELP
YOU OUT!

WORKING SYSTEMS

Work the safe way for both you and your stock with Sydell corral systems. We have over 40 years of experience to ensure systems are safer and more efficient.



UNIQUE EQUIPMENT



EDUCATIONAL/RESEARCH FACILITIES



SPIN DOCTOR | PAGE 40-41



TILT TABLE | PAGES 42-43



CHUTE SYSTEMS



CUSTOM FEEDERS



COMPLETE CORRAL SYSTEMS | PAGES 28-32



HEADGATES & CAGES | PAGE 37



CUSTOM GALVANIZED PENS



CUSTOM PANELS



DROP TOP PANELS | PAGE 34



SORTING GATES | PAGE 33

VIEW OUR ENTIRE OFFERING OF WORKING SYSTEMS ON PAGES 28-39!

COMPLETE CORRAL SYSTEMS

Take the work out of working stock!

991 SYSTEM A



50'5" Long x 21'8" Wide

- System enables producers to work stock safer with fewer people.
- Slide/swing gate enables one person to easily push stock through system.



SEE A LIVE VIDEO ONLINE!

SCAN ME

992 SYSTEM B



34'6" Long x 14' Wide

- Two-way sort gate allows easy sorting of stock.
- Guillotine gate can be operated with rope from a distance by a single person operator.



SEE A LIVE VIDEO ONLINE!

SCAN ME

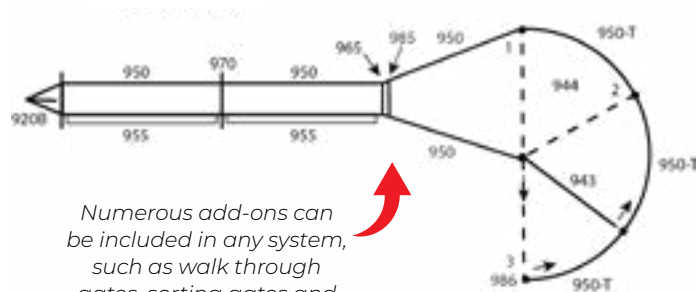
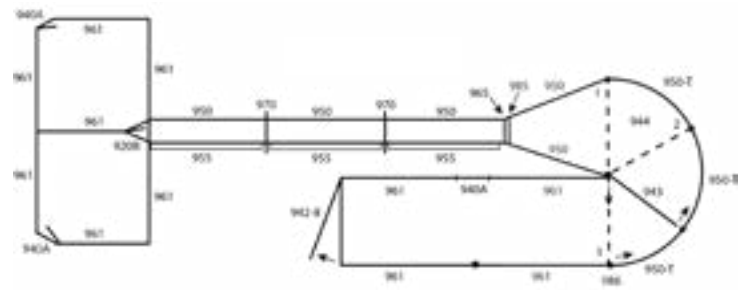

Numerous add-ons can be included in any system, such as walk thru gates, sorting gates and drop down panels.

991 SYSTEM A | \$8,675

QTY	MODEL	DESCRIPTION
1	920B	2-Way Sort with 980A
3	940A	Walk Thru Gates
1	942-8	Arched 8' Swing Gate
1	943-8	8' Slide/Swing Gate
1	944	Tub Supports #1, #2 and #3
5	950	8' Solid Corral Panels
3	950-T	8' Curved Tub Panels
3	955	8' Solid Panels with 12" Drop Top
11	961	8' Open Corral Panels with 1/2" Rods
1	965A	Flat Anti-Backup Plate
2	970A	Corral Support Stands
1	985A	Guillotine Gate
1	986	Rope Support (Telescoping)

992 SYSTEM B | \$4,295

QTY	MODEL	DESCRIPTION
1	920B	2-Way Sort with 980A
1	943-8	8' Slide/Swing Gate
1	944	Tub Supports #1, #2 and #3
4	950	8' Solid Corral Panels
3	950-T	8' Curved Tub Panels
2	955	8' Solid Panels w/12" Drop Top
1	965A	Flat Anti-Backup Plate
1	970A	Corral Support Stand
1	985A	Guillotine Gate
1	986	Rope Support (Telescoping)

COMPLETE CORRAL SYSTEMS

Add a Spin Doctor to any system for ultimate functionality!

993 SYSTEM C



27'5" Long x 8' Adjustable Width

- Easily sort stock with standard 2-way sort, or add 3-way sort.
- Add Spin Doctor or Tilt Table to any system.



SEE GUILLOTINE GATE VIDEO!

SCAN ME

994 SYSTEM D



26'9" Long x 10'5" Wide

- Add drop top panels for easy access to stock
- Incorporate foot baths with any system



SEE 2-WAY SORT VIDEO!

SCAN ME

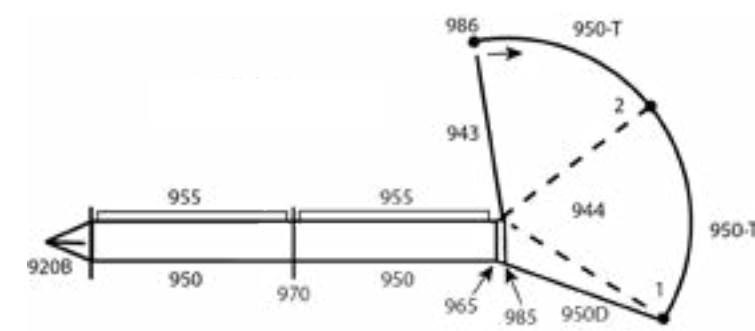
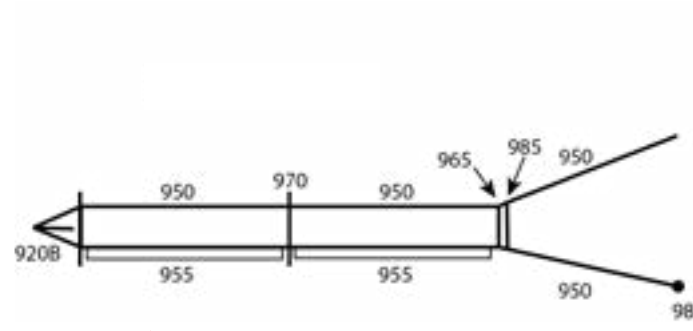

Sydell corral systems are modular, so you can design almost any style of system to best suit your needs!

993 SYSTEM C | \$2,825

QTY	MODEL	DESCRIPTION
1	920B	2-Way Sort with 980A
4	950	8' Solid Corral Panels
2	955	8' Solid Panels with 12" Drop Top
1	965A	Flat Anti-Backup Plate
1	970A	Corral Support Stand
1	985A	Guillotine Gate
1	986	Rope Support (Telescoping)

994 SYSTEM D | \$3,715

QTY	MODEL	DESCRIPTION
1	920B	2-Way Sort with 980A
1	943-8	8' Slide/Swing Gate
1	944D	Tub Supports #1 and #2
2	950	8' Solid Corral Panels
1	950D	Solid Special Length for System D
2	950-T	8' Curved Tub Panels
2	955	8' Solid Panels with 12" Drop Top
1	965A	Flat Anti-Backup Plate
1	970A	Corral Support Stand
1	985A	Guillotine Gate
1	986	Rope Support (Telescoping)

COMPLETE CORRAL SYSTEMS

Safer for both you and your stock!

987 SYSTEM E



20'1" Long x 9'4" Wide

- Maintain animal health with Spin Doctor
- See Spin Doctor features on p. 40-41

988 SYSTEM F



38'3" Long x 7'10" Wide

- See p. 42-43 for Tilt Table features
- Adjustable lane width option allows adjustment of base to 6", 12" or 18" so stock won't turn around - requires 980 or 985 gate in system

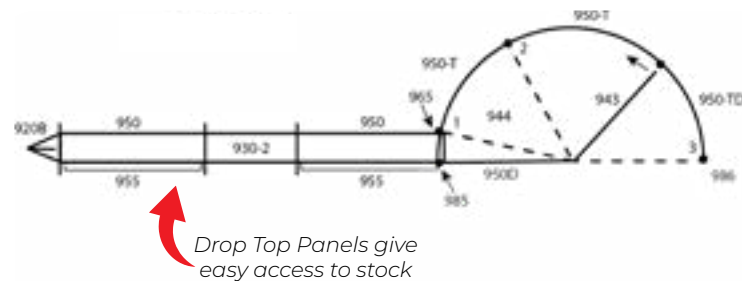
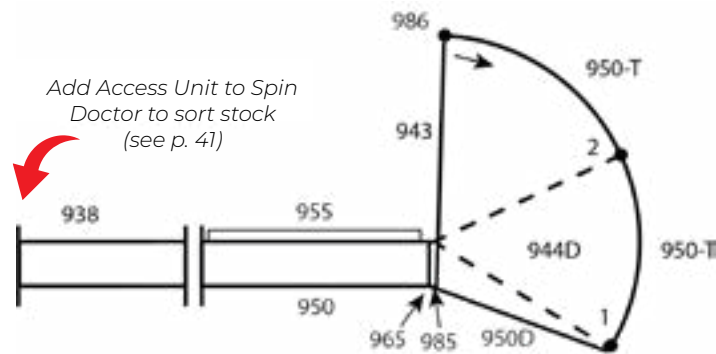

988 SYSTEM F | \$5,835

QTY	MODEL	DESCRIPTION
1	930-2	Tilt Table
1	920B	2-Way Sort with 980A
1	943-8	8' Slide/Swing Gate
1	944	Tub Supports #1, #2 and #3
2	950	8' Solid Corral Panels
1	950D	Solid Special Length System D
2	950-T	8' Curved Tub Panels
1	950-TD	Short Curved Panel for 989 Tub
2	955	8' Solid Panels w/12" Drop Top
1	965A	Flat Anti-Backup Plate
1	985A	Guillotine Gate
1	986	Rope Support (Telescoping)

987 SYSTEM E | \$6,450

QTY	MODEL	DESCRIPTION
1	938-2	Deluxe Spin Doctor
1	943-8	8' Slide/Swing Gate
1	944D	Tub Supports #1 and #2
1	950	8' Solid Corral Panel
1	950D	Solid Special Length for System D
2	950-T	8' Curved Tub Panels
1	955	8' Solid Panel with 12" Drop Top
1	965A	Flat Anti-Backup Plate
1	985A	Guillotine Gate
1	986	Rope Support (Telescoping)

COMPLETE CORRAL SYSTEMS

An essential tool for managing your stock!

989 SYSTEM G



31'6" Long x 7'10" Wide

- Anti-backup plate keeps stock moving forward (see p. 38)
- Add holding pens to any system (see p. 32)
- Foot bath and work tray are add-on options (see p. 38)

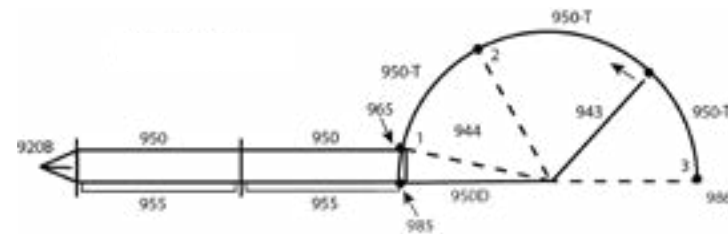

NOTE: Working alley base has width settings of 6", 12" and 18". Either sliding alleyway gate (980) or guillotine gate (985) needs to be used with sorting gates to obtain 6" or 12" width.

989 SYSTEM G | \$3,990

QTY	MODEL	DESCRIPTION
1	920B	2-Way Sort with 980A
1	943-8	8' Slide/Swing Gate
1	944	Tub Supports #1, #2 and #3
2	950	8' Solid Corral Panels
1	950D	Solid Special Length for System D
2	950-T	8' Curved Tub Panels
1	950-TD	Short Curved Panel for 989 Tub
2	955	8' Solid Panels with 12" Drop Top
1	965A	Flat Anti-Backup Plate
1	970A	Corral Support Stand
1	985A	Guillotine Gate
1	986	Rope Support (Telescoping)



The following units can be used in any working system as an essential tool to manage stock:

- 925A 3-Way Sort w/Sliding Gate (page 33)
- 930 Tilt Table (page 42)
- 938 Deluxe Spin Doctor (page 40-41)
- 971 Complete Cage Unit (page 37)
- 1001B/1006C Scale (page 39)



COMPLETE CORRAL SYSTEMS

Add-on pens and tubs for any corral system!

991 HOLDING PEN

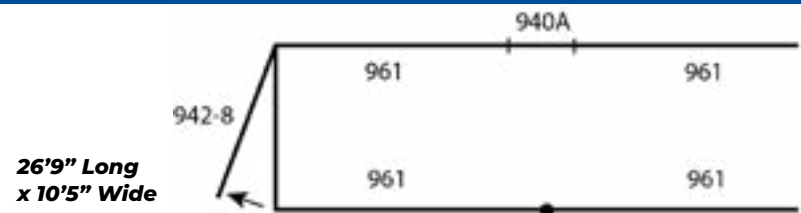

991 HOLDING PEN | \$1,710

QTY	MODEL	DESCRIPTION
4	961	8' Open Corral Panels with 1/2" Rods
1	942-8	Arched 8' Swing Gate
1	940A	Walk Thru Gates

992 TUB SYSTEM



- Tub system size can be increased as your herd/flock size increases
- Slide/Swing gate gently rolls around top of tub to push stock into system making it a one-person job
- Slide the gate back out to easily start the process over again

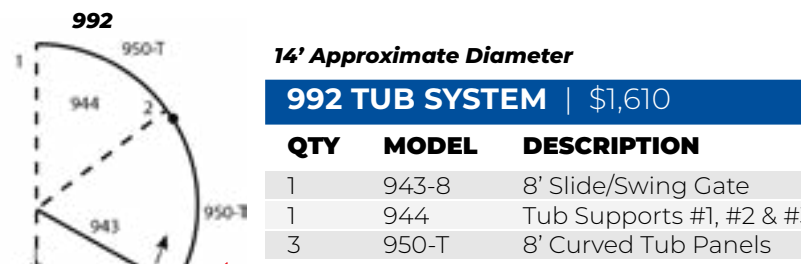

992 TUB SYSTEM | \$1,610

QTY	MODEL	DESCRIPTION
1	943-8	8' Slide/Swing Gate
1	944	Tub Supports #1, #2 & #3
3	950-T	8' Curved Tub Panels

994 TUB SYSTEM

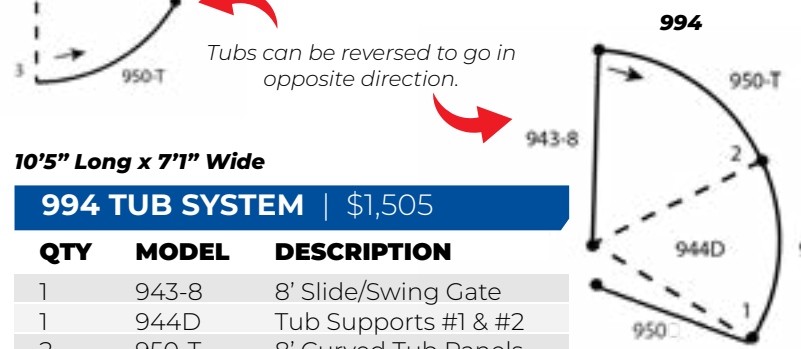

994 TUB SYSTEM | \$1,505

QTY	MODEL	DESCRIPTION
1	943-8	8' Slide/Swing Gate
1	944D	Tub Supports #1 & #2
2	950-T	8' Curved Tub Panels
1	950D	Special Solid Panel D

989 TUB SYSTEM

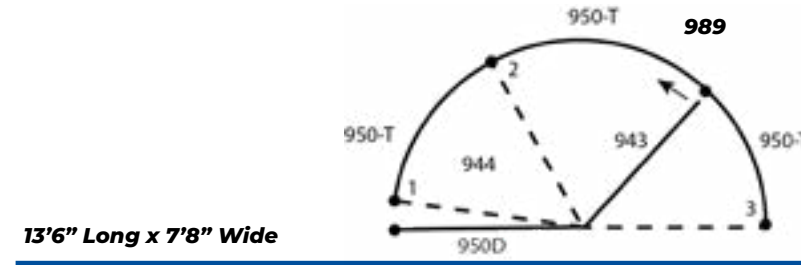

989 TUB SYSTEM | \$1,780

QTY	MODEL	DESCRIPTION
1	943-8	8' Slide/Swing Gate
1	944	Tub Supports #1, #2 & #3
2	950-T	8' Curved Tub Panels
1	950-TD	Short Curved Panel for 989 Tub
1	950D	Special Solid Panel D

SORTING GATES

Easily operated with single handles!

SLIDING GATE

980 \$295

STOP GATE

981 \$295

GUILLOTINE GATE

985A \$295

Watch this video to see how easy sorting can be with our Guillotine Gate.

SCAN ME

SEE A LIVE VIDEO ONLINE

STOP GATES

ITEM	DESCRIPTION	SIZE	PRICE
980	Sliding Alleyway Gate (61" width needed to operate)	42 1/4" x 6" x 45"	\$295
981	Stop Gate w/Alley Conversion Kit	20" x 53"	\$295
985A	Guillotine Gate	20" x 6'6"	\$295

2-WAY SORT

910 \$345

2-WAY SORT W/BIFOLD

920A \$590

BIFOLD GATE

900A \$250

2-WAY SORT W/SLIDING GATE

920B \$635

DELUXE 2-WAY SORT

921 \$440

SCAN ME

SEE A LIVE VIDEO ONLINE!

TWO WAY SORTING GATES

ITEM	DESCRIPTION	SIZE	PRICE
900A	Bifold Gate	21" x 5 1/2" x 42"	\$250
910	2-Way Sorting Gate	20 1/4" x 30 1/2" x 42"	\$345
920A	2-Way Sort w/Bifold	35 1/4" x 20 1/2" x 42"	\$590
920B	2-Way Sort w/Sliding Alleyway Gate	42 1/2" x 36" x 45"	\$635
921	Deluxe 2-Way Sort Gate (33 1/2" width needed to operate)	25 1/2" x 29" x 48"	\$440

3-WAY SORT

915 \$525

3-WAY SORT W/BIFOLD

925 \$770

3-WAY SORT W/SLIDING GATE

925A \$815

THREE WAY SORTING GATES

ITEM	DESCRIPTION	SIZE	PRICE
915	3-Way Sorting Gate	21" x 35 1/4" x 42"	\$525
925	3-Way Sort w/Bifold	40" x 20 1/2" x 42"	\$770
925A	3-Way Sort w/Sliding Alleyway Gate	42 1/4" x 41" x 45"	\$815

SOLID CORRAL PANELS

Features allow you to access and work stock safely!



DROP TOP PANELS



Drop top panels make accessing and working stock a breeze!



955 \$350

SEE A LIVE VIDEO ONLINE!



SLIDE/SWING GATE

Enables one person to move stock from tub into system with ease

943-8 \$560

8' SOLID PANEL

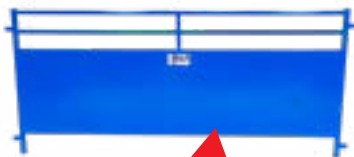

Solid, durable and versatile throughout the farm 950 \$295

SOLID CORRAL PANELS

ITEM	DESCRIPTION	SIZE	PRICE
943-8	8' Slide/Swing Gate	93 3/8" x 42"	\$560
950	8' Solid Corral Panel	96 3/4" x 42"	\$295
955	8' Solid w/12" Drop Top and 2 Drop Pins	96 3/4" x 42"	\$350
950D	Solid Special Length for System D	74 7/8" x 42"	\$250

Not pictured, visit website for photo

CURVED PANEL FOR TUB SYSTEM



950-T \$330

950-TD & 950-90 not pictured, visit website for photos

CURVED SOLID CORRAL PANELS

ITEM	DESCRIPTION	SIZE	PRICE
950-T	8' Curved Tub Panel w/2 Drop Pins	92 1/2" x 42"	\$330
950-TD	Short Curved Panel	54 1/2" x 42"	\$245
950-90	(2) 90 degree Corral Panels w/2 Drop Pins	6'5" Corner Required	\$695

WALK THRU PANEL W/RIGHT OR LEFT SIDE DOOR OPTION



950WTL \$460



950WTR \$460

WALK THRU PANEL W/DROP TOP PANEL OPTION



955WTL \$540

SOLID CORRAL PANELS W/WALK-THRU GATES

ITEM	DESCRIPTION	SIZE	PRICE
950WTL	8' Solid w/Left Walk-thru and 2 Drop Pins	96 3/4" x 42"	\$460
950WTR	8' Solid w/Right Walk-thru and 2 Drop Pins	96 3/4" x 42"	\$460
950DWTL	74 7/8" Solid w/Left Walk-thru Gate	74 7/8" x 42"	\$460
950DWTR	74 7/8" Solid w/Right Walk-thru Gate	74 7/8" x 42"	\$460
955WTL	8' Drop Top w/Left Walk-thru and 2 Drop Pins	96 3/4" x 42"	\$540
955WTR	8' Drop Top w/Right Walk-thru and 2 Drop Pins	96 3/4" x 42"	\$540

OPEN CORRAL PANELS

Easy to configure and connect how you want!

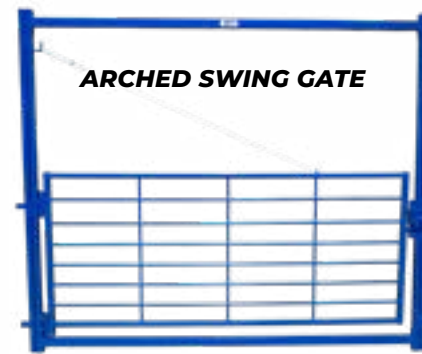

ARCHED SWING GATE

Sydell panels are versatile and easily attach together.

942-8 \$635



OPEN CORRAL PANELS

Durable and versatile throughout the farm



961-4 \$150

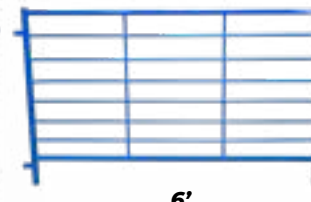

961-6 \$190

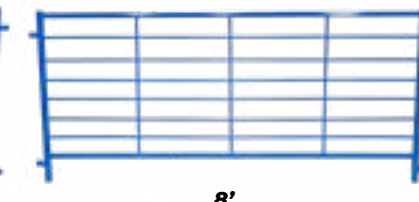

961 \$225

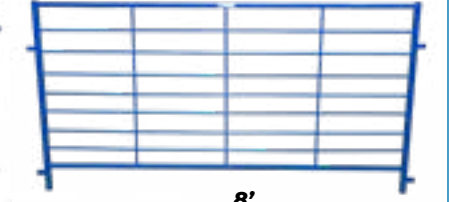

960 \$255

OPEN CORRAL PANELS

ITEM	DESCRIPTION	SIZE	PRICE
942-8	Arched 8' Swing Gate	96 3/4" x 6'6"	\$635
961	8' Open Corral 1/2" Rods w/2 Drop Pins	96 3/4" x 42"	\$225 (Get 10 for \$2,125)
961-4	4' Open Corral 1/2" Rods w/2 Drop Pins	48 3/4" x 42"	\$150 (Get 10 for \$1,375)
961-6	6' Open Corral 1/2" Rods w/2 Drop Pins	72 3/4" x 42"	\$190 (Get 10 for \$1,775)
960	8' Open Corral 1/2" Rods w/2 Drop Pins	96 3/4" x 48"	\$255 (Get 10 for \$2,395)

OPEN PANEL W/ WALK THRU GATE



961WTL \$365

Walk-thru gate is bi-directional

OPEN CORRAL PANELS W/ WALK-THRU GATES

ITEM	DESCRIPTION	SIZE	PRICE
Includes 2 drop pins			
961WTL	8' Open w/Left Walk-Thru	96 3/4" x 42"	\$365
961WTR	8' Open with Right Walk-Thru	96 3/4" x 42"	\$365

CORRAL SUPPORT



948 \$65

Use when connecting 16' or more of panels for stability and support

CORRAL SUPPORT

ITEM	DESCRIPTION	SIZE	PRICE
948	Vertical Support	36" x 42"	\$65



AL0651 Aluminum panels are lightweight and have bar spacing of 3" on bottom 12" of panel to keep stock in.

OPEN CORRAL PANELS W/WALK-THRU GATES

ITEM	DESCRIPTION	SIZE	PRICE
AL0651-4A	Aluminum Panel w/1 Drop Pin	40" x 48"	\$205 (Get 10 for \$1,950)
AL0651-5A	Aluminum Panel w/1 Drop Pin	40" x 60"	\$225 (Get 10 for \$2,125)
AL0651-6A	Aluminum Panel w/1 Drop Pin	40" x 72"	\$255 (Get 10 for \$2,440)

WALK THRU GATES

Features allow you to access and work stock safely!

Sydell walk thru gates can be easily opened and secured with one hand. The bi-directional gates also make accessing your stock and pens convenient regardless of the gate location. Can be used with most any Sydell panels and creep gates.



940 \$230



940-4 \$265



941 \$260

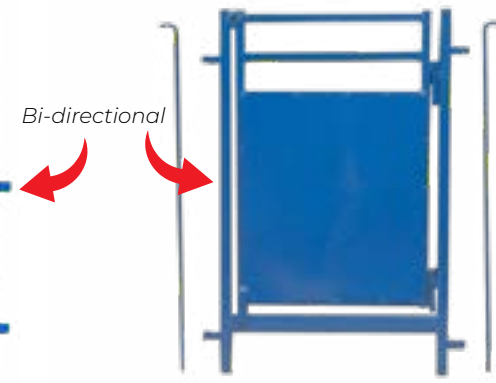

973B.5 \$205

WALK THRU GATES

ITEM	DESCRIPTION	SIZE	PRICE
940	Walk Thru Gate	30" x 42", 25 1/4" Door	\$230
940-4	4' Walk Thru Gate	48" x 42", 43 1/4" Door	\$265
941	4' Arched Walk Thru Gate	48" x 78", 40" Door	\$260
973B.5	Walk Thru Gate for Working Alley w/2 Drop Pins	30 1/4" x 42", 23 1/2" Door	\$205

ECONOMY BOLT ON HINGES (FOR WOOD PANELS)

ITEM	DESCRIPTION	PRICE
962	Economy Bolt on Hinge (set of 4)	\$25
962-5	Economy Bolt on Hinge (5 sets of 4)	\$110
962-10	Economy Bolt on Hinge (10 sets of 4)	\$210

962 \$25

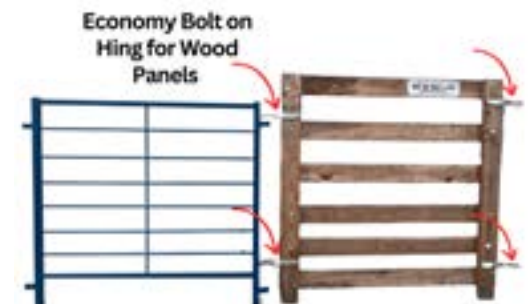

HEADGATES AND CAGES

Easily attach to working systems!



COMPLETE CAGE WITH AUTO HEADGATE



971 \$1,495

972 \$1,585

COMPLETE CAGE W/DELUXE HEADGATE

see photo of 978 below

- Safely and easily manage stock
- Easy side panel for preg checking, vaccinating and blood draws

HEAD GATES AND CAGES

ITEM	DESCRIPTION	SIZE	PRICE
971	Complete Cage (includes 974, 980, 973A, 973B)	61" x 67"	\$1,495
972	Complete Cage (includes 978, 980, 973A, 973B)	61" x 55"	\$1,585

CAGE PANEL



973A \$210

CAGE DOOR



973B \$375

DELUXE HEADGATE



978 \$740

AUTO HEADGATE

Adjustable neck width



974 \$640

HEAD GATES AND CAGES

ITEM	DESCRIPTION	SIZE	PRICE
973A	Solid Panel Door for Ewe Cage w/2 Drop Pins	40 1/2" x 42"	\$210
973B	Split Doors for Ewe Cage w/2 Drop Pins	40 1/2" x 42"	\$375
977	Single Side Auto Headgate w/Complete Ramp & Cage Unit	120" x 61" x 72"/18" Alley/30" Deck	\$2,710
978	Deluxe Headgate w/ Alley Conversion Kit	45" x 49"	\$740
974	Auto Headgate w/Adjustable Neck Width	22 1/2" x 21" x 51"	\$640

977 not pictured, visit website for photo

CORRAL TRANSPORT UNITS

Set up in less than 15 minutes!



CORRAL TRANSPORT UNIT

ITEM	DESCRIPTION	SIZE	PRICE
1901	16' Transport Unit	16' Alley w/8' Diameter Swing Tub	\$9,995
1904	16' Transport Unit	16' Alley w/8' Diameter Tub & Mounted Scale	\$11,995
1936	16' Transport Unit	16' Alley w/8' Diameter Swing Tub & Spin Doctor	\$12,700

CORRAL ADD-ONS

Accessories to consider!

TUB SYSTEM SUPPORTS

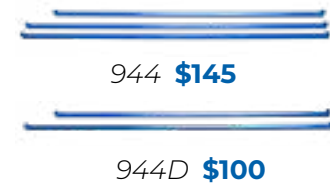

944 \$145

944D \$100

CORRAL ALLEY SUPPORT



970 \$120

DROP PINS



945 \$12

SUPPORTS & BRACKETS

ITEM	DESCRIPTION	PRICE
944	Tub Support w/3 Drop Pins Includes #1-75 1/4"L, #2-83 1/4"L, #3-83 3/4"L	\$145
944D	Tub Support (for 994 System) Includes #1-75 1/4"L, #2-83 1/4"L	\$100
970	Corral Support Stand - 41" x 42"	\$120
986	Rope Support	\$80
945	1/2" Zinc Plated Drop Pin - 1/2" x 42"	\$12

FOOT BATHS



24" x 88" (both units)
5 1/2" deep

990B \$240

ANTI-BACKUP

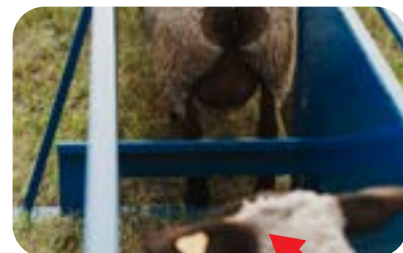

Anti Backup: prevents stock from backing up after entering working system section



965 \$60

ROPE SUPPORT



986 \$80

WORKING TRAY



946P \$130

CORRAL ADDITIONS

ITEM	DESCRIPTION	PRICE
946P	Work Tray - 29 3/4" x 12 1/2" x 9"	\$130
965	Anti-Backup	\$60
990B	Foot Baths (2 @ 17 gal each)	\$240

SYDELL SCALE UNITS & SCALES

Never guess weight when you deworm or give medications again!

SYDELL'S 1006 PLATFORM SCALE PRODUCTS AND OPTIONS

- Attach to working alleys
- Accepts 2 or 3 way sort
- Platform scales are easy and accurate
- Sydell 1006 model scales disassemble for easy transport



Hands free Bluetooth option
1006BT \$750



- 22" x 42" stainless steel platform
- 4AA Batteries or 6VDC Power Source
- Easy and lightweight to move

SEE A LIVE VIDEO ONLINE!

Sides adjust to 18", 12" or 6" at the bottom



1006C \$1,790

1006 & 1006BT

ITEM	DESCRIPTION	PRICE
1006	500 lb. Digital Scale Wired Option	\$740
1006BT	700 lb. Digital Scale Bluetooth Option	\$750
1006C	500 lb. Digital Scale w/Cage	\$1,790
1006X	Scale Cage Only w/End Gates & Sides (no scale)	\$1,180



1006X \$1,180

SYDELL'S 1001 CRANE TYPE SCALE PRODUCTS AND OPTIONS

- Optional guillotine assist
- Vertical lift gates
- 1001 model has solid construction with wheels for easy transportation
- 4 digit read out
- Rechargeable battery w/remote
- Easy electronic detachment
- 1001 models do not disassemble



1001SB \$530



Cage Size: 52" x 18" x 36 1/2"

Overall Size: 56 1/2" x 27"

SEE A LIVE VIDEO ONLINE!

1001B \$2,395



1001LR \$2,620



Guillotine assist arches

Overhead supports make use of guillotine easier.

1002 \$140

1001B & 1001SB

ITEM	DESCRIPTION	PRICE
1001B	1000 lb. Electronic Scale w/Cage & End Gates	\$2,395
1001SB	2000 lb. Electronic Scale (Scale Only) Wired Option	\$530
1001LR	2000 lb. Digital Scale w/Right & Left Hinge Doors	\$2,620
1002	Guillotine Assist	\$140

SPIN DOCTOR

The Sydell Deluxe Spin Doctor fits all sizes of stock (including horned stock) and makes maintenance easy and effortless.



ROTATING TABLE



ADJUSTS FOR ALL SIZES OF STOCK



EASY OPEN FALSE FLOOR



ACCESSIBLE SIDE PANELS



HEADGATE & STOP GATE



EASILY TRIM HOOVES AND MORE!

DELUXE SPIN DOCTOR

One of the industry's most loved Sydell products!

The Deluxe Spin Doctor is an easily rotating maintenance table that includes a deluxe headgate and stop gate. Easy to adjust top and false floor. When used, false floor drops open for easy access to hooves. Shipped assembled except foot release and head rest.

- Includes deluxe head gate and stop gate. .
- Easy to handle top adjust.
- Specify left or right head gate when ordering.
- Base width adjusts to fit your stock



SEE A LIVE VIDEO ONLINE! SCAN ME



Stop gate

Load sheep, secure headgate, rotate table

938-2 \$3,995

Not recommended for use during gestation

DELUXE SPIN DOCTOR

ITEM	DESCRIPTION	PRICE
938-2	Deluxe Spin Doctor - 83 1/4" x 46" x 64"	\$3,995



937 \$270

The Wheel Kit System is a must-have!

SEE A LIVE VIDEO ONLINE!

SPIN DOCTOR ACCESS GATE UNIT



72" x 33" x 42"

927 \$850

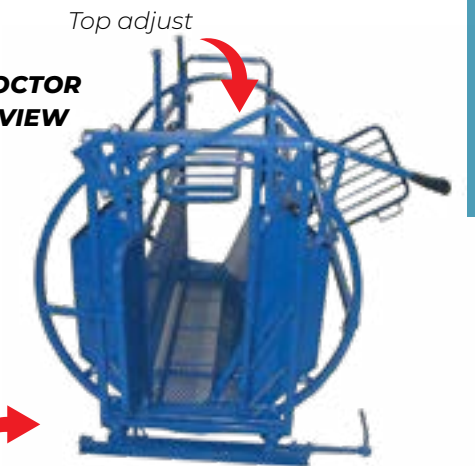

Top adjust

SPIN DOCTOR FRONT VIEW

Galvanizing optional, call for pricing.

SCALE



1004 Scale for use with Spin Doctor

1004 \$1,370

DELUXE SPIN DOCTOR ACCESSORIES

ITEM	DESCRIPTION	PRICE
937	Spin Doctor Wheel Kit	\$270
1004	Digital Scale	\$1,370
927	Spin Doctor Headgate/Access Gate Unit	\$850
937H	Hitch for 938 Deluxe Spin Doctor	\$165

937H not pictured, visit website for photo

TILT TABLE

This Sydell Tilt Table makes hoof trimming safer for you and your stock!



WORKS GREAT WITH HORNED STOCK



GRAB HANDLE & TILT



LOCK TABLE IN PLACE



EASILY ACCESS HOOVES

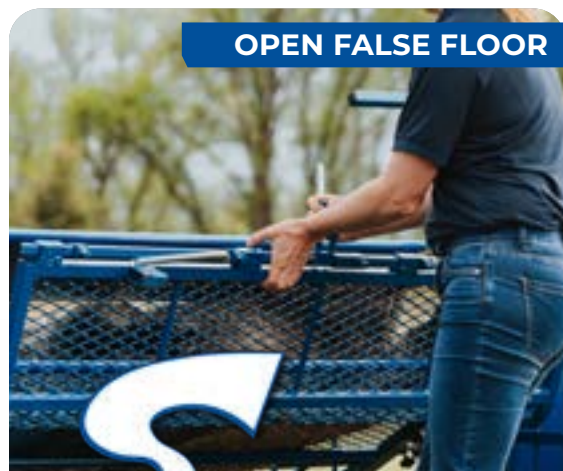

OPEN FALSE FLOOR



ADJUSTABLE FOR ALL SIZES OF STOCK

TILT TABLE

Uniquely designed for all sizes of stock!

Tilt Table features Top Adjust & False Floor. The one-hand floor release lock makes working stock easy. Tilt table is uniquely designed for all sizes of stock, and works with horned stock as well!

- 61" operational width.
- False floor swings away for trimming hooves.
- One-handed floor release/lock.



SEE A LIVE VIDEO ONLINE! SCAN ME



Years of research went into designing the perfect tilt table. Even works with horned stock!

930 \$1,995



Optional power kit makes even the largest animal easy to maneuver. Requires less strength to move even the heaviest stock. Once you use, you'll never rotate manually again!

934 \$245

TURN TABLE

ITEM	DESCRIPTION	SIZE	PRICE
930	Tilt Table w/Top Adjust and False Floor (needs 61" to operate)	75 1/2" x 48" x 44"	\$1,995
934	Tilt Table Power Kit		\$245



SHEEP CHAIR

SS0610 \$155

HOOF TRIMMERS



The best trimmers on the market!

SS0611 \$16

MAINTENANCE

ITEM	DESCRIPTION	PRICE
SS0610	Heavy Duty Sheep Chair	\$155
SS0611	PR Hoof Trimmers	\$16

SHOWMAN'S BEST STANDS

Sydell stands are American made with American steel. Count on a Sydell stand to hold up for generations of use.



HYDRAULIC STAND | PAGE 46



FOLD UP FITTING STAND | PAGE 47



WINCH BLOCKING STAND | PAGE 48

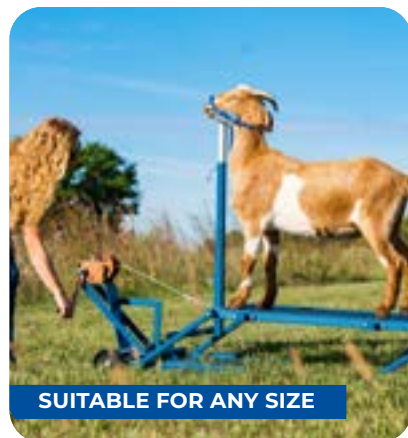

SUITABLE FOR ANY SIZE



EASY OPERATION



SHOW RAIL | PAGE 50



MILKING STANCHION | PAGE 51

THE BIG H.A.S.S.

Our Heavy-duty American Show Stand!

This heavy duty show stand features texturized steel flooring, a head piece designed to fit all sizes of stock comfortably, and a strong and stable neck reach that comfortably fits all sizes of stock. Even your largest bucks will fit comfortably on this stand. Stand works for all stock and the optional wheel kit makes it easy to move around. A go-to stand for any operation.

- Constructed with solid American steel and platform is coated with durable textured surface
- Easy to setup, use and clean
- Works well with horned stock too!
- Folds flat for easy travel
- Optional wheel kit is a must have!



THE BIG H.A.S.S.

Comfortable head piece with angle that imitates show stance.

Designed for your largest stock!

710 \$650

Large Platform 15"x22"x54"

Legs fold flat

Platform coated with durable, textured, material

American made with Solid American Steel top to bottom!"

Neck reach extends up to 50"

Horizontal mount telescopes out from base to move head piece forward.

Wide base makes stand more stable than others on the market

Head and Neck Piece

Head piece fits all stock and keeps animal secure while grooming. Angle is comfortable for the animal and imitates show stance.



WHEEL KIT ONLY

716 \$50



HEAVY DUTY SHOW STAND

ITEM	DESCRIPTION	PRICE
710	H.A.S.S. Stand w/Head Piece & Neck Reach	\$650
715	H.A.S.S. Head Piece	\$90
714	H.A.S.S. Neck Reach	\$25
716	H.A.S.S. Wheel Kit	\$50



VIEW OUR ENTIRE OFFERING OF STANDS & SHOW EQUIPMENT ON PAGES 45-53!

HYDRAULIC & PORTABLE STANDS

Easy solutions for fitting stock!



HYDRAULIC STAND WITH SHUTTLE KIT

Shown with shuttle kit & safety rails



783 \$960

Sydell hydraulic and portable stands are durable, reliable and easy to use. Made in America with American steel, this stand includes a straight neck reach and large headpiece - no need for a curved neck reach, since neck reach receiver is adjustable and extends in and out. Stands also have cast aluminum wheels for easy transport.

Decks available in aluminum. Call for pricing.



780 \$655

MILKING HEAD PIECE WITH FEEDER

HORNED STOCK STANCHION



780 Shown with 735A Stanchion w/ Poly feeder

Stanchion head piece for goats or horned stock

SAFETY RAILS



721 \$105



735 \$190



738 \$165

HYDRAULIC STAND AND OPTIONS

ITEM	DESCRIPTION	PRICE
780	Hydraulic Stand (steel) w/Large Head Piece/Neck Reach	\$655
780SHK	Shuttle Kit	\$305
721	Safety Rails w/720B Brackets for 780 Series Stands	\$105
735	Milking Head Piece w/1' Poly Feeder	\$190
738	Horned Stock Stanchion	\$165
783	Hydraulic Stand with Shuttle Kit w/Large Head Piece/Neck Reach	\$960

SHOWMAN'S BEST FITTING STAND

The best fold-up stands on the market!

Folding legs, adjustable legs and ramp accessories make Sydell's Showman's Best show stands the best on the market. Optional adjustable legs allow you to raise the front 11" higher than the back. Folds flat to make transporting easy. Optional wheel kit and ramps attach and remove effortlessly.

Available in aluminum. Call for pricing.



SEE A LIVE VIDEO ONLINE!

SCAN ME



705 \$330

FOLD UP FITTING STAND (DECK 20" x 48")

ITEM	DESCRIPTION	PRICE
705	Fold-Up Fitting Stand w/Large Head Piece/Neck Reach	\$330

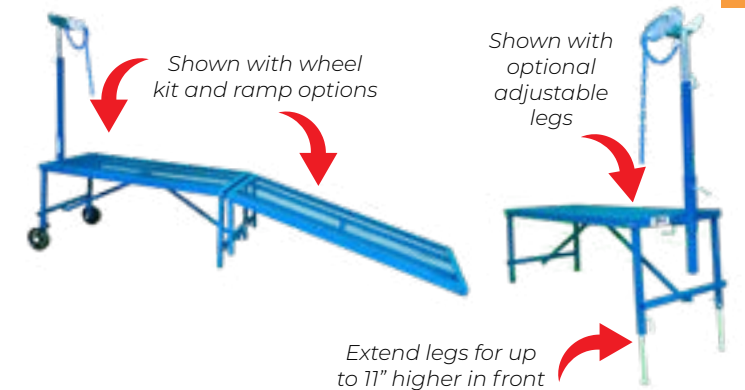

Shown with wheel kit and ramp options

Shown with optional adjustable legs

Extend legs for up to 11" higher in front

705 OPTIONAL HEAD PIECES

ITEM	DESCRIPTION	PRICE
731-S	Small Head Piece	\$60
731-L	Large Head Piece	\$60
730	Nose Loop Head Piece	\$60
714/715	H.A.S.S. Head Piece/Neck Reach	\$115



731-L/731-S \$60

730 \$60

714/715 \$115

705 FOLD UP FITTING STAND OPTIONS

ITEM	DESCRIPTION	PRICE
745WK	Wheel Kit	\$50
705R	Quick Attach Ramp	\$215
704-1	Replacement Legs	\$50
721	Safety Rails	\$105



745WK \$50



704-1 \$50



705R \$215



721 \$105

SHOWMAN'S BEST WINCH STANDS

The easier way to raise and lower stock!



SCAN ME SEE A LIVE VIDEO ONLINE!

Winch Blocking Stand makes it easy to raise and lower stock and includes wheels for easy transport. Stand includes large head piece and straight neck reach.

- Large 20" x 48" deck suitable for any size animal
- Standard deck height can be set at 4" up to 19"
- Showman's Best stands are strong & durable
- Optional 30" riser kit allows for higher platform, easier for tall people to fit the stock. Also useful with shorter stock!

Available in aluminum.

Call for pricing.

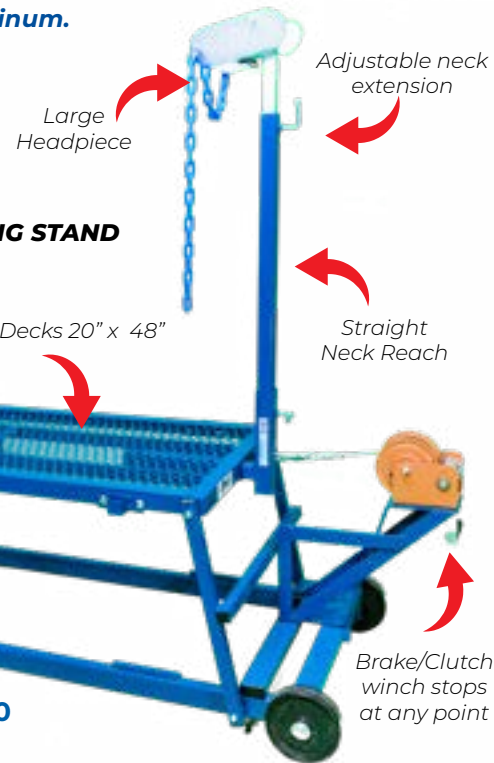

WINCH BLOCKING STAND

750 \$660



Riser kit (751) converts to 30" Height

WINCH STAND w/RISER KIT

755 \$705

Shown with Riser Kit



751 \$130

Optional Safety Rails and Alternate Head Pieces shown on page 47 also fit Sydel winch stands!

WINCH STANDS & RISER KIT

ITEM	DESCRIPTION	PRICE
750	Winch Stand w/Large Head Piece/Neck Reach	\$660
751	30" Riser Kit	\$130
755	Winch Stand w/30" Riser Kit w/Large Head Piece/Neck Reach	\$705

See page 47 for head piece options



SEE A LIVE VIDEO OF 750 WITH RISER KIT ONLINE!

SCAN ME

SHOW EQUIPMENT

Show off your stock in style!

5-HEAD SHOW RAIL WITH SIDES

Horizontal rail and head pieces have multiple adjustments in height and width. Floor is adjustable in height which adjusts angle of the floor. Breaks down for easy transportation. Sign display can be added.



CHARIOT

Unit is meant to pull behind a lawn mower or ATV. Tongue and headpieces can be flipped for ground walking.



SCAN ME SEE A LIVE VIDEO ONLINE!

743 \$835



Go to shuttle for moving Boer goats when showing

EZ RIDER



785EZN \$620

SEE A VIDEO ONLINE! SCAN ME

FOLD UP HOLDING STAND

740-JR1 \$225



729 \$70

SCAN ME SEE A VIDEO ONLINE!

SHOW EQUIPMENT

ITEM	DESCRIPTION	PRICE
740-5COMP	Complete 5-Head Show Rail	\$895
740-5	5-Head Show Rail w/sides	\$595
741-5	Show Rail Poly Floor (add to 740-5)	\$255
742	Show Rail Sign Display (add to 740-5)	\$90
743	Chariot w/4 Head Pieces	\$835
740-JR1	Single Fold-up Steel Holding Stand	\$225
785EZN	E.Z. Rider w/swivel wheels and brakes	\$620

740-JR1 available in aluminum. Call for pricing.

See page 47 for head piece options

HEAD PIECE ACCESSORIES

ITEM	DESCRIPTION	PRICE
732*	Curved Neck Reach	\$30
733*	Straight Neck Reach	\$25
740-02*	Add-on Sleeve	\$22
729	Portable Panel Mount Head Holder	\$70

*Items not pictured, visit website for photo

MILKING STANCHIONS

The best stanchions on the market!



Milking stanchions come in a variety of sizes to best fit your stock. 36" deck option is great for dwarf stock. Feeders can also be easily removed for clean up.

Available in aluminum. Call for pricing.

STANDARD MILKING STANCHION 48" DECK



1' Poly Feeder included



Fold up Stand

Stanchions available with 36" and 48" deck length for milking small and larger stock

ALO736 \$740



Shown in steel and blue paint

736 \$420

STANDARD MILKING STANCHION 36" DECK



Great for dwarf stock

HORNED STOCK STANCHION

Shown with horned stock stanchion



737 \$480

2-HEAD STANCHION W/36" DECK & BOX FEEDERS

36" x 36" Deck



18" Deck Height

1052 \$995

MILKING STANCHIONS

ITEM	DESCRIPTION	PRICE
736	48" Milking Stanchion w/Fold-up Stand & 1' Poly Feeder	\$420
736-36	36" Milking Milking Stanchion w/Fold-up Stand & 1' Poly Feeder	\$420
737	48" Horned Stock Stanchion w/Fold-Up Stand & 1' Poly Feeder	\$480
737-36	36" Horned Stock Stanchion w/Fold-Up Stand & 1' Poly Feeder	\$480
ALO736	48" Aluminum Milking Stanchion w/Fold-Up Stand & 1' Poly Feeder	\$740
1052	2-Head Stand w/2 Milking Stanchions and 2 Box Poly Feeders	\$995

MILKING STANCHION ADD-ONS

Custom options available!

STANDARD HEAD PIECES

Available in aluminum. Call for pricing.



ALO735 \$240

735 \$190



Auto Headlock with Box Feeder

HORNED STOCK HEAD PIECE

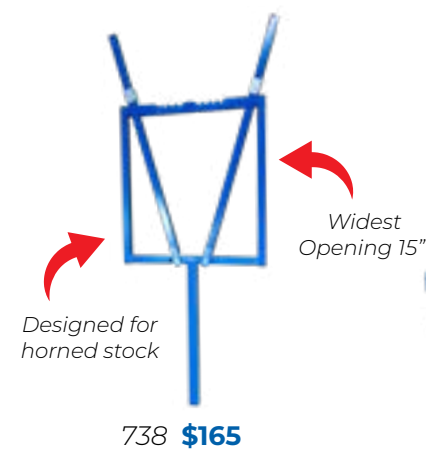

Designed for horned stock

738 \$165

AUTO HEADLOCKS



1050 \$195



1050B \$200

MILKING BENCH



736 \$105

24" Extension makes auto headlock attachable to stands

Standard Head Piece w/ 1' Poly Feeder



MILKING PARLOR



1055 \$1,575

82" Long x 68" Wide

MILKING STANCHION ADD-ONS

ITEM	DESCRIPTION	PRICE
735	Milking Head Piece w/1' Poly Feeder	\$190
736	Bench	\$105
738	Horned Stock Stanchion Only	\$165
1050	Milking Stanchion Only	\$195
1050B	Auto Head Locking w/24" Extension for Stand	\$200
1055	Self Standing Parlor Unit w/4 Box Poly Feeders	\$1,575
ALO735	Aluminum Milking Stanchion w/1' Poly Feeder	\$240

TELESCOPING PANELS

Ideal for trailers and barn doorways!



Telescoping panels are ideal for trailers and barn doorways. These panels are 96" long when extended and only 57" when closed, offering a lot of versatility to fit almost any space. Panels are also good for converting horse stalls. Door style panels feature a 24" wide door opening for easy access. Panels do not include drop pins. Panel Add ons include drop pins and trailer/wall mount brackets for easy installation.

TELESCOPING PANELS WITHOUT DOOR 48" Tall 57" to 96" Wide

Telescoping

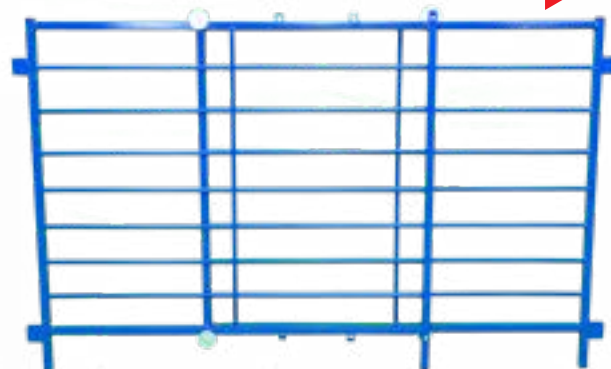

670 \$295

Telescoping

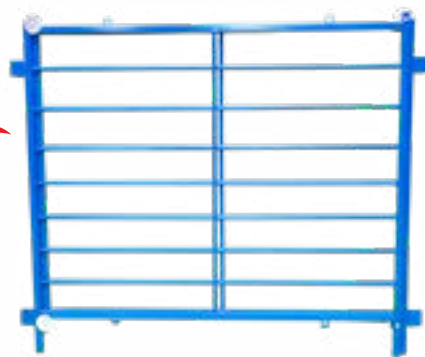

Shown at 57" wide - narrowest point

TELESCOPING PANELS WITH DOOR

Telescoping



Shown at 57" wide - narrowest point

48" Tall, 57" to 96" Wide

Telescoping

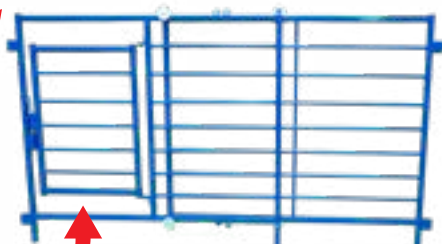

24" door

670D \$350

Door is bi-directional

Telescoping

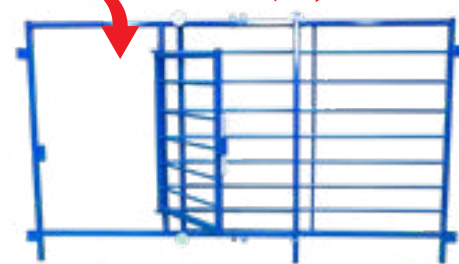

Set of 4



670WM \$55

TELESCOPING PANELS

ITEM	DESCRIPTION	PRICE
670	Telescoping Panel (drop pins not included)	\$295
670D	Telescoping Panel w/Door (drop pins not included)	\$350
670WM	Trailer/Wall Mounting Brackets (for 670 or 670D) - Set of 4	\$55

TRANSPORTATION

Making transporting stock easier!

RACKS AND CANVASES



997 Series
Price varies by size

Sliding back gate

Heavy duty canvas



997T Series
Price varies by size



Racks easily slide in the back of a pickup between the wheel wells. All racks have a sliding back gate. Heavy duty canvas tops easily slide over the 997 series pickups racks.

PORTABLE RACKS

ITEM	DESCRIPTION	PRICE
997A	48" x 96" Portable Rack for Pickups	\$895
997B	48" x 72" Portable Rack for Pickups	\$875
997C	40" x 72" Portable Rack for Pickups	\$845
997D	48" x 60" Portable Rack for Pickups	\$845

PORTABLE RACK CANVAS TOPS

ITEM	DESCRIPTION	PRICE
997TA	48" x 96" Canvas Top for 997A	\$245
997TB	48" x 72" Canvas Top for 997B	\$245
997TC	40" x 72" Canvas Top for 997C	\$245
997TD	48" x 60" Canvas Top for 997D	\$245



72" x 18" x 30"

For large/small pickups

995 \$1,335

995 LOADING RAMP

Loading ramp has flip-out extension to fit either large or small pickups.

995-8 LOADING RAMP

Fits semi-trailer first floor or it adjusts up or down for pickups and stock trailers. Very versatile ramp for loading stock.



96" x 18" x variable height

Adjustable for semis, pickups & stock trailers

995-8 \$3,125

LOADING RAMPS

ITEM	DESCRIPTION	PRICE
995	Loading Ramp w/Flip-Out Extension	\$1,335
995-8	8' loading Ramp	\$3,125

SHEARING & WATERERS

Making tasks easier!

WOOL SKIRTING TABLES



1034 **\$2,080**

Height is adjustable, Top rotates easily.

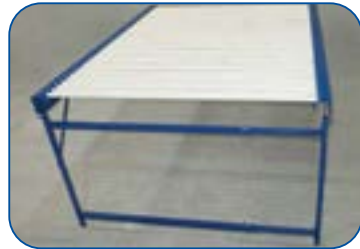

1035 **\$895**

All skirting tables fold for easy transport!

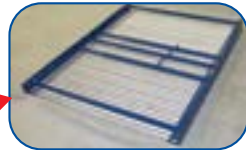

WOOL SACKER



1037 **\$375**

2-WAY SHEARING GATE



999 **\$525**



Third-generation, family and veteran-owned company leading the sheep and goat industry for over 40 years



Our Sydell family is proud to find our products on family farms throughout North America.

SHEARING

ITEM	DESCRIPTION	SIZE	PRICE
1034	6' Aluminum Revolving Skirting Table	Adjustable height	\$2,080
1035	Skirting Table	4'x 6'x 3'	\$895
1036	Skirting Table	5'x 6'x 3'	\$940
1037	Wool Sacker	6'6"	\$375
999	2-Way Shearing Gate		\$525

Sydell, Inc. is proud to be a third-generation family company. Over 40 years ago, John Lynch and his parents started the company with an idea to manufacture innovative lambing pens. Today, those lambing pens remain a staple in Sydell's product line. Over the years, John's wife and two daughters have been instrumental in growing and developing Sydell into what it is today. Our family is proud to find our products on family farms throughout North America.

One of our most rewarding experiences is loading a truck with our American-made products to serve the needs of farms, fairgrounds, universities, research facilities and commercial operations. Our team of hard-working craftsmen are the heart of our company. With decades of experience, we are determined to deliver the best products to you, our customer.

Sydell's sales team has decades of experience. Our customers know Kyle, Jake and Steve by name. Their first-hand knowledge as producers and innovators for Sydell is invaluable when helping customers determine which products best serve their needs. You can count on our team to be here to help you each step of the way. Whether you are a new or experienced producer, we're here to deliver the products and service you need.

The Lynch Family
John, Doralee, Stephanie & Melissa

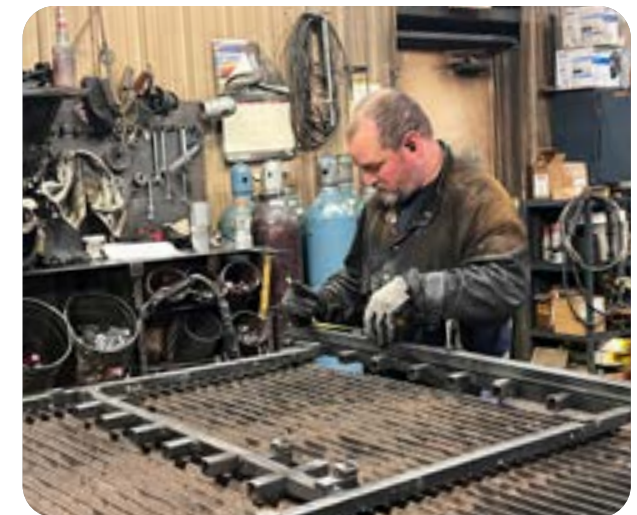

Waterers are all polyethylene with polyurethane insulation. Includes heater and heat tape.

Model 2017 has stainless steel trough with heater.



2015 **\$595**



2016 **\$595**



2017 **\$795**

WATERERS

ITEM	DESCRIPTION	SIZE	PRICE
2015	8 Gallon, 2-Sided Ritchie Waterer	33 1/2" x 14" x 22", 13" Trough Height	\$595
2016	4.2 Gallon, 2-Sided Ritchie Waterer	33 1/2" x 14" x 23 1/2", 18" Trough Height	\$595
2017	2.2 Gallon, Omni 2, 2-Sided Ritchie Waterer	28.3" x 14 1/2" x 25", 18" Trough Height	\$795



Let our team of experienced producers help find the right products to suit your needs.



46935 SD Hwy 50
Burbank, SD 57010-7109
USA



605.624.4538
800.842.1369



Follow us on Facebook
for show information, delivery
routes, discounts and specials



Sydell.COM

