

INSTALLING THE ENCLOSURE HEATER MODEL 854033

QUICK START GUIDE

P/N 6008412, REVISION B
JANUARY 2016

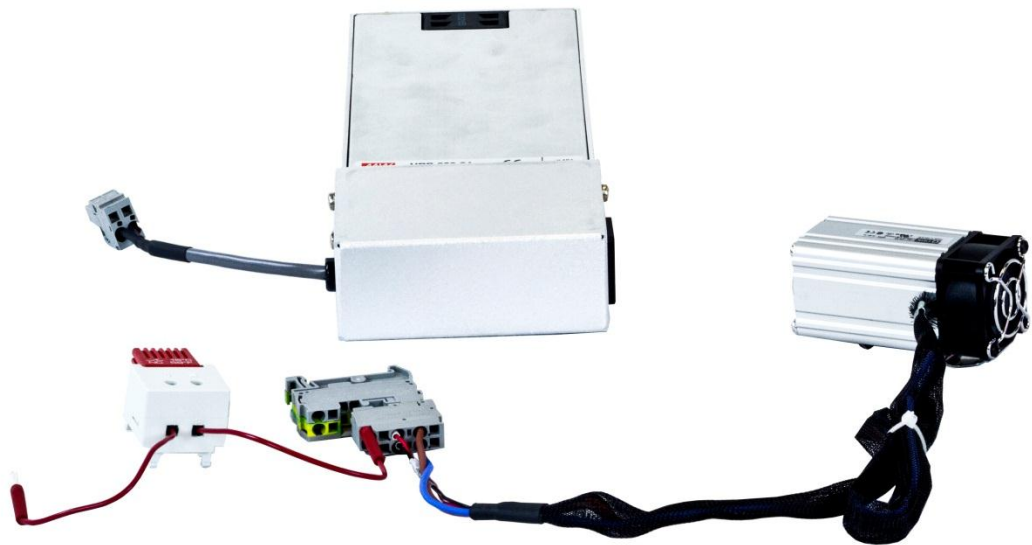





TSI and TSI logo are registered trademarks of TSI Incorporated.





This guide will help you quickly install the Enclosure Heater (854033) for the Environmental Enclosure (854030).

Unpacking

1. Unpack the enclosure heater and verify that all the items listed in the following table are present.
2. Contact [TSI](#) immediately if items are missing or broken.

Qty.	Item Description	Reference Picture
1	Power Supply, 300 watts	
1	Thermostat	
1	Power Connector www.phoenixcontact.com Feed-through terminal block. Gray. Small, P/N 3040012.	
1	Ground Connector www.phoenixcontact.com Spring cage ground terminal block. Green Small P/N 3040025	

Qty.	Item Description	Reference Picture
1	Heater	
2	Vent Plugs	

Warning Labels



Warns that the instrument could be hot to the touch or a burn hazard.

Installing the Enclosure Heater (854033)

1. If Model 854034 power supply is installed, unplug the DC power cable from DIN rail, unplug the main power to the power supply, and snap the power supply clip off the upper DIN rail and go to step 3.

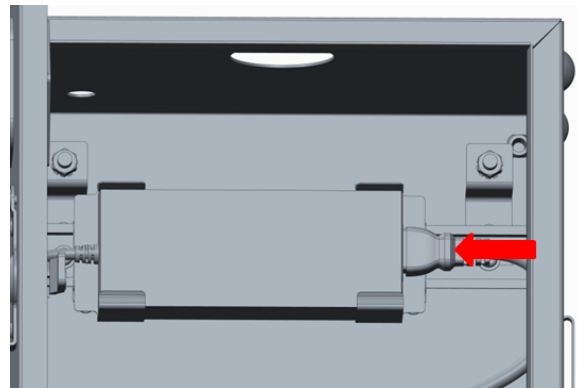

2. If not already installed, add top DIN Rail Mount: Remove nuts from welded stud and mount DIN Rail Mount to Weld Stud. Install the upper DIN Rail onto the mounting brackets using the provided #10 hardware. Mount the DIN Rail w/Mounting Brackets to the Enclosure Weld Studs using the Kep Nuts provided with the enclosure.

3. Mount the Heater Power Supply onto the upper DIN Rail by hanging the top bracket clips on the DIN Rail and snapping the bottom back into place. Attach the Mains Power Cord, looping the cord as shown.

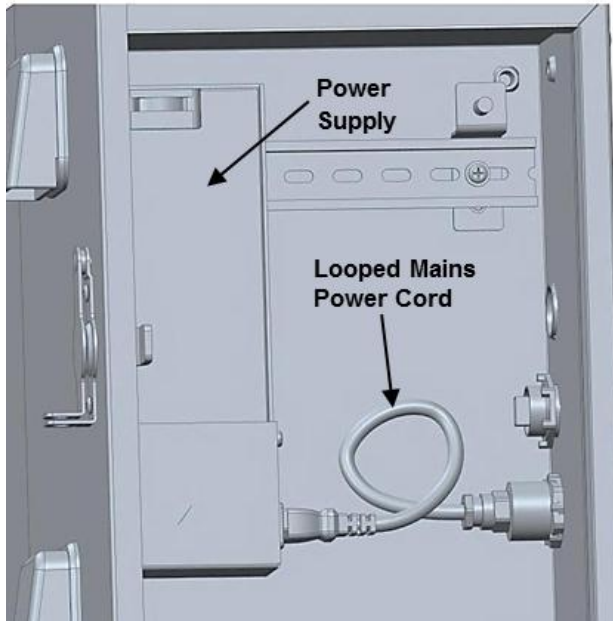

4. Install the thermostat onto the lower DIN Rail and plug thermostat wire into the "+" (Gray) DIN Rail Power Connector.

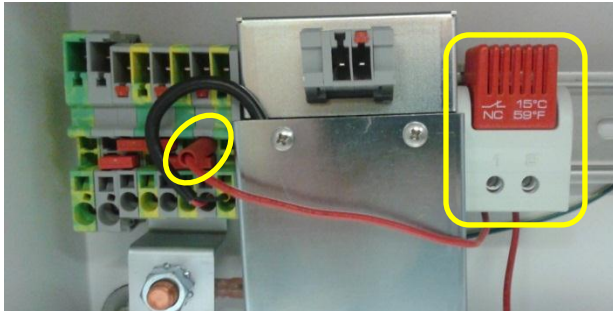

5. Install the Gray Power Connector and Green Ground Connector onto the DIN Rail next to the Thermostat. Ensure Power Connector (Gray) is to the left of the Ground Connector and next to the Thermostat.



6. Install the Heater onto the DIN Rail and Plug into the two Phoenix Connectors just installed to the right of the Thermostat.

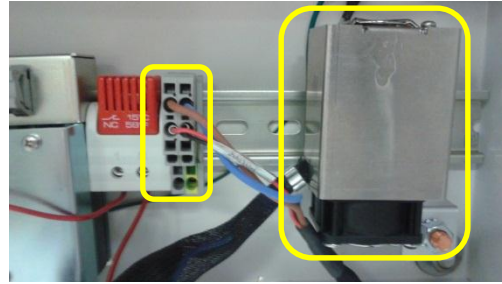

7. Plug the remaining Thermostat wire into the "+" side of the Heater Connector (left side of connector, Gray) as shown.



DO NOT PLUG THE THERMOSTAT WIRES INTO THE GREEN/YELLOW PHOENIX GROUND CONTACTS

THE THERMOSTAT **MUST** PROVIDE POWER TO THE HEATER. BYPASSING THE THERMOSTAT, OR PLUGGING THE HEATER DIRECTLY INTO THE POWER SIDE OF THE DIN RAIL, WILL CAUSE THE HEATER TO RUN CONSTANTLY AND MAY DAMAGE EQUIPMENT AND LEAD TO PREMATURE FAILURE(S).

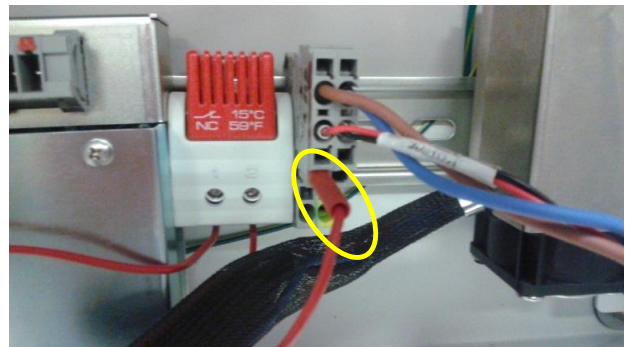

8. Insert vent plugs into openings to help keep heat inside enclosure in cold environments. Twist covers counter clockwise to remove. Hand-tighten after inserting plug.

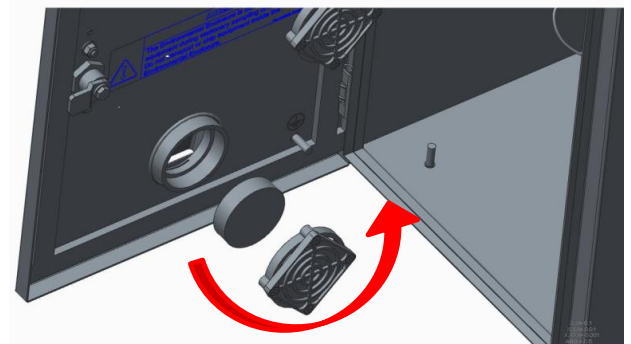

- Remove vent plugs when weather conditions do not require use of the heater. Twist vent cover counter clockwise to remove vent plugs. Hand-tighten after removing plug.

Operating Instructions

- The heater thermostat is preset, no adjustment or setting is required. Thermostat will turn heater on automatically when the temperature inside the enclosure reaches approximately +5°C (41°F).
- The thermostat will automatically turn off the heater when the temperature in the enclosure is approximately +15°C (59°F).

Specifications

Nominal Heater Power	24 Volts DC; 100 Watts
Temp Range	Will keep instruments inside enclosure above 0°C (32°F) with outside temperature down to -20°C (-4°F).



UNDERSTANDING, ACCELERATED

TSI Incorporated – Visit our website www.tsi.com for more information.

USA	Tel: +1 800 874 2811	India	Tel: +91 80 67877200
UK	Tel: +44 149 4 459200	China	Tel: +86 10 8219 7688
France	Tel: +33 1 41 19 21 99	Singapore	Tel: +65 6595 6388
Germany	Tel: +49 241 523030		