



AEROTRAK® HANDHELD AIRBORNE PARTICLE COUNTER MODEL 9306

OPERATION MANUAL

P/N 6004215, REVISION L
DECEMBER 2019



START SEEING THE BENEFITS OF REGISTERING TODAY!

Thank you for your TSI instrument purchase. Occasionally, TSI releases information on software updates, product enhancements and new products. By registering your instrument, TSI will be able to send this important information to you.

<http://register.tsi.com>

As part of the registration process, you will be asked for your comments on TSI products and services. TSI's customer feedback program gives customers like you a way to tell us how we are doing.



UNDERSTANDING, ACCELERATED

TSI Incorporated - Visit our website **www.tsi.com** for more information.

USA	Tel: +1 800 874 2811	India	Tel: +91 80 67877200
UK	Tel: +44 149 4 459200	China	Tel: +86 10 8219 7688
France	Tel: +33 1 41 19 21 99	Singapore	Tel: +65 6595 6388
Germany	Tel: +49 241 523030		

AEROTRAK®
HANDHELD AIRBORNE
PARTICLE COUNTER
MODEL 9306

OPERATION MANUAL

P/N 6004215, REVISION L
DECEMBER 2019

SHIP TO/MAIL TO:

TSI Incorporated
500 Cardigan Road
Shoreview, MN 55126-3996
USA

U.S.

Technical Support:

(800) 680-1220/(651) 490-2860

Fax:

(651) 490-3824

E-mail address:

answers@tsi.com

Website:

<http://www.tsi.com>

INTERNATIONAL

Technical Support:

(001 651) 490-2860

Fax:

(001 651) 490-3824

Manual History

The following is a manual history of the AeroTrak® Handheld Airborne Particle Counter, Model 9306 Operation Manual (P/N 6004215).

Revision	Date
A	July 2010
B	September 2010
C	February 2011
D	March 2012
E	November 2012
F	October 2013

Revision	Date
G	January 2014
H	February 2016
J	August 2016
K	March 2018
L	December 2019

Warranty

Part Number	6004215 / Revision L / December 2019
Copyright	©TSI Incorporated / 2010-2019 / All rights reserved.
Address	TSI Incorporated / 500 Cardigan Road / Shoreview, MN 55126 / USA
E-mail Address	answers@tsi.com
Limitation of Warranty and Liability (effective April 2014)	<p>(For country-specific terms and conditions outside of the USA, please visit www.tsi.com.)</p> <p>Seller warrants the goods, excluding software, sold hereunder, under normal use and service as described in the operator's manual, to be free from defects in workmanship and material for 24 months, or if less, the length of time specified in the operator's manual, from the date of shipment to the customer. This warranty period is inclusive of any statutory warranty. This limited warranty is subject to the following exclusions and exceptions:</p> <ol style="list-style-type: none">Hot-wire or hot-film sensors used with research anemometers, and certain other components when indicated in specifications, are warranted for 90 days from the date of shipment;Pumps are warranted for hours of operation as set forth in product or operator's manuals;Parts repaired or replaced as a result of repair services are warranted to be free from defects in workmanship and material, under normal use, for 90 days from the date of shipment;Seller does not provide any warranty on finished goods manufactured by others or on any fuses, batteries or other consumable materials. Only the original manufacturer's warranty applies;This warranty does not cover calibration requirements, and seller warrants only that the instrument or product is properly calibrated at the time of its manufacture. Instruments returned for calibration are not covered by this warranty;This warranty is VOID if the instrument is opened by anyone other than a factory authorized service center with the one exception where requirements set forth in the manual allow an operator to replace consumables or perform recommended cleaning;This warranty is VOID if the product has been misused, neglected, subjected to accidental or intentional damage, or is not properly installed, maintained, or cleaned according to the requirements of the manual. Unless specifically authorized in a separate writing by Seller, Seller makes no warranty with respect to, and shall have no liability in connection with, goods which are incorporated into other products or equipment, or which are modified by any person other than Seller. <p>The foregoing is IN LIEU OF all other warranties and is subject to the LIMITATIONS stated herein. NO OTHER EXPRESS OR IMPLIED WARRANTY OF FITNESS FOR PARTICULAR PURPOSE OR MERCHANTABILITY IS MADE. WITH RESPECT TO SELLER'S BREACH OF THE IMPLIED WARRANTY AGAINST INFRINGEMENT, SAID WARRANTY IS LIMITED TO CLAIMS OF DIRECT INFRINGEMENT AND EXCLUDES CLAIMS OF CONTRIBUTORY OR INDUCED INFRINGEMENTS. BUYER'S EXCLUSIVE REMEDY SHALL BE THE RETURN OF THE PURCHASE PRICE DISCOUNTED FOR REASONABLE WEAR AND TEAR OR AT SELLER'S OPTION REPLACEMENT OF THE GOODS WITH NON-INFRINGING GOODS.</p> <p>TO THE EXTENT PERMITTED BY LAW, THE EXCLUSIVE REMEDY OF THE USER OR BUYER, AND THE LIMIT OF SELLER'S LIABILITY FOR ANY AND ALL LOSSES, INJURIES, OR DAMAGES CONCERNING THE GOODS (INCLUDING CLAIMS BASED ON CONTRACT, NEGLIGENCE, TORT, STRICT LIABILITY OR OTHERWISE) SHALL BE THE RETURN OF GOODS TO SELLER AND THE REFUND OF THE PURCHASE PRICE, OR, AT THE OPTION OF SELLER, THE REPAIR OR REPLACEMENT OF THE GOODS. IN THE CASE OF SOFTWARE, SELLER WILL REPAIR OR REPLACE DEFECTIVE SOFTWARE OR IF UNABLE TO DO SO, WILL REFUND THE PURCHASE PRICE OF THE SOFTWARE. IN NO EVENT SHALL SELLER BE LIABLE FOR LOST PROFITS, BUSINESS INTERRUPTION, OR ANY SPECIAL, INDIRECT, CONSEQUENTIAL OR INCIDENTAL DAMAGES. SELLER SHALL NOT BE RESPONSIBLE FOR INSTALLATION, DISMANTLING OR REINSTALLATION COSTS OR CHARGES. No Action, regardless of form, may be brought against Seller more than 12 months after a cause of action has accrued. The goods returned under warranty to Seller's factory shall be at Buyer's risk of loss, and will be returned, if at all, at Seller's risk of loss.</p>

Buyer and all users are deemed to have accepted this LIMITATION OF WARRANTY AND LIABILITY, which contains the complete and exclusive limited warranty of Seller. This LIMITATION OF WARRANTY AND LIABILITY may not be amended, modified or its terms waived, except by writing signed by an Officer of Seller.

Service Policy

Knowing that inoperative or defective instruments are as detrimental to TSI as they are to our customers, our service policy is designed to give prompt attention to any problems. If any malfunction is discovered, please contact your nearest sales office or representative, or call TSI's Customer Service department at 1-800-680-1220 (USA) or +001 (651) 490-2860 (International).

Trademarks

AeroTrak and TRAKPRO are trademarks of TSI Incorporated. TSI and the TSI logo are registered trademarks of TSI Incorporated. Microsoft and Excel are registered trademarks of Microsoft Corporation. OpenOffice is a trademark of Sun Microsystems. Modbus® is a registered trademark of Modicon, Inc.

Contents

Manual History	ii
Warranty	iii
Safety Information	vii
Laser Safety	vii
Labels	viii
Description of Caution/Warning Symbols	ix
Caution	ix
Warning	ix
Caution or Warning Symbols	ix
Getting Help	x
CHAPTER 1 Introduction and Unpacking	1-1
Unpacking the AeroTrak [®] Handheld Airborne Particle Counter	1-2
Optional Accessories	1-4
CHAPTER 2 Getting Started	2-1
Instrument Description	2-1
Using the Instrument Stand and Stylus	2-2
Providing Power	2-3
To Install the Lithium-Ion Battery	2-3
To Use AC Power	2-4
Using with a Printer	2-4
Installing an Isokinetic Inlet	2-5
Installing a Temperature/Relative Humidity Probe	2-5
CHAPTER 3 Operation	3-1
Screen Layout and Functionality	3-2
Software Input Panel (Keyboard or Keypad)	3-2
Main Tab	3-3
Zoomed Data Screen	3-7
Setup Tab	3-8
Zone Setup Screen	3-9
Recipes Setup Screen	3-14
System Setup Screen	3-19
Change Power On Password Screen	3-19
Change Setup Password Screen	3-21
Configuration Screen	3-22
Print Setup Screen	3-23
Print Schedule Screen	3-24
Clear Samples Screen	3-25
Information Screen	3-25
Device Setup Screen	3-26
Date and Time Screen	3-26
Display Screen	3-27
Communications Screen	3-28

Regional Screen	3-29
Environment Screen	3-30
Data Tab	3-30
Export Data Screen	3-32
Print Data.....	3-35
Reports Tab	3-37
Exclude Samples Form	3-40
Data Integrity Mode	3-41
CHAPTER 4 Data Handling	4-1
USB Data Download	4-1
USB Computer Communication	4-1
Installing Software.....	4-2
Ethernet Communications.....	4-2
CHAPTER 5 Maintenance	5-1
Maintenance Schedule.....	5-1
Zero Check.....	5-1
Cleaning the Instrument Enclosure.....	5-1
CHAPTER 6 Troubleshooting.....	6-1
CHAPTER 7 Contacting Customer Service.....	7-1
Technical Contacts.....	7-1
International Contacts.....	7-1
Service.....	7-1
Technical Support.....	7-2
Returning the AeroTrak® Handheld Airborne Particle Counter for Service.....	7-3
APPENDIX A Specifications	A-1
Temperature/RH Probe (700084) Specifications (optional accessory).....	A-2
Compliance	A-3
Dimensional Diagram.....	A-3

Index

Safety Information

This section gives instructions to promote safe and proper handling of the AeroTrak® Handheld Airborne Particle Counters.

IMPORTANT

There are no user-serviceable parts inside the instrument. Refer all repair and maintenance to a qualified factory-authorized technician. All maintenance and repair information in this manual is included for use by a qualified factory-authorized technician.

Laser Safety

- The Model 9306 Handheld Airborne Particle Counter is a Class I laser-based instrument.
- During normal operation, you **WILL NOT** be exposed to laser radiation.
- Precaution should be taken to avoid exposure to hazardous radiation in the form of intense, focused, visible light.
- Exposure to this light may cause blindness.

Take these precautions:

- **DO NOT** remove any parts from the particle counter unless you are specifically told to do so in this manual.
- **DO NOT** remove the housing or covers. There are no user-serviceable components inside the housing.









WARNING

The use of controls, adjustments, or procedures other than those specified in this manual may result in exposure to hazardous optical radiation.

Labels

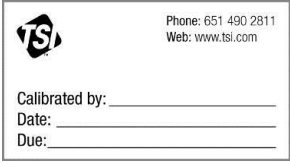
Advisory labels and identification labels are attached to the outside of the particle counter housing and to the optics housing on the inside of the instrument.

<p>1. Serial number label (back panel)</p>	 <p>AeroTrak APC 9306 – 03 Channels: 3/ 5/ 7/1/2/5um, 0.1CFM COMPLIES WITH 21 CFR 1040.10 AND 1040.11</p> <hr/> <p>Manufactured : August 2016</p>  <p>*93061107008*</p> <hr/> <p>12V  2.5A  </p> <p>TSI Incorporated www.tsi.com 500 Cardigan Road Shoreview, MN 55126, USA Made in USA</p>
<p>2. Laser radiation label (internal)</p>	<p>DANGER! VISIBLE LASER RADIATION WHEN OPEN. AVOID DIRECT EXPOSURE TO BEAM WARNING: NO USER SERVICABLE PARTS INSIDE. REFER SERVICING TO QUALIFIED PERSONNEL</p>
<p>3. Calibration Label (side panel)</p>	 <p>Phone: 651 490 2811 Web: www.tsi.com</p> <p>Calibrated by: _____ Date: _____ Due: _____</p>
<p>4. Laser radiation symbol label (internal)</p>	
<p>5. European symbol for non- disposable item. Item must be recycled.</p>	

Description of Caution/Warning Symbols

Appropriate caution/warning statements are used throughout the manual and on the instrument that require you to take cautionary measures when working with the instrument.

Caution



CAUTION

Failure to follow the procedures prescribed in this manual might result in irreparable equipment damage. Important information about the operation and maintenance of this instrument is included in this manual.

Warning



WARNING

Warning means that unsafe use of the instrument could result in serious injury to you or cause damage to the instrument. Follow the procedures prescribed.

Caution or Warning Symbols

The following symbols may accompany cautions and warnings to indicate the nature and consequences of hazards:

	Warns that uninsulated voltage within the instrument may have sufficient magnitude to cause electric shock. Therefore, it is dangerous to make contact with any part inside the instrument.
	Warns that the instrument contains a laser and that important information about its safe operation and maintenance is included in the manual.
	Warns that the instrument is susceptible to electro-static dissipation (ESD) and ESD protection procedures should be followed to avoid damage.
	Indicates the connector is connected to earth ground and cabinet ground.

Getting Help

To obtain assistance with this product or to submit suggestions, please contact Customer Service:

TSI Incorporated
500 Cardigan Road
Shoreview, MN 55126 U.S.A.

Fax: (651) 490-3824 (USA)

Fax: 001 651 490 3824 (International)

Telephone: 1-800-680-1220 (USA) or (651) 490-2860

International: 001 651 490 2811

E-mail Address: technical.services@tsi.com

Web site: www.tsi.com

CHAPTER 1

Introduction and Unpacking

The AeroTrak® Model 9306 Airborne Particle Counter (particle counter) is a lightweight, handheld particle counter with a touch-screen interface. It operates on the included lithium-ion battery or AC power.

This device has a 0.1 CFM (2.83 L/min) flow rate and counts bin sizes from 0.3 to 25 µm that depend on the model ordered (see table below). Up to 10,000 data sets can be downloaded for analysis and reporting using the TrakPro™ Lite Secure Data Download Software included with the device.

Model	Size Range
9306-03	0.3, 0.5, 0.7, 1.0, 2.0, 5.0 µm
9306-04	0.3, 0.5, 1.0, 3.0, 5.0, 10.0 µm
9306-V2	0.3 to 10 µm, user-selectable; factory-calibrated at 0.3, 0.5, 1.0, 3.0, 5.0, 10.0 µm







Typical applications for this particle counter include clean room monitoring, research, exposure assessment, indoor air quality, filter testing, clearance testing, quality assurance, and contaminant migration studies. All AeroTrak® particle counters meet JIS standards.



(continued on next page)

Unpacking the AeroTrak® Handheld Airborne Particle Counter

Carefully unpack the AeroTrak® Airborne Particle Counter from the shipping container and verify that all the items shown in the photos below and listed in the following tables are present. Contact [TSI](#) immediately if items are missing or broken.

Model 9306 AeroTrak® Airborne Particle Counter Parts List





Qty.	Item Description	Part/Model	Reference Picture
1	AeroTrak® Airborne Particle Counter	9306-03 9306-04 9306-V2	
1	Power Supply with universal plugs	801694	
1	Isokinetic inlet	700003 AL	
1	Battery pack	700032	
1	Computer cable (2 m), USB A to B	700033	
1	Stylus	N/A	
1	HEPA zero filter assembly	700005	

Qty.	Item Description	Part/Model	Reference Picture
1	TrakPro™ Lite Secure Software CD for 21 CFR Part 11 compliant data downloading <i>(includes manuals)</i>	7001901	
1	Operation Manual	6004215	<i>Included on TrakPro™ Lite Secure Software CD</i>
1	Quick Start Guide	6004216	
1	Calibration certificate	N/A	

Optional Accessories

The following photos and table list optional accessories. If you ordered optional accessories, make certain they have been received and are in working order.

Model 9306 AeroTrak® Airborne Particle Counter Optional Accessories

Item Description	Part/Model	Reference Picture
External battery charger with AC adapter and power cord	700025	
External Printer	700085	
Carry case	700083	
Temperature/humidity probe	700084	
Stainless Steel Isokinetic inlet	700004	
Isokinetic probe (used with tubing)	700001 AL 700002 SS	
0.1 cfm Barb Inlet Fitting	700020	
Tubing, Superthane 1/8-inch ID x 1/4-inch OD, Clear 100 ft.	700009	

CHAPTER 2

Getting Started

This chapter provides information to help you use the Model 9306 AeroTrak® Handheld Airborne Particle Counter including:

- [Instrument Description](#)
- [Using the Instrument Stand and Stylus](#)
- [Providing Power](#)
- [Installing an Isokinetic Inlet](#)
- [Installing a Temperature/Relative Humidity Probe](#)

Instrument Description

The Model 9306 has many features to make measurements convenient. They are described in detail below.



Using the Instrument Stand and Stylus

The Model 9306 is equipped with an integral instrument support stand. To open the stand, grasp it by the large finger hole and pull it out until it locks into place. Be careful not to overextend the stand. To store the stand out of the way when not in use, simply push the stand back until it snaps into place.



The Model 9306 is also equipped with a plastic stylus for use with the touch screen interface. The stylus locks into place in the case near the top of the unit when not in use.



Providing Power

The Model 9306 may be powered using a rechargeable lithium-ion battery, or through an AC power cord.

NOTES

- When using AC power, the battery (if installed) charges when the instrument is on, but not while actively sampling.
- When charging in “**Standby Mode**,” the instrument will shut down once fully charged.
- Removing/changing the lithium-ion battery or disconnecting AC power does not cause loss of data.

To Install the Lithium-Ion Battery

1. Remove the battery cover from the back of the instrument by lightly depressing the textured tab on the cover located on the lower left.

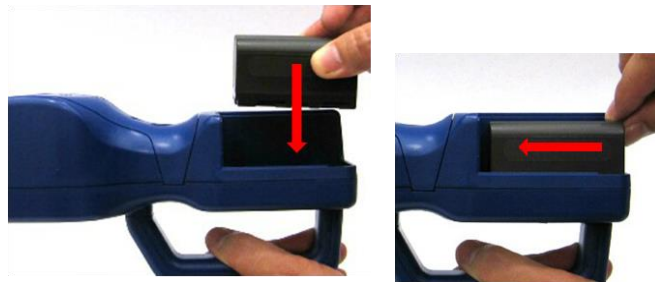

2. Place the lithium-ion battery into the battery compartment and slide it forward (toward the top of the unit) until it locks into place.
3. Replace the battery cover and slide it in place until you hear a click.



WARNINGS

The battery supplied by TSI (P/N 700032) has built in protection against explosion and fire hazard. **DO NOT** use a substitute.

DO NOT use non-rechargeable batteries in this instrument. Fire, explosions, injury or other hazards may result.

To Use AC Power

1. Connect the AC power adapter to the power cord.
2. Insert the AC power adapter into the side of the Model 9306.
3. Connect the power cord to an outlet.
4. Press the **on/off** button  (located on the front of the instrument handle).
5. After a splash screen displays the TSI logo, a brief start-up sequence begins as the Windows® CE operating system boots up.

Using with a Printer

A hard copy of a sample set can be printed from the instrument using the optional TSI Model 700085 thermal printer (see Chapter 3, [“Operation”](#)). Only the TSI Model 700085 printer is compatible with the Model 9306. The printer may be used on its internal battery or an AC adapter. A custom communications cable is included with the printer. The cable goes between the USB A port and the 9-pin DSUB on the printer.



Installing an Isokinetic Inlet

The Isokinetic inlet smoothly accelerates air into the inlet of the instrument. To install, simply thread the inlet directly onto the inlet nozzle until finger tight. The inlet seals over an O-ring so it does not have to be very tight to seal.



Installing a Temperature/Relative Humidity Probe

To install the optional temperature/relative humidity probe:

1. Align the probe so the pins slide into the sockets of the base connector.
2. Align the locking collar on the probe so it will slide over the alignment pins on the base connector.
3. Press down and turn the locking collar to lock in the probe.
4. Temperature and relative humidity are automatically displayed in the upper-left corner.
5. Remove the probe by turning the locking collar and then pulling straight up on the probe.



(This page intentionally left blank)

CHAPTER 3

Operation

The Model 9306 AeroTrak® Handheld Airborne Particle Counter is controlled using a touch screen display.

NOTE

Use the plastic stylus or your finger tip. **DO NOT** use sharp objects (such as a pen point) that may damage the screen overlay.

To turn on the instrument, press the **on/off** button (located in the center of the front of the instrument). After a splash screen displays the TSI logo, a brief start-up sequence begins as the Windows® CE operating system boots up.

The instrument is ready for operation when the **Main** tab (shown below) appears. If an optional temperature/humidity probe is attached, those values will be shown in the upper-left corner also.

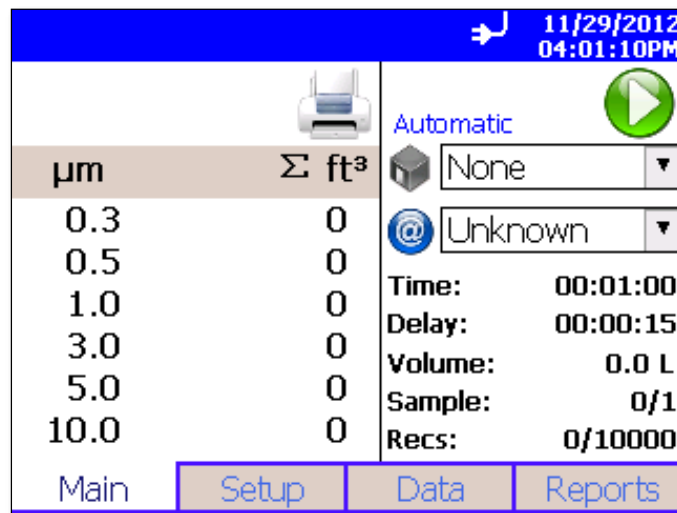

Screen Layout and Functionality

There are four main screens (tabs):

- [Main](#) tab
- [Setup](#) tab
- [Data](#) tab
- [Reports](#) tab

The operation of each of these screens, the information displayed on them, and the operations you can perform from each are described in the remainder of this chapter.

Some screens require or allow you to enter information. To enter information, tap on the screen and an on-screen keyboard appears.

Software Input Panel (Keyboard or Keypad)

1. Throughout the setup screens, a keyboard or keypad appears on the screen when text or numbers may be entered.
2. When you enter information using the keyboard, press either the ↵ (**Enter**) or **Esc** keys when you are done. When you enter data using the keypad, the data is entered when you press **OK** on the screen. The keyboard will then be hidden until another text entry box is selected.



3. When numeric input is required, a numeric keypad will appear on the screen in place of the full keyboard.









Main Tab

The **Main** tab is the default screen. The left side of the screen summarizes the concentrations for the currently selected location. Tap on the size and count portion of the screen to enable Zoomed Data Screen (see [Setup Tab](#)).

The display shows:

- Temperature*
- Relative humidity*
- Bin sizes
- Particle count/concentration

The status bar at the top of the screen shows the current time and date (see the [Setup Tab](#)) and indicates:

Icon	Description
	Instrument status error. If this icon is shown, it can be pressed and a more detailed description of the operational error will be shown. Refer to the troubleshooting section for appropriate actions. If an instrument error occurs, an audible alarm will also sound.
	Sufficient flow through the instrument. NOTE During Start Delay (Delay) and Hold Times (Hold), this is only an indicator of flow On. During Sample Time (Time), this is an indicator of flow within specified tolerances.
	Insufficient flow through the instrument. If this icon is shown, it can be pressed and a more detailed description of the flow error will be shown. Refer to the trouble shooting section for appropriate actions. If a flow error occurs, an audible alarm will also sound. NOTE During Start Delay (Delay) and Hold Times (Hold), this is an indicator of flow Off. During Sample Time (Time), this is an indicator of flow not being within specified tolerances.
	Operating on AC power, no battery installed
	Operating on AC power, battery is installed and charging. (The battery charges when the instrument is on but not actively taking a particle sample.)
	Battery charged
	Low battery
	Battery is very low!

*Temperature and Humidity are displayed only if the optional T/H probe is installed.





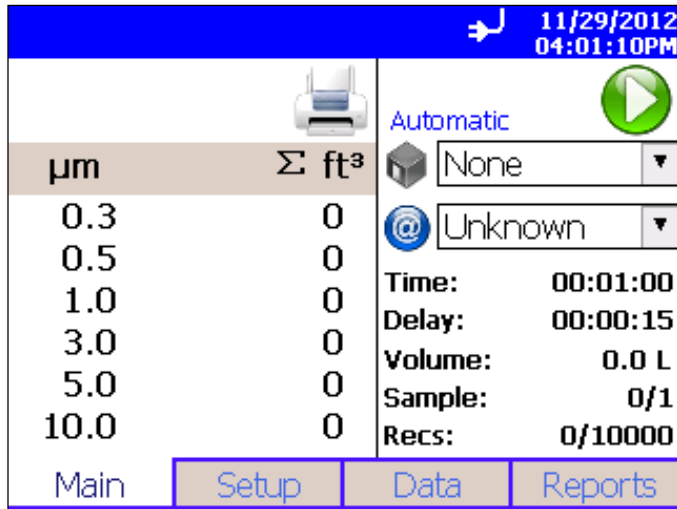

Indicates that TrakPro Lite Secure software is interfacing with the AeroTrak® particle counter. The front panel GUI is inoperable when the software is operational. Once the software is exited, normal front panel operation will resume.

Press and hold the  (Zone) icon to display a summary of information for the current Zone.

Tap the  (Location) icon to step through the list of Locations for the Zone.



μm	$\Sigma \text{ ft}^3$	Mode	Zone	Location
0.3	0	Automatic	None	Unknown
0.5	0			
1.0	0			
3.0	0			
5.0	0			
10.0	0			
Main		Time: 00:01:00	Delay: 00:00:15	Volume: 0.0 L
Setup		Sample: 0/1	Recs: 0/10000	
Data				
Reports				

Field	Description
 (Zone)	Displays the Zone where the sample is being taken by the instrument. Press the icon to display a summary of information for the Zone.
 (Location)	This drop-down box allows selection of a preconfigured Location to associate the sampled data to.
Time	The time for each sample.
Delay	The Delay displays one of two times: <ol style="list-style-type: none"> 1. Before the Start button is pressed the Start Delay time is displayed and then immediately after the Start button is pressed the Delay time begins a countdown. 2. During sampling and between cycles (after the Start Delay has been displayed), the Hold Delay is displayed and then begins a countdown.
Recs	The total number of records in the database/10000 (maximum number of records).
Manual/Automatic/Beep	Mode Indicator; refers to the “ Data Count Mode ” (see section below).
	Start/Stop button to begin and end sampling in the configured mode. Start/Stop may also be entered using the triangle-shaped button above the power button on the front of the instrument.
	Press to print the current sample to the optional printer.

A USB 1D barcode scanner can be used (Zebra LS2208 works well) to select an existing Zone and Location pair in the list boxes on the Main page, if the barcodes use the format ZoneName:LocationName (i.e., the zone name followed by a colon followed by the location name). The barcode can then be scanned and the specified zone and location will be automatically selected in the list boxes.

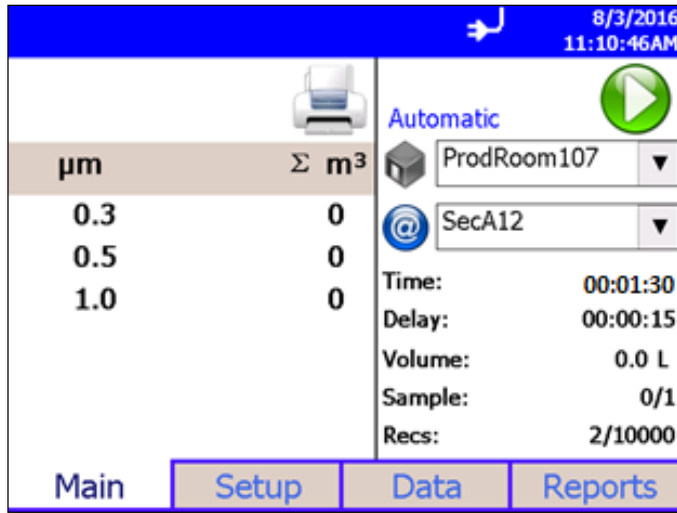

There are free online barcode generators available (i.e., <http://barcode.tec-it.com/en>). Select linear Code 128 to generate the barcodes.

Zoomed Data Screen

The **Zoomed Data** screen is entered by touching in the size and count part of the main tab display. The bottom portion of the screen summarizes the concentrations for the currently selected location. Tap the size and count portion of the display to switch back to the **Main** tab display.

The display shows:

- Temperature*
- Relative humidity*
- Bin sizes
- Particle count/concentration

The screenshot shows a mobile application interface for 'Sampling'. At the top, it displays the date '5/3/2010' and time '1:20:43 PM'. Below this, environmental data is shown: '28.0' (likely temperature) and '50 %RH' (relative humidity). The location is identified as 'Loc001' and the mode is 'Automatic'. A green square icon is visible in the top right corner. The main part of the screen is a table with particle size bins in micrometers (µm) and their corresponding counts (Σ).

µm	Σ
0.3	362
0.5	177
1.0	73
3.0	24
5.0	7
10.0	4

Field	Description
Location	Label that displays information about the currently selected location.
Manual/Automatic/Beep	Mode Indicator; refers to the "Data Count Mode" (see section below).
	Press the Start/Stop button to begin sampling in the configured mode.

*Temperature and Humidity are displayed only if the optional T/H probe is installed.

Setup Tab

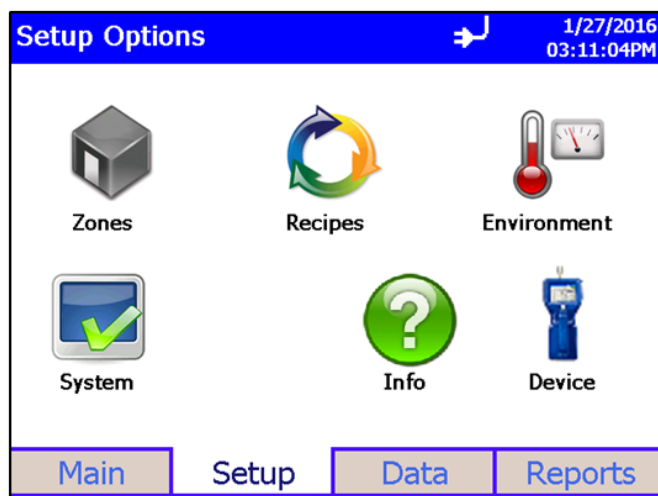

The **Setup** tab provides access to the following:

Zones Setup	Identify and save the location information associated with collected samples.
Recipes Setup	Save a group of settings (a Recipe) that you use over and over so you do not have to reset individual settings.
Environment Setup	Sets which units are preferred for displaying environmental measurements taken using optional measurement probes.
System Setup	Change Power On Password, Setup Password, System Configuration, Print Settings, Print Schedule and Clear Samples
Information	View instrument information such as firmware version, model, serial number, last calibration date, USB IP Address, etc.
Device Setup	Set Date and Time, Screen Alignment, Communications, Regional Settings, and get device information.

Zone Setup Screen

"Zones" are a convenient way to group sample data for printing and export, and are required for creating standards-based classification reports. A Zone contains 1 or more "Locations"; this is modeled after cleanroom standards that prescribe the classification of a zone (or room) by taking samples at various locations within the zone.

Use the Zone Setup screen to add, delete or edit Zone configurations.

The screenshot shows a software window titled "Zones" with a blue header bar. In the top right corner of the header, there is a cursor icon and the date/time "11/29/2012 06:30:12PM". The main area is split into two panes. The left pane has a list box containing "Zone 1". The right pane displays the configuration details for the selected zone: Name: Zone 1, Standard: ISO 14644-1, Class: 7, Status: At Rest, Air Flow: Unidirectional, Area: 9 m², Locations: 3, and Recipe: Z1 Recipe. Below the panes, it shows "1/250 Zones, 3/999 Locations". At the bottom, there are four buttons: "Delete", "Add", "Edit", and "Close".

The Zone configuration screen provides the following information for each zone that is configured.

Field	Description
Name	The name to assign to the Zone.
Standard	The classification standard to use for the samples taken in the Zone. Options include ISO 14644-1, EU-GMP, Fed Std 209E F, Fed Std 209E, and None. Use "None" for taking measurements that are not associated with standards classification.
Class	The Class selected for the classification of the Zone. Options vary by the Standard selected.
Status	The occupancy status of the Zone. Options vary based on the selected standard, but include <i>At Rest</i> , <i>Operational</i> and <i>As Built</i> .
Air Flow	The direction of air flow through the Zone. Options are Unidirectional or Multidirectional.
Area	The area of the Zone in ft ² or m ² .
Largest Particle Size to Consider	The largest particle size to consider for classification measurements. Used by most standards to calculate minimum required sample volume.
Locations	The Locations defined within the Zone.
Recipe	The Recipe assigned to the Zone.

To Delete A Zone

To delete a zone from the configuration screen, select (highlight) the zone name and press **Delete**. A verification message "Are you sure you want to delete this Zone?" appears. Press **Yes** to delete the zone.

A zone that has data associated with it cannot be deleted. The data associated with the zone must be deleted from the instrument before the zone can be deleted.

To Add a Zone

To add a zone, press **Add**. The **Definition** screen is displayed.

1. Enter a name for the zone and select the **Standard**, **Class**, **Status**, **Airflow** and **Largest Particle Size to Consider** options from the drop-down boxes. Input the **Area** using the keypad and select either **ft²** or **m²** to describe the area of the zone.

Zone Name	Area
z1	9.0
Standard: ISO 14644-1	
Class: 7	<input type="radio"/> ft ² <input checked="" type="radio"/> m ²
Status: At Rest	3/3 required Locations defined
Air Flow: Unidirectional	
Largest Particle Size to Consider: 5.0	

2. Press the **Locations** tab. The **Locations** screen is displayed.

Location List	Edit Name
Location01	Location03
Location02	<input type="button" value="Add"/> <input type="button" value="Auto"/>
Location03 (highlighted)	<input type="button" value="Rename"/> <input type="button" value="Move Up"/>
	<input type="button" value="Remove"/> <input type="button" value="Move Down"/>

3. Enter names for each location in the zone and then press **Add** after entering each. The name will be added to the box on the left-side of the screen.
4. Press the **Recipe** tab. The Recipe screen is displayed with a default recipe in the “**Selected Recipe**” field.
5. Select the recipe you want to use from the “**Selected Recipe**” field or press **Create Recipe** to create a new recipe or **Edit Recipe** to edit the recipe shown in the “**Selected Recipe**” field.

See [Recipes Setup Screen](#) in the **Setup** section for information about the fields and parameters of the recipe tabs (**Recipe**, **Timing**, **Channels T** and **Channels V**).

Notes

- You can also create recipes from the **Setup** tab by selecting the **Recipe** icon , but if you create a new recipe here, information you have already entered for the zone is prepopulated into the required fields.
- If you edit an existing recipe, your changes will affect all zones using that recipe. Be certain that is what you want to do.

6. When you are done selecting the recipe to use or adding a new recipe or editing an existing recipe, press **Save** or **Save New Zone**.

To Edit A Zone

1. To edit an existing zone configuration, press **Edit**. The following screen is displayed.

2. The display has three tabs:
 - Definition
 - Locations
 - Recipe

Select the tab for the information you want to edit.

3. The **Definition** screen for each zone provides the same information as displayed on the main Zone Configuration screen with the addition of “**Largest Particle Size to Consider**” field.
4. The **Locations** screen displays the locations within the selected zone. You can add, rename, or remove a location from the zone. You can also move the location name up or down in the list. The Auto feature will generate the number of locations required by the chosen standard. This utilizes the room area entered in the zone definition. The locations can then be renamed or the default naming convention can be maintained.
5. You can take as many samples as possible (up to 10,000) under a specific location attached to a specific recipe and then be able to select the samples based on date to print a report or export data for a selected number of samples.

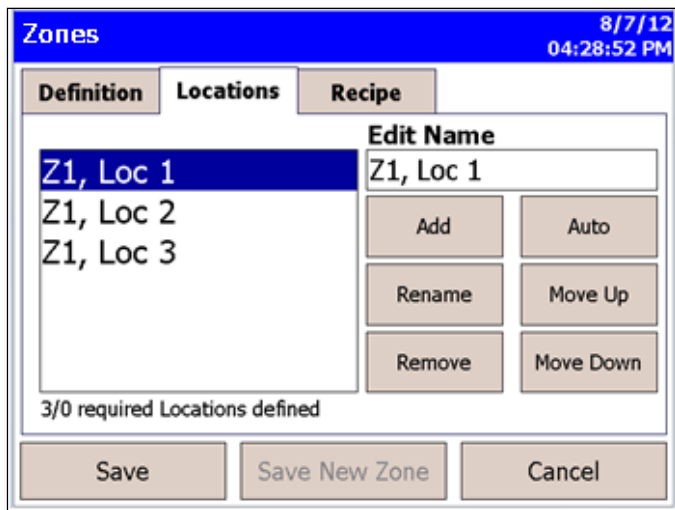

6. The **Recipe** screen displays the recipe in use for the selected zone and information relevant to that recipe. You can select a different recipe for the zone or you can create a new recipe or edit an existing recipe. (For information about recipes see the [Recipes](#) section in **Setup**.)

The screenshot shows a software window titled "Zones" with a blue header bar. The date and time "8/7/12 05:56:59 PM" are displayed in the top right corner. Below the header, there are three tabs: "Definition", "Locations", and "Recipe", with "Recipe" being the active tab. The main content area displays the following information:
"First Zone", Area 0.00 ft²
ISO 14644-1, Class 2, As Built, Unidirectional
Min. required sample time is 02:56:41 (5000.14 L)
Selected Recipe:
"Recipe 1" sample time is insufficient at 00:01:00 (28.30 liters)
At the bottom of the window, there are three buttons: "Create Recipe", "Edit Recipe", and "Save". Below these, there are three more buttons: "Save", "Save New Zone", and "Cancel".

Note

If you edit a recipe, the changes will affect all zones using that recipe. Be certain that is what you want to do.

7. When you have made all the changes, press **Save**.

Recipes Setup Screen

Use the **Recipes** setup screen to review recipes, add or delete recipes, and edit recipes. You cannot delete the “**Default**” recipe. A recipe that has samples cannot be deleted.

NOTE

The **Delete** button will be grayed out and unavailable if the recipe has samples.

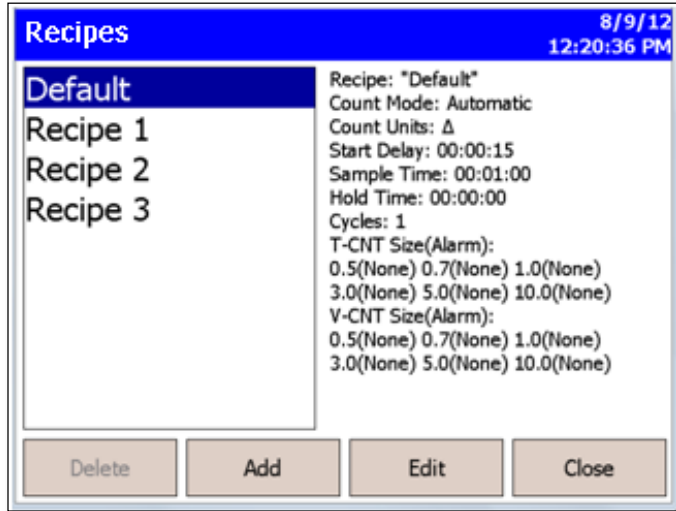

The steps for adding or editing a recipe are identical. Press either the **Add** button or the **Edit** button and proceed as follows:

1. Press **Add** or **Edit** button to display the **Recipe** tab.

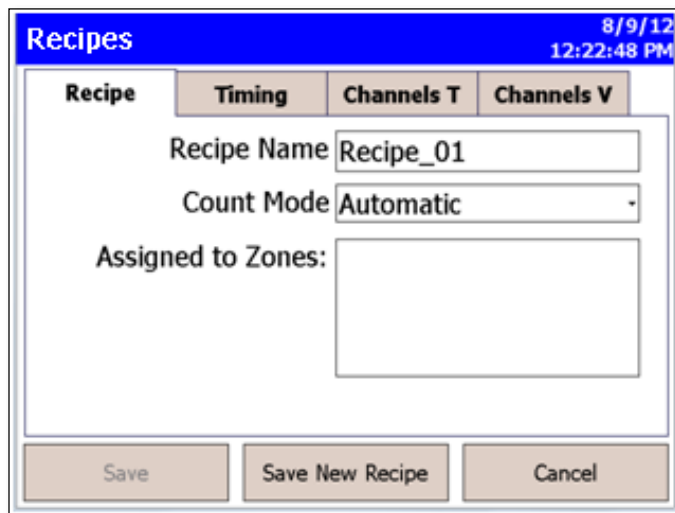

2. On the **Recipe** tab, enter a name or edit the name of the recipe. For a new recipe, a default name will appear, but you can type over it and name the recipe anything you want.

3. Select the **Count Mode**: options are **Automatic**, **Manual**, and **Beep** as described below.

Field	Description
Automatic	If this mode is selected, the particle counter starts counting in automatic mode when the start button is pressed according to the settings on the Recipes Timing Screen .
Manual	If this mode is selected, the particle counter starts sampling immediately when the start button is pressed and stops at the end of the sample time, which is configured on the Recipes Timing Screen .
Beep	<p>The Beep mode enables the AeroTrak particle counter to operate in a “Geiger Counter” mode. As particles are detected, a beep is emitted. The frequency of beeps configured utilizing the alarm thresholds setting. It works on a single bin. If you want to beep on total particulates, configure the unit in cumulative mode and set an alarm threshold for the .5 channel. The alarm threshold determines the beep frequency. The actual number of particulates measured in the preceding 1 second will be divided by the threshold and the corresponding number of beeps emitted. An alarm threshold of 0 will not emit beeps.</p> <p>To alarm on viable particulates, be sure that all total particulate alarms are disabled and configure an alarm in the viable count channels. It is configured in the same manner described above.</p> <p>If multiple alarms are configured, the AeroTrak particle counter will emit beeps only on a single channel. The AeroTrak particle counter searches for the alarm to trigger, starting with the smallest to largest channel selected.</p> <p>Settings in the sample timing screen are ignored in beep mode.</p> <p>Example: Looking for a viable particle source that raises above 500 count background by 10000. Configure the unit in cumulative mode and enable the .5 viable particulate alarm to 500. The AeroTrak particle counter will now emit a single beep for every 500 particles. At steady state, a beep will be emitted once per second ($500/500=1$). When the source is encountered it will emit 20 beeps per second ($10,000/500 = 20$). If a higher frequency is desired lower the threshold to 200. This will result in 50 beeps per second being emitted.</p> <p>The maximum number of beeps that can be emitted per second is 50.</p>

4. Finally, enter the zones that will use this recipe.

NOTE
Entering the names of the zones in this box does not assign this recipe to the zone; it is for information only. When you change the recipe for a zone, update the information here.

5. Press the **Timing** tab to enter or edit start delay times, sample time, hold time, etc.

Zones 11/29/2012 06:28:08PM

Recipe **Timing** **Channels**

Start Delay 00 : 00 : 15

Sample Time 00 : 02 : 25

Hold Time 00 : 00 : 00

Cycles 1

Volume 6.8391667

ft³ m³ liters

Save Save New Recipe Cancel

6. To make changes to the timing settings, highlight the value to change (hours, minutes, seconds, etc.) and use the on-screen keypad to change the value.



WARNING

Instrument status alarms are inactive if samples times are 10 seconds or less. Flow error alarms may not occur if sample time is less than 10 seconds. To ensure proper instrument status and flow alarm operation, use a sample time of 15 seconds or larger.

NOTE

With firmware version 2.4 and higher, you may select a date to print reports and/or export sample data. There is no need to create new zones to select data by date. There is no need to print all samples in a zone to view a specific sample or samples taken on specific dates. Samples can also be selected by date for a given recipe and zone.

Field	Description
Start Delay 	Start Delay indicates the instrument delay before starting a sample. <div style="border: 1px solid black; background-color: #f0f0f0; padding: 5px;"> <p style="text-align: center; margin: 0;">NOTE</p> <p style="margin: 0;">It takes approximately 10 seconds for the pump to reach the flow set point; taking a measurement before the pump is properly functioning may result in a data and flow error.</p> </div>
Sample Time	Sample Time indicates the instrument sample interval length.
Hold Time	Hold Time indicates the instrument delay between samples.
Cycles	Cycles is the total number of samples to collect. In Automatic mode, a cycle value of ∞ causes the instrument to continuously count using the settings for Sample Time , and Hold Time until the Start/Stop button is pressed again.
Volume	Volume sets a limit of air volume to collect for each sample. Select the volume unit then enter a volume value. The Sample Time will be updated automatically to the nearest second adequate to provide the desired volume.

7. Press the **Channels** tab.

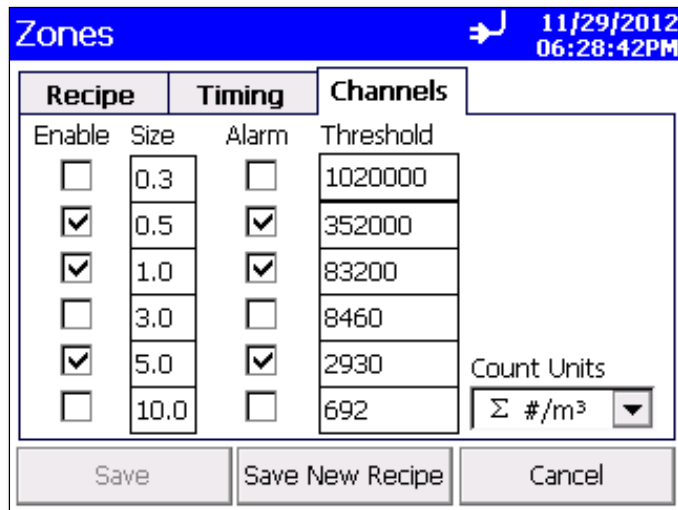

Zones				11/29/2012 06:28:42PM
Recipe		Timing	Channels	
Enable	Size	Alarm	Threshold	
<input type="checkbox"/>	0.3	<input type="checkbox"/>	1020000	
<input checked="" type="checkbox"/>	0.5	<input checked="" type="checkbox"/>	352000	
<input checked="" type="checkbox"/>	1.0	<input checked="" type="checkbox"/>	83200	
<input type="checkbox"/>	3.0	<input type="checkbox"/>	8460	
<input checked="" type="checkbox"/>	5.0	<input checked="" type="checkbox"/>	2930	
<input type="checkbox"/>	10.0	<input type="checkbox"/>	692	
				Count Units Σ #/m³ ▼
Save		Save New Recipe		Cancel

8. This tab can be used to view or set the particle size for each channel (not supported in all models), enable/disable the channel, enable/disable alarm for each channel and set the alarm threshold for each channel. The threshold values are expressed in the units selected in the **Count Units** control. Select the appropriate **Count Units** from the list.

During sampling, when a channel value exceeds the threshold value set here, the channel data is highlighted in red on the Main screen, an audible alarm sounds, and the alarm icon.

To acknowledge the alarm and silence the buzzer, tap the alarm icon .

NOTES

- In **Differential modes (Δ)**, disabling one or more channels will disable all threshold alarms. Other alarms are not affected.
- While in **beep mode**, a threshold of 0 will not trigger an audible alarm even if Alarm is enabled.
- **Concentration display** is unavailable in Beep mode.

9. Press **Save** or **Save New Recipe** as appropriate when done.

NOTE

The **Channel Configuration** screen has restrictions that must be noted when **Differential mode (Δ)** is selected.

When **differential Δ particle count or concentration (Δ)** is selected, the total number of counts is the number of particles *between* enabled bin sizes. When particle concentration is cumulative (Σ), the total number of counts includes all particles larger than the bin size.

In **Differential Display/Alarm** mode, there are two constraints:

- If alarming is desired, *all* channels must be *enabled*.
- If channel selection is desired, then *all* alarms must be *disabled*.

The controls work in a mutually exclusive manner. When any of the channel **“Enable”** boxes are unchecked, all **“Alarm”** enable boxes will be cleared. When any of the **“Alarm”** boxes are checked, all of the channel **“Enable”** boxes will become checked.

For the **Cumulative** modes (Σ), there are no such constraints. Any combination of **“Enable”** and **“Alarm”** selections can be made.

System Setup Screen

Use the **System Setup** screen to select or change:

- Power On Password
- Setup Password
- Configuration parameters
- Print Setup
- Print Schedule
- Clear Samples



Change Power On Password Screen

If a **Power On** password is set, a password is required before the instrument will operate. If a **Power On** password has been previously set, that password must be entered before choosing a new **Power On** password. A blank in the password field is considered no password, so if set as a new password, the instrument will not prompt for a password on system startup.

NOTE

Keep the password in a safe place. It is difficult to reset the password and requires contacting the factory. If the password has been misplaced, please contact [TSI technical support](#).

Tap the **Power On** password icon to display the on-screen keyboard and enter the required information.

Field	Description
Old Password	Enter your existing password (if one has already been set) or leave blank.
New Password	Enter a new password. The password can be any length and use any characters.
Confirm New Password	Retype the new password then press OK . A confirmation message appears if the password is changed.

NOTE

Leave both **New Password** and **Confirm New Password** fields blank to turn off password protection.

Contact [TSI](#) if the password is forgotten.

Change Setup Password Screen

If a Setup password is set, a password must be entered to change instruments settings. On the main screen, selecting the **Setup** tab at the bottom will display a password screen. If a Setup password has been previously set, that password must be entered before choosing a new Setup password.

NOTE
<p>Enabling a password for the Setup protects against a user changing instrument settings. These settings may include creating/changing zones, locations, and sample recipes.</p> <p>You can still use the existing zones, locations, recipes, create reports, and transfer data. You would need the password to change any of these functions.</p>

Tap the **Setup Password** icon to display the on-screen keyboard and enter the required information.

Field	Description
Old Password	Enter your existing password (if one has already been set) or leave blank.
New Password	Enter a new password. The password can be any length and use any characters.
Confirm New Password	Retype the new password then press OK . A confirmation message appears if the password is changed.

NOTE
<p>Leave both New Password and Confirm New Password fields blank to turn off password protection.</p> <p>Contact TSI if you have forgotten the password.</p>

Configuration Screen

Use the **Configuration** screens to set configuration parameters. Press **OK** when finished.

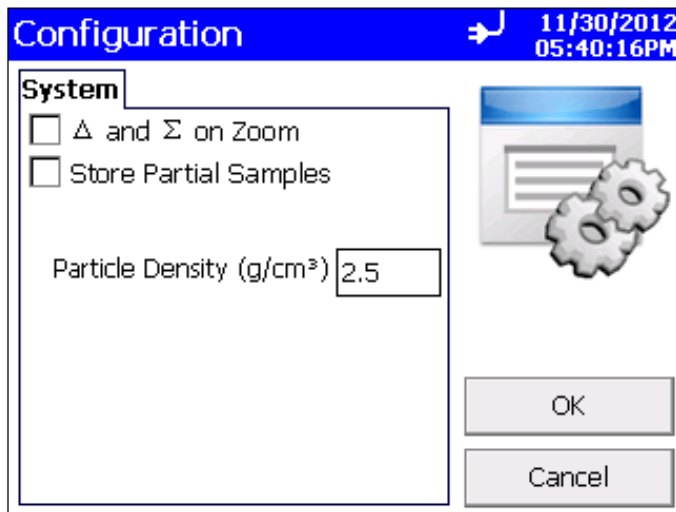

Field	Description
Δ and Σ on Zoom	When selected, tapping the left side of Main tab on the instrument's screen will zoom (enlarge) both cumulative (Σ) and differential (Δ) counts (allow the screen a moment to update). Tap on the screen again to return to normal view.
Store Partial Samples	When selected, if the instrument stops during a sampling period, the database will record the partial sample data.
Alarm Volume Level	Controls the alarm volume setting.
Particle Density	Enter the particle density value that will be used to calculate mass concentrations for display, print and export of sample data.

Print Setup Screen

A hard copy of a sample set or statistics can be printed from the instrument using an optional thermal printer. Use this screen to set print parameters. Press **OK** when finished. These selections will apply when printing automatically or when printing from the Data tab page.

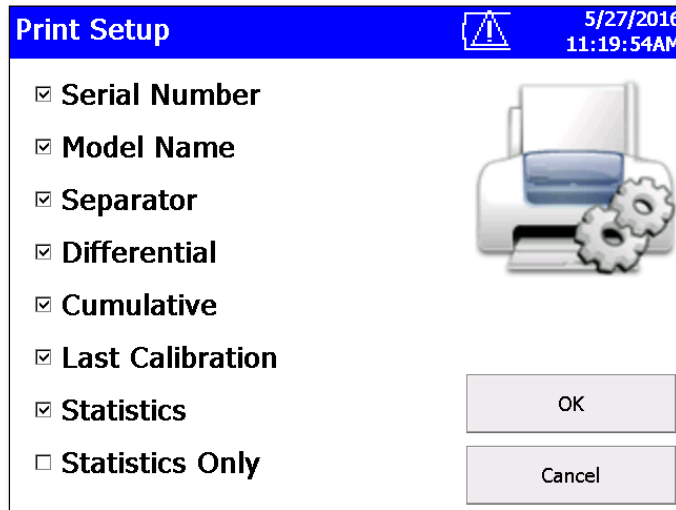

Field	Description
Serial Number	Indicates that the serial number of the particle counter used to collect the data will be printed.
Model Name	Indicates that the model number of the particle counter used to collect the data will be printed.
Separator	Indicates a line separator will be printed after the Model Name and Serial Number in the header of all printouts
Differential	Indicates that the differential value of the data will be printed.
Cumulative	Indicates that the cumulative value of the data will be printed.
Last Calibration	The date and time the instrument was last calibrated by TSI.
Statistics	A statistical summary is printed after the sample data.
Statistics Only	A statistical summary is printed instead of sample data.

NOTE

Printer paper has a colored strip printed on the last few feet of each roll to indicate when it is time to change the paper roll.

Print Schedule Screen

Use the **Print Schedule** screen to schedule automatic printing. Choose to either print when an alarm occurs or whenever a sample is complete.

“**English Only Printing**” will print reports in English even when the selected language is not English. The default zones and locations will print in English. If zones or locations have been created with names in other languages, the names are not translated to English.

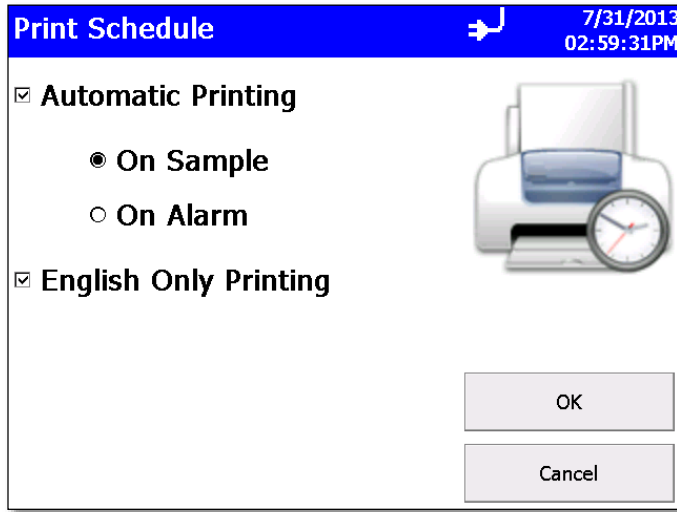

The screenshot shows a mobile application interface for scheduling printing. At the top, a blue bar contains the title 'Print Schedule' and a date/time stamp '7/31/2013 02:59:31PM'. Below this, there are three checked options: 'Automatic Printing', 'English Only Printing', and 'On Sample'. The 'On Sample' option is selected with a radio button. To the right of these options is an icon of a printer with a clock. At the bottom of the screen, there are two buttons: 'OK' and 'Cancel'.

Field	Description
Automatic Printing	Enables automatic printing when checked.
On Sample	Print data whenever a sample completes.
On Alarm	Print data when an alarm condition occurs.
English Only Printing	Always print data in English.

Clear Samples Screen

Use the **Clear Samples** screen to clear all samples from the internal database. Select **Yes** to clear all samples. Select **No** to return to the System Setup screen.

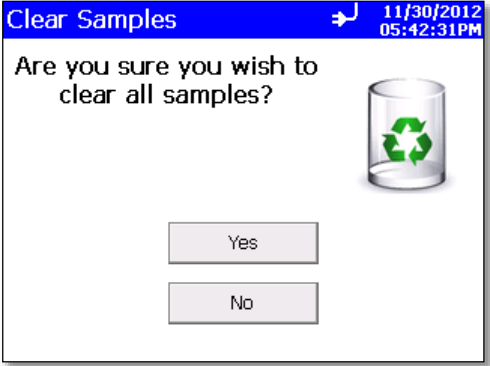

CAUTION	
WHEN "YES" IS SELECTED ON THE CLEAR SAMPLES SCREEN, ALL SAMPLE RECORDS WILL BE DELETED FROM THE INSTRUMENT! THERE IS NO WAY TO RECOVER THEM ONCE THEY HAVE BEEN DELETED.	

Information Screen

Use the **Information** screen to view the following on the system:

- Model Number
- Serial Number
- Copyright
- Manufacture Date
- Last Calibrated
- Calibration Due
- Firmware Version
- Ethernet IP Address
- USB IP Address
- Date Format
- Time Format

Press **Close** when finished.

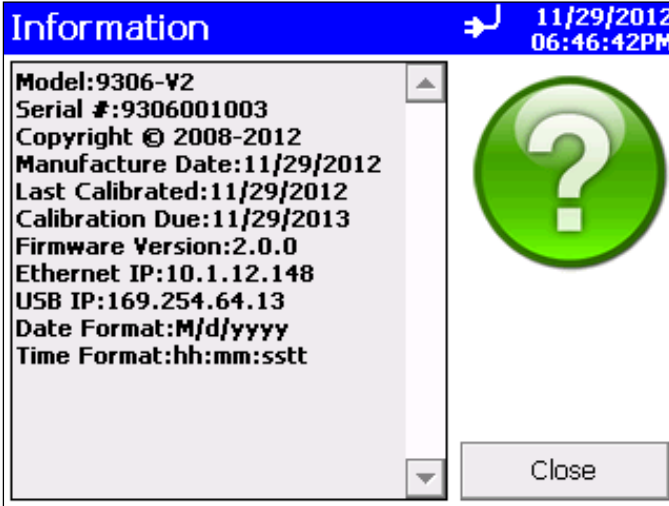

Device Setup Screen

Use the **Device Setup** screen to access screens that let you set or change the date and time, calibrate the touch screen, set up communications, and set regional features.

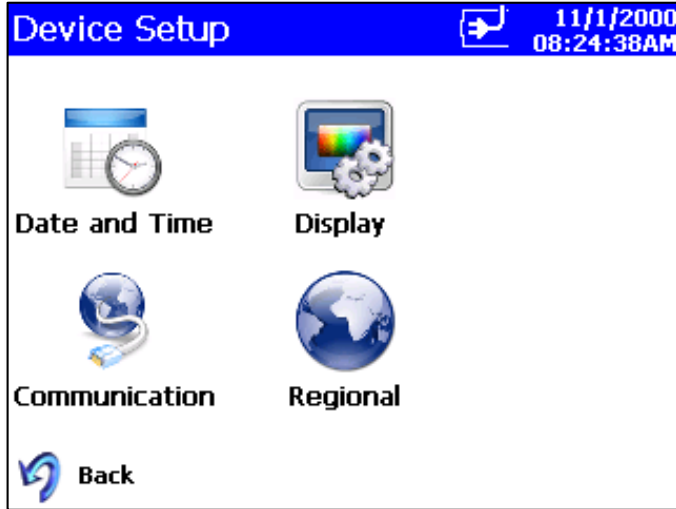

Date and Time Screen

Use the **Date and Time** screen to set the current date, time, and the time format. Press **OK** when finished. Select options using the arrows or tapping on the screen which displays the keypad.

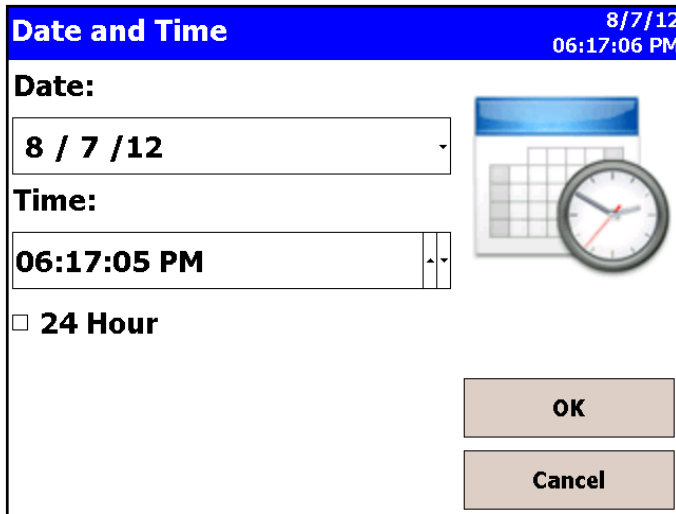

Field	Description
Date	Press the down arrow to display a calendar then select the date from the calendar.
Time	Select the time component you want to change (hours; minutes; seconds) and then use the left and right arrows to adjust to the current time.
24 Hour	Time display is in 24 hour format when checked.

Display Screen

Use the **Display** screen to calibrate the touch screen.



Field	Description
Screen Alignment	<p>Press this item to reset the screen alignment. Follow the directions on the alignment screen.</p> <p>NOTE</p> <p>The touch screen display is aligned at the factory and typically will stay aligned for the life of the instrument. Only perform this alignment if tapping on the on-screen controls seems to give poor results.</p>

Communications Screen

Use the **Communications** screen to configure the following:

- IP address
- Subnet Mask
- Default Gateway (to which the instrument belongs)

Addresses can be entered using the arrows or by selecting a field and using the on-screen keypad.

The screenshot shows a 'Communications' screen with a blue header bar. The header contains the title 'Communications', a right-pointing arrow, and the date and time '4/30/2010 8:47:44 AM'. Below the header, there are three input fields with up/down arrows on the right side: 'IP Address' with the value '010 .001 .001 .000', 'Subnet Mask' with '255 .255 .255 .000', and 'Default Gateway' with '010 .001 .001 .254'. To the right of these fields is an icon of a globe with a network cable. At the bottom left, there is a checkbox labeled 'Use DHCP' which is currently unchecked. At the bottom right, there are two buttons: 'OK' and 'Cancel'.

Field	Description
IP Address	The numerical identification (logical address) that is assigned to this device when participating in a computer network utilizing the Internet Protocol for communication between its nodes.
Subnet Mask	A network of computers and devices that have a common, designated IP address routing prefix. All hosts within a subnet can be reached in one "hop" (time to live = 1), implying that all hosts in a subnet are connected to the same link.
Default Gateway	A node on the computer network that serves as an access point to another network and is chosen when the IP address does not belong to any other entities in the Routing Table.
Use DHCP (Dynamic Host Configuration Protocol)	When checked, this protocol is used to automatically obtain the information necessary for operation from a DHCP server running on your local network.

NOTE

TCP/IP is an industry standard networking protocol that allows computers and devices to communicate over Ethernet and other media access channels. Providing full details on how to configure an IP network is beyond the scope of this manual. Please contact your company IT department or a qualified networking professional if you are not qualified to configure such a network.

Regional Screen

Use the **Regional** screen to set the language for the display dialogs and the regional format for numbers.



Field	Description
Language	Select the language for the display; options are German, English, Spanish, French, Italian, Chinese (simplified), and Japanese.
Formats	Select the format that is commonly used to display real numbers and the date and time in your region.

Environment Screen

When a temperature, humidity, or air flow velocity sensor is connected to the instrument, use the **Environment** screen to set the units that will display on the Main and Data Tabs, and in the printouts.

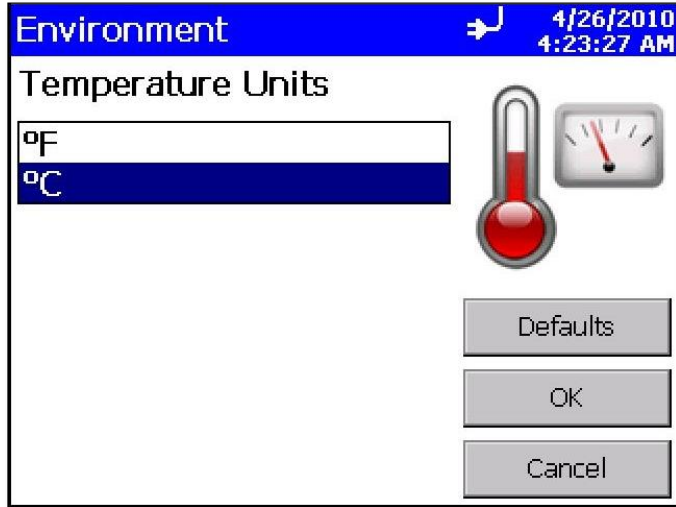

Field	Description
°F	Display temperature in degrees Fahrenheit.
°C	Display temperature in degrees Celsius.

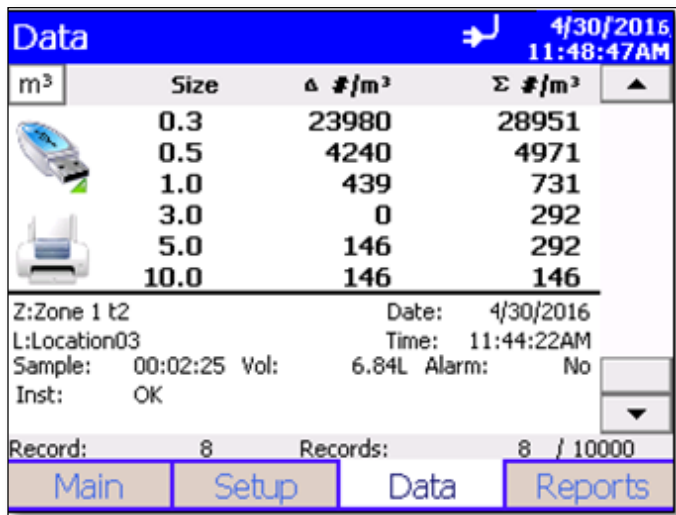

Data Tab

Use the **Data** tab to preview data that has been collected. To scroll through the records, use the elevator (slide) on the right. The record number is displayed at the bottom of the tab. As each record displays, its data and relevant parameters are displayed.



NOTE

Counts displayed on the data tab concentration may have slight rounding errors when comparing all channels to values with selected channels enabled. The method for calculating concentration is to sum the raw counts for each location, calculate concentration from sample volume and then round. This may result in slight rounding errors when comparing counts with all channels enabled versus concentrations with selected channels enabled. The methodology utilized is covered in ISO 14644-1 Annex D.

Field	Description
#, ft³, m³, µg	Button used to change between counts and concentration displays: # = number ft ³ = particles per cubic foot m ³ = particles per cubic meter µg = micrograms per cubic meter (mass concentration)
Size	Channel size.
Δ	Differential mode.
Σ	Cumulative mode.
	Export the data to a flash drive. See Export Data Screen below.
	Print data to the optional printer. See Print Data below
Zone (Z)	Zone where the data was collected.
Location (L)	Location where the data was collected.
Sample	Duration of the sampling period.
Date	Date on which the data was collected.
Time	Time at which data was collected.
Temp	Temperature at the end of the time the data was collected (if probe connected during sampling).
RH	Humidity level at the end of the time the data was collected (if probe connected during sampling).
Alarm	Alarm threshold was triggered (Yes) or not (No).
Inst	Status of the instrument hardware. OK if no issues or error abbreviation if instrument has a possible issue.
Vol	Volume of air that was sampled.
Record	This record number.
Records	Total number of records.

Export Data Screen

Use the **Export Data** screen to export sample data to a USB flash drive. Select the name of the file and range of data to export. Data is downloaded into an XML file that can be opened with commonly used spreadsheet programs.

To Export Data

1. Click the USB drive icon on the Data tab. The **Export Data** screen appears.

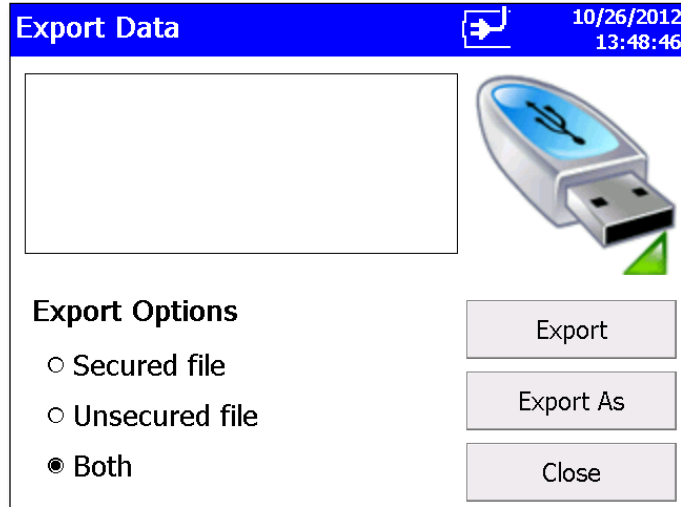

Field	Description
Secured file	This file is intended to be used with TrakPro Lite Secure software and maintains CFR 21 Part 11 compliance. The file has the extension <i>file name_sec.xml</i> .
Unsecured file	This file is intended for user input into Excel for graphing and data manipulation purposes and has the extension <i>file name.xml</i> .
Both	If using both file types, both file formats can be exported. Please note that the data export time is longer when both file formats are exported.



CAUTION	
DO NOT modify the secure file. If the “_SEC” secure file is modified, TrakPro Lite Secure software will not be able to open the file.	

2. Select a file from the list and click:
 - a. **“Export”** to overwrite an existing file selected from the file list.
 - b. **“Export As...”** to enter a filename. Then select **OK**.

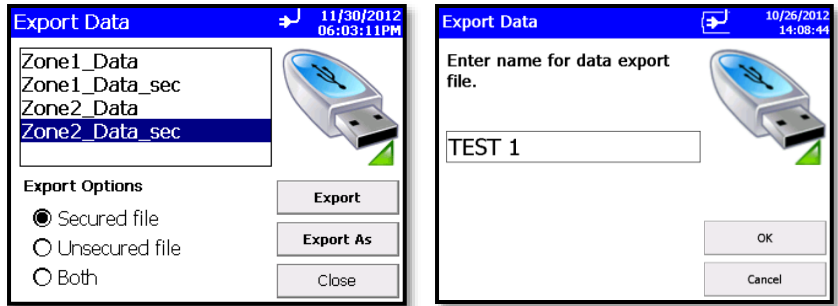

3. Select **Sample Data by Zone** or by **Sample** index range with option of limiting samples to a date range.
 - a. Check **“Use Start Date”** checkbox and select a start date to exclude data that was collected prior to that start date.
 - b. Check **“Use End Date”** checkbox and select an end date to exclude data that was collected after that end date. Date is displayed as month/day/year.

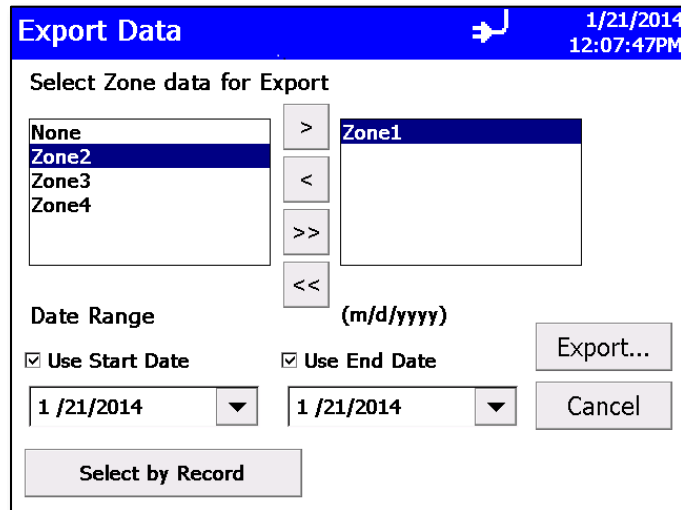

- To select data for export by zone, move a desired zone to the box on the right to select it. To select data by sample index range instead, tap the **Select by Record** button at the bottom.

- To select data for export by range of sample Index, tap **Select Range** radio button and then select the lower and upper sample index numbers. To select data for export by zone instead, tap the **Select by Zone** button at the bottom.
- Once the records or the Zones have been selected, press **Export...** to begin exporting. Status screens allow viewing the progress of the export.



or

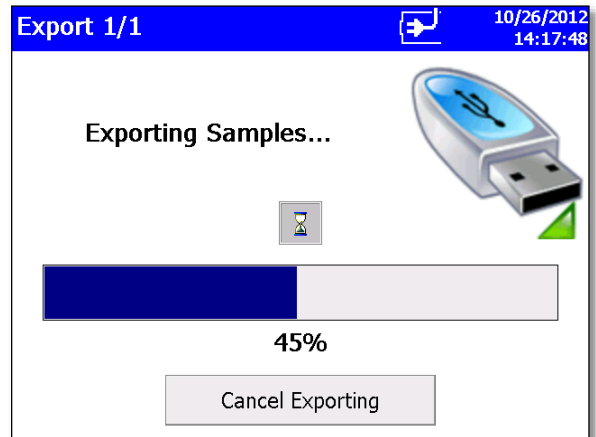

CAUTION

DO NOT remove the external drive during the export process. If the thumb drive is removed, re-insert and restart the download process. Data stored on the instrument is not lost during the transfer.

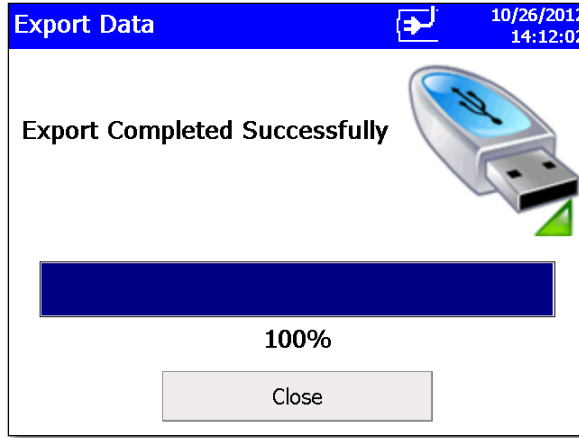

Print Data

The print button allows a range of sample data to be printed using the optional printer.

- The “**Print by Record**” form or the “**Print by Zone**” form can be used. Both forms provide the option to limit data selection to a date range.
- Check the “**Use Start Date**” checkbox and select a start date to exclude samples collected before that date.
- Check the “**Use End Date**” checkbox and select an end date to exclude samples collected after that date.
- Check the “**Recipe**” checkbox to include recipe details for each recipe used in the report.

To Print Data

1. Click the **Printer** icon on the Data tab. The “**Print by Zone**” screen appears.

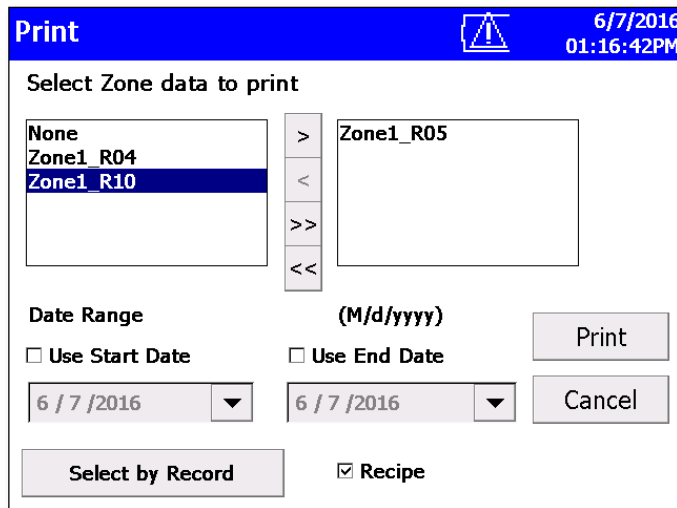

2. Move a zone to the box on the right to select it for printing.
3. Alternatively, print samples within a date range by checking **Use Start Date** and/or **Use End Date** checkboxes and selecting the dates.
4. To the **Select by Record** button at the bottom to select data by range or sample index.

5. The **“Select by Record”** screen above allows you to select data by range of sample index number.
 - a. Tap the **Select Range** radio button and select the lower and upper sample index numbers.
 - b. To select data by zone instead, tap the **Select by Zone** button at the bottom.
6. To filter the data by start and/or end date, check the appropriate checkboxes and select the date.
7. Check **“Recipe”** to include the details of each recipe used by samples that are included in the report.
8. Once you have identified the records or Zones to print, press the **Print** button.

9. The print data screen shows progress on the current selected range of sample data. Press the **Cancel Printing** button to cancel the rest of the print job.

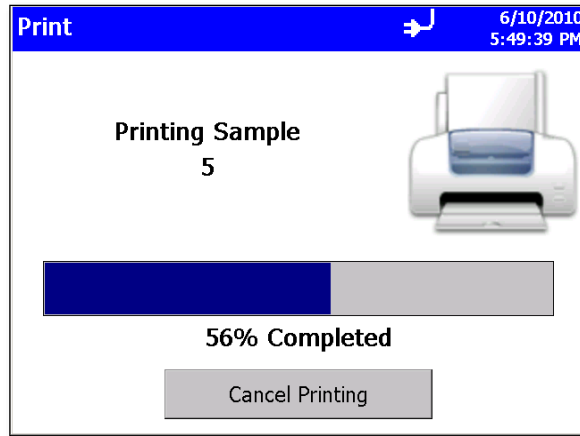

Printouts that include sample data will identify the samples as “**Sample X of Y**” where **X** is the current sample in the set (not the sample ID for the sample) and **Y** is the total number of samples in a set being printed (not the total number of samples on the instrument).

Reports Tab

Use the **Reports** tab screen to select various standard reports for viewing and printing.

1. Select a zone to be included in the report. You have the option to restrict data to a date range.
 - a. Check the “**Use Start Date**” checkbox and enter a start date to exclude data collected before that date.
 - b. Check the “**Use End Date**” checkbox and select an end date to exclude data collected after that date.

2. Check the “**Recipe**” checkbox to include recipe details on the report.

Reports 5/26/2016 10:15:19AM

Standard
ISO 14644-1:2015

Class 4.5 Zone Zone1_R04

Generate

Date Range (M/d/yyyy)
 Use Start Date Use End Date Recipe

5/26/2016 5/26/2016

Exclude Samples Excl: [dropdown]

Main Setup Data Reports

3. When you press the **Generate** button, you are given the option to enter a title for the report.
4. Enter a title or leave the text box blank.
5. Press the **Enter** key on the visual keyboard or press the **Close** button to close the form and generate the report.

Report Title: Zone 1 Report

Input Panel

Esc 1 2 3 4 5 6 7 8 9 0 - = Backspace

Tab q w e r t y u i o p [] \

Caps Lock a s d f g h j k l ; ' Enter

Shift z x c v b n m , . /

Ctrl Del Home End

Close

6. Report will show the title you provided.

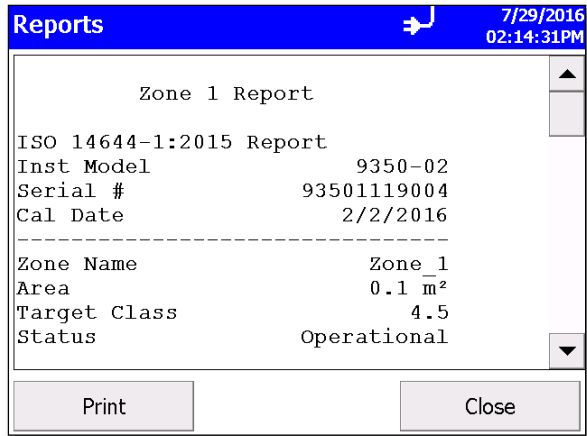

Field	Description
Zone	Select the zone from the drop-down list.
Standard	Select the standard from the drop-down list.
Class	Select the class from the drop-down list.
Use Start Date	Exclude samples collected before a specified date.
Use End Date	Exclude samples collected after a specified date.
Recipe	Check to include the recipe details on the report.
Exclude Samples button	Press Exclude Samples button to display Exclude Samples form which allows you to exclude samples from report if allowed by selected standard. IDs of samples you exclude on that form will be displayed in list box to right of this button.
Generate	Press to begin generating a report that you can view on-screen or print.

Exclude Samples Form

The “**Exclude Samples**” form shown below is displayed when you click the **Exclude Samples** button.

The screenshot shows a window titled "Exclude Samples" with a white background and a blue title bar. The window contains two columns of input fields. The left column is labeled "Exclude #:" and has five text boxes, with the first containing the number "15". The right column is labeled "Replacement #:" and has five text boxes, with the first containing the number "21". At the bottom of the window, there are two buttons: "Save" and "Clear".

1. Enter ID number of sample to exclude in the left column and ID number of sample to replace it (if required by standard) in right column. You can exclude up to five samples and replace them with other samples for ISO 14644-1:2015. If the standard allows you to exclude only one sample (e.g., ISO 14644-1:1999) only the first text box in the left column will be enabled and the replacement text boxes will all be disabled.
2. Press the **Save** button to exclude the specified samples from the report.
3. Press the **Clear** button to erase the content of the text boxes and cancel the exclusion of samples from the report.

Data Integrity Mode

Data Integrity Mode allows the unit to be locked down to ensure the sampling data cannot be modified. When in this mode, all printing and data exporting is prohibited.

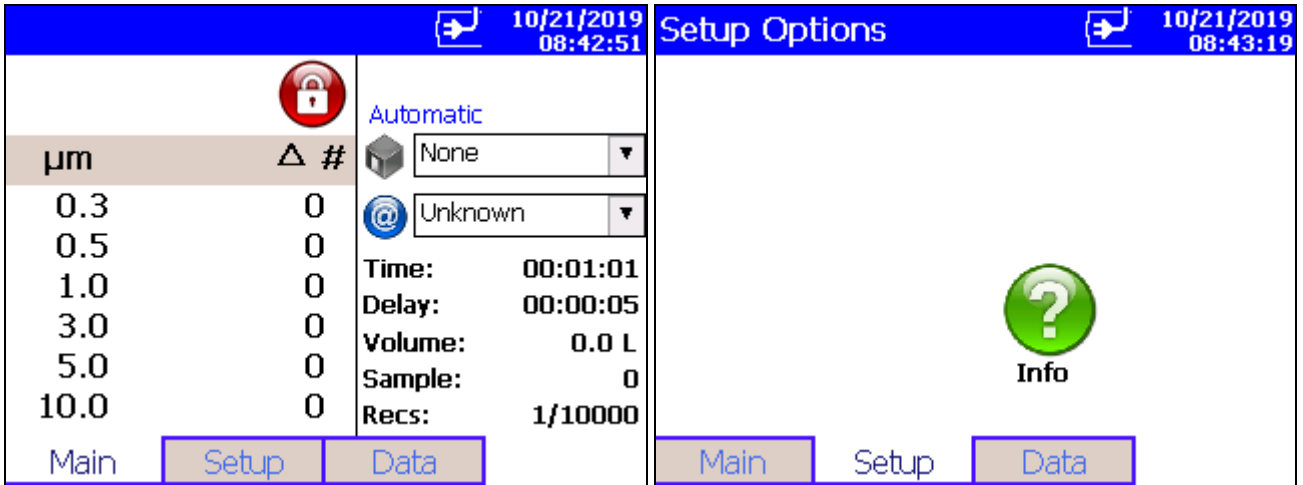

Data Integrity Mode is designed to be used in conjunction with TrakPro Lite Secure software. When enabling data integrity mode on the instrument, only the data can be viewed.

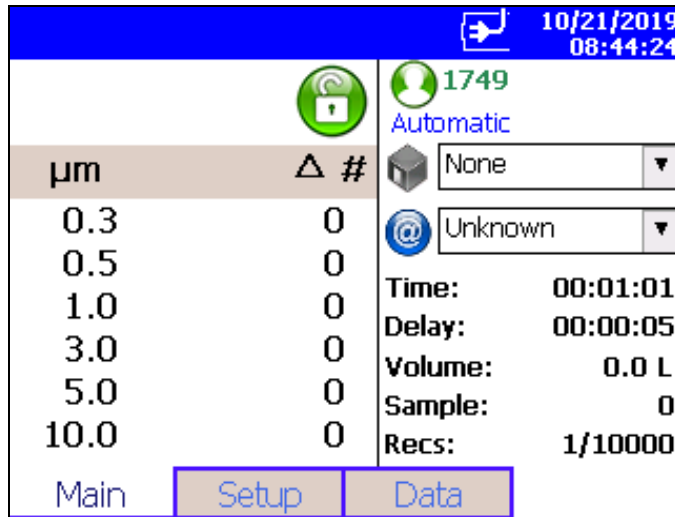

The lock icon  on the main page indicates the unit is in data integrity mode, but no user is logged in.

To allow sampling, the unit will need to be unlocked using TrakPro Lite Secure software. During this process TrakPro Lite Secure software will place the user ID # and password into the instrument to allow you to take samples.



The unlock icon  on the main page indicates the instrument is in data integrity mode and unlocked. The user icon 1749 indicates which user has the instrument unlocked in data integrity mode.

Now that the instrument is unlocked for sampling, a zone and location can be selected. When this selection is first initiated the instrument will prompt for a password.

NOTE

The password is the same password used when you logged into TrakPro Lite Secure software.



10/21/2019
08:44:58

Password
1749

OK
Cancel

If an incorrect password is entered, you will not be able to start a sample.

A password needs to be entered when the unit first starts, or when the first sample is taken after disconnecting from TrakPro Lite Secure software; or after a timeout that was programmed from TrakPro Lite Secure software. The timeout is the time after a sample is complete until the new sample begins.

After a zone and location has been selected and password entered, the green start sample icon will appear and sample(s) can be taken.

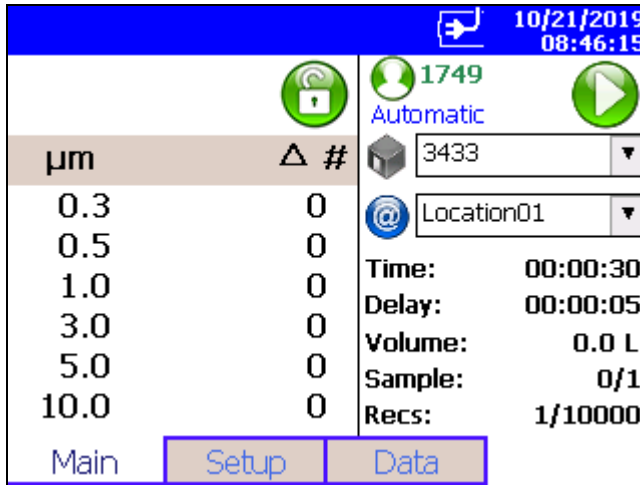

After a sample is complete, the instrument defaults to no zone and no location; the start sample icon will no longer be available. A zone and location will need to be selected to enable the start sample icon.

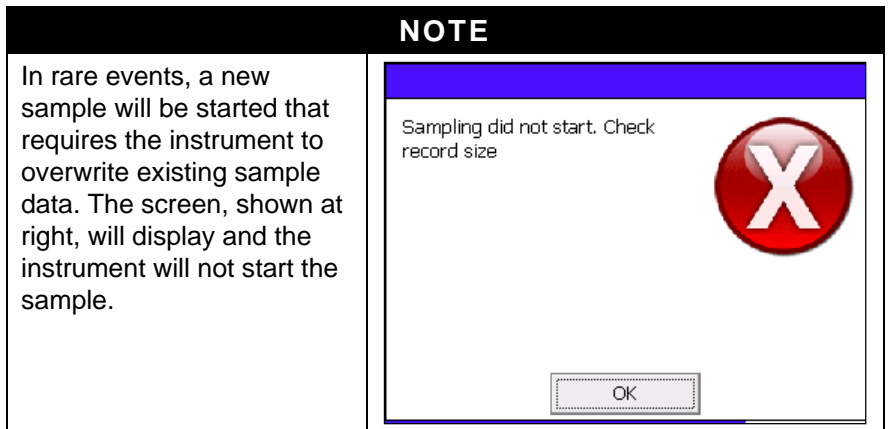

(This page intentionally left blank)

CHAPTER 4

Data Handling

USB Data Download

The Model 9306 AeroTrak® Handheld Airborne Particle Counter is equipped with a USB A host drive that allows data downloads to a USB flash drive (commonly called a USB thumb drive). To download data, attach a flash drive to the USB A host port and follow



the instructions in the [operation section](#) of this manual. The data is downloaded in XML format that can be opened in Microsoft Excel® spreadsheet program version 2003 or greater. The data files can also be opened in the latest versions of OpenOffice™ application.

USB Computer Communication

The Model 9306 AeroTrak® Handheld Airborne Particle Counter is equipped with a USB compatible cable for uploading and downloading information to a PC. The cable plugs into the side of the instrument.



Installing Software

See the *TrakPro™ Lite Secure Software (version 3.0 or later) User's Guide* (P/N 6004404) on CD (P/N 7001901) for installation instructions.

Ethernet Communications

An Ethernet port is provided for use with TSI Facility Monitoring Software (FMS). Refer to the FMS Software documentation and the TSI service and installation manual for detailed configuration and operation information on Modbus® TCP over Ethernet.



CHAPTER 5

Maintenance

The chapter contains maintenance and troubleshooting solutions for the Model 9306 AeroTrak® Handheld Airborne Particle Counter.

NOTE

There are no user-serviceable parts inside this instrument. Opening the instrument case may void the warranty. TSI recommends that the AeroTrak® Airborne Particle Counter be returned to the factory for any required maintenance or service not described in this manual.

Maintenance Schedule

TSI recommends annual factory cleaning and calibration for the AeroTrak® Airborne Particle Counter. See [Chapter 7, "Contacting Customer Service"](#) for service/calibration.

Recommended Field Maintenance Schedule

Item	Frequency
Zero check	Daily or according to application.
Factory cleaning and calibration	Annually.
Cleaning the instrument enclosure	As needed.

Zero Check

The zero check ensures that the instrument is properly assembled and free from leaks, residual particles and electronic noise.

Cleaning the Instrument Enclosure



To clean the enclosure, dampen a lint-free cloth and gently wipe the surface until surface contamination is removed.

(This page intentionally left blank)

CHAPTER 6

Troubleshooting

Symptom	Possible Cause	Corrective Action
Counts are too low.	<p>Instrument is being operated outside temperature or relative humidity specifications.</p> <p>Internal parts have been damaged because instrument was stored at a temperature greater than 122°F (50°C).</p> <p>Instrument has contamination on the optics due to condensation or excessive loading.</p> <p>Laser or pump control is damaged.</p> <p>Unit is due for calibration.</p>	<p>Operate instrument within specifications.</p> <p>Return to factory or factory authorized service centers for service.</p> <p>Return to factory or factory authorized service centers for service.</p> <p>Return to factory or factory authorized service centers for service.</p> <p>Return to factory or factory authorized service centers for service.</p>
Instrument does not turn on.	<p>Battery is not charged.</p> <p>AC cord is not plugged into unit.</p>	<p>Recharge battery or connect to AC power.</p> <p>Connect AC cord.</p>
Instrument does not meet zero count specification (<1 particle/5 mins).	<p>Particles are in the instrument chamber.</p> <p>HEPA filter is not connected properly and room air is leaking into the HEPA filter assembly.</p> <p>Residual particles from previous samples are shedding off internal parts and into the optics.</p> <p>An internal component has been damaged due to operation outside of temperature specifications or one or more excessive bumps or jolts, and electronic noise is inducing false counts.</p> <p>A leak has developed in the aerosol flow path.</p> <p>Internal optics have become dirty.</p>	<p>Run the instrument for one-half hour with a filter and then recheck the zero count.</p> <p>Check that the HEPA filter has been tightly connected to the inlet. Check that rubber O-ring (black) on the inlet is in place.</p> <p>Purge instrument by running the instrument for 10 to 15 minutes before attempting zero count test. If instrument has heavier contamination, purge of 1 hour or longer may be needed.</p> <p>Return to factory or factory authorized service centers for service.</p> <p>Return to factory or factory authorized service centers for service.</p> <p>Return to factory or factory authorized service centers for service.</p>

Symptom	Possible Cause	Corrective Action
Battery does not charge.	The unit must be turned on but not in sampling mode for the battery to charge. Unit not put in Standby Mode.	Turn on unit. The battery will only charge if the unit is turned on but is not actively taking a sample. Select Standby/Charge when shutting off the instrument if you want the battery to be charged. NOTE When charging in "Standby Mode," the instrument will shut down when fully charged.
LOW BATTERY ERROR 	Low battery.	Recharge battery or connect AC cord.
SYSTEM ERROR	Information is not being read properly by microprocessor.	Restart instrument. If problem persists, contact TSI technical support.
TEMPERATURE HUMIDITY PROBE ERROR	Temperature/RH probe was not recognized.	Detach and reconnect probe. If problem persists, contact TSI technical support.
FLOW ERROR 	Instrument was unable to control flow rate (if any tubing is connected to particle counter). Pressure drop across inlet may be too large. Inlet not at ambient pressure.	Restart measurement. Lessen pressure drop across inlet by using larger diameter tubing, less tubing, and/or adding a bleed valve. DO NOT subject the unit to other than ambient pressure conditions.
LASER POWER / DETECTOR WARNING 	Excessive direct light is entering the aerosol inlet. Optical path blocked. Nozzle is misaligned. Fiber attached on the nozzle tip. Detector board damaged. Laser power is normal.	Remove instrument from direct light. Return to factory for service. Contact TSI and return to factory. Return to factory or factory authorized service centers for service.

CHAPTER 7

Contacting Customer Service

This chapter gives directions for contacting people at TSI Incorporated for technical information and directions for returning the Model 9306 AeroTrak® Handheld Particle Counter for service.

Technical Contacts

- If you have any difficulty setting up or operating the AeroTrak® Model 9306, or if you have technical or application questions about this system, contact an applications engineer at TSI Incorporated, 1-800-680-1220 (USA) or (651) 490-2860 or e-mail technical.services@tsi.com.
- If the AeroTrak® Model 9306, does not operate properly, or if you are returning the instrument for service, visit our website at tsi.com/service, or contact TSI Customer Service at 1-800-680-1220 (USA) or (651) 490-2860.

International Contacts

Service

TSI Instruments Singapore Pte Ltd
150 Kampong Ampat
#05-05 KA Centre
Singapore 368324

Telephone: +65 6595-6388
Fax: +65 6595-6399
E-mail: tsi-singapore@tsi.com

TSI Instrument (Beijing) Co., Ltd.
Unit 1201, Pan-Pacific Plaza
No. 12 A, Zhongguancun South Avenue
Haidian District, Beijing, 100181
CHINA

Telephone: +86-10-8219 7688
Fax: +86-10-8219 7699
E-mail: tsibeijing@tsi.com

TSI Instruments Ltd.

Stirling Road
Cressex Business Park
High Wycombe, Buckinghamshire
HP12 3ST
UNITED KINGDOM

Telephone: +44 (0) 149 4 459200

E-mail: tsiuk@tsi.com

Technical Support**TSI Instruments Singapore Pte Ltd**

150 Kampong Ampat
#05-05 KA Centre
Singapore 368324

Telephone: +65 6595-6388

Fax: +65 6595-6399

E-mail: tsi-singapore@tsi.com

TSI Instrument (Beijing) Co., Ltd.

Unit 1201, Pan-Pacific Plaza
No. 12 A, Zhongguancun South Avenue
Haidian District, Beijing, 100181
CHINA

Telephone: +86-10-8219 7688

Fax: +86-10-8219 7699

E-mail: tsibeijing@tsi.com

TSI GmbH

Neuköllner Strasse 4
52068 Aachen
GERMANY

Telephone: +49 241-52303-0

Fax: +49 241-52303-49

E-mail: tsigmbh@tsi.com

TSI Instruments Ltd.

Stirling Road
Cressex Business Park
High Wycombe, Buckinghamshire
HP12 3ST
UNITED KINGDOM

Telephone: +44 (0) 149 4 459200

E-mail: tsiuk@tsi.com

TSI France Inc.

Hotel technologique
BP 100
Technopôle de Château-Gombert
13382 Marseille cedex 13
FRANCE

Telephone: + 33 (0)1 41 19 21 99

Fax: + 33 (0)1 47 86 00 07

E-mail: tsifrance@tsi.com

Returning the AeroTrak[®] Handheld Airborne Particle Counter for Service

Visit our website at [tsi.com/service](https://www.tsi.com/service) and complete the on-line “Service Request” form or call TSI at 1-800-680-1220 (USA) or (651) 490-2860 for specific return instructions. Customer Service will need this information when you call:

- The instrument model number
- The instrument serial number
- A purchase order number (unless under warranty)
- A billing address
- A shipping address

Use the original packing material to return the instrument to TSI. If you no longer have the original packing material, seal off any ports to prevent debris from entering the instrument and ensure that the display and the connectors on the instrument front and back panels are protected.

(This page intentionally left blank)

APPENDIX A

Specifications

All specifications meet or exceed ISO 21501-4 and JIS B9921. They are subject to change without notice.

Specification	Description
Size Range	0.3 to 25 µm
Channel Sizes	Standard: 0.3, 0.5, 0.7, 1.0, 2.0, 5.0 µm Standard: 0.3, 0.5, 1.0, 3.0, 5.0, 10.0 µm Standard: 0.3 to 10 µm, user-selectable; factory-calibrated at 0.3, 0.5, 1.0, 3.0, 5.0, 10.0 µm. Additional channel sizes available
Size Resolution	<15% at 0.5 µm (per ISO 21501-4 requirements)
Counting Efficiency.....	50% at 0.3 µm; 100% for particles > 0.45 µm (per JIS and ISO 21501-4)
Concentration Limits	5,950,000 particles/ft ³ at 10% coincidence loss
Light Source	Long life laser diode
Zero Count Level	<1 count/5 minutes (per JIS B9921 and ISO 21501-4)
Flow Rate	0.1 CFM (2.83 L/min) with ±5% accuracy (meets JIS and ISO 21501-4 requirements)
Calibration	NIST traceable with TSI calibration system
Calibration Frequency	Recommended minimum once per year
Sample Probe/Tubing	Isokinetic sampling probe
Sampling Modes	Manual, automatic, beep, cumulative/differential count or concentration
Sampling Time.....	1 second to 99 hours
Sampling Frequency	1 to 9999 cycles or continuous
Exhaust	Internally filtered
Vacuum Source	Internal pump
Communication Mode.....	Modbus [®] TCP over Ethernet or USB
Data Storage	10,000 sample records: includes date, time, six particle channels, flow, ID, and sample volume; transferable via USB data download or TrakPro [™] Lite software
Data Security	Password protected
Alarm/Status	Audible alarm sounds for counts over threshold values set in recipe, low battery, and for instrument or flow errors.
Environmental Sensors	Optional temperature/RH probe supported
Display	QVGA 3.5-inch (8.9-cm) touch screen with Windows [®] CE operating system
Languages	English, Spanish, German, French, Italian, Japanese, and Chinese (simplified)
Reports.....	Provides Pass/Fail on FS-209E, ISO 14644-1 and EU GMP
Printer.....	Optional external printer supported

Specification	Description
External Surface	High impact injection molded plastic
AC Power (power to AC adapter) ...	110 to 240 VAC 50 to 60 Hz Universal in-line power supply
DC Power (power to instrument)	12 VDC @ 2.5 A
Battery	Removable/rechargeable Li-Ion
Battery Life	>Up to 7 hours of continuous use
Recharge Time	4 hours
Dimensions (L x W x H)	9.4 x 4.9 x 3.2 in.(23.9 x 12.4 x 8.1 cm)
Weight	1.0 kg (2.2 lbs.) with battery
Standards.....	CE, JIS B9921, ISO 21501-4 as listed above
Warranty.....	2 years. Extended warranties available
Operating Conditions.....	41 to 95°F (5°C to 35°C); 20% to 95% non-condensing relative humidity
Storage Conditions	32 to 122°F (0°C to 50°C); Up to 98% non-condensing relative humidity
Included Accessories	Power supply, power cord, battery, isokinetic inlet, stylus, purge filter, TrakPro™ Lite data download software, operational manual on CD, computer cable, calibration certificate, and Quick Start Guide.
Optional Accessories.....	Temp R/H probe, stainless steel isokinetic inlet and probe, tubing, barbed inlet fitting, printer, printer paper, carrying case and external battery charger

Temperature/RH Probe (700084) Specifications (optional accessory)

Temperature	
Range	32 to 115°F (0 to 45°C)
Accuracy	±4°F (±2°C)
Relative Humidity	
Range	10 to 90% RH
Accuracy	±5% RH

Compliance

CE Marking	EN61326 / EN 55011, Class BA: Radiated Emissions EN61326 / EN 55011, Class BA: Conducted Emissions EN61000-3-2: Harmonics EN61000-3-3: Voltage Fluctuations EN61000-4-2: Electrostatic Discharge Immunity EN61000-4-3: Electromagnetic Field Immunity EN61000-4-4: Burst Immunity EN61000-4-6: Conducted PS Immunity EN61000-4-5: Surge Immunity EN61000-4-8: Rated Power-Frequency Field Immunity EN61000-4-11: Voltage Dips\Short Interruptions Immunity
RoHS Marking	Yes

Dimensional Diagram

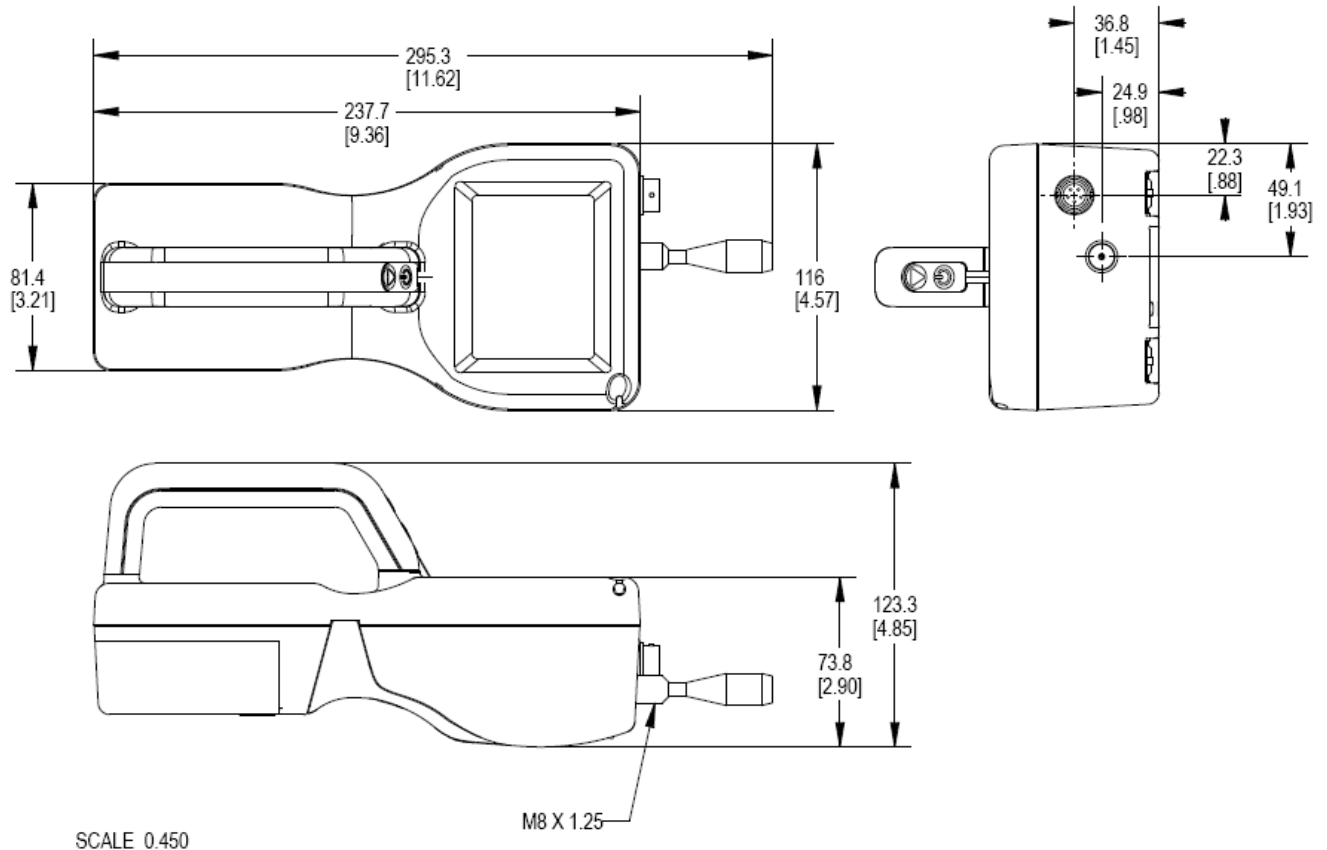

(This page intentionally left blank)

Index

2

24 hour, 3-26

A

AC power, A-2
accessories, A-2
 optional, 1-4, A-2
add zone, 3-10
air flow, 3-9, 3-39
alarm, 3-31
alarm volume level, 3-22
alarm/status, A-1
area, 3-9
automatic, 3-15
automatic printing, 3-24

B

barb inlet fitting, 1-4
battery, A-2
 charging, 2-3
 external charger, 1-4
 installation, 2-3
 life, A-2
 low battery error, 6-2
 not charging, 6-2
 pack, 1-2
 recharge time, A-2
battery low, 3-3
beep, 3-15
bin size, 3-7
both, 3-32

C

calibration, A-1
 maintenance, 5-1
calibration certificate, 1-3
calibration frequency, A-1
Calibration label, viii
cancel printing button, 3-37
carry case, 1-4
caution
 description, ix
 symbol, ix
CE marking, A-3
change setup, 3-21
change setup password
 confirm new password, 3-21
 new password, 3-21
 old password, 3-21
channel size, 3-31
channel sizes, A-1
class, 3-9

class level, 3-39
clear samples screen, 3-25
communication mode, A-1
communications
 default gateway, 3-28
 IP address, 3-28
 subnet mask, 3-28
 use dhcp, 3-28
communications screen, 3-28
compliance, A-3
computer cable, 1-2
concentration limits, A-1
configuration screen, 3-22
 particle density, 3-22
 store partial samples, 3-22
 volume, 3-22
 zoom, 3-22
confirm new password, 3-20, 3-21
contacting TSI, 7-1
 email address, iii
counting efficiency, A-1
counts too low, 6-1
cumulative, 3-23
cumulative mode, 3-31
customer service, 7-1

D

data handling, 4-1
data integrity mode, 3-41
data security, A-1
data storage, A-1
data tab, 3-30
 alarm, 3-31
 cumulative mode, 3-31
 date, 3-31
 differential mode, 3-31
 export data, 3-31
 laser, 3-31
 location, 3-31
 print data, 3-31
 record, 3-31
 records, 3-31
 RH, 3-31
 sample, 3-31
 size, 3-31
 temperature, 3-31
 time, 3-31
 vol, 3-31
 zone, 3-31
date, 3-26, 3-31

date and time
 24 hour, 3-26
 date, 3-26
 time, 3-26
date and time screen, 3-26
DC power, A-2
default gateway, 3-28
delay, 3-5, 3-17
delete zone, 3-10
detector warning, 6-2
device setup, 3-8
device setup screen, 3-26
differential, 3-23
differential mode, 3-31
dimensions, A-2, A-3
display, A-1
 screen alignment, 3-27
display screen, 3-27

E

edit zone, 3-11
edit zone screen, 3-11
English only printing, 3-24
environment screen, 3-30
environment setup, 3-8
environmental sensors, A-1
ESD protection, ix
Ethernet, 4-2
European symbol for non-disposable
 item, viii
exclude samples button, 3-39, 3-40
exclude samples form, 3-40
export data, 3-31, 3-32
export data screen, 3-32
 both, 3-32
 completed successfully, 3-35
 secured file, 3-32
 select range of data, 3-34
 select zone data for export, 3-33
 unsecured file, 3-32
external printer, 1-4
external surface, A-2

F

flow
 error, 6-2
flow rate, A-1
formats, 3-29
functionality, 3-2

G

generate, 3-39
getting help, x
getting started, 2-1

H

help, x, 7-1
HEPA zero filter assembly, 1-2
hold, 3-17

I

idokinetic inlet, 2-1
information, 3-8
information screen, 3-25
instrument description, 2-1
instrument enclosure
 cleaning, 5-1
 maintenance, 5-1
instrument not meeting zero count
 specification, 6-1
instrument not turning on, 6-1
introduction, 1-1
IP address, 3-28
ISO 14644-1
 1999, 3-40
 2015, 3-40
ISO 21501-4, A-2
isokinetic inlet, 1-2
 installation, 2-5
isokinetic probe, 1-4

J

JIS B9921, A-2

K

keyboard, 3-2

L

language, 3-29
languages, A-1
largest particle size to consider, 3-9
laser, 3-31
laser power warning, 6-2
laser radiation label, viii
laser safety, vii
last calibration, 3-23
light source, A-1
location, 3-5, 3-7, 3-31
location icon, 3-4
locations, 3-9
locations screen, 3-10, 3-12
locations tab, 3-10

M

main tab, 3-3
maintenance, 5-1
 schedule, 5-1
manual, 3-15
manual history, ii
manual/automatic/beep, 3-5
model name, 3-23

N

name, 3-9
new password, 3-20, 3-21

O

old password, 3-20, 3-21
on alarm, 3-24
on sample, 3-24
operating conditions, A-2
operation, 3-1

P–Q

packing instructions, 7-3
particle count/concentration, 3-7
particle density, 3-22
password
 changing, 3-21
 power, A-2
 providing, 2-3
 using, 2-4
power button, 2-1
power entry button, 2-1
power on password
 confirm new password, 3-20
 new password, 3-20
 old password, 3-20
power on password screen, 3-19
power supply, 1-2
print
 icon, 3-5
 schedule screen, 3-24
 setup screen, 3-23
print by record, 3-35
print by zone
 form, 3-35
print data, 3-31
 cancel button, 3-37
 print by zone, 3-35
 printer, 3-35
 recipe, 3-36
 sample x of y, 3-37
 select by record, 3-36
 select by zone, 3-36
 select range, 3-36
print data screen, 3-37
print schedule
 automatic printing, 3-24
 English only printing, 3-24
 on alarm, 3-24
 on sample, 3-24
print schedule screen, 3-24
print screen
 differential, 3-23
print setup screen
 cumulative, 3-23
 last calibration, 3-23
 model name, 3-23
 separator, 3-23
 serial number, 3-23
 statistics, 3-23
 statistics only, 3-23

printer, 3-35, A-1
 using, 2-4
printer paper
 colored strip, 3-23
printer port, 2-1

R

recipe, 3-9, 3-39
recipe screen, 3-13
recipes, 3-8
recipes screen
 channels T tab, 3-17
 recipe tab, 3-14
 timing tab, 3-16
 cycles, 3-17
 delay, 3-17
 hold, 3-17
 sample time, 3-17
 volume, 3-17
recipes setup screen, 3-14
 automatic, 3-15
 beep, 3-15
 manual, 3-15
records, 3-31
recs, 3-5
regional
 formats, 3-29
 language, 3-29
regional screen, 3-29
relative humidity, 3-7
 probe, A-2
reports, A-1
reports tab
 air flow, 3-39
 check the recipe, 3-38
 class level, 3-39
 exclude samples button, 3-39
 generate, 3-38, 3-39
 recipe, 3-39
 room area, 3-39
 use end date, 3-39
 use start date, 3-39
returning for service, 7-3
RH, 3-31
RoHS marking, A-3
room area, 3-39

S

safety, vii
sample, 3-17, 3-31
sample output, A-1
sample probe/tubing, A-1
sample time, 3-17
sampling
 frequency, A-1
 modes, A-1
 time, A-1
save, 3-11
save new zone, 3-11
screen alignment, 3-27
screen layout, 3-2
secured file, 3-32

- select by record, 3-34
- select by zone, 3-34
- select range, 3-34
- separator, 3-23
- serial number, 3-23
- serial number label, viii
- service
 - returning, 7-3
- setup tab, 3-8
 - device setup, 3-8
 - environment setup, 3-8
 - information, 3-8
 - recipes, 3-8
 - system setup, 3-8
 - zones setup, 3-8
- size, 3-31
- size range, 1-1, A-1
- size resolution, A-1
- software
 - installation, 4-2
- specifications, A-1
- stainless steel isokinetic inlet, 1-4
- stand, 2-1
 - using, 2-2
- standard, 3-9
- standards, A-2
- standby mode, 2-3, 6-2
- start sample, 2-1
- start/stop buttons, 3-5, 3-7
- statistics, 3-23
- statistics only, 3-23
- status, 3-9
- storage conditions, A-2
- store partial samples, 3-22
- stylus, 1-2, 2-1
 - using, 2-2
- subnet mask, 3-28
- superthane tubing, 1-4
- system error, 6-2
- system setup, 3-8
- system setup screen, 3-19

T

- TCP/IP, 3-28
- technical contacts, 7-1
- temperature, 3-7, 3-31
 - probe, A-2
- temperature/humidity probe, 1-4
 - error, 6-2
 - installation, 2-5
- time, 3-5, 3-26, 3-31
- touch screen, 2-1
- troubleshooting, 6-1

U

- unpacking, 1-2
- unsecured file, 3-32
- USB computer communication, 4-1
- USB port, 2-1
- use dhcp, 3-28
- use end date, 3-33, 3-35, 3-37, 3-39
- use start date, 3-33, 3-35, 3-37, 3-39

V

- vacuum source, A-1
- vol, 3-31
- volume, 3-17

W-X-Y

- warning
 - description, ix
 - symbol, ix
- warranty, iii, A-2
- weight, A-2

Z

- zero check, 5-1
 - maintenance, 5-1
- zero count level, A-1
- zone, 3-5, 3-31
- zone icon, 3-4
- zone setup
 - add zone, 3-10
 - air flow, 3-9
 - area, 3-9
 - class, 3-9
 - delete zone, 3-10
 - edit zone, 3-11
 - locations, 3-9
 - name, 3-9
 - recipe, 3-9
 - standard, 3-9
 - status, 3-9
- zone setup screen, 3-9
- zones setup, 3-8
- zoom, 3-22
- zoomed data screen, 3-7



UNDERSTANDING, ACCELERATED

TSI Incorporated – Visit our website www.tsi.com for more information.

USA	Tel: +1 800 680 1220	India	Tel: +91 80 67877200
UK	Tel: +44 149 4 459200	China	Tel: +86 10 8219 7688
France	Tel: +33 1 41 19 21 99	Singapore	Tel: +65 6595 6388
Germany	Tel: +49 241 523030		

P/N 6004215 Rev. L

©2018 TSI Incorporated

Printed in U.S.A.

