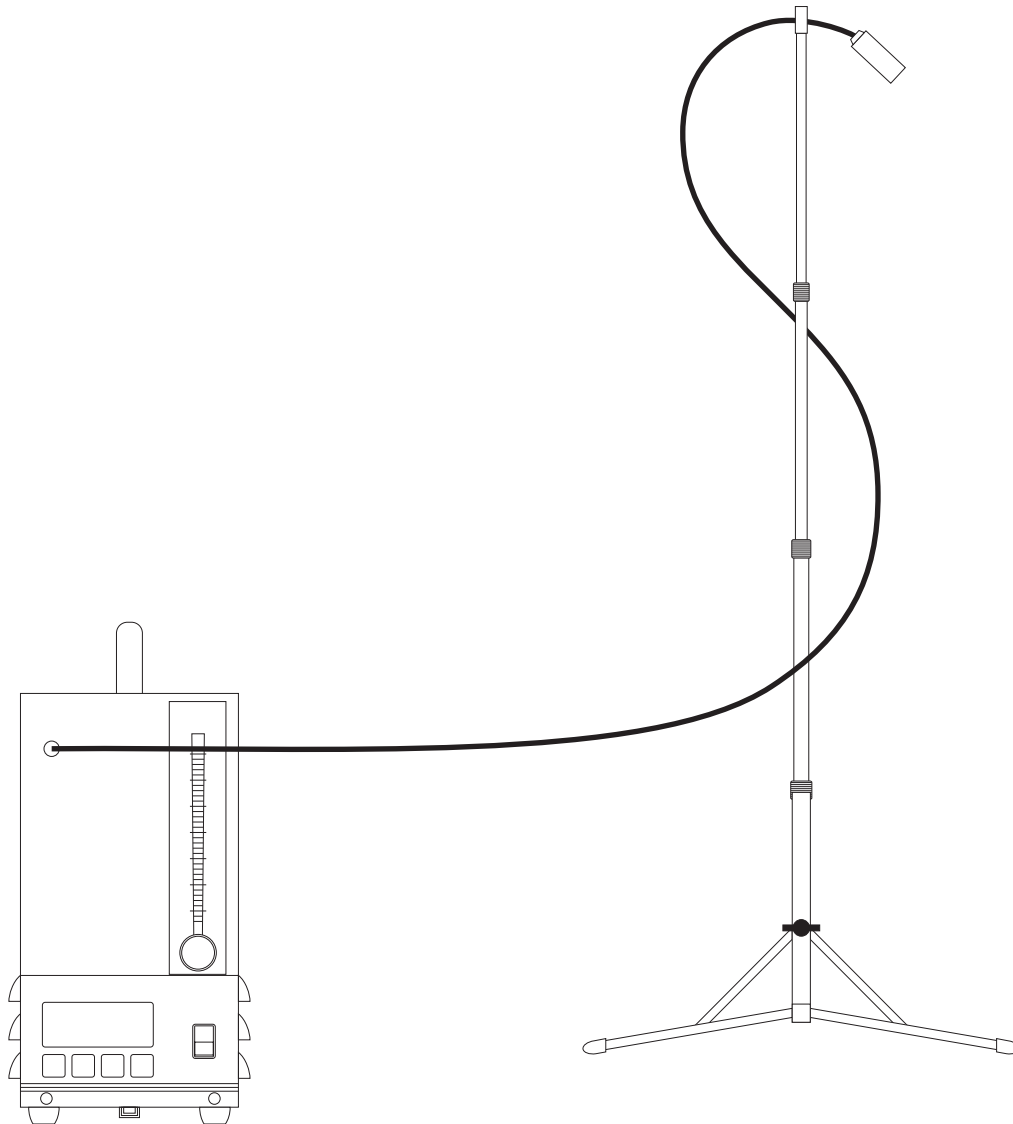


# **Gilian®**

## **AIRCON-2**

# **HIGH VOLUME AIR SAMPLER**

### ***OPERATION & SERVICE MANUAL***



***SENSIDYNE®***

1000 112th Circle N, Suite 100 • St. Petersburg, FL 33716  
(800) 451-9444 • (727) 530-3602 • (727) 539-0550 [FAX] \* [www.sensidyne.com](http://www.sensidyne.com)

***Revision K • Document No. F-PRO-3100***



**PROPRIETARY NOTICE**

This manual was prepared by Sensidyne, LP exclusively for the owner of the AirCon-2 High Volume Air Sampler. The material within this manual is the proprietary information of Sensidyne, LP and is to be used only to understand, operate, and service the instrument. By receiving this document, the recipient agrees that neither this document nor the information disclosed within nor any part shall be reproduced or transferred, physically, electronically or in any form or used or disclosed to others for manufacturing or for any other purpose except as specifically authorized in writing by Sensidyne, LP.

**COPYRIGHT NOTICE**

© 1998-2008, Sensidyne, LP. ALL RIGHTS RESERVED. Information contained in this document is protected by copyright. No part of this document may be photocopied, reproduced, or translated to another program or system without prior written authorization from Sensidyne, LP.

**TRADEMARK NOTICE**

Sensidyne, the Sensidyne logo, Gilian, and the Gilian logo are registered trademarks of Sensidyne, LP. These trademarks are protected through use and registration in the United States. The trademarks and servicemarks used in this document are the property of their respective companies and are used only for informational and explanatory purposes.

**DISCLAIMER**

THE SELLER ASSUMES NO RESPONSIBILITY WHATSOEVER, TO ANY PARTY WHOSOEVER, FOR ANY PROPERTY DAMAGE, PERSONAL INJURY, OR DEATH RECEIVED BY OR RESULTING FROM, IN WHOLE, OR IN PART, THE IMPROPER USE, INSTALLATION, OR STORAGE OF THIS PRODUCT BY THE USER, PERSON, FIRM, ENTITY, CORPORATION OR PARTY NOT ADHERING TO THE INSTRUCTIONS AND WARNINGS IN THIS MANUAL, OR OTHERWISE PROVIDED BY THE SELLER OR FROM NOT ADHERING TO ALL FEDERAL, STATE, AND LOCAL ENVIRONMENTAL AND OCCUPATIONAL HEALTH AND SAFETY LAWS AND REGULATIONS.

THE SELLER SHALL NOT BE LIABLE FOR DIRECT, INDIRECT, CONSEQUENTIAL, INCIDENTAL OR OTHER DAMAGES RESULTING FROM THE SALE AND USE OF ANY GOODS AND SELLERS' LIABILITY HEREUNDER SHALL BE LIMITED TO REPAIR OR REPLACEMENT OF ANY GOODS FOUND DEFECTIVE. THIS WARRANTY IS IN LIEU OF ALL OTHER WARRANTIES, EXPRESSED OR IMPLIED, INCLUDING BUT NOT LIMITED TO THE IMPLIED WARRANTIES OF MERCHANTABILITY AND FITNESS FOR USE OR FOR A PARTICULAR PURPOSE WHICH ARE EXPRESSLY DISCLAIMED.

# TABLE OF CONTENTS

---

## • PREFACE

---

- WARNINGS ..... 7
  - Packing List ..... 8
- 

## SECTION ONE: INTRODUCTION

---

- 1.1 Description ..... 9
  - 1.2 Power Sources ..... 10
    - 1.2.1 AC Power ..... 10
    - 1.2.2 DC Power ..... 10
    - 1.2.3 Power Module ..... 10
  - 1.3 Controls & Indicators ..... 12
    - 1.3.1 On/Off Switch ..... 12
    - 1.3.2 Flow Adjustment ..... 12
    - 1.3.3 LCD Display ..... 12
    - 1.3.4 Touch-Pad Buttons ..... 12
  - 1.4 Standard Parts ..... 12
    - 1.4.1 Telescopic Sampling Mast ..... 12
    - 1.4.2 Air House & Hose Support Tip ..... 12
- 

## SECTION TWO: SET-UP

---

- 2.1 General Set-Up ..... 16
  - 2.1.1 Sampling Mast ..... 16
  - 2.1.2 Air Hose ..... 16
  - 2.1.3 Filter Cassettes ..... 16
- 2.2 Charging ..... 17
  - 2.2.1 Using The DC Unit ..... 17
  - 2.2.2 Charging With The Power module ..... 17

---

## SECTION THREE: OPERATION

---

<b>3.1</b>	<b>Overview</b> .....	21
<b>3.2</b>	<b>Basic Operation</b> .....	21
3.2.1	Single Mode .....	21
3.2.2	Cycle Mode Operation .....	21
<b>3.3</b>	<b>Faults</b> .....	24
3.3.1	Fault Function .....	24
3.3.2	Correcting Fault Conditions .....	24
3.3.3	Low Battery Indication .....	24
<b>3.4</b>	<b>Programming Examples</b> .....	25
3.4.1	Cycle Mode Programming Example .....	25
3.4.2	Other Programming Examples .....	25

---

## SECTION FOUR: AFTER SAMPLING

---

<b>4.1</b>	<b>Unit Shut Down</b> .....	32
<b>4.2</b>	<b>Sampling Mast</b> .....	32
<b>4.3</b>	<b>Battery Pack Maintenance</b> .....	32

# TABLE OF CONTENTS

---

## SECTION FIVE: APPENDICES

---

- **Appendix A: Parts List** .....33
- **Appendix B: Specifications** .....34
- **Appendix C: Returned Material Authorization** .....35
  - Returned Material Authorization .....35
  - Service Options .....35

---

## LIST OF FIGURES

---

- 1.1 AirCon-2 Air Sampler with Sampling Mast & Air Hose ..... 11
- 1.2 Front Panel ..... 13
- 1.3 Liquid Crystal Display ..... 14
- 1.4 AirCon-2 Accessory Configurations ..... 15
  - 2.1 DC Sampler Set-Up ..... 18
  - 2.2 Power Module Set-Up (Single Pack) ..... 19
  - 2.3 Power Module Set-Up (Multiple Packs) ..... 20
- 3.1 Cycle Mode Programming Example ..... 25

---

## LIST OF TABLES

---

- 3.1 Setting Air Flow ..... 22
- 3.2 Single-Mode Operation ..... 23
- 3.3 Pre-Programmed Data ..... 26
- 3.4 Entering Program Mode ..... 27
- 3.5 Delay Time ..... 28
- 3.6 Run Time ..... 29
- 3.7 Hold Time ..... 30
- 3.8 Run Cycles ..... 31



# WARNINGS !



## READ AND UNDERSTAND ALL WARNINGS BEFORE USE

Read and understand **ALL** warnings before using this product. Failure to read, understand, and comply with **ALL** warnings could result in property damage, severe personal injury, or death.

Read and understand **ALL** applicable Federal, State, and Local environmental health and safety laws and regulations, including OSHA. Ensure complete compliance with **ALL** applicable laws and regulations before and during use of this product.

**UNDER NO CIRCUMSTANCES** should this product be used except by qualified, trained, technically competent personnel and not until the warnings, *Operation and Service Manual*, labels, and other literature accompanying this product have been read and understood.

The *Operation and Service Manual must be read and understood by each user before operating this product* or using its accessories, in order to ensure proper and safe use and installation of this product and to ensure familiarity with the proper treatment and safety procedures in the event of an accident.

**Caution:** Risk of electrical shock.

**Warning:** Line cord must be removed to remove all power from equipment.

**DO NOT** remove, cover, or alter any label or tag on this product, its accessories, or related products.

**DO NOT** operate this product should it malfunction or require repair. Operation of a malfunctioning product, or a product requiring repair may result in serious personal injury or death. **DO NOT** attempt to repair or modify the instrument, except as specified in the *Operation and Service Manual*. Contact the Sensidyne Service Department to arrange for a Returned Material Authorization (RMA).

Use **ONLY** genuine Sensidyne<sup>®</sup> replacement parts when performing any maintenance procedures described in this manual. Specifically the DC version of the AirCon-2 is designed for use with AirCon-2 Battery Packs, and should not be used in conjunction with any other equipment. Rechargeable Battery Packs are designed to be charged with the AirCon-2 Power Module and in strict accordance with the charging instructions contained in this manual. *Failure to follow these warnings may seriously impair instrument performance.* Repair or alteration of the product beyond the scope of these maintenance instructions, or by anyone other than a certified Sensidyne<sup>®</sup> serviceman, could cause the product to fail to perform as designed, and persons who rely on this product for their safety could sustain severe personal injury or death.

**DO NOT** operate unit in excessive chemical or water vapor atmospheres. Failure to follow instructions may cause permanent damage to the equipment.

**NEVER** block the cooling air inlets (located at the top/back of unit) when the unit is operating.

**NEVER** block any of the venting holes (located on the sides of the case) when the unit is operating.

**ALWAYS** place the unit on a secure and level surface when operating.

**ALWAYS** operate unit within the intrinsically safe environmental regime specified (non-hazardous locations).

# PACKING LIST

The items listed below are shipped with the **Gilian AirCon-2 High Volume Air Sampler**:

- AirCon-2 DC Air Sampler unit,  
requires a Battery Pack (sold separately)
- Air Hose (Tubing)
- Hose Support Tip
- Sampling Mast
- *Operation and Service Manual*
- Registration Card/Warranty Card

***ALWAYS check to make certain  
you have received all of the items listed above.***

***If you have any questions or need assistance,  
contact your Sales Representative, or call***

**(800) 451-9444**

**OR**

**(727) 530-3602**



## 1.1 DESCRIPTION

### **IMPORTANT**

*You must read this manual in its entirety to ensure proper operation of your unit.*

The AirCon-2 Air Sampling System (PN° 801012) is a powerful environmental air sampler used to collect air samples indoors and outdoors. It is equipped with useful performance features industrial hygienists need most; easy set-up, compact size, Battery Pack operation, programmable timing functions and DC portability. The unit may be operated on AC current when used with the optional Power Module.

The Aircon-2 Air Sampling kit includes main sampling unit, air hose, hose support tip, sampling mast, and manual. The unit requires a 4-hour Battery Pack and/or Power Module for operation (sold separately).

The AirCon-2 high volume air sampling system consists of a positive displacement pump with a unique patented regulator system which maintains flow constant over a flow range of 2-30 LPM. The sampler maintains air flow constant for sampling of airborne particulate, hazardous dust and low concentration pollutants using many popular filter cassettes. The volume of air that passes through the filter cassette is determined by the following:

$$\text{Air flow} \times \text{Elapsed time} = \text{Volume}$$

**For example:**

$$10 \text{ L/min} \times 500 \text{ minutes} = 5000\text{L or } 5\text{M}^3$$

The unit is set up in the required location and operated using a 4-hour Battery Pack and/or to a Power Module which is designed to power the unit from a standard AC source.

The AirCon-2 system provides a telescopic sampling mast which is extended to nose height and to which the air hose/support tip is connected. The media, typically a filter cassette, is inserted into the end of the sampling hose. The other end of the air hose is connected to the "Air Inlet" located at the front of the sampler.

After positioning the unit and setting up the sampling mast stand, the unit can be turned on. Air flow is set by use of the external flow adjust knob and is indicated on the built-in rotameter.

The Aircon-2 is programmable and offers a touch keypad and LCD display which allow the user to program sampling routines. Programmable timing functions include: start and stop times, intermittent run, delay, run/hold and memory storage of up to three custom timing programs. The full-function display and touch pad offer key-in programming and visual monitoring of all timing functions during programming and sampler operation.

---

## 1.2 POWER SOURCES

---

### 1.2.1 AC Power

AC power is provided through the Power Module. A 2-prong Euro plug is provided for 230 VAC operation.

### 1.2.2 DC Power

DC Power is provided by a four-hour Battery Pack. The Battery Packs can be stacked and interconnected to achieve the ampere hour rating required to meet the most stringent sampling conditions. Battery packs are recharged with the optional Power Module.

### 1.2.3 Power Module

The AirCon-2 can be run directly off the Power Module. If the battery module is also attached, it will slowly charge the battery while still providing sufficient power to run the sampler. It will rapidly charge the battery if the sampler is turned off under the same circumstances. The Power Module may also be used as a stand-alone battery charger and may charge one or more batteries.

---

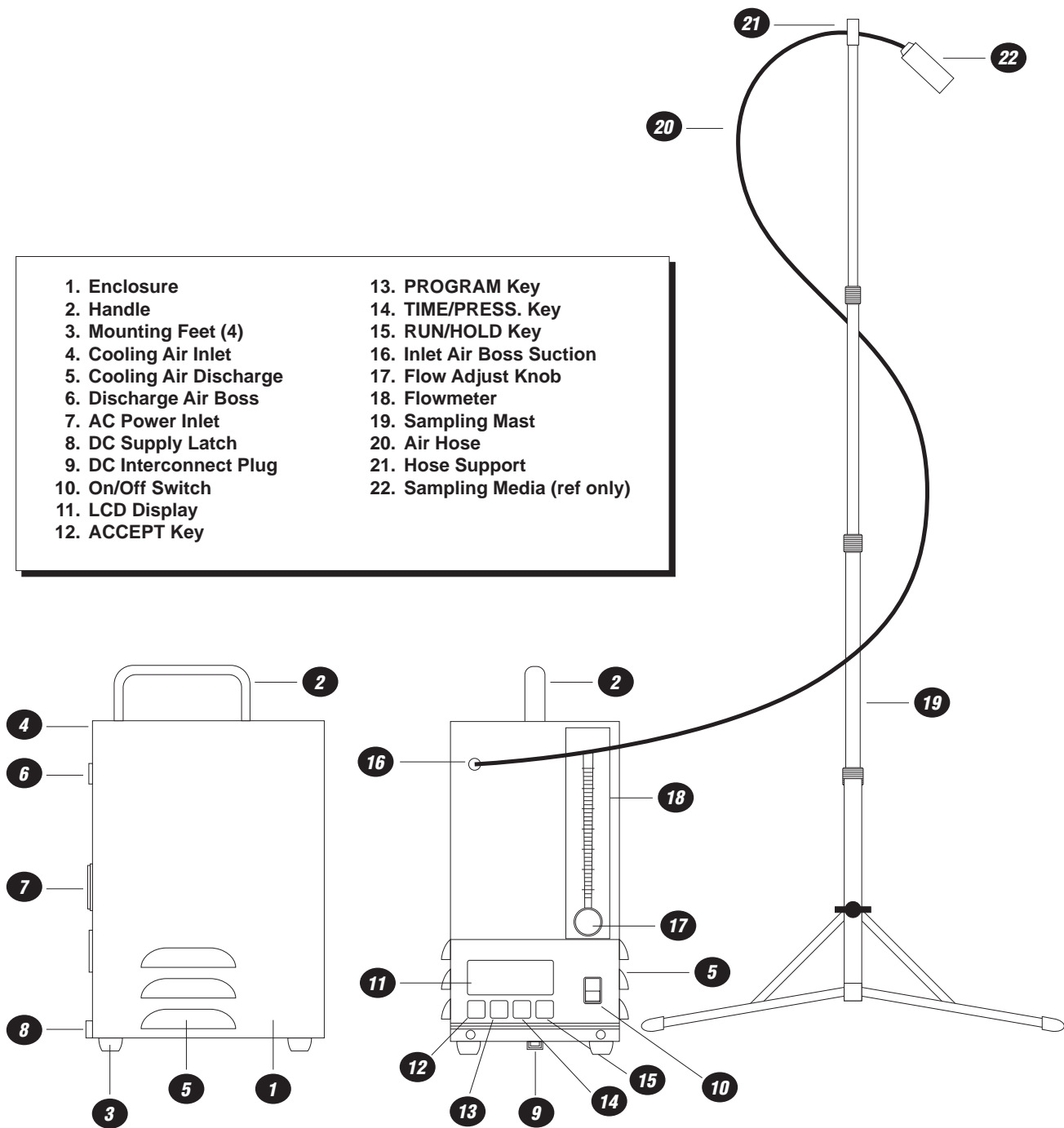
#### **NOTE**

*Stacking batteries on the Power Module will increase the time required for full charge.*

---

The unit will automatically reduce the charging currents as the battery becomes fully charged. An LED indicator illuminates when charging and flashes when charging is complete. If no battery is attached it will flash indicating sufficient voltage to run the sampler. The Power Module can operate on 115–230 VAC, 47–63 Hz.

- |                          |                               |
|--------------------------|-------------------------------|
| 1. Enclosure             | 13. PROGRAM Key               |
| 2. Handle                | 14. TIME/PRESS. Key           |
| 3. Mounting Feet (4)     | 15. RUN/HOLD Key              |
| 4. Cooling Air Inlet     | 16. Inlet Air Boss Suction    |
| 5. Cooling Air Discharge | 17. Flow Adjust Knob          |
| 6. Discharge Air Boss    | 18. Flowmeter                 |
| 7. AC Power Inlet        | 19. Sampling Mast             |
| 8. DC Supply Latch       | 20. Air Hose                  |
| 9. DC Interconnect Plug  | 21. Hose Support              |
| 10. On/Off Switch        | 22. Sampling Media (ref only) |
| 11. LCD Display          |                               |
| 12. ACCEPT Key           |                               |



**Figure 1.1**  
**AirCon-2 Air Sampler with Sampling Mast & Air Hose**

## 1.3 CONTROLS & INDICATORS

### 1.3.1 On/Off Switch

The power is activated by a rocker switch located to the right of the key pad. The removable electrical cord provided is attached at the back of the Power Module.

---

#### **CAUTION**

*Line cord must be removed to remove all power from equipment.*

---

### 1.3.2 Flow Adjustment

The patented flow controller system consists of the *flow control regulator* located in the base of the pump, and the *flow control system* which consists of the flow adjust valve and rotameter located on the front of the sampler.

### 1.3.3 LCD Display

A large easy-to-read display is included on the AirCon-2 (see Figures 1.2 & 1.3). The display includes direct digital readings, as well as a variety of messages pertaining to the operation and programming of the unit.

### 1.3.4 Touch-Pad Buttons

The Touch-Pad buttons are explained as follows:

#### **ACCEPT**

This is used to switch the unit into the preprogrammed cycle modes or as confirmation (in programming mode) to accept data into memory.

#### **PROG (Program)**

This button is used to enter programming mode and to set or change program data.

#### **TIME/PRESS. (Pressure)**

Pressing this button toggles the display between Time and Pressures readings. These readings can be viewed any time while the unit is running.

#### **RUN/HOLD**

Pressing this button switches the pump operation between Run and Hold functions.

## 1.4 STANDARD PARTS

### 1.4.1 Telescopic Sampling Mast

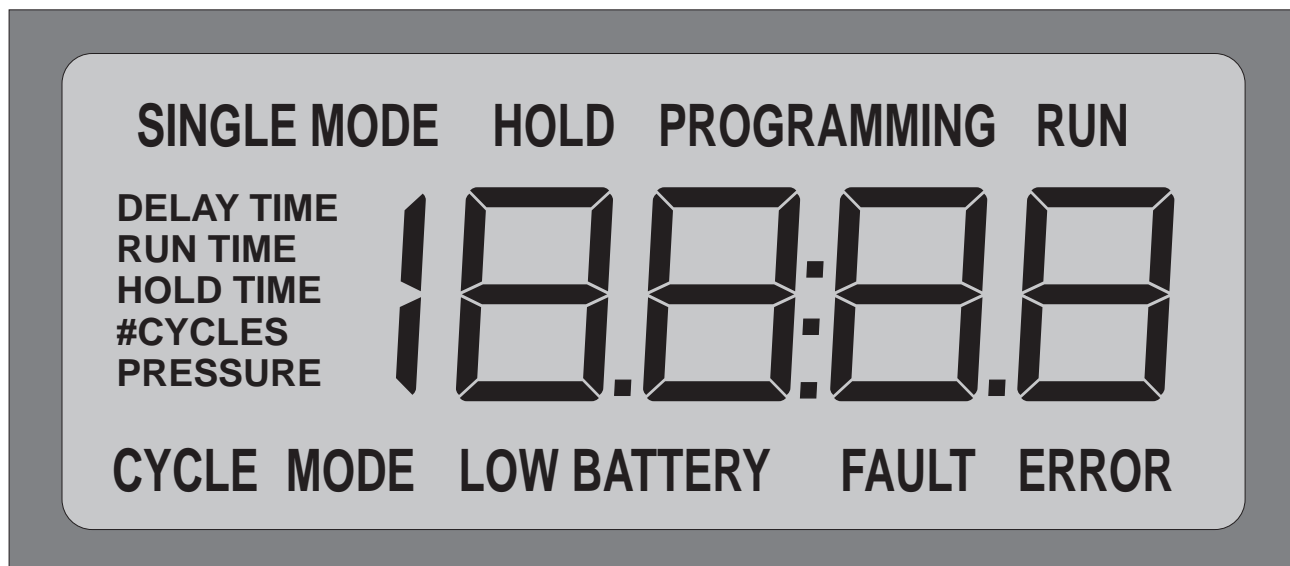
The telescopic sampling mast is provided as an independent stand to isolate the filter cassette from the unit insuring vibration-free sampling. The mast can be extended to achieve any height up to approximately 5 feet and collapses for convenient storage.

### 1.4.2 Air Hose & Hose Support Tip

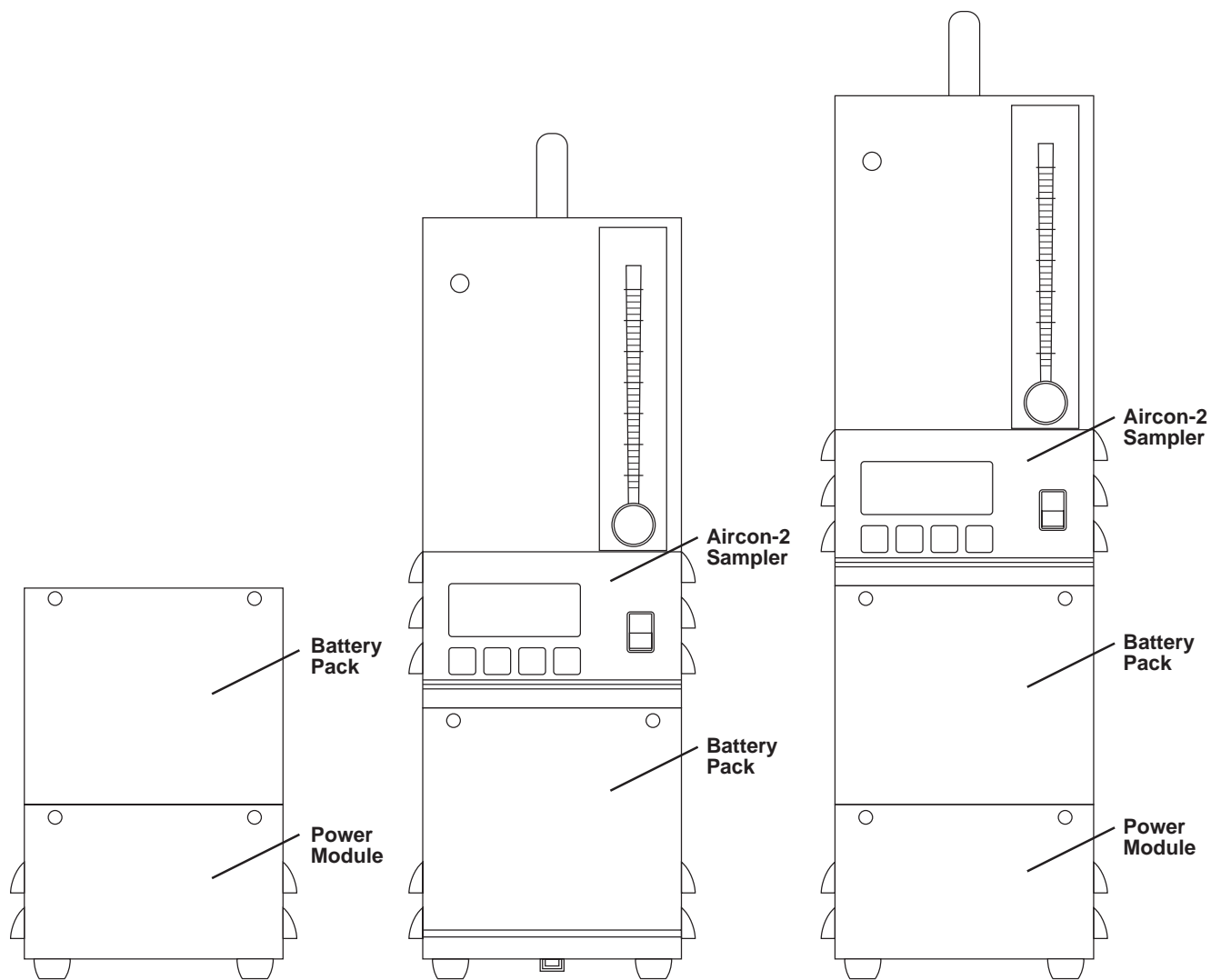
Approximately 6 feet of hosing is supplied with the unit. One end is connected to the Inlet Air Boss Suction port on the sampler and threaded through the Hose Support Tip which is mounted on the sampling mast. A filter cassette is then attached to the other end of the air hose.



**Figure 1.2**  
**Front Panel**



**Figure 1.3**  
**Liquid Crystal Display**



4-Hour Battery Pack mounted on the Power Module for charging.

DC Sampler mounted onto a 4-Hour Battery Pack.

DC Sampler and 4-Hour Battery Pack mounted on the Power Module for operation in AC or DC environments.

**Figure 1.4**  
**AirCon-2 Accessory Configurations**

# SECTION TWO

## SET-UP

### 2.1 GENERAL SET-UP

Place the unit in the desired sampling area. Make certain the unit is standing in a vertical position.

#### **NOTE**

*When using rotameters, it is important to maintain a vertical position for optimum accuracy. The rotameter provided in this sampler has been tested for accuracy and is within  $\pm 5\%$  of full scale.*

#### 2.1.1 Sampling Mast

To set up the Sampling Mast, perform the following steps:

- 1) First, unfold the legs at the bottom of the mast stand by opening the locking knob and pulling the legs outwards as far as they will extend.
- 2) Loosen the largest locking collar at the bottom of the stand and pull out by the second largest locking collar. Tighten the largest collar.
- 3) Holding the extended section, loosen the second largest locking collar and extend the next section of the mast. Tighten the second largest collar.
- 4) Repeat this procedure until the mast is extended to its full or required height.
- 5) Be sure to tighten each locking collar before proceeding to loosen the next. Position the extended mast next to sampler.

#### 2.1.2 Air Hose

To attach the Air Hose, perform the following steps:

- 1) Connect one end of the flexible tubing to the air inlet valve located at the back of the sampler.
- 2) Connect the hose support tip to the top of the extended sampling mast.
- 3) Insert tubing through the hose support tip, with 2–3" of the hosing extending out.
- 4) Insert filter cassette or other media into air hose end.

#### 2.1.3 Filter Cassettes

To install the Filter Cassette, do the following:

- 1) First, remove any cap plugs from the filter cassette. These may be colored in red and blue. Also remove the end of the filter cassette to expose the filter, if the test method requires it (e.g., asbestos sampling). This is called "open-face" filter sampling. This allows air to enter the cassette freely with minimal back pressure.
- 2) Plug the filter cassette into the end of the sampling hose.



---

## 2.2 CHARGING

---

### 2.2.1 Using The DC Unit

#### Connecting the DC Unit

- 1) Place the Battery Pack or Power Module on a flat surface, orienting the guide pins either to the left or right.
- 2) Tilt the sampler approximately 10°, as shown in Figure 2.1, and engage the female guide-pin receptacle into the guide pins of the Battery Pack or Power Module. Rotate the unit around the guide pins such that the back lip of the Battery Pack or Power Module slides over the recess on the back bottom of the sampler.

---

#### NOTE

*Once the guide pins are aligned and seated, the electrical connector on the sampler and Battery Pack (or Power Module) will connect automatically.*

---

- 3) Pull the latch on the rear of the Battery Pack (or Power Module) over the latch keeper on the back of the sampler, pushing down on the latch to secure it.
- 4) Repeat this procedure for any additional Battery Packs and/or Power Modules.

#### Disconnecting the DC Unit

- 1) Disengage the latch hook.
- 2) Rotate the sampler about guide pin until the back of the sampler disengages the Battery Pack or Power Module.
- 3) Disengage the female receptacle and guide pins of the sampler from the Battery Pack or Power Module respectively.

### 2.2.2 Charging With The Power Module

The Power Module may be plugged into any line voltage from 115 to 230 VAC, 50/60 Hz without any switch adjustments.

To charge the Battery Pack independently:

- 1) Connect the Battery Pack to the Power Module (refer to Figure 2.2). Multiple Battery Packs may be connected to the Power Module (refer to Figure 2.3).

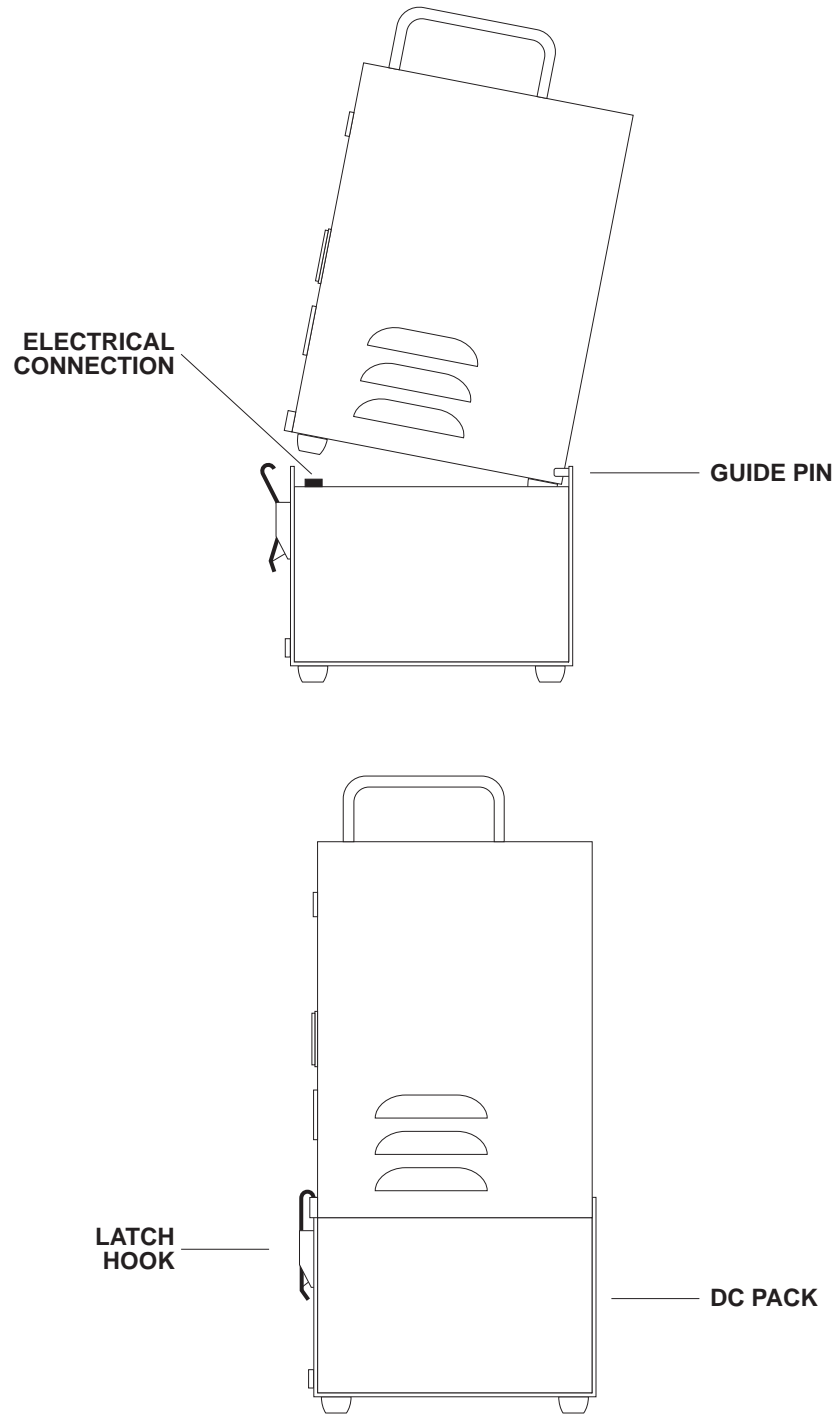
---

#### NOTE

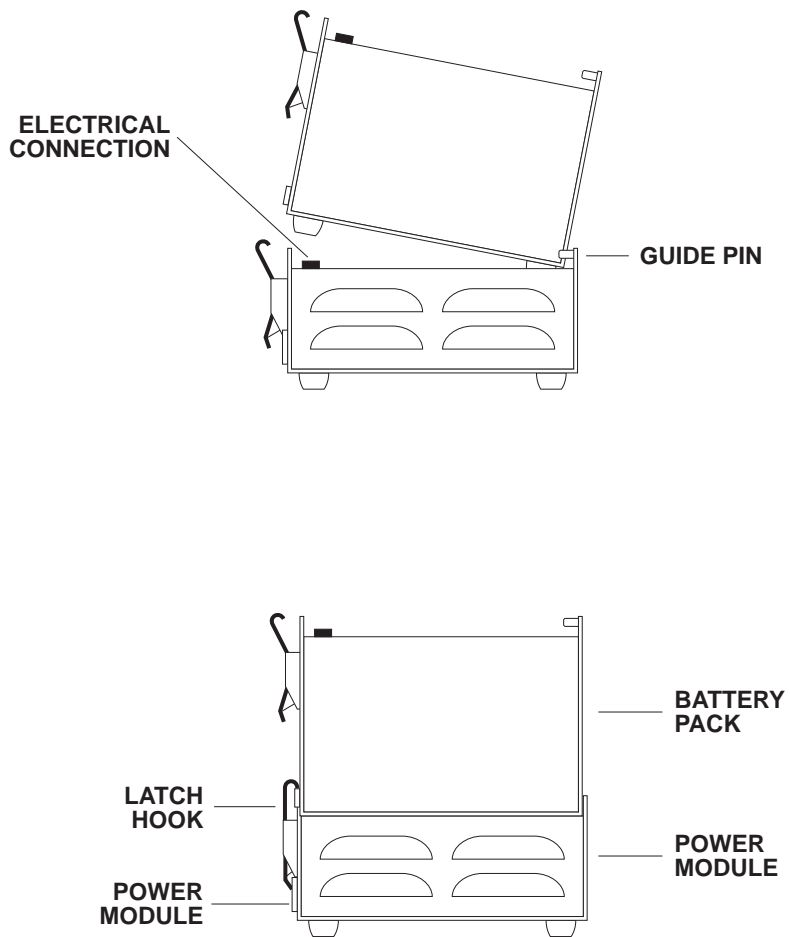
*Charging multiple Battery Packs will increase the required charging time.*

---

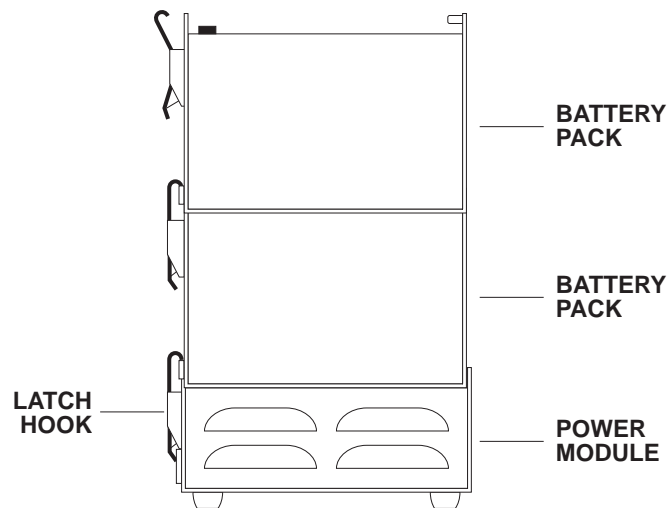
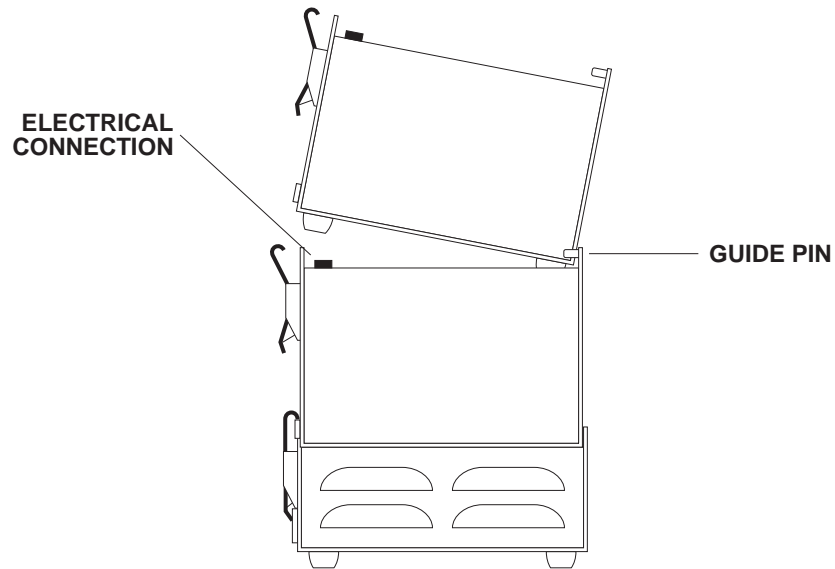
- 2) Attach the line cord to the receptacle located at the back of the Power Module.
- 3) Plug the line cord into the AC receptacle.
- 4) An LED, located on the back of the Power Module will light, indicating whether there is sufficient DC voltage available to the sampler. If a Battery Pack is attached and is not fully charged, the LED will remain illuminated until the battery is charged. When fully charged, the LED will start to pulse. If no battery is attached, the unit will pulse.



**Figure 2.1**  
**DC Sampler Set-Up**



**Figure 2.2**  
**Power Module Set-Up (Single Pack)**



**Figure 2.3**  
**Power Module Set-Up (Multiple Packs)**

## 3.1 OVERVIEW

This section covers the operation of the AirCon-2. Basic operating procedures are described in Section 3.2. Fault conditions are described in Section 3.3. Section 3.4 provides detailed information on how to program the unit.

### OPERATION NOTE

*The rotameter provided has been tested for accuracy and is within  $\pm 5\%$  of full scale. However, the rotameter should be periodically checked against a primary standard, such as the Gilibrator. Be sure to maintain the sampler in a vertical position to ensure accurate operation of the rotameter.*

The unit offers versatile programming, suction pressure load indication, and an instant fault function when the flow deviates by more than  $\pm 5\%$ .

In situations where the 5% envelope is violated for more than 30 seconds, the unit stops sampling and freezes the sample time display, allowing for proper flow rate/volume calculation.

The AirCon-2 has a unique modular Battery Pack/Power Module operating system. The sampler also features a unique hold function. When a fault occurs, the hold function keeps the display visible so long as adequate battery power is available. If the battery level drops further, the display is erased. However, the unit stores the "lost" data in internal memory for later recovery. When the unit is connected to a fresh Battery Pack and turned on, the previous run-time data are re-displayed on the screen.

## 3.2 BASIC OPERATION


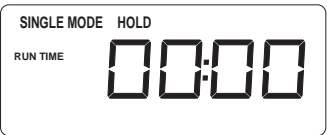


### 3.2.1 Single Mode

Single-Mode operation provides complete manual control of sampling (refer to Tables 3.1 & 3.2 for details). The unit is turned on, the flow is set, and the ACCEPT button is pressed. This enters the flow fault information into the on-board computer. Pressing Run starts the sampler. The sampler continues to run until the Hold button is pressed, or the unit is turned off. You can use the Run/Hold and Time/Press buttons at any time while the unit is sampling.

Single-Mode operation provides complete manual control of sampling. The unit is turned on, the air flow is set, and the ACCEPT button is pressed. This enters the flow fault information into the on-board computer. Pressing Run starts sampling. Sampling continues until the Hold button is pressed, or the unit is turned off. You can use the Run/Hold and Time/Press buttons at any time while the unit is sampling. Tables 3.1 and 3.2 provide step-by-step instructions for performing Single-Mode sampling.

### 3.2.2 Cycle Mode Operation

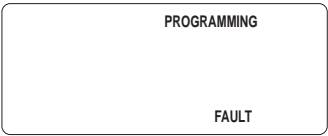
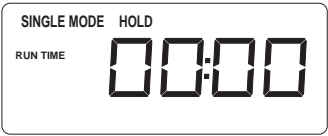

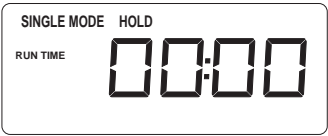

Cycle mode runs the sampler from previously created programs. An example of cycle mode programming is shown in Section 3.4.

Step	Switch/Button	Action	Display Example
1	ON/OFF	Switch power to the ON position. Display shows PROGRAMMING/FAULT	
2	FLOW ADJ. KNOB	Set the air flow rate by turning counter-clockwise to increase, or clockwise to decrease. Flow rate is shown on the flowmeter.	
3	ACCEPT	Press to enter the flow rate fault limits into memory. The pump will stop and the display will read SINGLE MODE/ HOLD.	
4	Option 1: RUN	At this time, you may press RUN to start sampling. The sampler will run continuously until you shut it off.	
5	Option 2: PROG ACCEPT	Run the sampler from pre-programmed data. Press PROG to enter programming mode. Select the program no. (1–3) by pressing PROG additional times.	
6	Note:	If you are unfamiliar with programming data, review all programming tables in succession.	

**Note**

Once set, do not adjust the air flow during operation. This can cause a fault to occur. Always turn the unit off and back on again. Then, follow the steps above to reset the flow.

**Table 3.1  
Setting Air Flow**

Step	Switch/Button	Action	Display Example
1	ON/OFF	Switch power to the ON position. Display shows PROGRAMMING/FAULT	
2	FLOW ADJ. KNOB	Set the air flow rate by turning counter-clockwise to increase, or clockwise to decrease. Flow is indicated on the flowmeter.	
3	ACCEPT	Press to enter the flow rate fault limits into memory. The pump will stop and display will read SINGLE MODE/ HOLD.	
4		Unit is in Single Mode Hold. To run sampler continuously without timing program continue to step 5.	
5	RUN	Press to take unit out of Hold Mode and put into Run Mode. Motor turns ON, internal clock begins counting in real time. Sampler runs until it is shut off. Display indicates SINGLE MODE/ RUN.	
6	HOLD	Press to take unit out of Run Mode and put into Hold Mode. Motor turns OFF, clock stops counting, colon stops flashing. Display indicates SINGLE MODE/ HOLD.	
7	TIME/PRESS	Press at any time during RUN operation to view current Run Time or Back Pressure readings.	



**Table 3.2**  
**Single-Mode Operation**

### 3.3 FAULTS

#### 3.3.1 Fault Function

When the pressure in the bypass path differs more than  $\pm 5\%$  from the value that was stored initially during flow adjust set-up, the display will show FAULT for approximately 25 seconds.

If a fault condition still exists, the following occurs:

- 1) The motor will turn off.
- 2) The display will show the collected Run Time to fault shutdown.
- 3) FAULT will flash on the display.

#### 3.3.2 Correcting Fault Conditions

- 1) Turn the power switch to the OFF position.
- 2) Turn it back to the ON position. This resets the system, clearing the fault.
- 3) At this time, you should:
  - a) Check the filter cassette for excessive buildup.
  - b) Check the air hose for any obstructions or kinks.
  - c) Re-select a program number 1-3 (refer to Table 3.4 for details).

#### 3.3.3 Low Battery Indication

When a DC Battery Pack is running out of charge, the AirCon-2 indicates this condition on the display as LOW BATTERY and the motor stops running. The display remains on until all power is gone. The AirCon-2 stores the collected run time data in memory for safekeeping when shutdown occurs. A new Battery Pack must be connected to access the RUN TIME of the sample. To restart the sampler and access the stored sampling data, do the following:

- 1) Turn the power OFF and remove the used Battery Pack from the sampler.
- 2) Replace with a fully charged Battery Pack.
- 3) Turn the power switch ON. At this time, the motor is not running. The display indicates RUN TIME information.
- 4) To clear the low battery fault condition, press ACCEPT. At this time, the motor will begin running. You can now go into single mode operation, use preprogrammed data, or enter your own programming parameters.



### 3.4 PROGRAMMING EXAMPLES

#### 3.4.1 Cycle Mode Programming Example

A cycle mode programming example is presented below (Figure 3.1) in both tabular and graphic forms. The unit has been programmed to start in DELAY mode. When in DELAY mode, the display counts down the time remaining in the delay period. When the countdown reaches zero, the RUN phase begins. The time shown on the display during the run phase represents the *actual elapsed time since the program was started*, and not the programmed run time (i.e., 16:47).

After the first RUN phase has been completed, the unit goes into its first HOLD phase. While in the HOLD phase, the display counts down the time remaining in the hold period. When the countdown reaches zero, the second RUN phase begins. The time shown on the display during the second RUN phase represents the total accumulated run time since the program started.

After the second RUN phase has been completed, the unit goes into its second HOLD phase. While in the HOLD phase, the display counts down the time remaining in the hold period. When the countdown reaches zero, the third (and final) RUN phase begins. The time shown on the display during the third RUN phase represents the total accumulated run time since the program started. When the third RUN phase is completed, the program concludes and the unit goes into a HOLD phase without countdown.

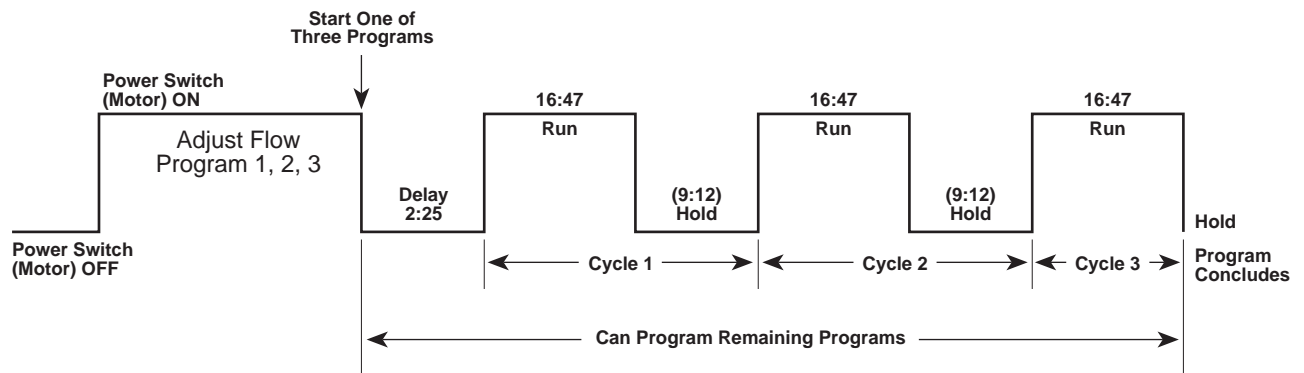
#### 3.4.2 Other Programming Examples

The tables on the following pages (Table 3.3–3.9) show some of the basic operations available with the AirCon-2.

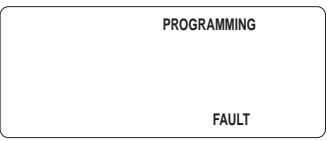
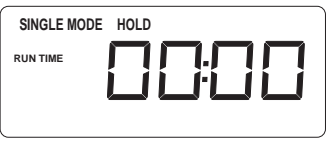
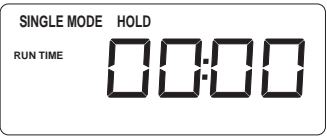
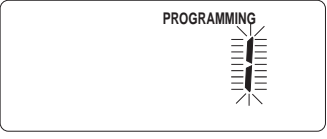


These examples should be read in sequence. Examples of displays at each programming step are provided as visual aids. When you are familiar with the programming procedures, you can enter your own programming parameters.

Sequence	Hours	Minutes
DELAY TIME	2	25
RUN TIME	16	47
HOLD TIME	9	12
# CYCLES	3	

# CYCLES x RUN TIME (3 x 16:47) = 50:35 (Total Collected RunTime)



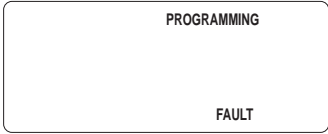
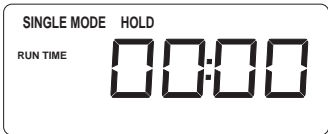

**Figure 3.1**  
**Cycle Mode Programming Example**

Step	Switch/Button	Action	Display Example
1	ON/OFF	Switch power to the ON position. Display shows PROGRAMMING/ FAULT	
2	FLOW ADJ. KNOB	Set the air flow rate by turning counter-clockwise to increase, or clockwise to decrease. Flow is indicated on the flowmeter.	
3	ACCEPT	Press to enter the flow rate fault limits into memory. The pump will stop, and display will read SINGLE MODE/ HOLD	
4		Unit is in SINGLE MODE/ Hold. To run sampler continuously without timing program, continue to step 5.	
5	ACCEPT	Press to execute pre-programmed data.	
6	PROG	Press to enter into Programming Mode. This prepares unit to run the program number shown on the LCD display. Select program number 1, 2, or 3.	
7	ACCEPT	Press to run selected program number. Unit will automatically switch to cycle mode and run pre-programmed data. When in DELAY the unit is Off, and the display counts down the time remaining until start-up.	
8	TIME/PRESS	Press this button at any time during RUN operation to view current the Run Time or Back Pressure readings. Display toggles between the readings.	

**Note**

If you have not previously entered program data, review the steps in Table 3.4.

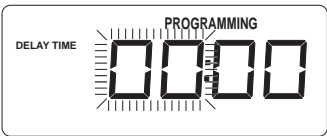


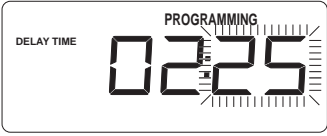
**Table 3.3  
Preprogrammed Data**

Step	Switch/Button	Action	Display Example
1	ON/OFF	Switch to ON"position	
2	FLOW ADJ. KNOB	Set the air flow rate by turning counter-clockwise to increase, or clockwise to decrease. Flow rate is shown on the flowmeter.	
3	ACCEPT	Press to turn motor OFF. Puts the unit in HOLD mode	
4	PROG	Press to put unit in Program Mode. Additional presses select program number 1, 2, or 3. You must select a program number at this time before continuing.	
5	ACCEPT	Press to lock in program number and advance to DELAY TIME set-up.	

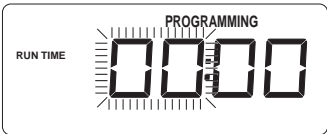
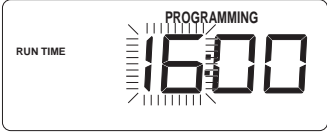
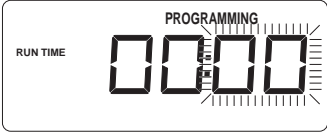

**Note (Step 4):**

If you already have a program stored in “1”, press PROG again to select Program No. 2. There are a total of 3 possible programs that can be stored in memory at one time. If you select a program number that is already running, a PROGRAMMING ERROR message is displayed for 5 seconds. You must select another program number.

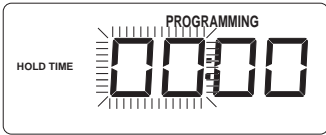

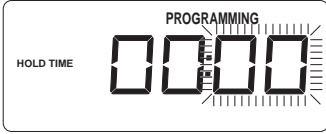

**Table 3.4**  
**Entering program mode**

Step	Switch/Button	Action	Display Example
1		Begin set-up for DELAY TIME /Hours. Hour position is flashing.	
2		To continue DELAY TIME set-up, continue to step 3. If you do not wish to enter DELAY TIME set-up, press ACCEPT twice to advance to RUN TIME set-up.	
3	PROG	Press and hold until hour increment (00-99) is reached.	
4	ACCEPT	Press to lock in DELAY TIME/ Hours and advance to set-up for DELAY TIME/Minutes.	
5		Begin set-up for DELAY TIME /Minutes. Minute position is flashing.	
6	PROG	Press and hold until hour increment (00-59) is reached.	
7	ACCEPT	Press to lock in DELAY TIME /Minutes and advance to set-up for HOLD TIME.	

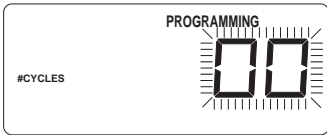
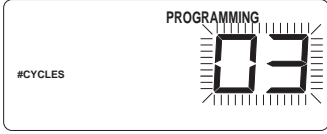
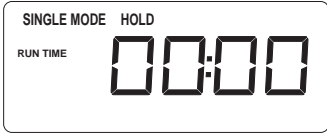
**Table 3.5**  
**Delay Time**

Step	Switch/Button	Action	Display Example
1		Begin set-up for RUN TIME/ Hours. Hour position is flashing.	
2	PROG	Press and hold until hour increment (00-99) is reached. You must enter a value greater than zero for unit to operate.	
3	ACCEPT	Press to lock in RUN TIME/ Hours and advance to set-up for RUN TIME/ Minutes.	
4		Begin set-up for RUN TIME/ Minutes. Minute position is flashing.	
5	PROG	Press and hold until hour increment (00-59) is reached.	
6	ACCEPT	Press to lock in RUN TIME/ Minutes and advance to set-up for Hold Time.	

**Table 3.6**  
**Run Time**

Step	Switch/Button	Action	Display Example
1		Begin set-up for HOLD TIME/ Hours. Hour position is flashing.	
2		If you do not want to enter HOLD TIME data, press ACCEPT twice to advance display to #RUN CYCLES, or continue to step 3.	
3	PROG	Press and hold until hour increment (00-99) is reached.	
4	ACCEPT	Press to lock in HOLD TIME/ Hours and advance to set-up for HOLD TIME/ Minutes	
5		Begin set-up for HOLD TIME/ Minutes. Minute position is flashing.	
6	PROG	Press and hold until minute increment (00-59) is reached.	
7	ACCEPT	Press to lock in HOLD TIME/ Minutes and advance to set-up for # RUN CYCLES.	

**Table 3.7**  
**Hold Time**

Step	Switch/Button	Action	Display Example
1		Begin set-up for RUN CYCLES. Run Cycles position is flashing.	
2*	PROG	Press and hold until the number of cycles (00-99) is reached. You must select a minimum of 1 cycle for the sampler to run.	
3**	ACCEPT	Press to lock in RUN CYCLES. Puts unit in SINGLE MODE/HOLD.	
4		Programming complete for Program No. 1.	

**\* NOTE (Step 2)**

If you do not select a minimum of 1 cycle and enter ACCEPT, the unit will display a PROGRAMMING ERROR message and return you to SELECT PROGRAM NUMBER. You will have to forward through the time menus to # RUN CYCLES to re-enter your selection.

**\*\* NOTE (Step 3)**

The collected RUN TIME (total time) equals the number of cycles times the programmed run time. The total time cannot exceed 199:59 (hours:minutes). When you press ACCEPT, the unit automatically checks the collected run time to see if it exceeds this limit. If it does, a PROGRAMMING ERROR message appears on the display for 5 seconds. If this occurs, you must change the program RUN TIME and/or the # RUN CYCLES be within the total time limit.

**Table 3.8  
Run Cycles**

## **SECTION FOUR**

# **AFTER SAMPLING**

---

### **4.1 UNIT SHUTDOWN**

---

- 1) Turn the power "Off".
- 2) If sampling through the Power Module from an AC source, remove the plug from AC wall outlet and rewind cord.
- 3) Remove the filter cassette or media carefully and label for safe record keeping.
- 4) Disconnect tubing from the sampler's air inlet. Remove connection tip from the top of the sampling mast. Recoil tubing for future use.

---

### **4.2 SAMPLING MAST**

---

- 1) To collapse the sampling mast, start with the smallest locking collar. Loosen the collar and push in the extension. Tighten the smallest collar. Continue with this procedure all the way down the mast until the mast is collapsed.
- 2) Unlock the locking knob at the bottom of the mast stand and fold in the legs until they are parallel with the mast. The mast is now collapsed and ready for storage.

---

### **4.3 BATTERY PACK MAINTENANCE**

---

The AirCon-2 Battery Pack is capable of four hours of DC operation with full charge. Prior to use, the Battery Pack will require full charging to obtain a four hour sampling period. Recharge Battery Pack(s) with the AirCon-2 Power Module accessory.



# APPENDIX A PARTS LIST

Part Number	Item/Description
801001	Four-Hour Battery Pack
801000-2	Power Module Charger CE (Domestic)
801000-3	Power Module Charger CE (European)
401036	Sampling Mast
202046-72	Air Hose (Tubing)
200457	Hose Support Tip
401562	AC Line Cord (Domestic)
700707	AC Line Cord (European)
801171-1	Roller Case

# APPENDIX B SPECIFICATIONS

## General Specifications

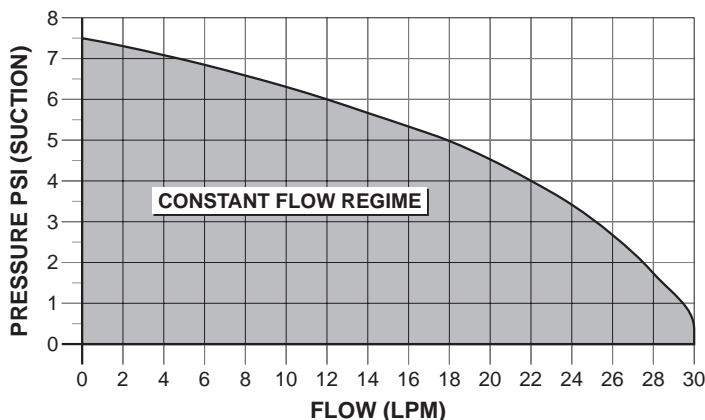
DC Operation .....	Input: 12 Vdc @ 3.4 A. 4-hour rechargeable Battery Pack.
Program Features .....	LCD Display & Touchpad • Electronic Pressure Display • Full-Function Timing Program • Instant-Fault Function • Programmable Memory (up to 3 custom programs).
Other Features .....	External Rotameter & Flow Adjust • Independent Sampling Mast • Instant Fault Function • Low Battery Function.
Dimensions .....	4.3" (W) x 10.3" (H) x 7.5" (D) 108 mm (W) x 260 mm (H) x 191 mm (D)
Weight .....	Main Unit: 12 lbs (5.4 kg) 4-Hour Battery Pack: 11.5 lbs (5.2 kg) Power Module: 2 lbs (0.9 kg)

## Accessories

Power Module .....	Input: 115–230 VAC @ 800/600 mA, 47–63 Hz. Output: 15 Vdc @ 4.3 A. Size: 5.25 (W) x 7.5 (D) x 3.0 (H)
Fuse .....	125 VAC, 6 amp, fast acting
4-Hour Battery Pack .....	12 Vdc, 13 AH. Size: 5.25" (W) x 7.5" (D) x 5.0" (H).

## Operating Specifications

Air Flow Range .....	2–30 LPM
Constant Flow Capabilities .....	2–30 LPM @ pressure up to 7 psi
Operating Temperature .....	-20° to 45°C (-4°F to 113°F)
Storage Temperature .....	-40° to 45°C (-40°F to 113°F)
Humidity .....	0–95 %RH
Pressure Range .....	(see Chart, below)



NOTE: Typical performance curve, to be used for reference only.

# APPENDIX C RETURNED MATERIAL AUTHORIZATION

Sensidyne maintains an instrument service facility at the factory to provide its customers with both warranty and non-warranty repair service. Sensidyne assumes no liability for service performed by personnel other than Sensidyne personnel. To facilitate the repair process, please contact the Sensidyne Service Department in advance for assistance with a problem which cannot be remedied and/or requires the return of the product to the factory. All returned products require a Returned Material Authorization (RMA) number. Sensidyne Service Department personnel may be reached at:

**Sensidyne**  
**1000 112th Circle N, Suite 100**  
**St. Petersburg, FL 33716 USA**  
**727-530-3602**  
**727-539-0550 [FAX]**

All non-warranty repair orders will have a minimum fee whether the repair is authorized or not. This fee includes handling, administration and technical expenses for inspecting the instrument and providing an estimate. However, the estimate fee is waived if the repair is authorized.

If you wish to set a limit to the authorized repair cost, state a "not to exceed" figure on your purchase order. Please indicate if a price quotation is required before authorization of the repair cost, understanding that this invokes extra cost and handling delay.

Sensidyne's repair policy is to perform all needed repairs to restore the instrument to its full operating condition.

Repairs are handled on a "first in - first out" basis. Your order may be expedited if you authorize an expediting fee. This will place your order next in line behind orders currently in process.

Pack the instrument and its accessories (preferably in their original packing) and enclose your return address, purchase order, shipping and billing information, RMA number, a description of the problem encountered with your instrument and any special instructions. All prices are subject to change without notice.

If this is the first time you are dealing directly with the factory, you will be asked to prepay or to authorize a COD shipment.

Send the instrument, prepaid, to:

**SENSIDYNE**  
**1000 112th CIRCLE N, SUITE 100**  
**ST. PETERSBURG, FL 33716 USA**

**ATTENTION: Service Department**

**RMA #:** \_\_\_\_\_

## SERVICE OPTIONS

The Sensidyne Service Department offers you a variety of service options which will help increase your user confidence while minimizing costly interruptions and maintenance costs. These options include initial training, on-site technical assistance, and full factory repairs. Sensidyne has developed several programs which will allow you to select just the right options best suited to your applications and needs. For further information, contact the Sensidyne Service Department.

***SENSIDYNE***<sup>®</sup>

1000 112th Circle N, Suite 100 • St. Petersburg, FL 33716  
800-451-9444 • 727-530-3602 • fax: 727-539-0550  
web: [www.sensidyne.com](http://www.sensidyne.com) • e-mail: [info@sensidyne.com](mailto:info@sensidyne.com)

---

**Revision K • Document No. F-PRO-3100**