

















CAUTION / INFORMATION

	Make sure no obstacles are in the desk's path. Make sure the desktop is not touching any walls. Make sure all cords are appropriate length to accommodate the change in height.			WARNING Pinch Point Keep hands and fingers clear.
	Keep children away from electric height-adjustable desks, control units and handsets. There is a risk of injury and electric shock.			
	Keep all electrical components away from liquids.			
	Do not sit or stand on the desk frame. Do not crawl or lie under the desk frame.			
	Do not place any objects taller than 20" underneath the desk.			
	Do not open any of the components - the Legs, Control Box, or Switch. There is a danger of electric shock.			
	This product is designed with a duty cycle of 10% (2 min. on, 18 min. off).			
	In the event of a power outage or if the power cord is unplugged, a manual reset may be necessary - see Step 12.			

USE / LIABILITY

This height adjustable desk has electric motors and is designed for use in dry work areas only. The desk height is adjustable so that it can be positioned at the most ergonomically suitable height. Any other use is at user's risk.

Under no circumstances does the manufacturer accept warranty claims or liability claims for damages caused from improper use or handling of the desk frame.

IMPORTANT:
Please read this manual carefully.
If this desk is sold, please provide this manual to the buyer.

PARTS

TOOLS REQUIRED

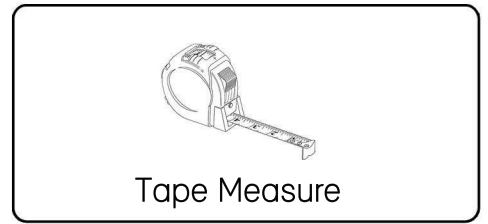
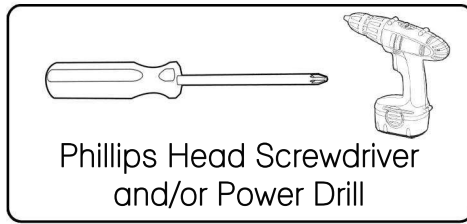
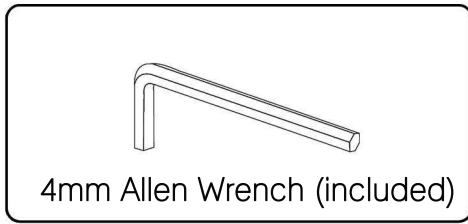

COMPONENTS

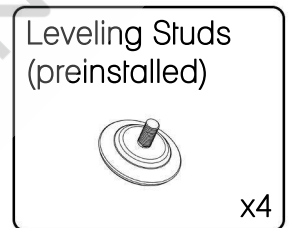
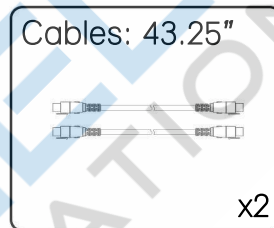
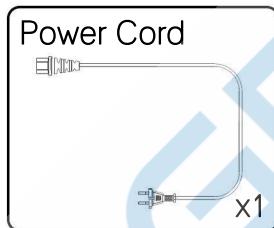
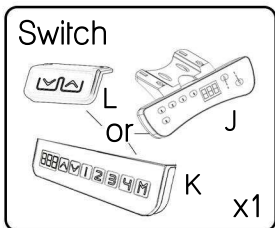
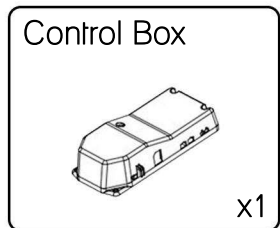
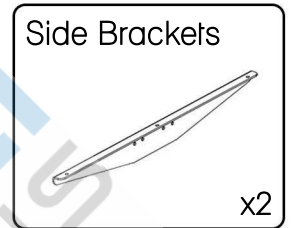
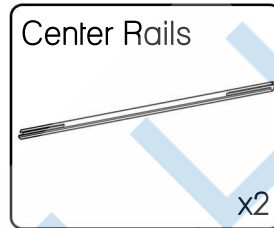
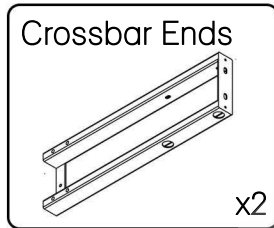
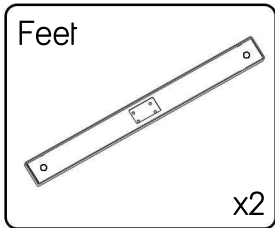
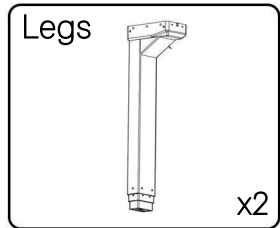

HARDWARE

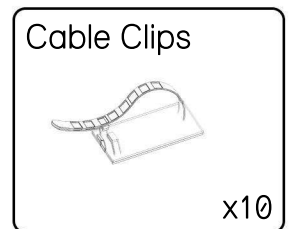
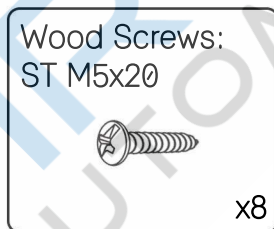
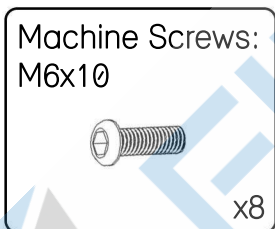
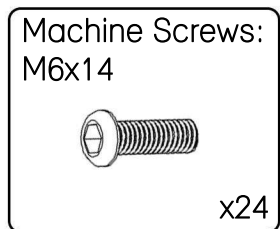

PARTS DIAGRAM

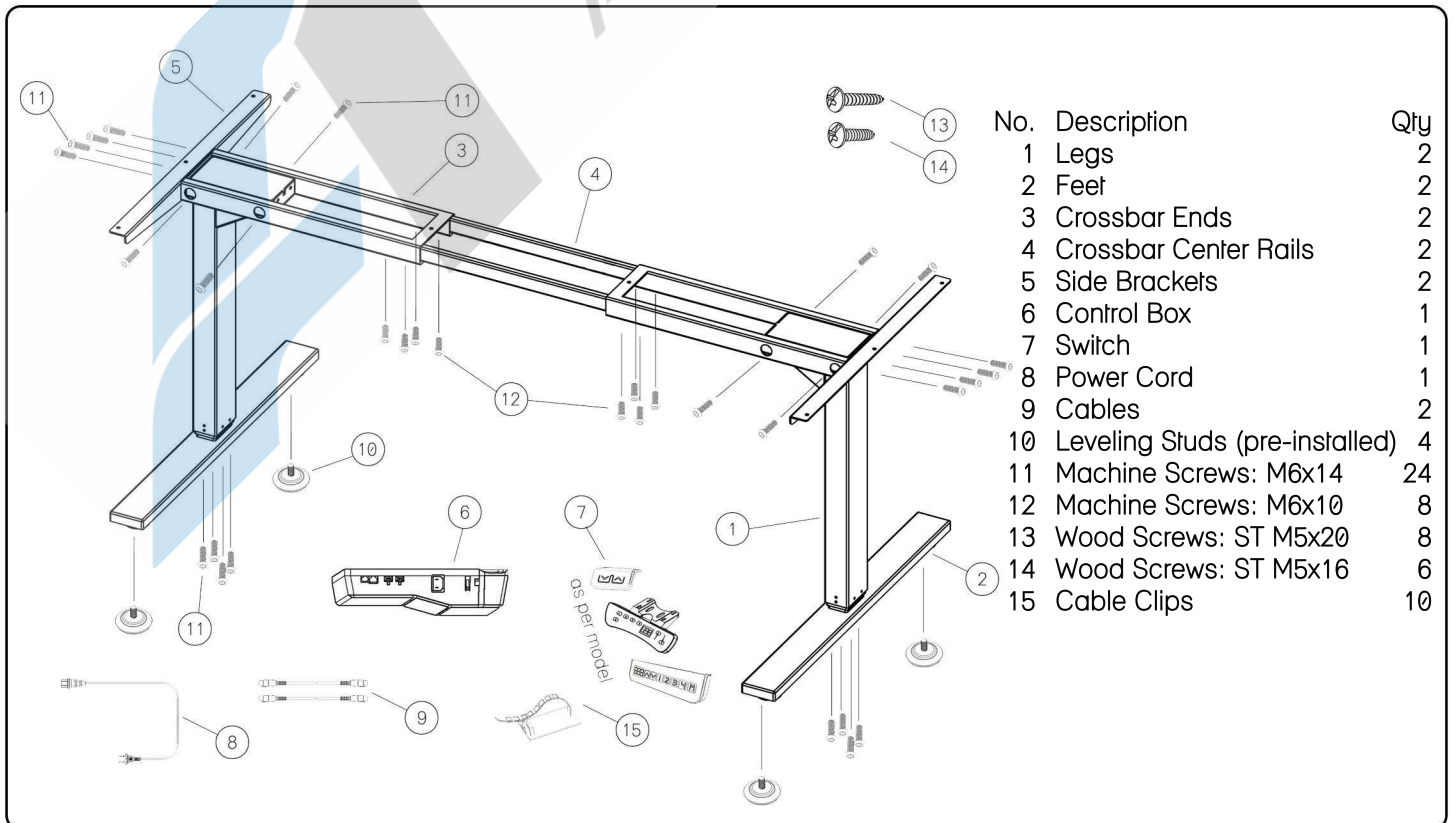

ASSEMBLY INSTRUCTIONS

Lay out all components and hardware to ensure that you have all the components and hardware listed on the parts page.

STEP 1

Fully separate the Crossbar Ends (Part #3). You will find the Crossbar Center Rails (Part #4) inside.

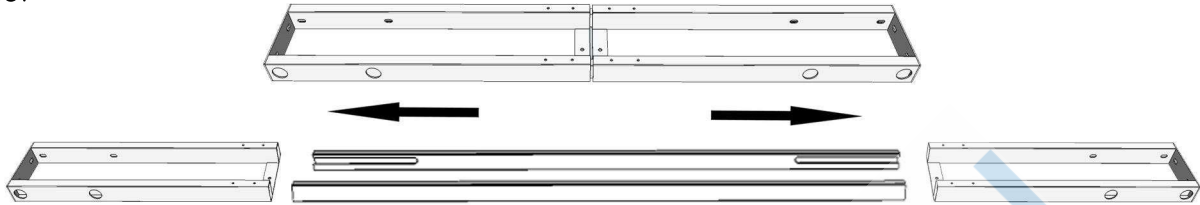

Position one of the Crossbar Ends (Part #3) on its side.

Place one of the Legs (Part #1) into the Crossbar End (Part #3) ensuring that the bar (arrow) is on "top" in relation to the Leg (Part #1).

Line up the holes on each Leg (Part #1) with the holes on each Crossbar End (Part #3).

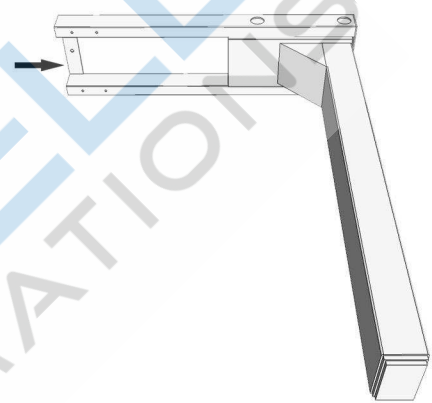

STEP 2

Using the supplied Allen Wrench, insert four (4) M6x14 Machine Screws (Part #11) through the holes in each Crossbar End (Part #3) going into the Leg (Part #1) and rotate each screw just a few turns.

You will need to flip the assembly over to gain access to all four (4) M6x14 Machine Screws (Part #11).

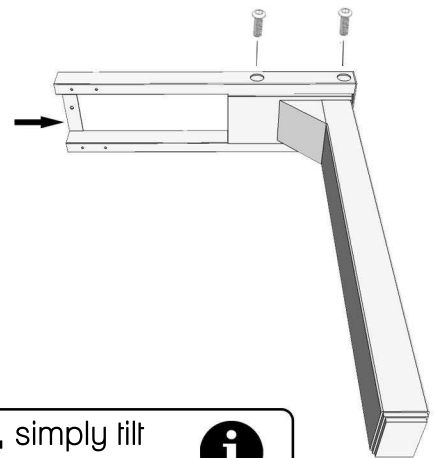

STEP 3

! DO NOT tighten the screws at this point. **!**

i if you drop a screw inside the Crossbar End (Part #3), simply tilt to retrieve the screw. **i**

Prop up one of the assemblies from Step 3, as shown. Insert four (4) M6x14 Machine Screws (Part #11) through the four (4) holes of the Side Bracket (Part #5) going into the Crossbar End/Leg assembly. Using the Allen Wrench, rotate each screw just a few turns.

Repeat Step 4 with the other assembly.

i if you are having difficulty inserting any of the screws from Step 3 or 4, it is because some of the installed screws are too tight. **i**

Now tighten all the screws from Step 3 and Step 4.

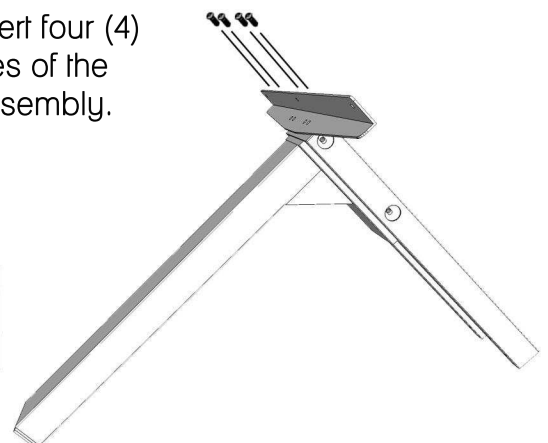

STEP 4

ASSEMBLY INSTRUCTIONS

STEP 5

Slide the two (2) Crossbar Center Rails (Part #4) into the two Crossbar Ends, (Part #3) ensuring:
a) the slots face inward
b) the slot is closer to top edge of the Crossbar Center Rail (Part #4) when the assembly is upside down (see inset).

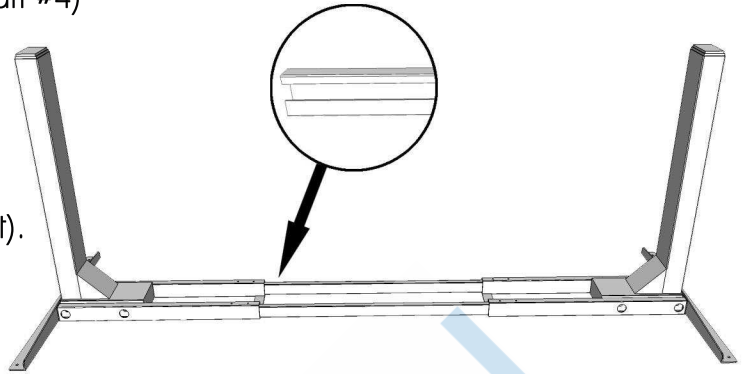

STEP 6

For each assembly, attach a Foot (Part #2) with four (4) M6x14 Machine Screws (Part #11) and tighten screws in a cross pattern.

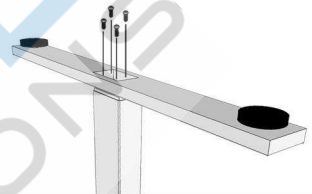

STEP 7

i the minimum desk top size that should be used is: 43" wide x 24" deep **i**

Your desktop may or may not be pre-drilled. Check both sides of the desktop before placing your desk base on the underside of the desktop.

Adjust the width of the desk base to fit the desktop by sliding the two halves outward (42.25" - 74"). We recommend leaving at least 1/2" of the desktop width (on each end) protruding beyond the frame width and centering the base fore and aft.

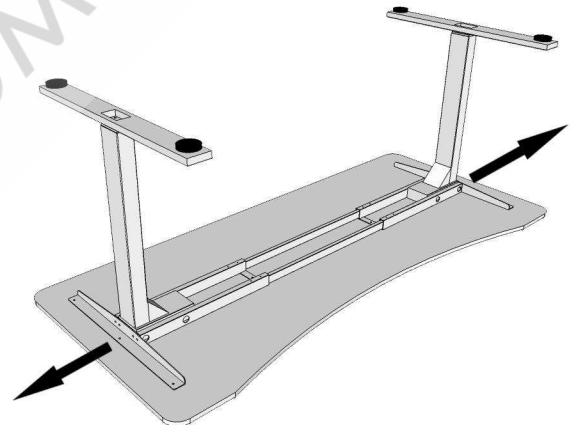

STEP 8

If the desktop is pre-drilled, perform Step 9 before Step 8.

If the desktop is not pre-drilled, lock the position of the Crossbar Center Rails (Part #4) using eight (8) M6x10 Machine Screws (Part #12). Remember, maximum width is 74".

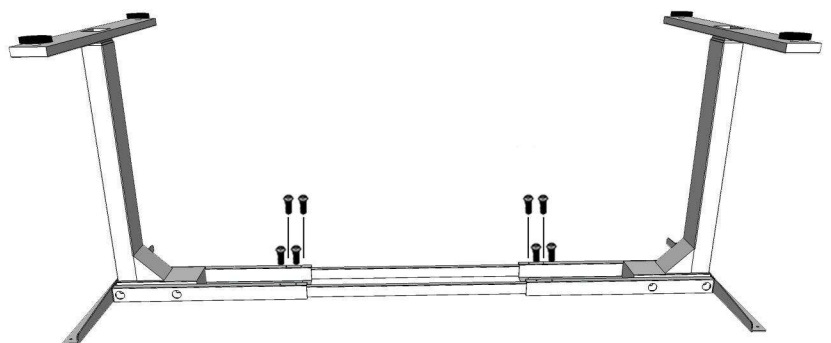

Ensure that the M6x10 Machine Screws (Part #12) contacts the Center Rails (Part #4) by sliding the Center Rails (Part #4) as needed.



ASSEMBLY INSTRUCTIONS



Double-check that the wood screws are not too long for your desktop and won't puncture the surface when screwed all the way in.



We recommend that you pre-drill any holes needed for fasteners connecting the Control Box (Part #6) or Switch (Part #7) to the desktop (if your desktop is not pre-drilled). Never use countersunk screws.



Double-check that the desk base is properly positioned on the underside of the desktop.

Attach the desk base to the underside of the desktop using eight (8) M5x20 ST Screws (Part #13):
3 per Side Bracket (Part #3) - 6 total
1 per Crossbar End (Part #4) - 2 total

Attach the Control Box (Part #6) to the underside of the desktop using four (4) M5x16 Screws (Part #14). Ensure enough clearance at the wire ports for cable connections.

Place the Switch (Part #7) so the front of the Switch is flush with the front desktop edge (or recessed up to 1/8"). The Switch may be placed anywhere along the front edge of your desktop but we recommend placing it toward an end so it does not interfere with your chair when seated. Use two (2) M5x16 Screws (Part #14) to attach the Switch to the desktop.

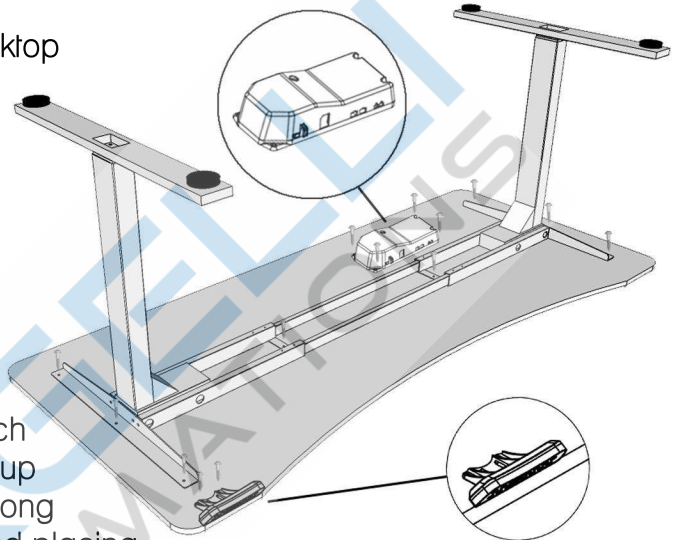

Do not overtighten screws in this step. Overtightening could cause damage to the components.



Connect the:
Cables (Part #9),
Switch Cable (Part #7), and the
Power Cord (Part #8) to the
Control Box (Part #6) as per the diagram.
Use the adhesive-backed Cable Clips
(Part #15) to secure the Cables and
Switch cable, so they don't sag.

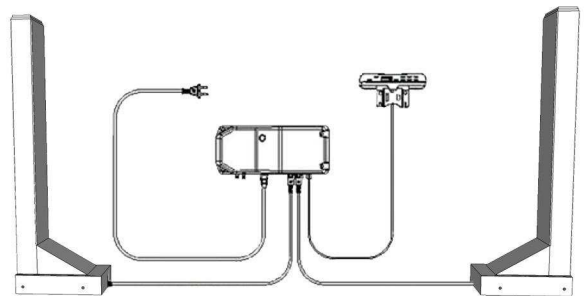

STEP 11

Turn the assembled desk right-side-up. With two people grab the desk BY THE DESK BASE (not the desktop) and turn the desk right-side-up. Adjust the Leveling Studs (Part #10) on the Feet (Part #2) as needed.

ASSEMBLY INSTRUCTIONS

Plug the Power Cord into a 110v outlet.



Make sure no obstacles are in the desk's path.
Make sure the desktop is not touching any walls.
Make sure all cords are appropriate length to accommodate the change in height.



STEP 12

IMPORTANT: You must RESET the desk prior to use.

RESET PROCEDURE: Push and hold the DOWN button on the Switch (Part #7) until the desk reaches its lowest height, slightly rises and stops. Release the DOWN button. Your desk is now ready to use.

To program up to four presets (on some models): Use the up/down buttons to find a desired height, then press "M" ("S" on some models) followed by a number 1 - 4.

CAUTION: Once a preset button is pushed, the desk will move to the programmed height (see caution box above).

TROUBLESHOOTING

If your desk is not functioning properly it may need to be reset. Unplug the power cord for 20 seconds. Plug the power cord back in and follow the RESET procedure outlined in Step 12.

If your desk has a handset with an LED readout and it displays "Er1" or "Er2" confirm that all wired connections are secure (legs to cables, cables to control box). Then perform the reset procedure outlined in Step 12.

If the error message persists after the reset procedure, contact your seller.

If the height between the legs exceeds 1.5 inches, stop the reset procedure & contact your seller.

If the handset displays "HOT", let the base cool down for 20 minutes.

TECHNICAL SPECIFICATIONS

Height Range	23.5" - 49" (without desktop)
Base Width	42.25" min. - 74" max.
Travel Speed	1.5" per second (no load)
Weight Capacity	353 lbs.
Duty Cycle	10%. Max. 2 mins on, 18 mins off
	Soft start/stop
	Adjustable leveling studs
	4 Memory presets (some models)