

Model: FA-GM-58-12-54

FIRGELLI® Rotary Actuator Worm Gear Motors – 12vdc input, with 8mm D-shaft output for high torque applications.

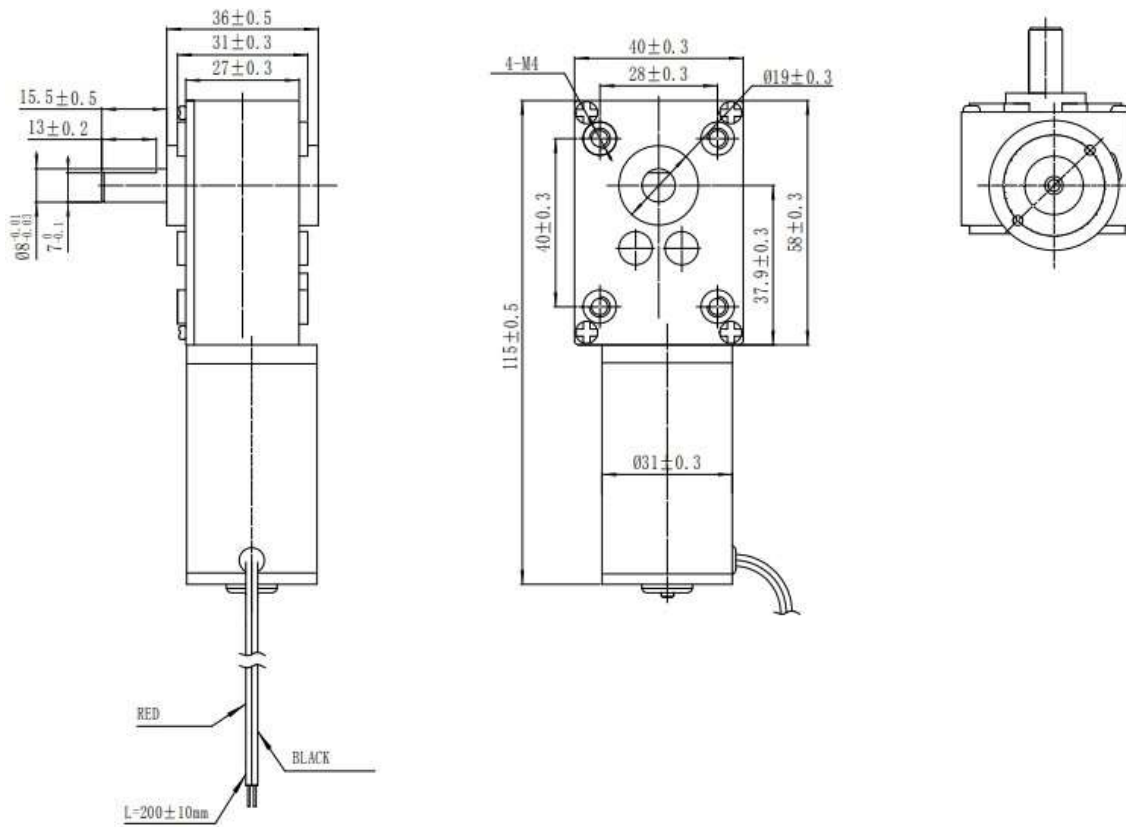

**Specification:**

SKU FA-GM-58-12-54	VOLTAGE	AMPS	INPUT POWER (WATTS)	TORQUE (KG-CM)	RPM	OUTPUT POWER (WATTS)	EFFICIENCY
NO LOAD	12.08	0.199	2.399	0.00	146.3	0.00	0.00
AT MAX EFFICIENCY	11.99	1.470	17.70	3.042	124.7	3.895	22.0
OUTPUT POWER	11.93	4.664	55.66	10.676	70.30	7.715	13.9
STALL	11.80	8.796	103.8	20.567	0.000	0.000	0.00