

FA-BS35-XXX-12v-6

FORCES: 20Lbs (90N) / 90Lbs (400N) / 180Lbs (800N) / 270Lbs (1200N)

Actuator Wiring

Color	Brown	Blue
Extend	-	+
Retract	+	-

TABLE

NO.	Item	Detail
1	Model No.	FA-BS35-XXX-12v-6"
2	Stroke	152.4±7mm [6 in]
3	Voltage	12V DC
4	Free load speed(mm/s)	33mm/s±10% / 18mm/s±10% / 11mm/s±10% / 6.6mm/s±10%
5	Full load speed(mm/s)	28mm/s±10% / 12.7mm/s±10% / 7mm/s±10% / 4.3mm/s±10%
6	Dynamic load capacity	20Lbs (90N) / 90Lbs (400N) / 180Lbs (800N) / 270Lbs (1200N)
7	Cable length(mm)	1524±20%mm [60 in]
8	Front mounting end	thru hole Ø10mm [Ø.394 in]
9	Rear mounting end	thru hole Ø10mm [Ø.394 in]
10	Wire connector	tinned bare wires
11	Limit switches	None
12	Hall sensor	
13	Protection Rate	IP67
14	Free load current (amp)	≤
15	Full load current (amp)	≤

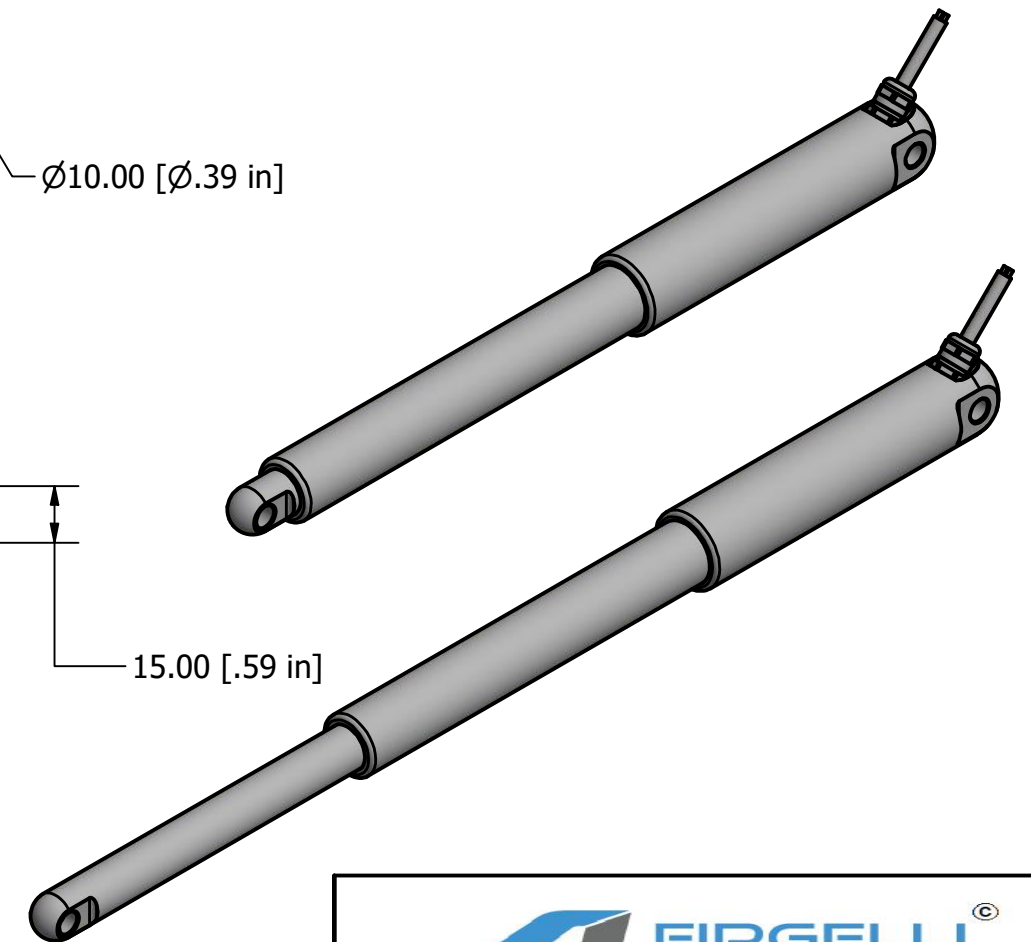
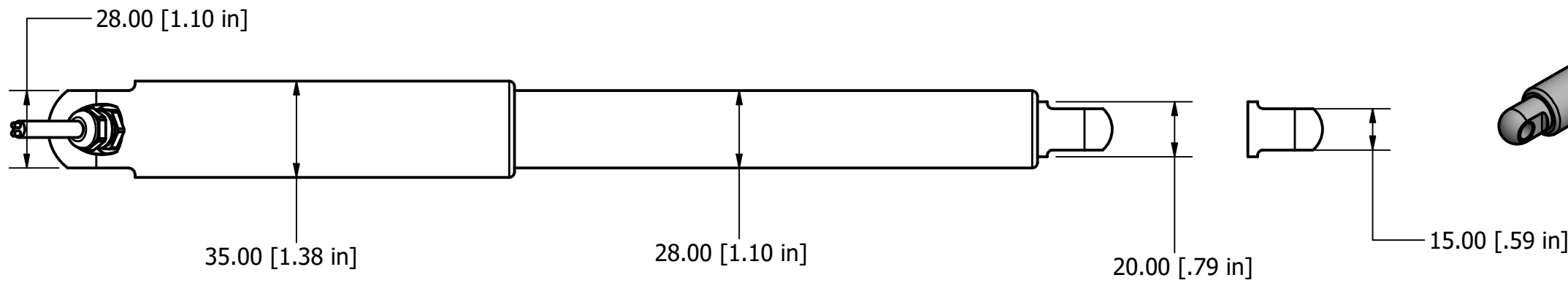
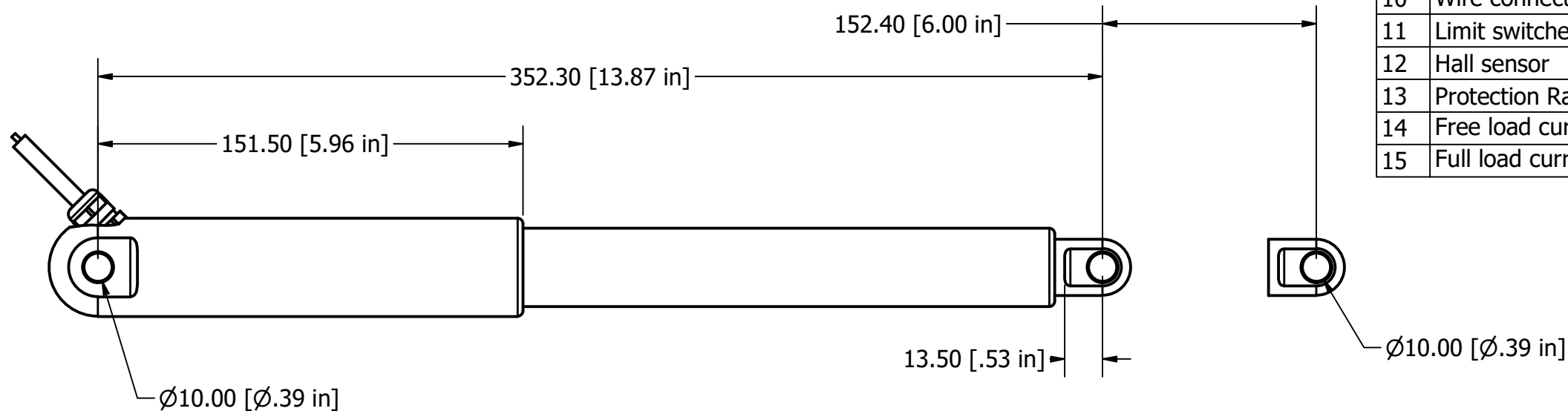

SIZE A3	DWG NO FA-BS35-XXX-12v-6	REV
SCALE 1 / 2	SHEET 1 OF 1	