

F-SD-H-450-12v-22
FORCE: 450Lbs (2000N)

Actuator Wiring		
Color	Brown	Blue
Extend	-	+
Retract	+	-

TABLE		
NO.	Item	Detail
1	Model No.	F-SD-H-450-12v-22"
2	Stroke	559±3mm [22 in]
3	Installation size	734±3mm [28.898 in]
4	Voltage	12V DC
5	Free load speed	6mm/s±10%
6	Dynamic load capacity	450Lbs (2000N)
7	Cable thickness	Six-cores wire
8	Cable length	1000±10%mm [39.370 in]
9	Wire connector	tinned bare wires
10	Front mounting end	Ø8.2mm [Ø.323 in]
11	Rear mounting end	Ø8.2mm [Ø.323 in]
12	Limited switches	Built-in,unadjustable
13	Protection Rate	IP66
	Pulse/mm (single hall)	41.1 pulse/mm

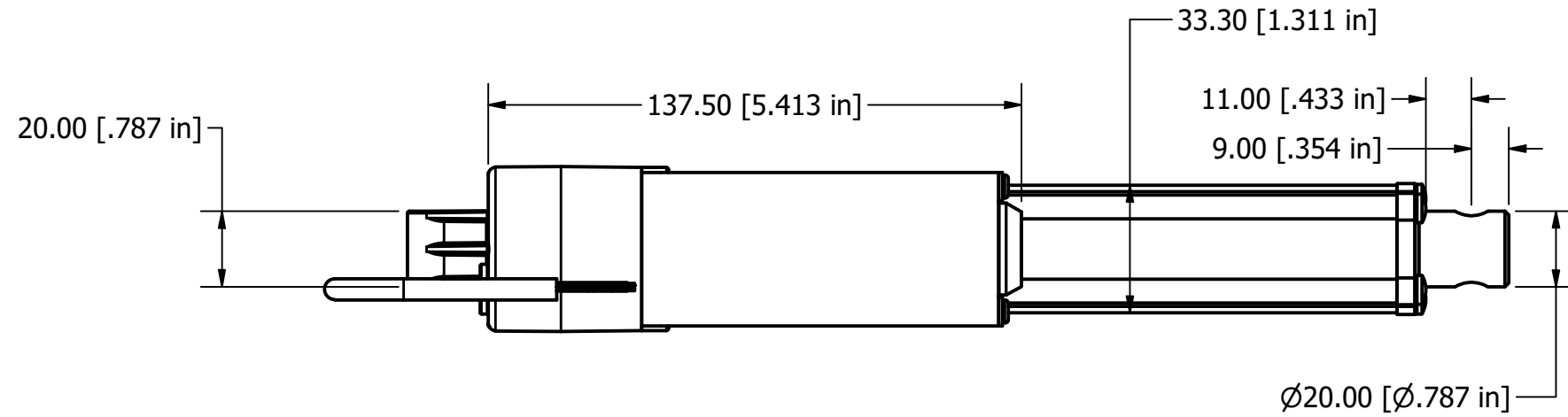

Wiring For Hall Sensor			
c	Red	26AWG	V+(5~15V MAX)
d	Yellow	26AWG	Hall1
e	White	26AWG	Hall2
f	Black	26AWG	V

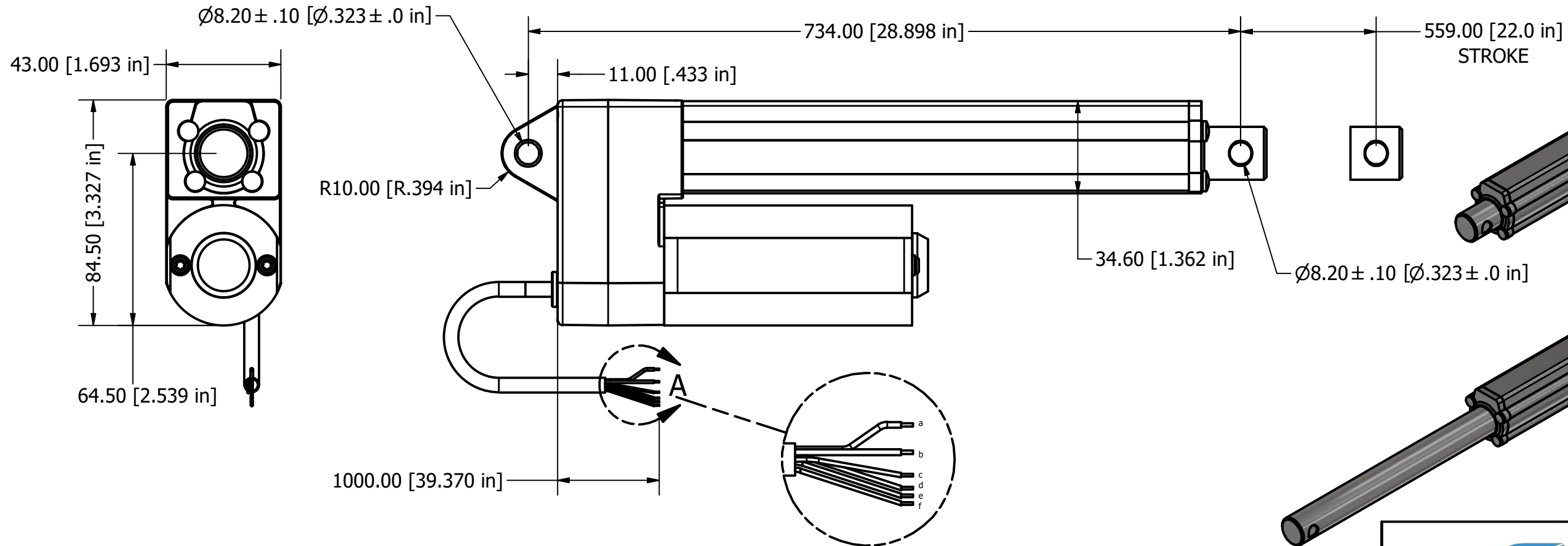

DETAIL A
SCALE 1.25:1

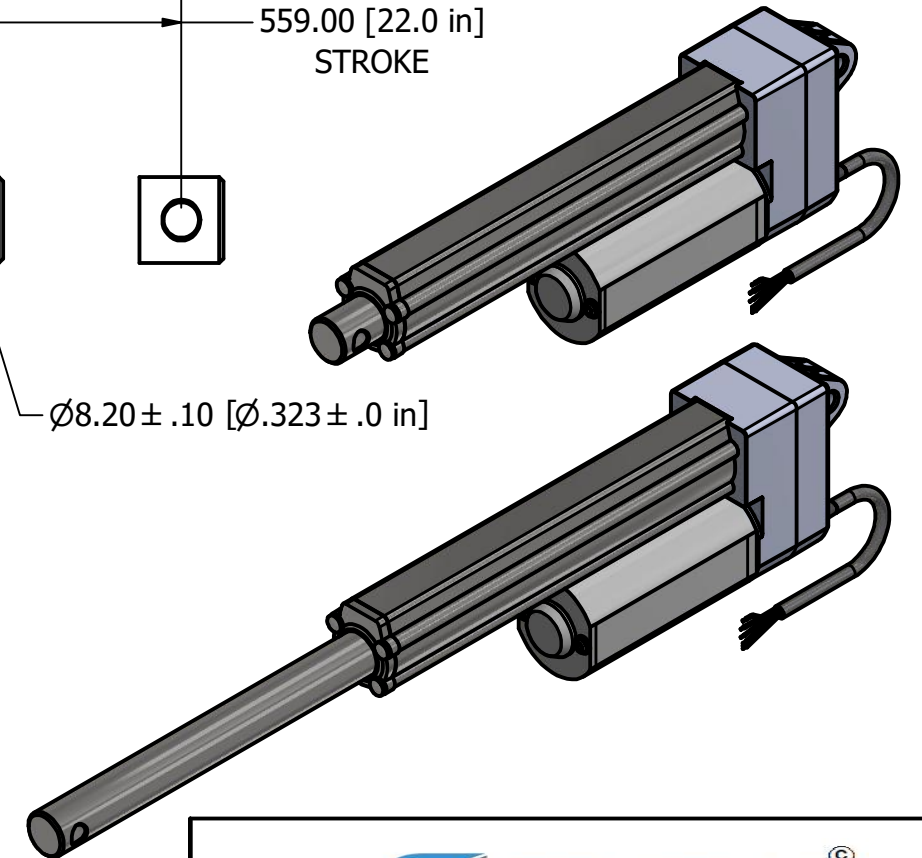

SIZE A3	DWG NO F-SD-H-450-12v-22	REV
SCALE 1 / 1.75	SHEET 1 OF 1	