

F-PM-H-900-12v-20
FORCE: 900Lbs (4000N)

Actuator Wiring		
Color	Brown	Blue
Extend	-	+
Retract	+	-

TABLE		
NO.	Item	Detail
1	Model No.	F-PM-H-900-12v-20"
2	Stroke	508±7mm [20 in]
3	Voltage	12V DC
4	Free load speed(mm/s)	17mm/s±10%
5	Full load speed(mm/s)	14mm/s±10%
6	Dynamic load capacity	900Lbs (4000N)
7	Cable length(mm)	1220±20%mm [48.032 in]
8	Front mounting end	thru hole Ø13mm [Ø.512 in]
9	Rear mounting end	thru hole Ø13mm [Ø.512 in]
10	Wire connector	tinned bare wires
11	Limit switches	Included
12	Hall sensor	Hall*2
13	Protection Rate	IP65
14	Free load current (amp)	≤ 4
15	Full load current (amp)	≤ 17

Wiring For Hall Sensor			
a	Red	24AWG	V+
b	Green	24AWG	Hall1
c	Brown	24AWG	Hall2
d	Black	24AWG	V-

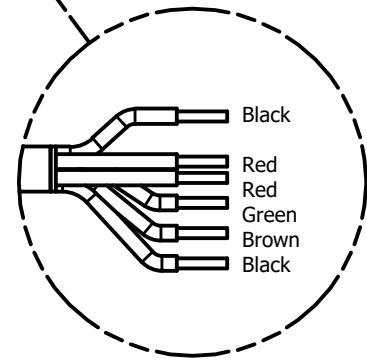
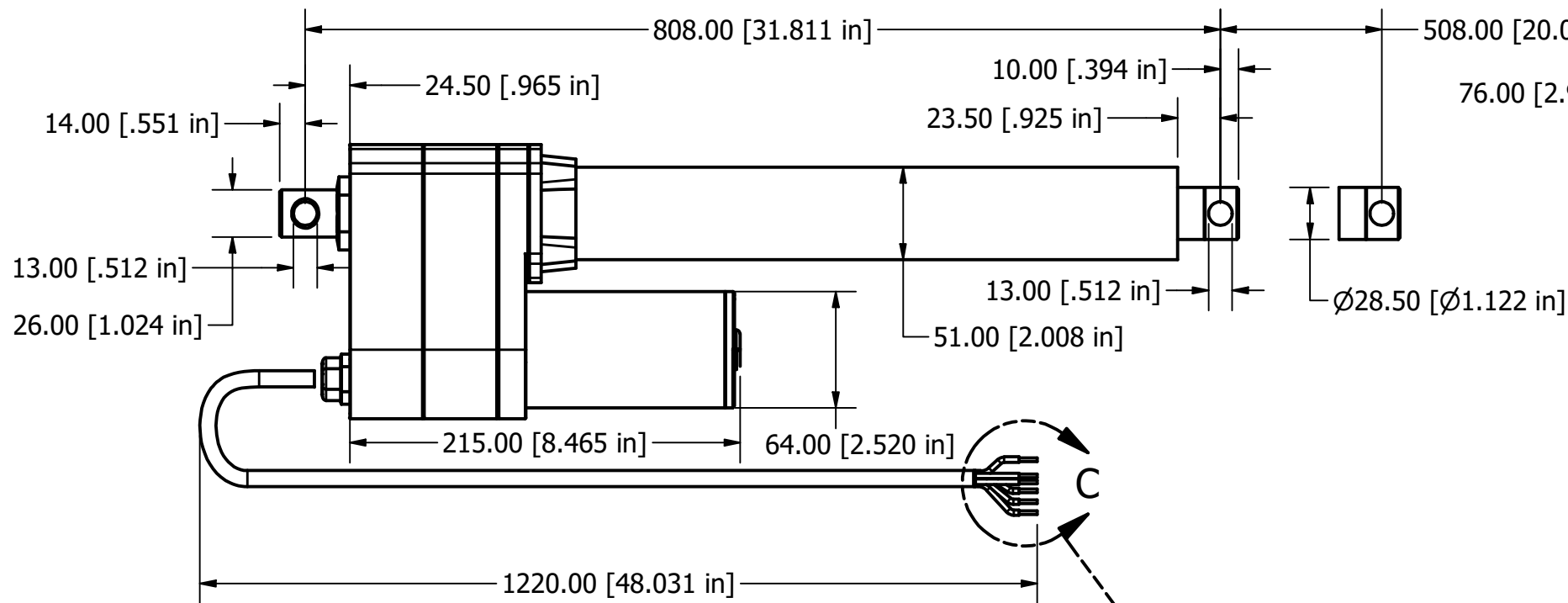

DETAIL C
 SCALE 1 / 1.5

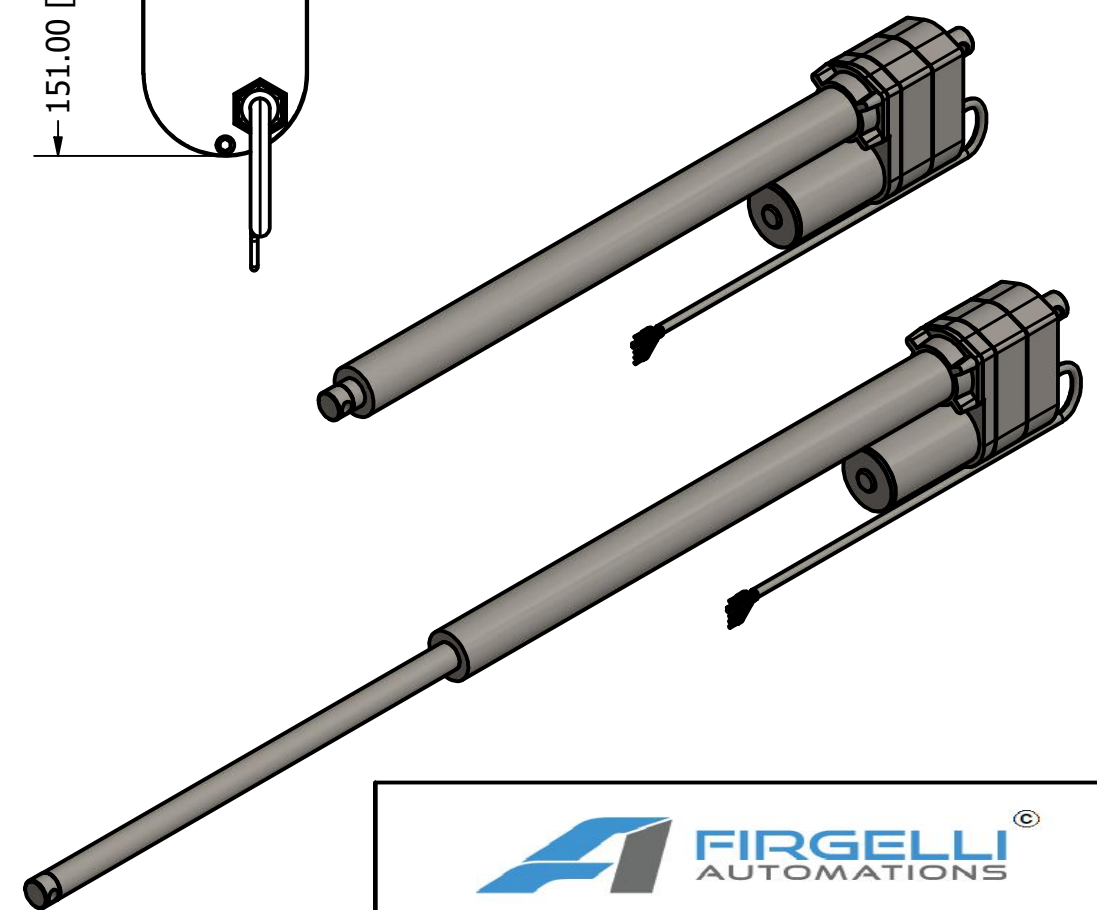



SIZE A3	DWG NO F-PM-H-900-12v-20	REV
SCALE 1 / 3.5	SHEET 1 OF 1	