

FA-U-110-12-12
FORCE: E motor(500N)

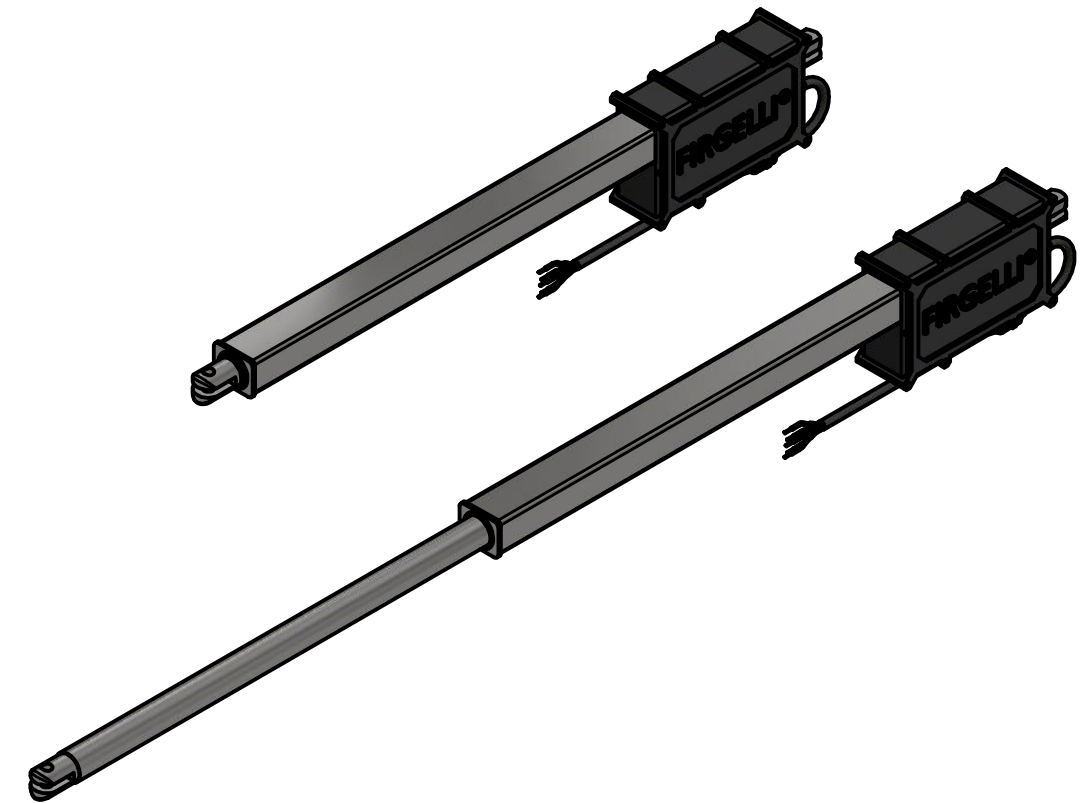
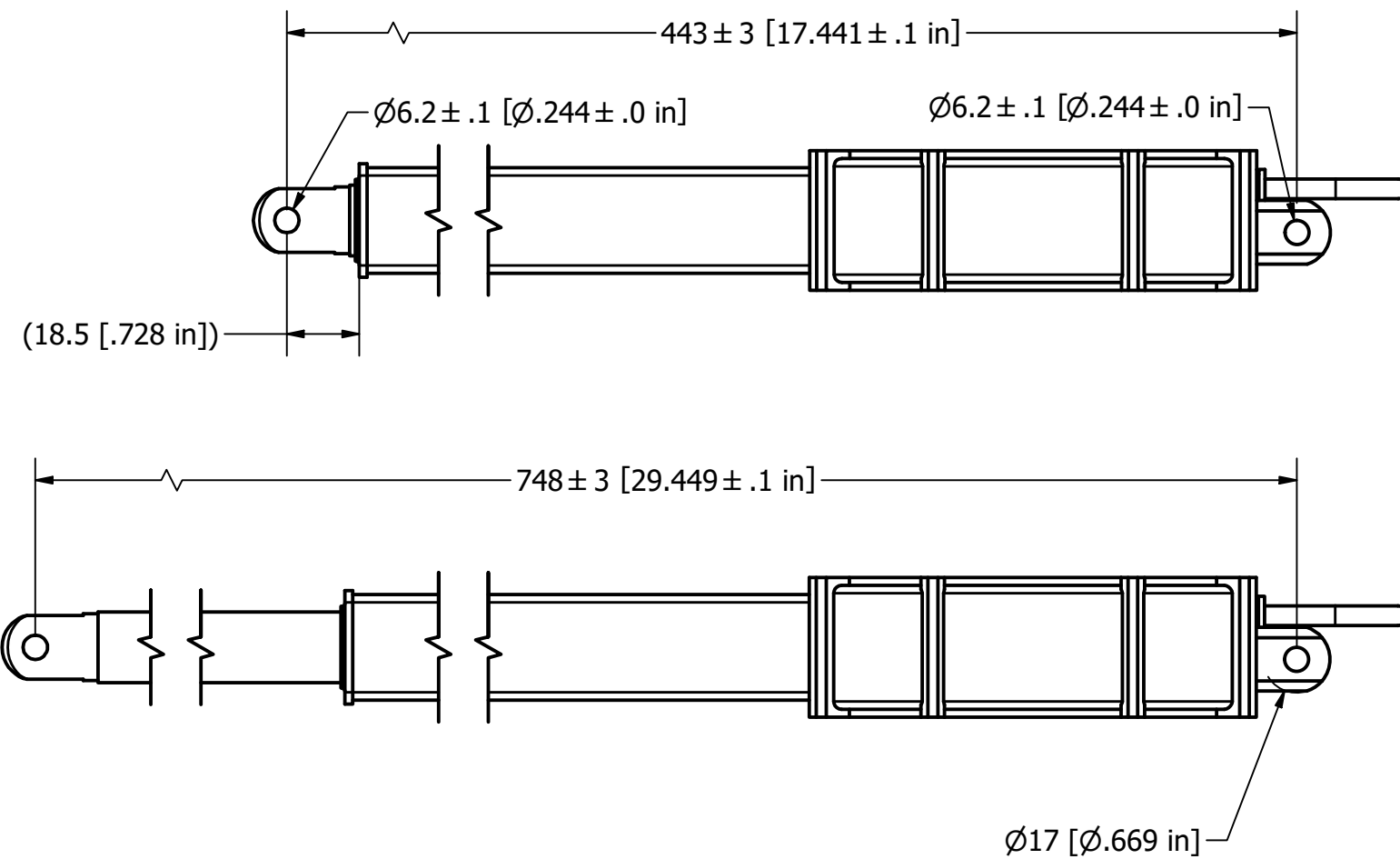
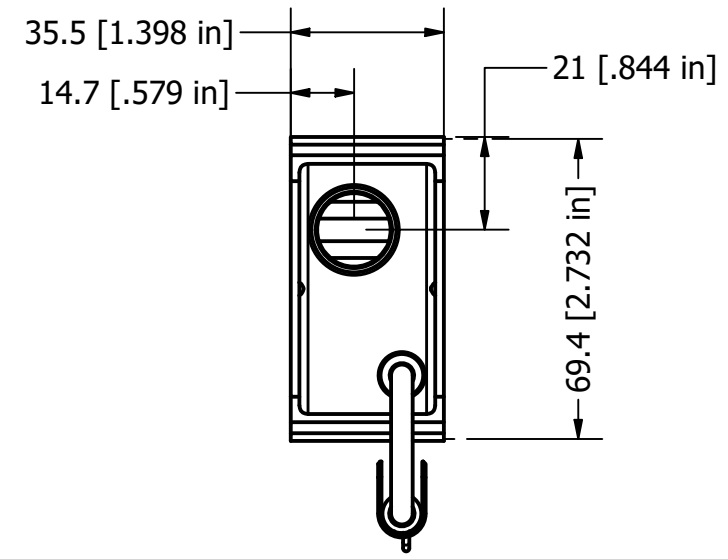
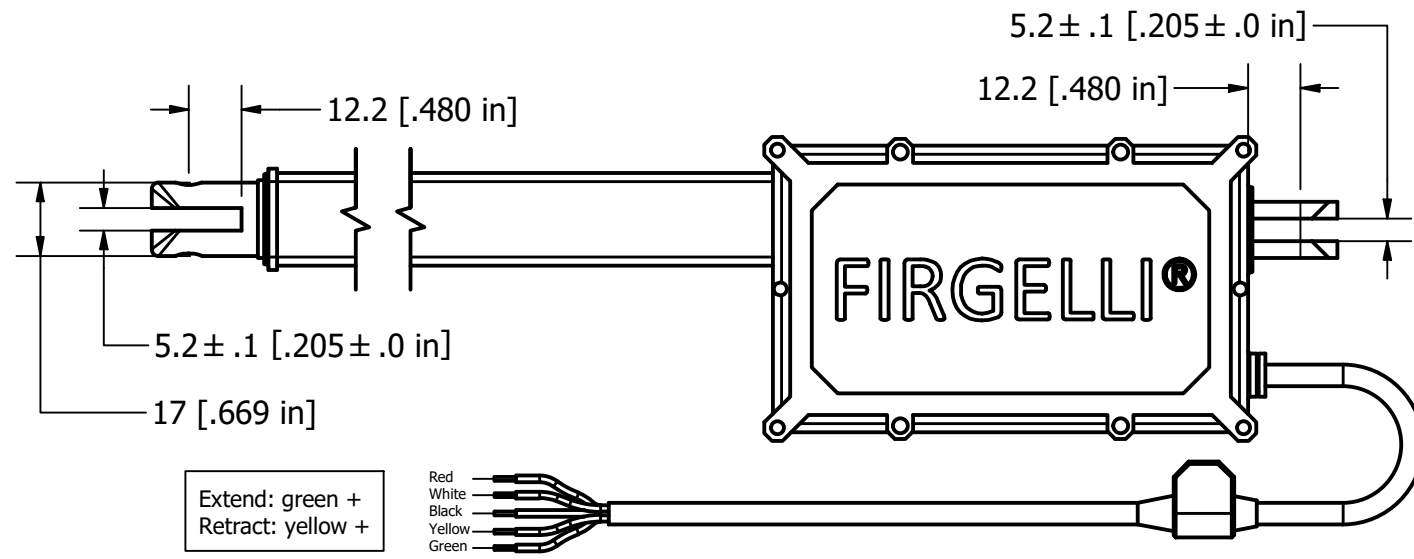

DRAWN	MR ADEBAYO	24/07/2022			
CHECKED					
QA			TITLE		
MFG			ACTUATOR		
APPROVED			SIZE	DWG NO	REV
STROKE	10"		A3	Actuator Drawing	
			SCALE	SHEET 2 OF 2	
			1 / 1.75		