

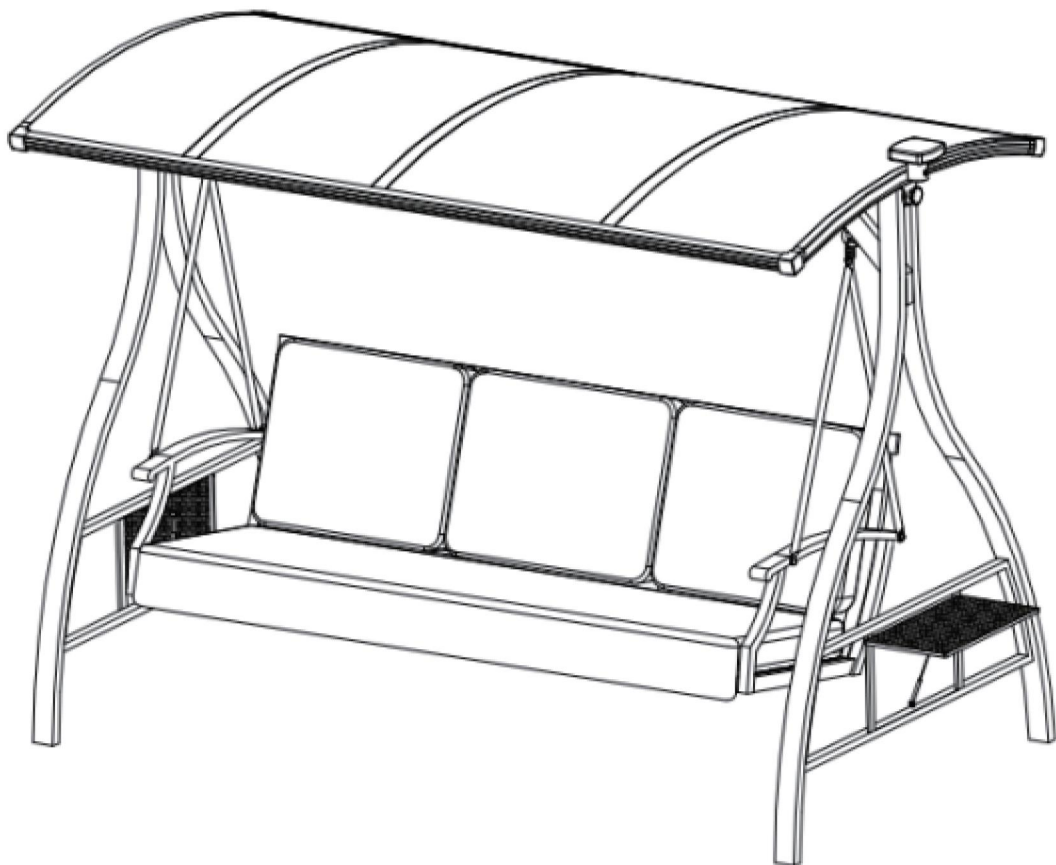

# 3-seat Patio Porch Swing

## ASSEMBLY MANUAL



According to the accessory list in the manual. Check whether the accessories in the carton are consistent with the instruction. If you find missing accessories or have questions, please consult domiserviceEren@outlook.com

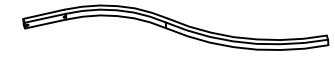

① 4X



② 1X

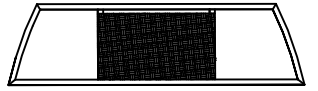

③ 2X

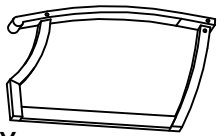

④ 1X

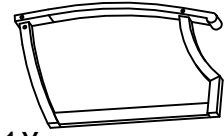

⑤ 1X

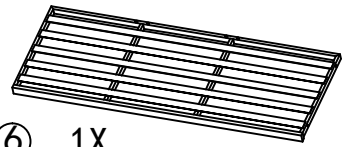

⑥ 1X

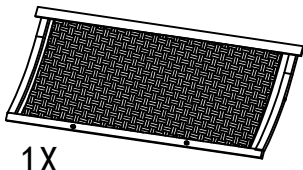

⑦ 1X



⑧ 1X



⑨ 1X



⑩ 2X



⑪ 3X

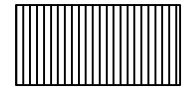

⑫ 4X

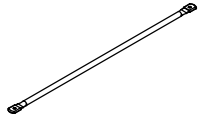

⑬ 2X

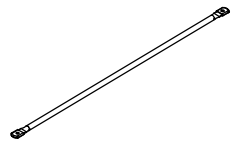

⑭ 2X



⑮ 1X

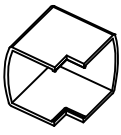

⑯ 4X



⑰ 1X

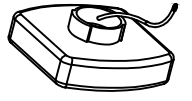

⑱ 1X



⑲ 2X

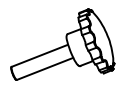

⑳ 2X

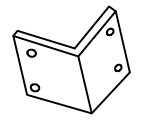

㉑ 4X

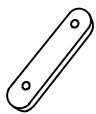

㉒ 6X









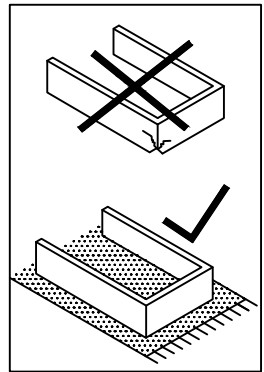





㉓ 1X







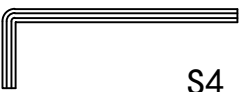
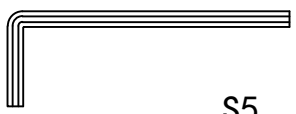
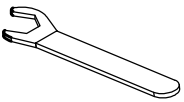
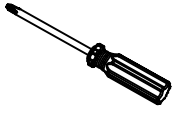

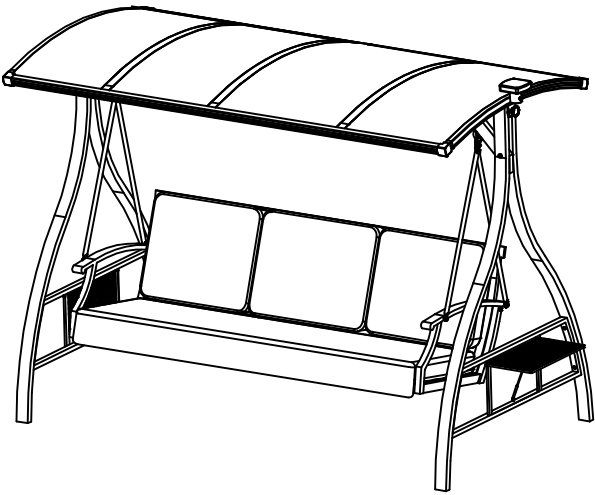

㉔ 2X



1





 25 28X M5*10	 26 6X M6X18	 27 4X M6X28
 28 8X M6X32	 29 5X M6X42	 30 4X M8X25
 31 4X M8X100	 32 22X D6	 33 12X D8
 34 4X M8	 35 1X S4	 36 1X S5
 37 1X	 38 1X	
 39 1X	 40 3X	

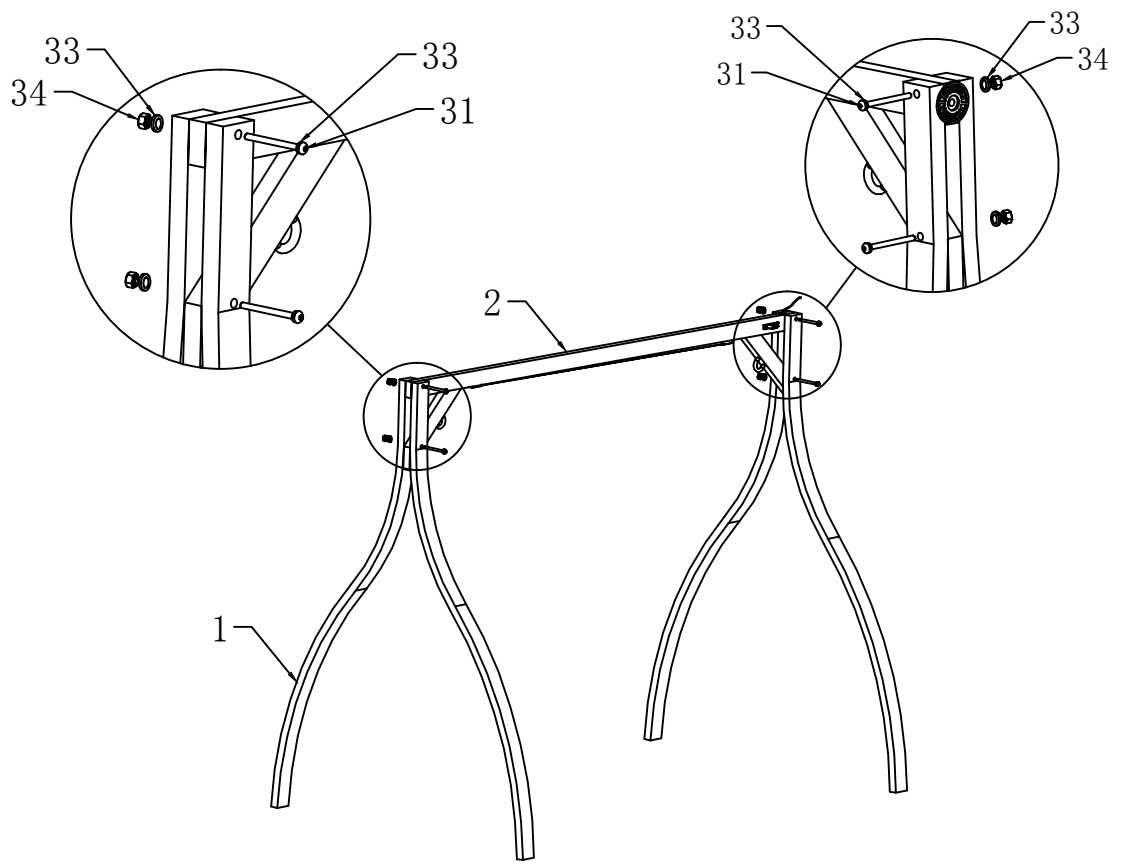

- ① 4X 
- ② 1X 
- ③① 4X M8X100 
- ③③ 8X D8 
- ③④ 4X M8 
- ③⑥ 1X S5 
- ③⑦ 1X 







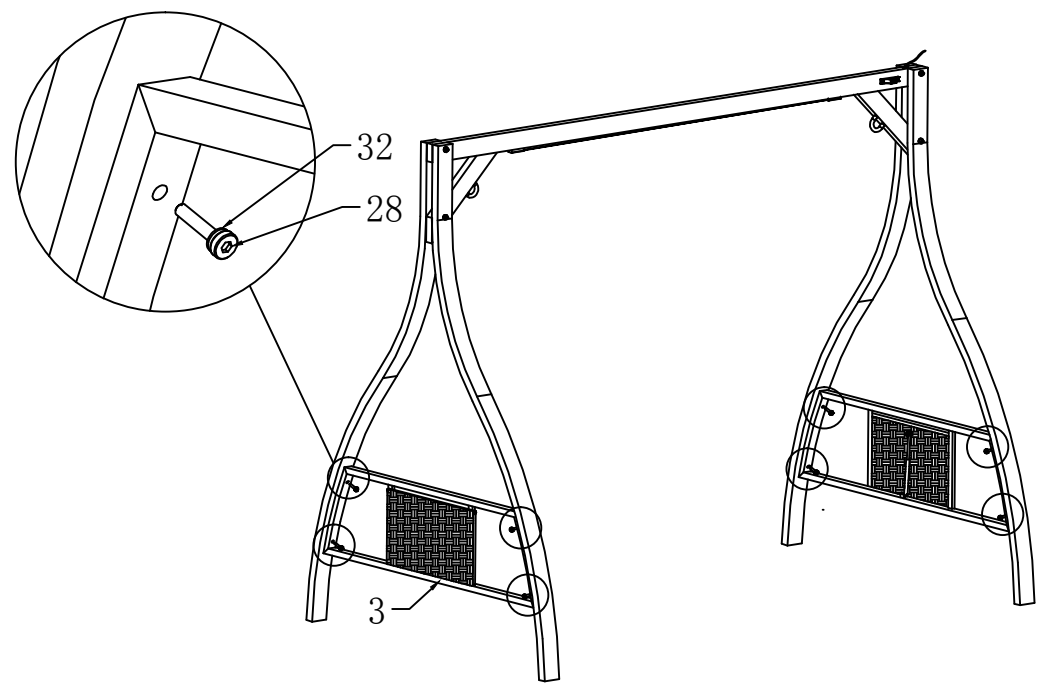

**Step 1: Connect 4 legs part 1 to part 2 using screws 31#,33#,34# as shown**

- ③ 2X 
- ②⑧ 8X M6X32 
- ③② 8X D6 
- ③⑤ 1X S4 



**Step 2: Connect part 3 to the leg part 1 using screw 28# and part 32**



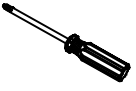

**3**

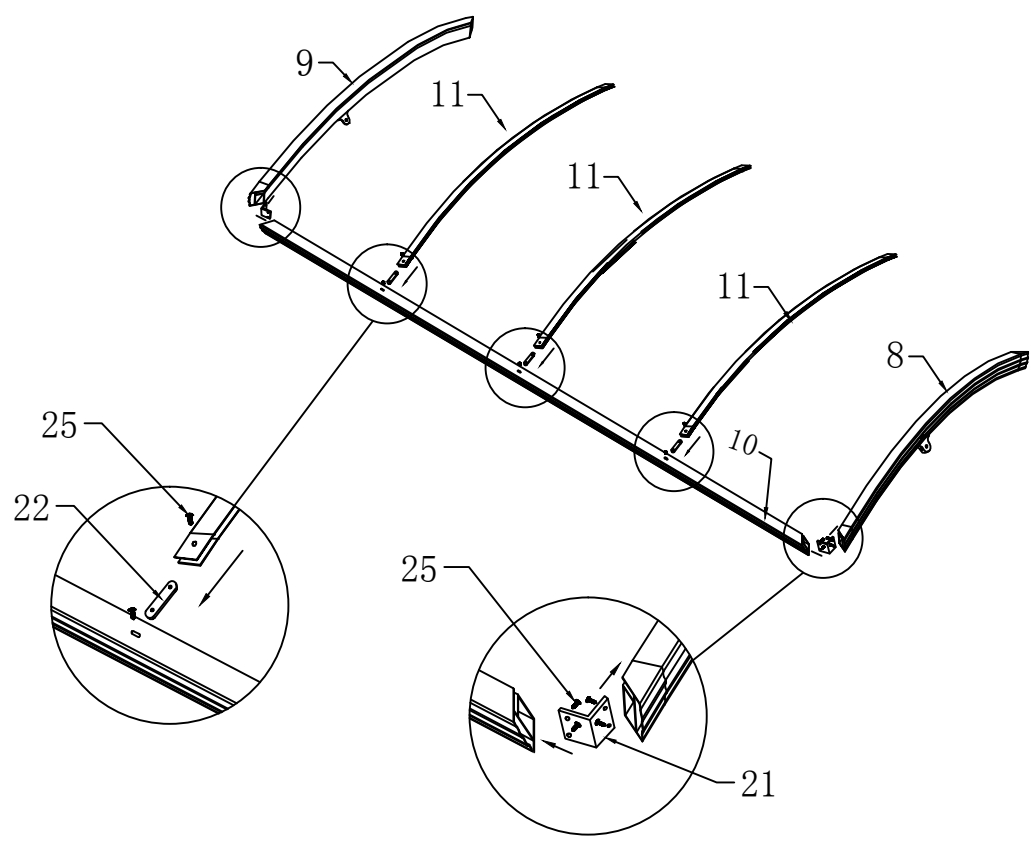
- ⑧ 1X 
- ⑨ 1X 
- ⑩ 1X 
- ⑪ 3X 
- ⑰ 2X 
- ⑱ 3X 
- ⑳ 14X  M5\*10

- ㉟ 1X 





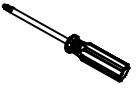

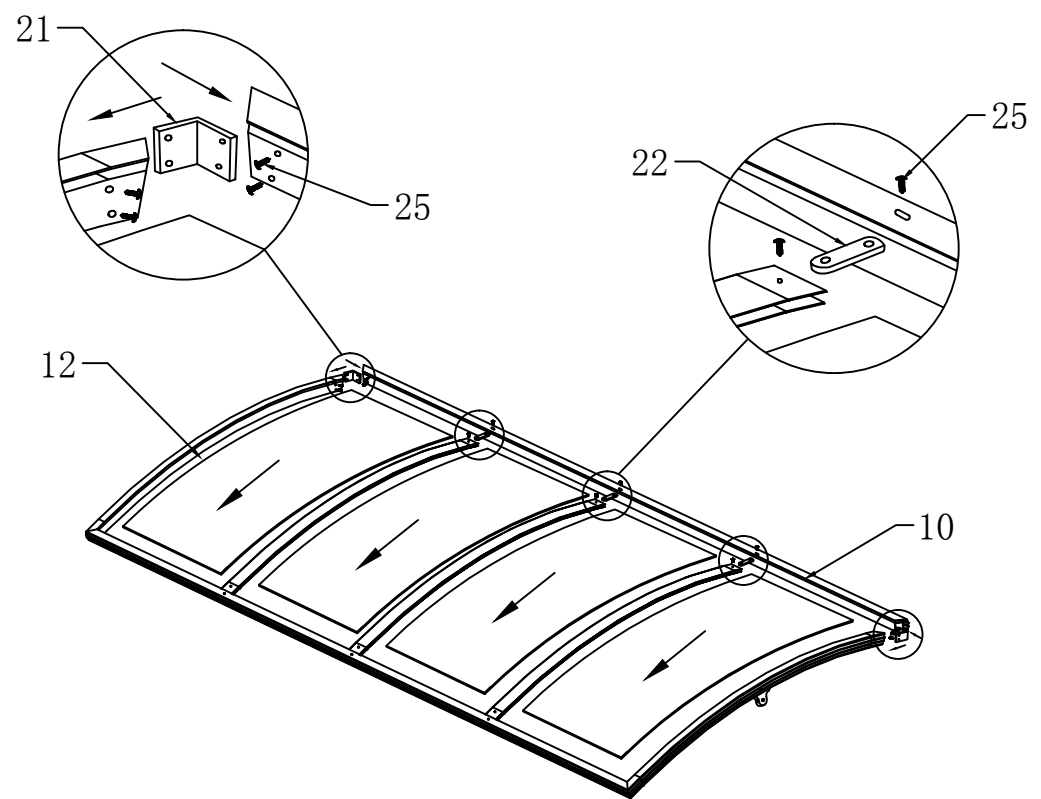

**Step 3: Connect part 8,9 to part 10 using part 21 and screw 25#**  
**Connect 3 pieces of part 11 to part 10 using part 22 and screw 25# as shown**

- ㉒ 4X 
- ⑩ 1X 
- ⑰ 2X 
- ⑱ 3X 
- ⑳ 14X  M5\*10
- ㉟ 1X 







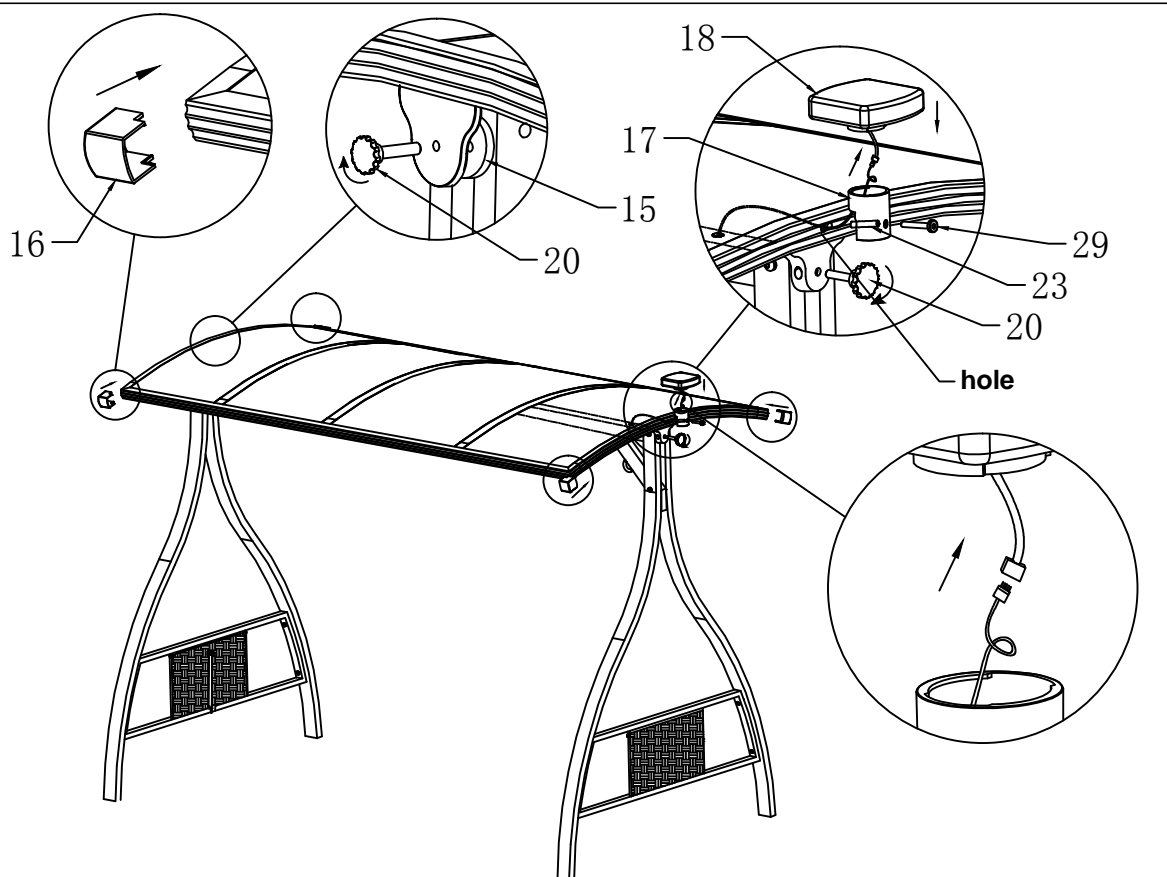









**Step 4: Put 4 pieces of part 12 in the ceiling and connect part 10 to the ceiling using part 21,22 and screws 25# as shown**

- ⑮ 1X 
- ⑯ 4X 
- ⑰ 1X 
- ⑱ 1X 
- ⑳ 2X 
- ㉑ 1X  M6\*42
- ㉒ 1X 



**Step 5: Connect ceiling with part 15,20. Connect the wire through the hole and part 17. Then connect the wire with 18 solar light. connect part 17 to ceiling using 23,29#. Put solar light on 17. and put 4 pieces of part 16 on ceiling as shown**

- ⑳ 1X  S4
- ④ 1X 
- ⑤ 1X 
- ⑥ 1X 
- ⑦ 1X 
- ㉑ 4X  M6\*42
- ㉒ 4X  M6\*28
- ⑳ 4X  M8\*25
- ㉔ 6X  M6\*18
- ㉕ 2X 
- ㉖ 14X  D6
- ㉗ 4X  D8
- ㉘ 1X  S4
- ㉙ 1X  S5

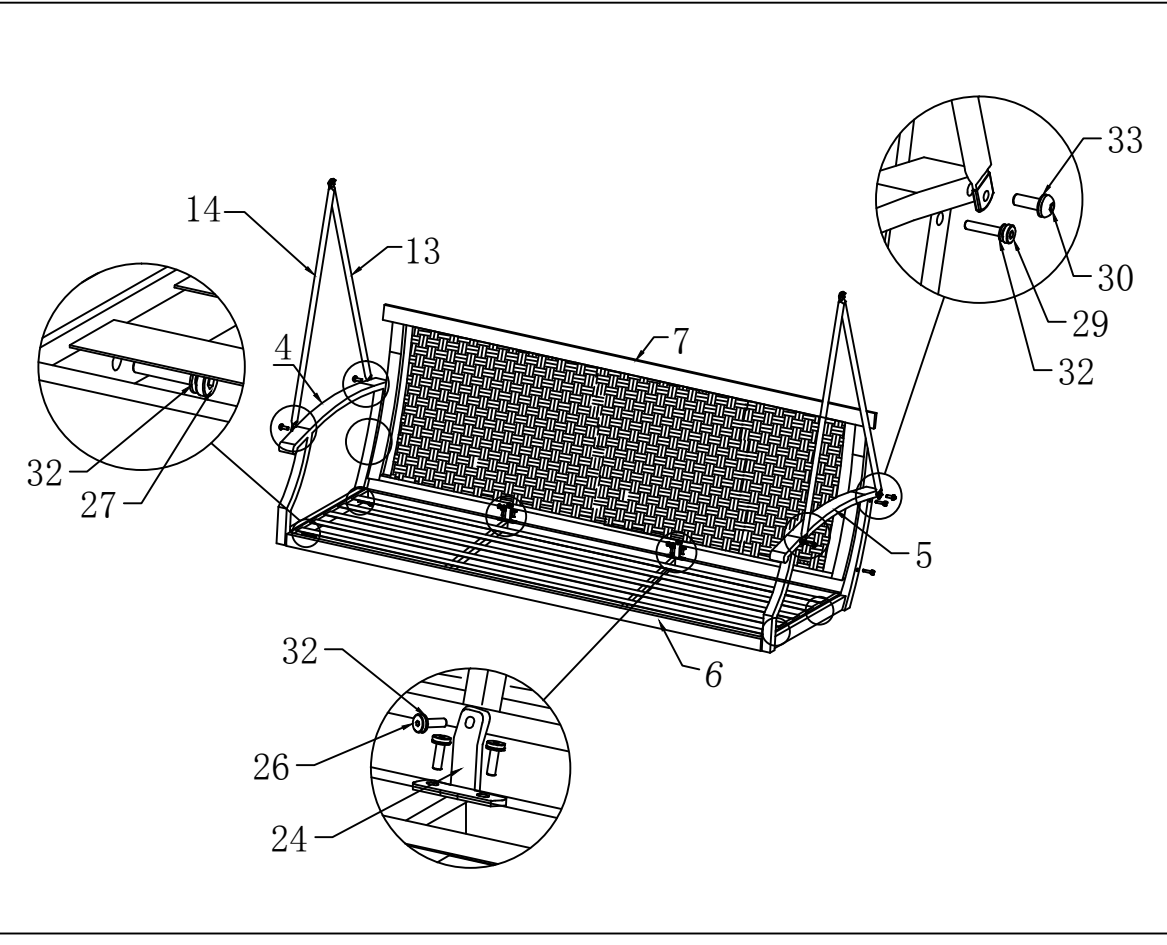

**Step 6: Connect part 4,5 into part 6 using 32,27#. Connect part 6 with part 7 using 24,26# and 32. Connect part 13,14 to part 4 using screws 29#,30#,32,33 as shown**

19 2X



19

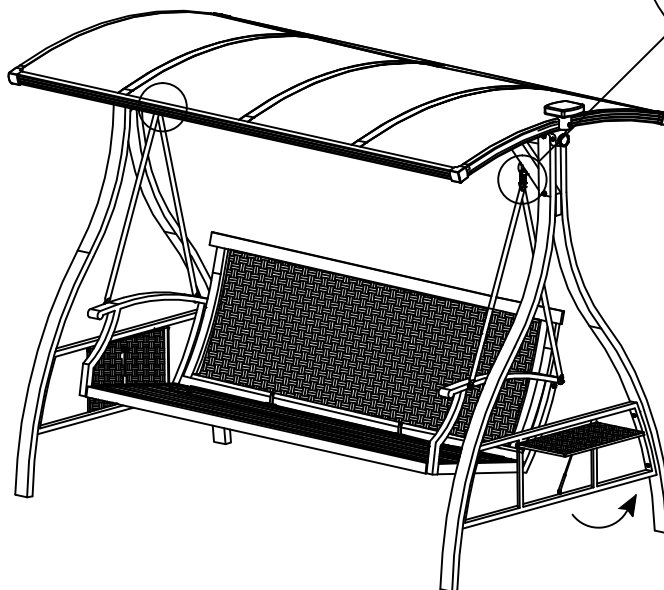
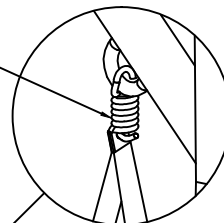

**Step 7: Hang the assembled seat back frame on the legs with spring hook part 19 as shown.**

39 1X

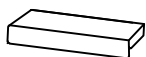

40 3X

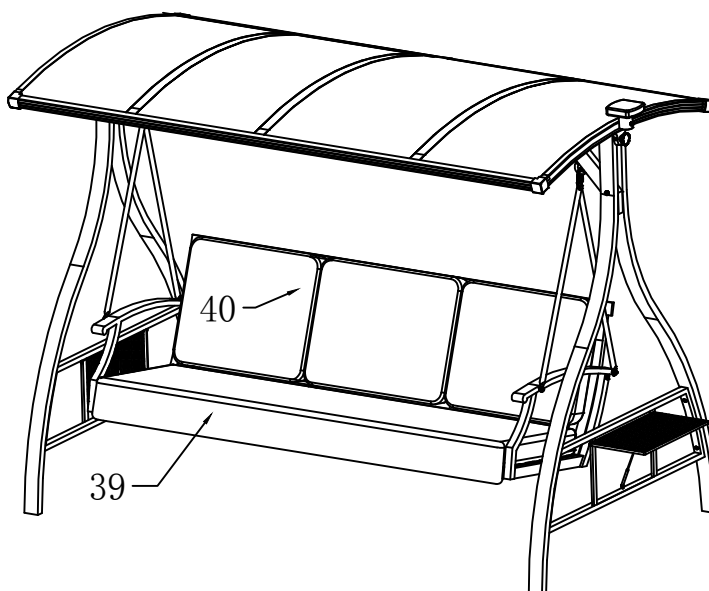

6

**Step 8: Put the seat cushion part 39 and back cushion part 40 on as shown**



RESORT COMFORT IN YONR  
OWN BACKYARD

## Thanks for your purchase.

At domi outdoor living, we believe in our products.

That's why we provide a 12-month warranty and friendly, easy-to-reach after-sales service. So if you have any questions about our product and assembly, please feel free to contact us. We will be here for you.

**Support:**  

email: [service@domioutdoorliving.com](mailto:service@domioutdoorliving.com)

Please tell us your order ID when contact.

Attach photos of damaged part for instant reply.