

## Trolley Systems

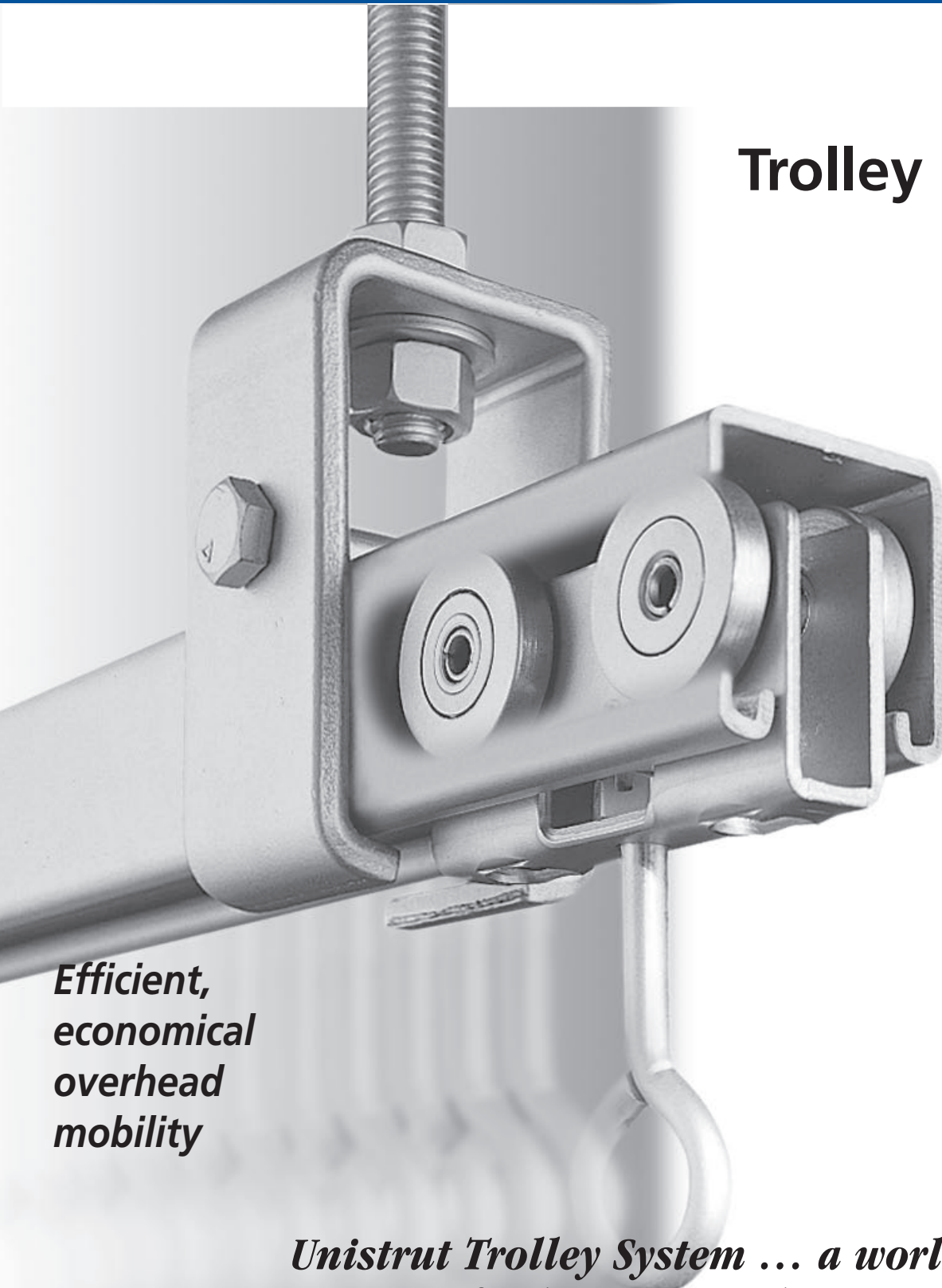

*Efficient,  
economical  
overhead  
mobility*

*Unistrut Trolley System ... a world of  
support, for keeping production on track.*

## *The Unistrut trolley system ... A better approach to overhead mobility...*

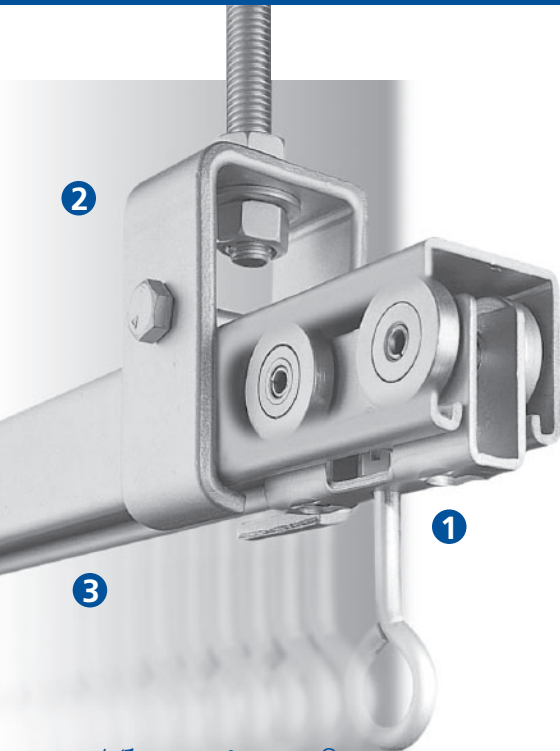

*The Unistrut<sup>®</sup> trolley system offers important advantages over other systems, including greater efficiency, better economy and easier installation*

**1 TROLLEYS**

Stainless-steel wheel bearings and steel or acetyl wheels require no lubrication, providing smooth, maintenance-free operation and long life.

**2 SPECIAL SUPPORT FITTINGS**

... provide strong support while keeping track interior obstruction-free.

**3 CHANNEL TRACK**

Inturned edges form strong, low-friction bearing surfaces.

### **An efficient system that keeps your jobs moving**

The Unistrut trolley system moves equipment from 10 to 600 lbs., with reliability, ease and economy. Trolleys can be ganged to accommodate higher loads. Unistrut trolleys, featuring corrosion-free stainless wheel bearings and steel or acetyl wheels that require no lubrication, deliver built-in value and dependability for a wide range of applications. Throughout the system, famous Unistrut quality assures dependable, trouble-free performance.

### **Simple, versatile, and easy to install**

Composed of three basic elements—trolleys, track and supports—Unistrut trolley systems are efficient and economical. Five different trolleys give users a wide range of weight capacities and suspension options, to allow tailoring of the system to exact application needs.

Track is available in 20-foot sections and can be easily field cut according to project requirements. Longer lengths and curved sections are available on special order. A complete system of easy-to-use supports, including beam clamps, make installation a breeze.

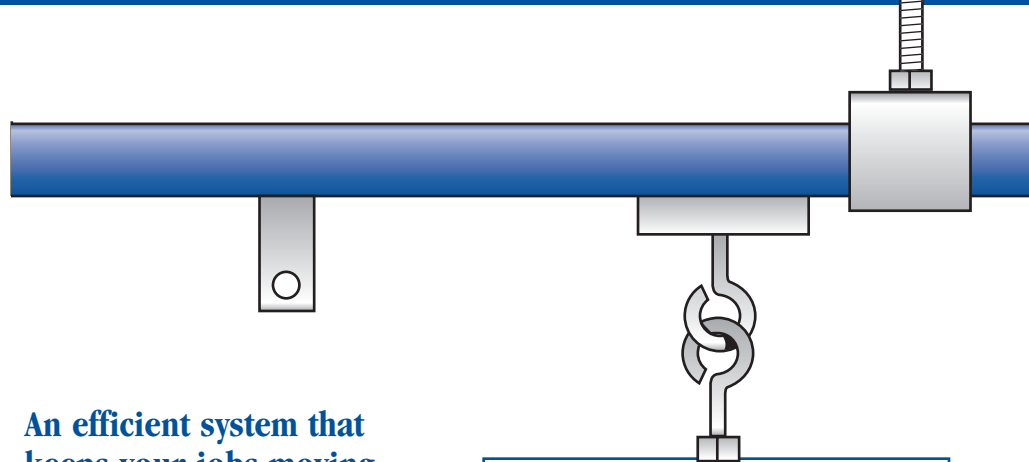

### **IDEAL FOR:**

- *Pneumatic Tools*
- *Lubrication Systems*
- *Moveable Dividers*
- *Rolling Doors*
- *Die Handling*
- *Welding Curtains*
- *Material Transfer*

For detailed load data and related technical detail, see the Unistrut General Engineering Catalog No. 14.

... Proven in thousands of applications throughout North America and worldwide.

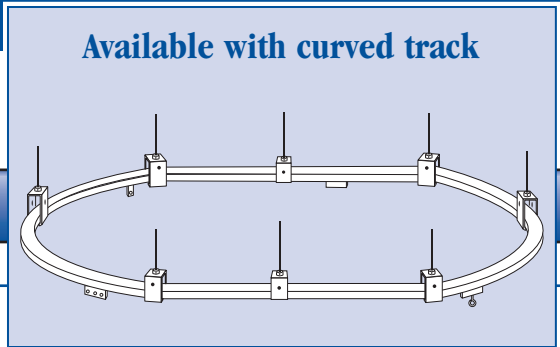

## TROLLEYS

Engineered to accommodate a wide variety of tools, doors, curtains and fixtures.

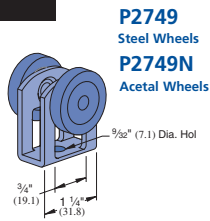

10-50 lb. design load

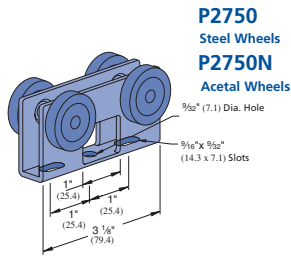
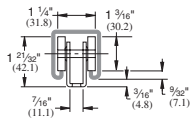

20-100 lb. design load

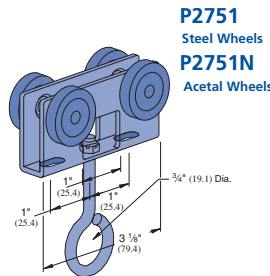
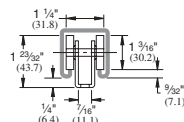

20-100 lb. design load

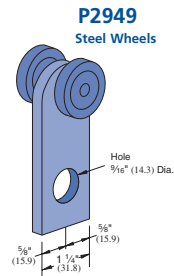
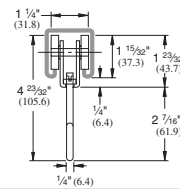

150-437 lb. design load

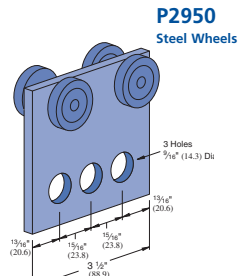
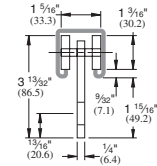

300-600 lb. design load

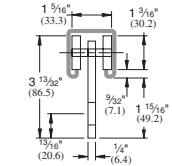

## Curtain Slider

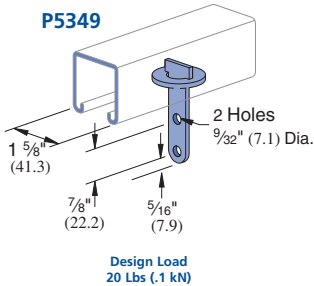

## TRACK

Unistrut 1-5/8" channel, famous for quality, reliability and ease of use.

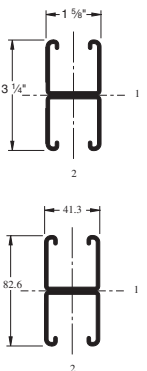
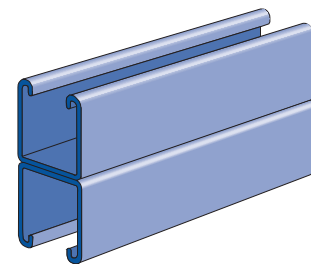
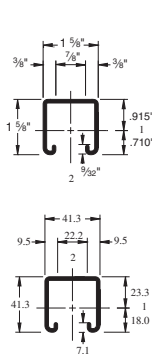
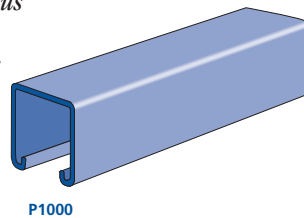

## SUPPORT COMPONENTS

Specifically designed for Unistrut channel track.

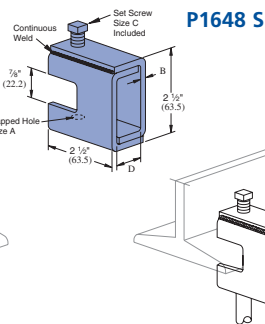
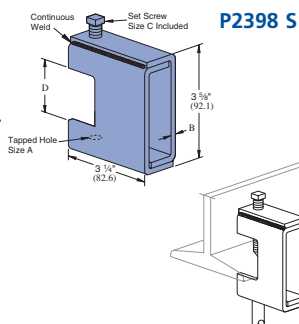

## Beam Clamps

## Channel Track Supports

