



i-grab™

RT-1000 RETRIEVAL TOOL KIT

The RT-1000 Mechanical Retrieval Tool Kit includes four standard jaw sets, control box, 100 ft. of cable and storage case. Made from 300 Series stainless steel, the RT-1000 (1.063" diameter) with gripping viper jaws can exert a closing force greater than 20 lbs. at 30 degrees closure. A 1/4 - 20 tapped hole on the aft end provides mounting options for tool manipulation.

Water proof up to 100 ft.

303 Route 94
Columbia, NJ 07832

908.496.8008

sales@intertest.com

www.intertest.com

RT-1000 DIMENSIONS

Shot imaging™

RVI inspection system solutions

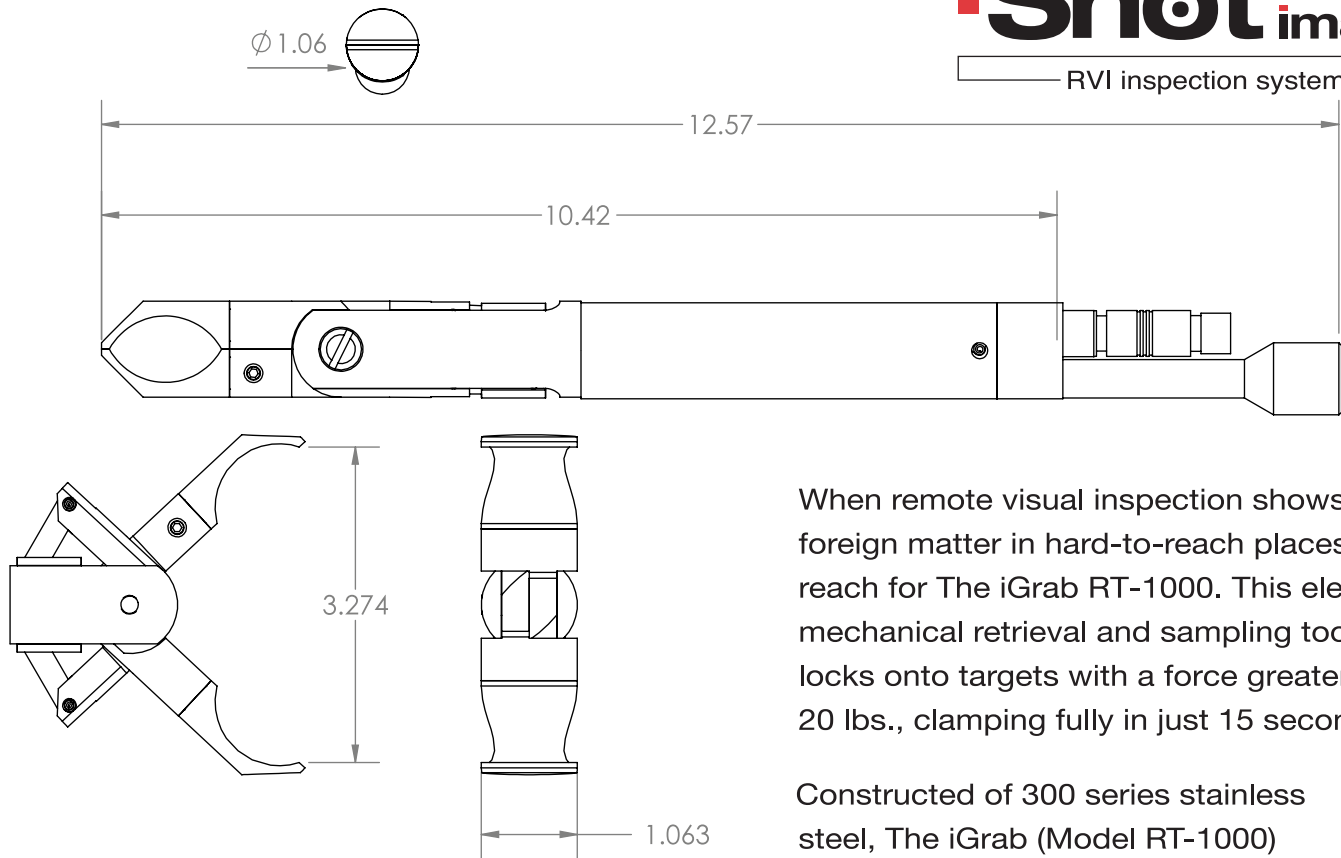

When remote visual inspection shows foreign matter in hard-to-reach places, reach for The iGrab RT-1000. This electro-mechanical retrieval and sampling tool locks onto targets with a force greater than 20 lbs., clamping fully in just 15 seconds.

Constructed of 300 series stainless steel, The iGrab (Model RT-1000) performs numerous retrieval tasks in a variety of environments, including marine and freshwater. Jaws permit quick swapping of plier, fork-and-tine, viper and sampling cup attachments.

Driven by a powerful rare-earth gear motor, The iGrab RT-1000's 141:1 reduction worm drive delivers positive clamping force. Shock-mounting protects all drive components. This tough tool is built to deliver years of service, providing a quick, effective solution when foreign matter threatens the performance of mission-critical equipment.

STANDARD JAW SETS

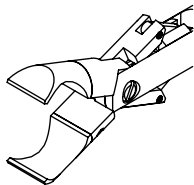

GRIPPING JAWS

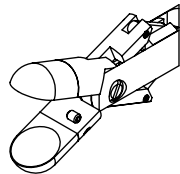

SAMPLE CUP JAWS

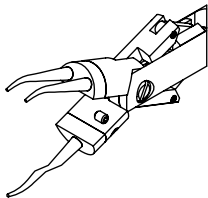

FORK AND TINE JAWS

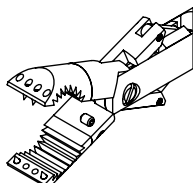

VIPER JAWS

OPTIONAL JAW SETS *(sold separately)*

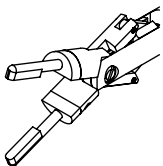

1" PINCERS

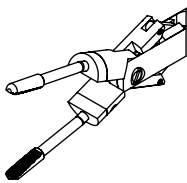

1.5" PINCERS

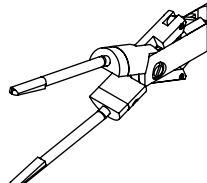

2" PINCERS

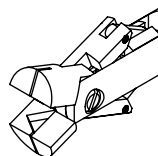

CUTTER JAWS



303 Route 94
Columbia, NJ 07832

908.496.8008

sales@intertest.com

www.intertest.com