



Industrial Videoscope

Operating Instructions



User Instructions

General safety precautions:

Please abide by the following precautions when using the device. The information will be presented with notations related to danger, warnings and precautions in each chapter. Do not use improperly.

Danger

1. Do not use the device to inspect humans or animals.
2. Do not use or store the device near open flame or sources of combustion, strong magnetic field or flammable gas. This could result in fire or explosion.
3. Do not inspect in a live electrified environment to avoid an electric shock.

Warnings

1. Do not repair, disassemble or refit the device by yourself, otherwise InterTest, Inc. hereinafter referred to as InterTest, shall not provide the warranty and repair services.
2. Do not let any liquid other than water come into contact with the insert tube, otherwise it may damage the insert tube.
3. Please make sure to cut off the power to the device before returning the device to the case for storage or transportation.
4. Do not touch the lens at the end of the rotating axis directly while in operation, because it may burn you after use in high temperature environments.
5. In case of smoke or abnormal noise, please stop using the device and immediately shut down the device and disconnect the power.
6. Do not look directly into the light from the end of the rotating axis of the videoscope to avoid affecting your eyesight.
7. If an abnormality in the angular adjustment is detected, stop the current

operation immediately and disconnect the power supply.

Precautions

1. Do not expose the insert tube to environments beyond the temperature range for operation.
2. Do not bend or twist the insert tube. Continued operation may damage the device or reduce its performance.
3. Make sure to use the provided power supply and adapter designated by Yateks Photoelectric and connect the power wire with the three-phase power socket conforming to its rated parameter range. Otherwise it may cause smoke, fire or electric shock.
4. If the device does not seem to be inserting smoothly when inserted into an object or feel something abnormal, do not force the operation. Please withdraw the insert tube carefully. Please note the conditions below when withdrawing the insert tube:
 - a) When the testing angle is locked or the curve part is bent, do not try to withdraw the insert tube from the object;
 - b) If the insert tube is stuck on the way back, rotate the control device slightly while withdrawing the insert tube to prevent damage while removing.
5. When finished and preparing for storage re-straighten the tube. Storing in an angled position can cause undue stress and damage which will affect the device's service-life.
6. Please pay attention to the following matters when operating the end of the insert tube:
 - a) Do not bump the end or drag it by force;
 - b) Do not bump or hit its curved part, or bend it excessively. Otherwise, it may cause the damage of the glass lens and precision components.
7. Long-term use of the product will result in soiling or dirtying of the lens,

causing image blur and accuracy of inspection , please clean it with alcohol or acetone before use to avoid dirt accumulation, corrosion and damage.

8. Do not try to operate the device by force when something abnormal is felt in curve articulation operation. Otherwise it may cause damage to the insert tube or the object it is inserted into.
9. Do not insert any metal objects that are not compatible in port or other openings as this may result in fault or electric shock.
10. Do not bump, press hard or scratch the LCD monitor with anything abrasive or sharp. Otherwise, there may be a crack or scratch on the LCD monitor, which may cause personal injury.
11. Do not cover the device with plastic or other objects during operation. The failure in cooling inside the device may cause damage to the device.
12. Make sure to align video connection cable using the red point guide to ensure proper placement before inserting completely. Forcing this in the incorrect position may result in damage to the cable or connectors.
13. Do not store the device in the following environment; otherwise it may cause the damage of the device.
 - a) High temperature or high humidity with excessive dust or other particles.
 - b) Direct sunlight or radiation.
 - c) In the presence of halide gas or other combustive gases

Contents

I. OVERVIEW.....	1
II. MODEL DEFINITION.....	2
III. MAIN PERFORMANCE PARAMETERS.....	4
IV. PURPOSE AND APPLICATION SCOPE.....	5
V. WORKING ENVIRONMENT.....	8
VI. INSPECTION OF PACKING LIST.....	6
VII. NAME AND FUNCTION OF EACH PART OF THE DEVICE.....	7
VIII. PREPARATION AND INSPECTION BEFORE DETECTION.....	11
8.1 CASE HANDLING.....	11
8.2 INSTALLATION OF DEVICE MONITOR.....	13
8.3 POWER SUPPLY.....	11
8.4 INSPECTION OF INSERT TUBE.....	15
8.5 INSTALLING THE OPERATING HANDLE ON THE DEVICE MONITOR.....	17
8.6 INSTALL AND REMOVE THE SHOULDER STRAP.....	18
IX. BASIC OPERATIONS.....	21
9.1 CONNECTING THE DEVICE MONITOR AND THE OPERATING HANDLE.....	21
9.2 OPERATION GUIDELINE FOR THE DEVICE MONITOR.....	22
9.2.1 The diagram for the Device Monitor.....	22
9.2.2 Power-On and Power-Off.....	22
9.2.3 Installing SD card.....	24
9.2.4 Real-time monitoring.....	25
9.2.5 Image viewer.....	31
9.2.6 Video viewer.....	33
9.2.7 System settings.....	34
9.2.8 Demonstrating the touch screen function.....	37
9.2.9 Data transmission.....	37
9.2.10 PC synchronous images.....	37

9.3 HANDLE OPERATION GUIDE.....	39
9.3.1 Introduction to the operating handle.....	39
9.3.2 Checking the illuminating lights.....	40
9.3.3 Check the articulation function.....	40
9.3.4 Check the angle lock and locking and tuning.....	41
9.3.5 Installing optical adapter (only apply to the IL series).....	41
9.3.6 Inserting the insert tube.....	43
9.3.7 Withdrawing the insert tube.....	45
9.3.8 Introduction to the operating handle button.....	45
X STORAGE AND MAINTENANCE.....	46
10.1 CLEANING.....	46
10.2 REPACKING THE CASE.....	48
10.3 STORAGE PRECAUTIONS.....	48
XI. TROUBLESHOOTING.....	49
11.1 TROUBLESHOOTING GUIDE.....	49
11.2 RETURNING THE DEVICE FOR REPAIR.....	50

I. Overview

The industrial videoscope mainly consists of five parts: camera, insert tube, Device Monitor, display screen and operating handle. It is an innovative nondestructive testing device integrated with optics, precision machinery, electronic machinery, electronic technology and microscopic camera technology. It is designed for use in the detection of surface defects that conventional nondestructive testing technology cannot detect.



Figure 1.1 Industrial videoscope

The industrial videoscope applies 8" IPS HD LCD touch screen with an ultra HD image and resolution ratio as high as 1024*768. Its touch screen, makes operation faster and more convenient; the industrial videoscope applies Yateks leading patent technology, able to rotate the probe at 360 degree and transmit the image over a long distance so that a deeper pipeline detection can be observed; it utilizes an HD camera module making the image clearer; with the highlight LED lighting functionality, the LED brightness can be adjusted to Grade Five on the basis of the HIE series products, reaching more than 10,000Lux. The brightness can be adjusted to the best condition for the inspection work based on the brightness of the inspection site; it also applies industrial control board, making it faster in processing and clearer in imaging.

The product sketch map is as shown as Figure 1.2.

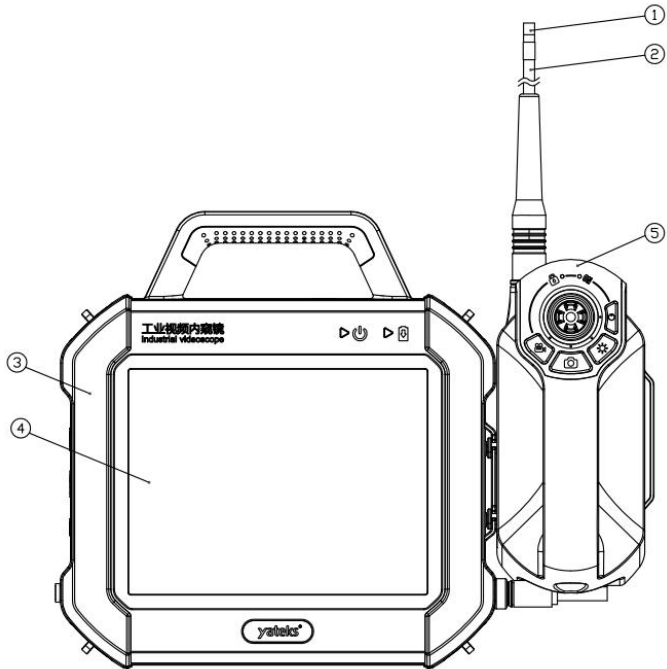
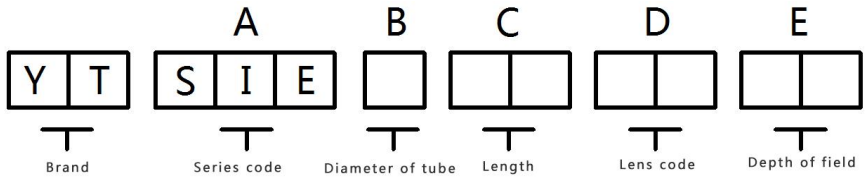

Figure 1.2 Product sketch map

- ①- Camera ②- Insert tube ③- Device Monitor Housing ④- Display screen
⑤- Operating handle

II. Model Definition

In order to meet the requirements of different environments, the User can select insert tube with proper diameter and length based on the actual need. The product model is named according to the code of the diameter and length of the insert tube. Product Model number naming convention is detailed below:



Code	Description	Note
A (Series code)		
SIE		
B (Diameter of tube)		
3	2.8mm	
4	4mm	
6	6mm	
C (Length)		
10	1.0m	
15	1.5m	
20	2.0 m	
30	3.0m	
50	5.0 m	
80	8.0 m	
D (Lens code)		
PG	3.9mm/ 120°	Diameter:4mm Length:1-5m
QB	5.5mm/ 100°	Diameter:6mm Length:1-8m
PD	6mm Dual camera/ 80°	Diameter:6mm Length:1-3m
PA	2.8mm /70°	Diameter:2.8mm Length:1-2m
YB	2.8mm Fiber /70°	Diameter:2.8mm Length:1-2m

YC	3.9mm Fiber /70°	Diameter:4mm Length:1-3m
YD	3.9mm Fiber Interchangeable lens/70°	Diameter:4mm Length:1-3m
YE	6mmFiber/70°	Diameter:4mm Length:1-3m
YF	6mm Fiber Interchangeable lens/70°	Diameter:6mm Length:1-3m
E (Depth of field)		
A1	7-80mm	PG、QB
A2	3-25mm	PG、QB
A3	3-20mm	YC、YD、YE、YF
A4	5-80mm	YC、YD、YE、YF
A5	8-150mm	YC、YD、YE、YF
A6	10+∞	YC、YD、YE、YF
A7	10-50mm	YA、YB
A8	5-30mm	YA、YB
A9	10mm-100mm and 5mm-50mm	YD

III. Main performance parameters

System	Dimension	246 mm * 321 mm * 123 mm
	Weight	2.3 Kg (~5lbs)
	Display screen	8" IPS industrial high definition LCD touch screen with resolution ratio of 1024*768
	Control lever	Electric rocker with a lens able to rotate in 360 degrees
	Probe reset	Automatic reset
	Direction fine tuning	Direction fine tuning adjustable
	Function	Photography, video, brightness control,

		locking and fine tuning			
	Internal storage	32G high speed SD card			
	Data I/O port	SD card interface, VGA video signal interface, charge interface and USB interface			
	Battery	4 × 18650 Li-ion batteries (replaceable)			
	Standby time	3H			
	Operating mode	Portable			
	Brightness control	10-grade brightness adjustment			
Front video probe	Working length	0~1m	1~2m	2~3m	3~8m
	Articulation angle	180 ± 10°	150 ± 10°	120 ± 10°	100 ± 10°
	Effective pixels	Direct view of 1,000,000 pixels			
Software	Operation system	Real time multitasking operation system			
	User interface	Touch screen operation menu			
	File management	Support image and video play, delete, format and naming			
	Image control	Zoom in/out, playback			
	Image format	JPG/PNG (record the date and time)			
	Video format	AVI (record the date and time)			
	Language	English / Chinese			
	Software upgrading	Upgrade available through interfaces			

IV. Purpose and application of scope

This device is widely used for modern core industrial production and inspection for aviation, automobile, watercraft, electric and chemical. Characterized by direct visualization, it can check if the inner surfaces of large equipment like pipelines, turbines, cylinders and engines have defects or abnormalities. Additionally, it allows real time photo and video recording to provide indispensable data collection for the equipment's condition analysis and equipment production support.

V. Working environment

Working temperature	-10°C~50°C (14F to 122F)
Temperature for storage	-10°C~40°C (14F to 104F)
Dust proofing and water proofing of video probe	IP67

Note

Standard operating environment cannot ensure the equipment will not have failure or malfunction.

VI. Inspection of packing list

No.	Description	Unit	Qty.	Remark
1	Device Monitor	Set	1	
2	Operating handle	Pcs	1	
3	Probe to Monitor Cable	Pcs	1	
4	Li battery	Pcs	8	
5	Charger	Pcs	1	
6	Mini USB data wire	Pcs	1	
7	AC adapter	Pcs	1	
8	32G SD card+ card box	Pcs	1	
9	SD card reader	Pcs	1	
10	Serial Number Labels	Pcs	2	
11	Device shoulder strap	Pcs	1	
12	HDMI cable	Pcs	1	
13	Touch pen	Pcs	1	
14	Non-dust cloth	Pcs	1	

15	Rubber cap	Pcs	1	
16	Instructions	Pcs	1	
17	Certificate of compliance	Pcs	1	
18	Warranty card	Pcs	1	

VII. Name and function of each part of the device

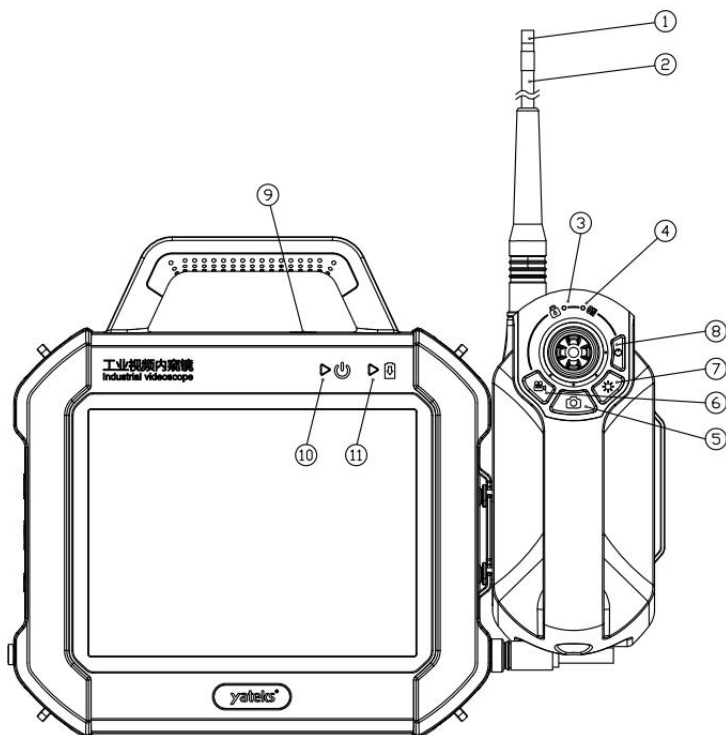

Figure 7.1 Name and figure of each part of the host

No.	Description	No.	Description
1	Camera	7	Brightness
2	Insert tube	8	Locking / tuning

3	Locking / tuning	9	Device monitor switch
4	Power indicator	10	Power on/off indicator
5	Photograph/ Dual camera switching	11	Charging indicator
6	Video		

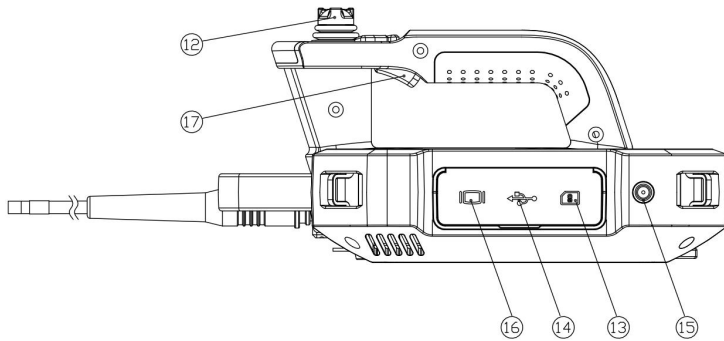

Figure 7.2 Name of each part of operating handle

No.	Description	No.	Description
12	Rocker	16	HDMI interface
13	SD card interface	17	Photograph/ Dual camera switching
14	USB interface	18	Quick coupling
15	DC interface	19	Probe to Device Monitor cable

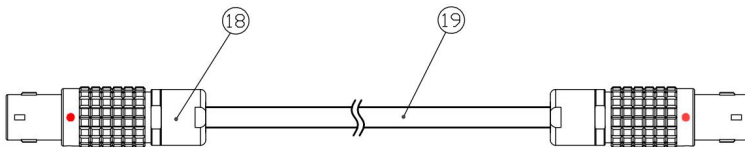

Figure 7.3 Diagram of signal cable

VIII. Preparation and inspection before detection

8.1 Case handling

Notes

- Please check if the handle and the fasteners of the case are secure before transporting.
- To avoid damage, please transport the system using only the standard storage case supplied by InterTest.

■ When using the handle of case

- 1) Make sure the latches are locked tightly before lifting the case.
- 2) The case is equipped with rollers to be used on flat surfaces.

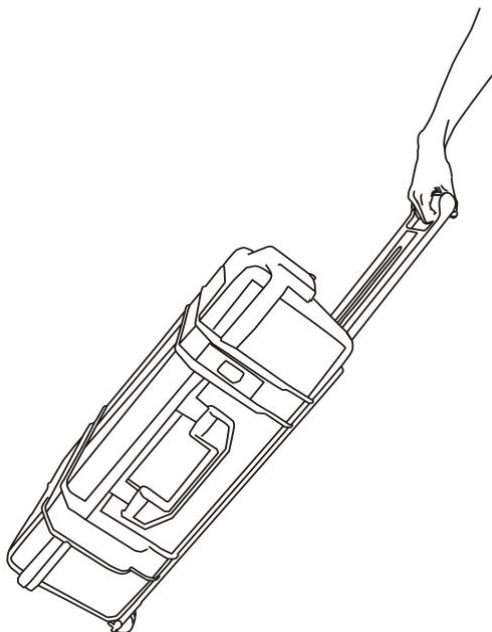

Figure 8.1 Transport by case

Notes

- If the latches are not closed completely, the cover may be open accidentally when lifting the case.
- Do not kick the case or move it with foot.

■ Take the device out of the case

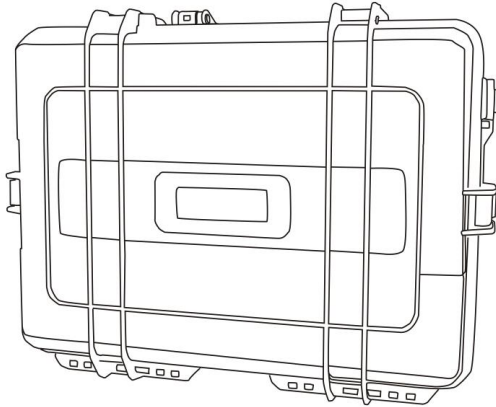

Figure 8.2 Take the device out of the case

Warnings

- Make sure the case cover is completely open before removing the device from the case, to avoid the cover closing suddenly which could result in injury or damage.
- Do not operate the device while it is in the case, to prevent the possibility of the cover closing suddenly which could result in personal injury or damage to the cables.

Notes

- Put the case on a level surface to keep it steady.
- Please loosen the latches on the front of the case to open the cover.
- Do not use force to remove the insert tube out of the groove pad. This may

result in damage to the insert tube.

- Do not pull the device by the insert tube or cables to remove from case.
- Check if the insert tube, device monitor and the quick couplings of the operating handle are clean, if there is dust or dirt, please clean it with a clean soft cloth before use.

8.2 Installation of host

The device monitor can be placed in two ways: by supporter or hanging the handle.



Figure 8.3 Device monitor placed by supporter

Notes

- Place device monitor horizontally and keep it steady.
- Do not position the device monitor in locations where it could be damaged by falling.
- If hanging the host, please make sure it can support its weight.

8.3 Power supply

■ Open the battery cover

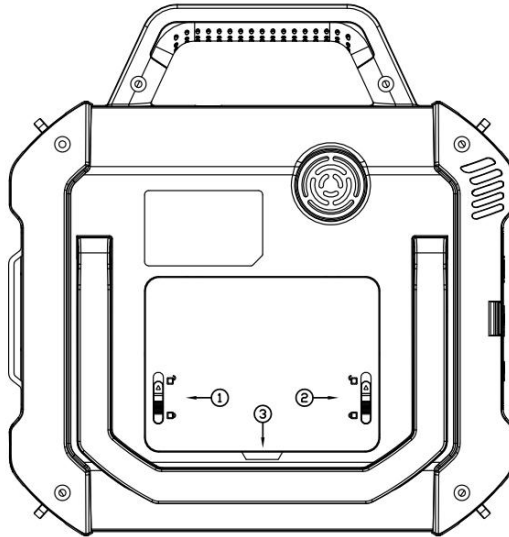



Figure 8.4 Open the battery cover

- 1) Push the slide key of ① shown in the diagram to the unlocking position .
- 2) Push the slide key of ② shown in the diagram to the unlocking position , and hold it.
- 3) Pull the ③ shown in the diagram with hand to open the battery cover.

■ **Load the batteries**

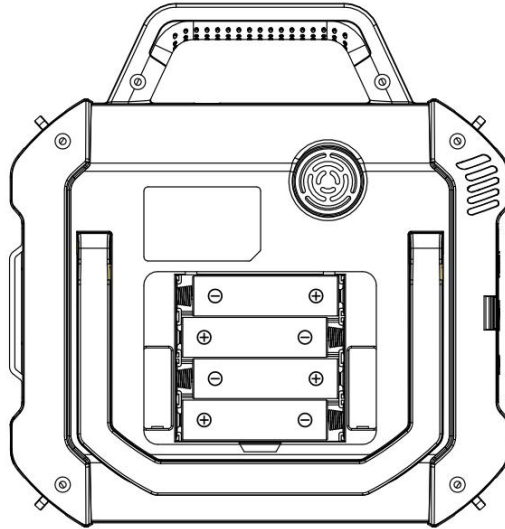

Figure 8.5 Load the batteries

Load 18650 Li batteries into the device in the sequence of positive and negative as shown in the diagram.

⚠ Notes

- The batteries cannot be loaded with wrong positive and negative sequences.
- Four 18650 Li batteries are needed.
- The standard Li batteries provided by Yateks have a circuit protective function. If you need to change the batteries, please select replacements with circuit protective function.

■ Built-in charging

- 1) Take out the adapter, and connect to the DC interface of device monitor.
- 2) Make sure the power supply cable is connected to the DC interface of the device monitor.
- 3) Insert the plug of power supply cable into the power socket properly.
- 4) The red light means it is charging; green light indicates it is fully charged.

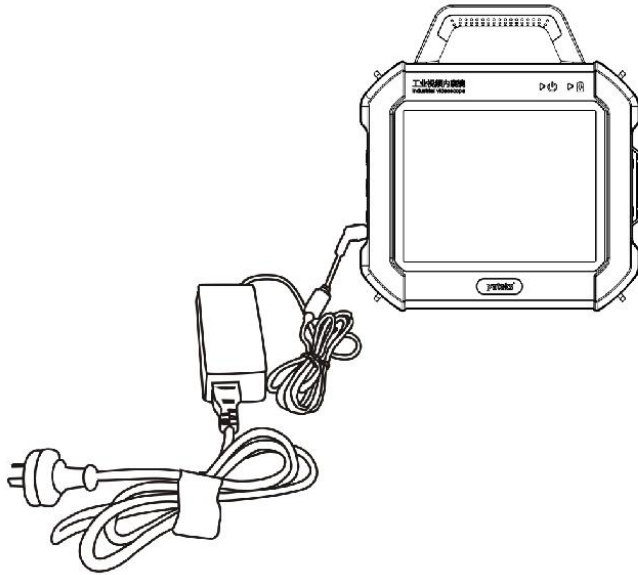

Figure 8.6 Device monitor charging

⚠ Warnings

- Check if the power cable is damaged before use.
- The input voltage of the adapter is 100 - 240 V (50/60 Hz) AC. Use only in properly rated sockets or fire or electric shock may occur.
- Use only the specially provided AC power adapter, otherwise it may cause failure or damage of the device.
- The AC power adapter is not waterproof, and it may cause electric shock if it comes into contact with water.
- Charging input voltage is DC 19V, current is 3.4A.

■ External charging

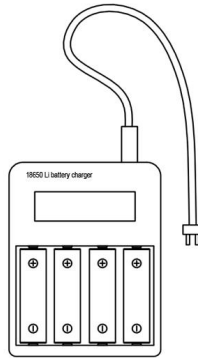

Figure 8.7 External charging

- 1) Load the Li batteries into the charger correctly according to the proper sequence of positive and negative and then connect it with power socket.
- 2) The red light means it is charging; green light indicates it is fully charged.

Notes

- Make sure the batteries are loaded in the right direction.
- Four batteries are independent without mutual interference during the period of charging, and have the functions of anti-overload, anti-overcurrent and anti-short circuit, etc.
- Don't use the device monitor power supply to charge the external charger.

8.4 Inspection of insert tube

■ Visual inspection of insert tube

- 1) Check if the external materials of the whole insert tube and the probe to device monitor cable are complete or not.
- 2) Check if the external covering material of the insert tube (not the articulation part) is loose.

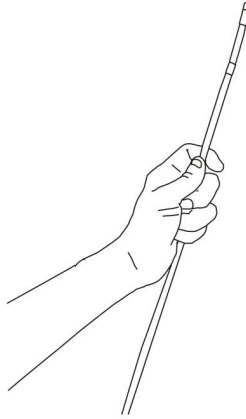

Figure 8.8 Visual inspection of insert tube

⚠ Notes

- If the insert tube becomes deformed, it may become difficult to remove from inserted object.
- If the external material of the insert tube is damaged, please use it with extreme caution to avoid additional damage.

■ Inspection of front end of the insert tube

- 1) Make sure the power is off and disconnected.
- 2) Remove the cap from the front end of the insert tube.
- 3) If there is foreign matter on the lens and the front end of the insert tube, please clean it with a soft cloth, cotton swab or brush.

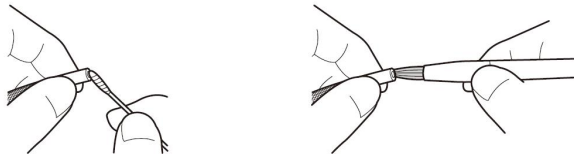

Figure 8.9 Lens cleaning

⚠ Warnings

- The front end of the insert tube will become hot because of the inner heat caused by electrical components. Before cleaning the camera, please cut off the power supply, and wait until it has cooled down before cleaning.

 **Notes**

- Dust or water on the lens will damage the optical adapter and the front end of the insert tube.
- The articulation part consists of precision parts. Please do not drag the front end of the insert tube or push it to bend by hand, this may result in damage to the parts of the articulation part.

8.5 Installing the operating handle on the device monitor.

The operating handle can be installed onto the device monitor as follows:

- 1) Aim the H-shape notch of the operating handle at the U-shape notch of the device monitor; please vertically press the operating handle down into the U-shape notch of the device monitor;
- 2) When removing the operating handle from the device monitor, please vertically lift the operating handle up from the device monitor.

 **Notes**

- If the operating handle is fixed on the side of the device monitor, please hold the handle of the device monitor when carrying. If the operating handle is held to lift the device monitor this may result in the handle pulling away from the device monitor and the monitor will fall.
- While carrying the system in this assembled fashion, make sure to not allow cables to dangle as this may result in them snagging on surrounding objects which may result in damage or injury.
- Place the operating handle onto the device monitor gently to avoid damaging the H-shape notch.

8.6 Connection and removal of the shoulder strap

If you need to carry the device on your shoulder, please connect the shoulder strap. Please note that only the original shoulder strap provided in the kit should be used.

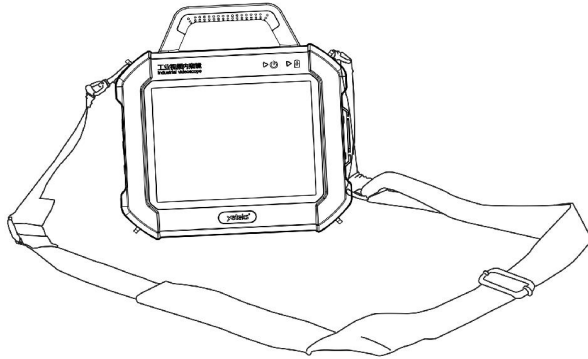

Figure 8.10 Connect the shoulder strap

Warnings

- Never attempt to carry an object other than the device monitor with the shoulder strap. Otherwise, the strap may be damaged and cause the industrial videoscope to fall.
- Be sure to check that the shoulder strap is free of damage before use, such as frayed fibers or damaged clips.
- When using the shoulder strap, be careful not to hit the device against other objects.

Notes

- When placing or removing the shoulder strap, be careful not to drop the device.
- Remove shoulder strap prior to storage in the case as this may result in damage to the LCD or the shoulder strap.
- Do not hang to store the device, otherwise it may damage the strap.
- Check to be sure that the clips of the shoulder strap are securely attached to

the device monitor. Otherwise the device monitor may detach and fall.

■ Placing the shoulder strap

- 1) When pressing the hook lever of the shoulder strap, connect the clips on all four buckles of the device monitor.
- 2) Adjust the length of the shoulder strap using its length adjuster.
- 3) When walking with operating handle installed on the right side of the device monitor, please insert probe to device monitor cable between the handle and the device monitor to prevent snagging the cable.



Figure 8.11 Carrying by the shoulder strap

- 4) When carrying device monitor and handle, you can utilize the cord bundler to keep the cable coiled.



Figure 8.12 Demonstration of holding

■ **Removing the shoulder strap**

To remove the strap, please press and hold the hook lever of the shoulder strap, at the same time, remove the shoulder strap from the buckles of the device monitor.

IX. Basic operations

9.1 Connecting the device monitor and the operating handle

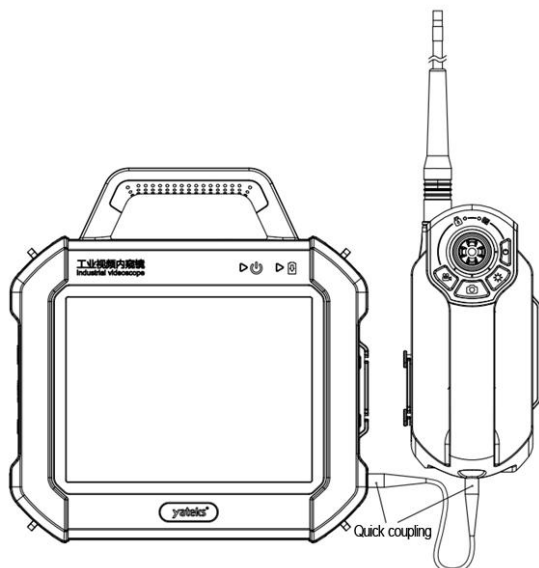

Figure 9.1 The diagram for connecting the device monitor and the operating handle

Notes: Align the red point on the operating handle at the red point on the interface on device monitor as shown in Figure 9.2.

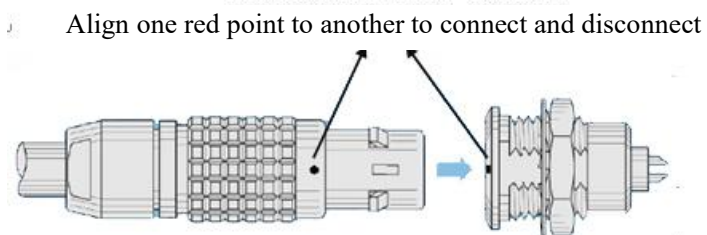

Figure 9.2 Diagram for quick coupling

9.2 Operation instructions for the device monitor

9.2.1 The diagram for the device monitor

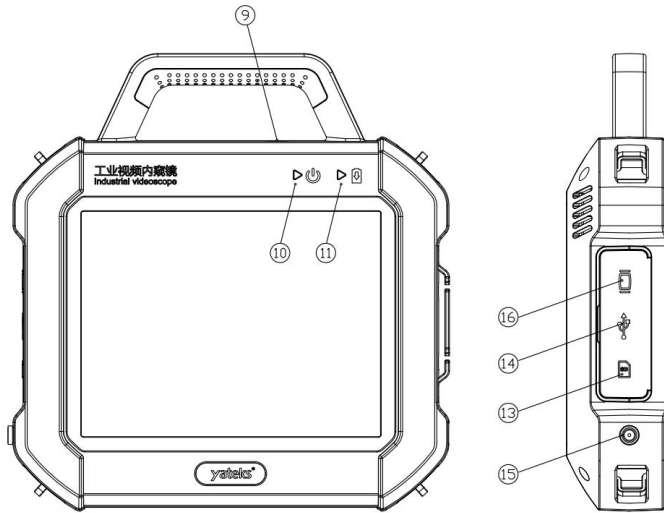

Figure 9.3 The diagram for device monitor

No.	Name	Function
9	Power switch of the device monitor	Control the power supply of the device monitor
10	Power-on indicator	Indicate the power-on
11	Charging indicator	Indicate the charging state
13	SD card connector	Insert the SD card and store the data
14	USB connector	Connect the USB data wire
15	DC connector	Connect the adapter to charge the device monitor
16	HDMI connector	Use the HDMI cable to connect the external monitor

9.2.2 Power-On and Power-Off

- 1) Tap the switch of the device monitor for three seconds. If the power-on

indicator is red, it starts up and loads the program.

2) Enter the home screen after starting up.

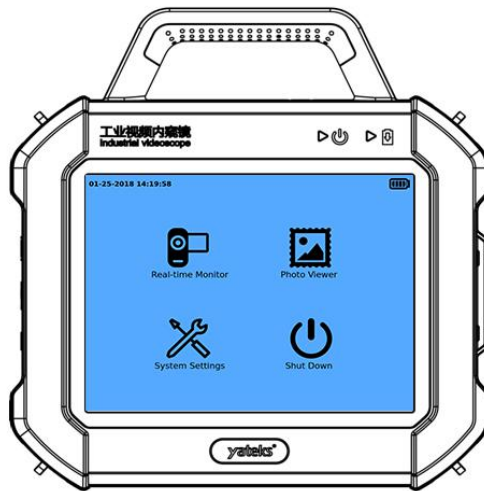

Figure 9.4 Interface of the main menu

3) Click “Shutdown system” and the shutdown selection dialogue box will pop up (as shown in Figure 9.5). Click “Power off” and then the power-on indicator if off. Click “Cancel” and then return the main menu.

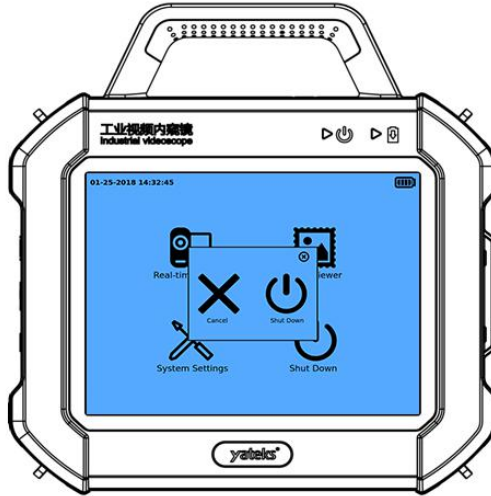

Figure 9.5 Power-off demonstration

⚠ Tips

Tap the power switch on the device monitor, and hold for six seconds and then the system is forced to shut down.

9.2.3 Installing SD card

Press SD card against SD connector and carefully insert it into the card slot.

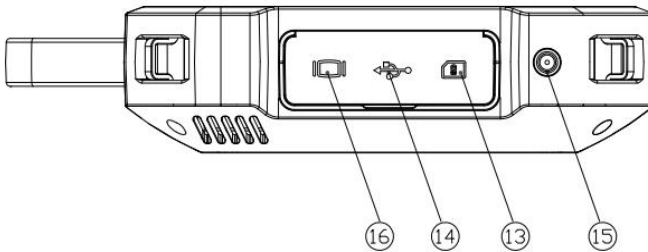





Figure 9.6 Diagram for interfaces

⚠ Notes

- When the SD card is not inserted into the device, the icon on the upper right corner of the display will be changed to  from . The screen will show “SD missing” when taking photo or video.
- When the icon on the right-hand corner is still  after inserting the SD card, wait 15 seconds for the card to register. If no response, the SD card may be inserted incorrectly and needs to be reinserted.

9.2.4 Real-time monitoring

■ Opening and closing the Recording Mode

- 1) Click the icon of “Real-time monitoring” on the home screen and enter the recording mode (as shown in Figure 9.7).



Figure 9.7 Real-time monitoring interface

Tips:

You will be prompted if SD card is set to write-protected, and will only be able to capture photo and video after you’ve unlocked the SD card and reinserted it.

2) Press  to close the recording mode and return the home screen.

■ Taking pictures

Open “Real-time monitoring”, and focus the shot on the objective and adjust it, and then

click  to capture image.

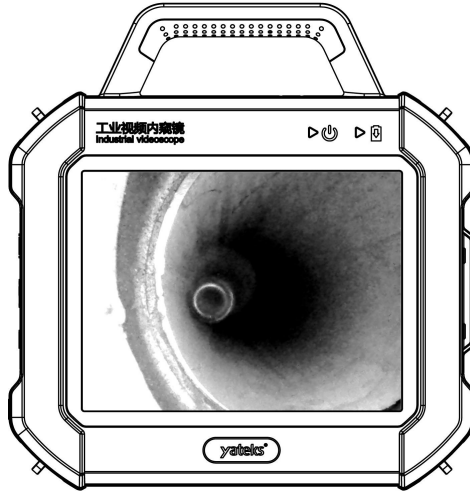



Figure 9.8 Taking photos

Notes



- Insert the SD card before using the recording mode.

■ Shooting videos

Open “Real-time monitoring”, and focus the shot on the objective and adjust

it. Click  to capture video, and then click  to stop shooting and save automatically.

■ Brightness control

The screen brightness is shown on the icon . For example, .

L0~L5 is low brightness control, H0~H5 is high brightness control, 1~5 light up step by step.

■ Viewing Images and Video

1) After shooting pictures and videos, thumbnails will be shown under the

icon . Click the thumbnails to review.

2) Click “Image viewer” on the home screen and enter the picture/video playback.

■ Image locking

Click  icon to lock the images.

■ Image mirror flipping

Click  icon to flip the mirror images.

■ Image white balance

By default, it is auto white balance.

Click “AWB” icon, “√” disappears, the image is set to manual white balance;

Click “AWB” icon, “√” appears, the image is set to auto white balance.

■ Image flipping

Click  icon to flip the images up and down or left and right.

■ Image zoom

Click  icon to zoom in the images step by step. When zooming in to 5x,

click  icon again to switch to 0x.

■ Color setting

Click  icon to set the color mode, as shown in the pic.



Figure 9.9 Color setting

Camera type	2.8mm/PA
	3.9mm/PH
	3.9mm/PG
	6.0mm/YC
	6.0mm/0.45/DL
	6.0mm/QB
	6.0mm/PD
	6.0mm/YF
Color mode	original
	Restore mode

	Short distance mode
	Long distance mode

■ **Return**

Click  icon to return to the main menu interface.

9.2.5 Image viewer

■ **Open and close the photo gallery**

- 1) Click “Image viewer” on the home screen and open the media library (as shown in Figure 9.10). Pictures are sorted by time/date;
- 2) Click “Return” and close the media library to return to the home screen.



Figure 9.10 Open the media library for demonstration

■ **Viewing pictures**







- 1) Open the media library;
- 2) Drag the page up and down to view all the pictures;
- 3) Click the picture thumbnail to view the picture in full screen. For example,

click and open the picture “pic1.jpg” as shown in Figure 9.11.



Figure 9.11 Image viewing demonstration

⚠ Tips:

- 1) Click  to zoom out the picture. And then click  to zoom in the picture.
- 2) Click  or  to view the pictures up and down.
- 3) Click  and then the delete select box will pop up. Click “Yes” to delete the current image and then switch to the next picture; click “No” to return the current image.
- 4) Click  to rename the image (as shown in Figure 9.12). Click  to open the onscreen keyboard. Click “Save” to rename it as the new name entered. Click “Cancel” to return the current image and stop renaming.

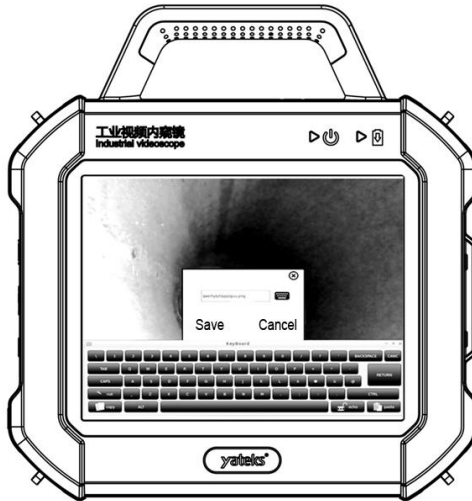



Figure 9.12 Renaming the image

- 5) Click  to return to the media library of thumbnails.

9.2.6 Video viewer







- 1) Open the media library;
- 2) Drag the page up and down to view thumbnails of all the pictures;
- 3) Click the video which will be viewed in the thumbnails. For example, click and open the thumbnail "2. avi" as shown in Figure 9.13;
- 4) Click the play button  to play the current video. The progress bar shows playback schedule. Click  to stop playing.



Figure 9.13 Video playback demonstration

 **Tips:**

- 1) Click  or  to playback the video up and down;
- 2) Click  and then the delete select box will pop up. Click “Yes” and delete the current video and then switch to the next video; click “No” to return the current image.
- 3) Click  to return the media library of thumbnails.

9.2.7 System settings

Click the icon “System setting” on the home screen and then the “System setting” selection box will pop up (Figure 9.14), which includes the options of language setting, time, screen calibration, clean files, software update, system information and exit.



Figure 9.14 System settings

■ Language setting

Click “Language setting” and the “Language setting” selection box will pop up, which includes two languages, Chinese and English.

Click “OK” and then the language of the system is set to the chosen language. After the language is set, the device monitor is automatically restarted. Click “Cancel” to cancel the setting and return the “System setting” selection box.

■ Time correction

Click “Time correction” and the “Time correction” setting box will pop up (as shown in Figure 9.15). Click “+” or “-” to respectively set the year, month, day, hour, minute and second. After setting, click “Save” to save the current setting value. Click “Not save” to cancel and return to the “System settings” selection box.

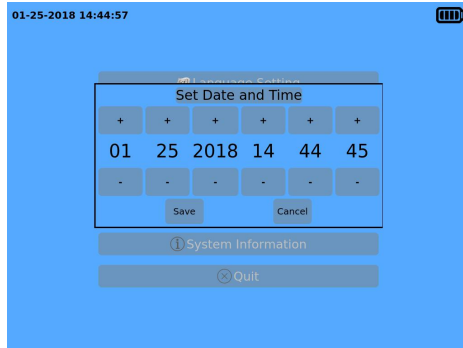

Figure 9.15 Time correction

■ Screen calibration

Click “Screen calibration” and the system calibration interface will pop up (as shown in Figure 9.16). From the left-hand corner, tag the red points in the center of cross for four times. The device monitor will restart automatically after that.

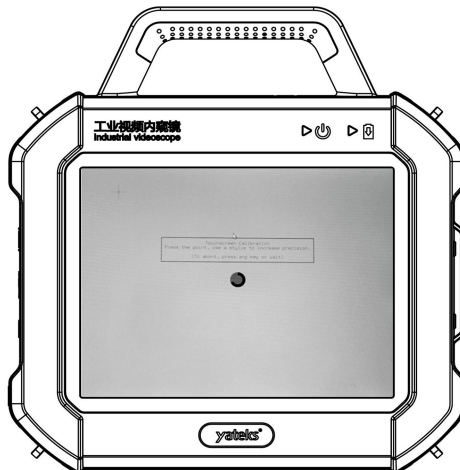

Figure 9.16 Screen calibration

■ Clean files (aka SD Card Formatting)

Click “Clean files” and the “Clean files” selection box will pop up. Click “Start” and the SD card is automatically formatted. Click “Exit” to cancel the setting and return

the “System setting” selection box.

■ Software update

Software update is used to update the software for the customer by Yateks for a long term.

■ System information

Click the icon “System information” on the home screen and then the “System information” description box will pop up, which displays the information of machine processor, video card, running memory, machine storage and SD card storage. Click “Exit” to return to the home screen.

Notes

- Click “Software update” to update the software in the system. After updated, the device monitor will automatically restart and enter the home screen.
- Click “Exit” to return to the home screen.

9.2.8 Demonstrating the touch screen function

The resistive touch screen is included on this device because of its industrial reliability and durability. Any operation (e.g., taking pictures, shooting video) on the host interface can be done by hand or the touch pen.

9.2.9 Data transmission

While SD card is installed on the SD card slot on the left side of the device monitor, pictures and videos will be automatically saved in the SD card. After SD card is removed, its data can be read in a PC by the card reader. In addition, the data line can be used to connect PC and the device under power-on condition so that data in SD card can be read directly or edited.

9.2.10 PC synchronous images

Connect HDMI cable with the LCD and the HDMI connector of the device monitor directly. And then power on the device monitor. It can output the video to the external monitor while simultaneously displaying on the device monitor.

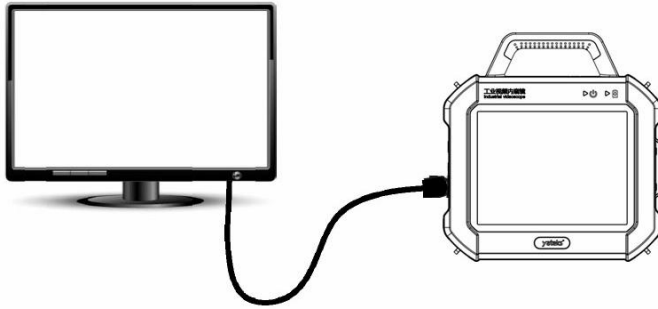

Figure 9.17 Connecting the device monitor and the LCD/External Monitor

 **Notes**

- After connecting HDMI cable, the system needs to be restarted if no video.

9.3 Handle operation guide

9.3.1 Introduction to the operating handle

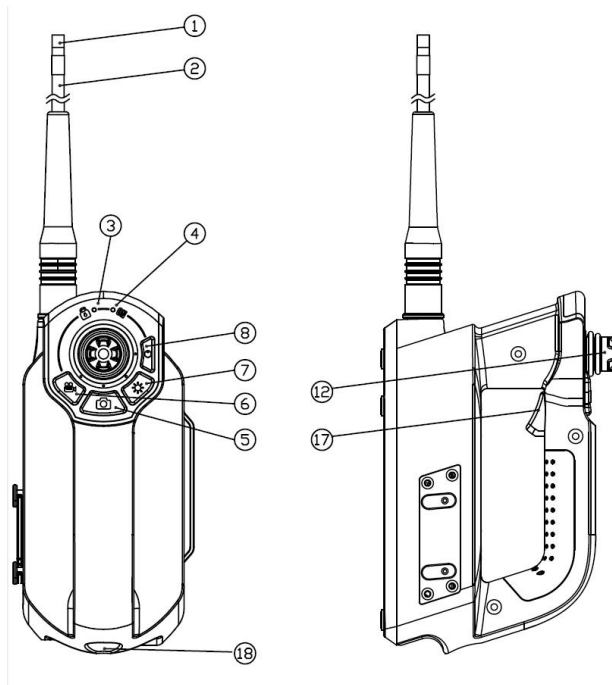



Figure 9.18 The diagram of operating handle

No	Name	Function
3	Locking/tuning indicator	Locking/tuning indicator
4	Power indicator	Indicate the power
5	Capture images/ Dual camera switch	Quick click to capture images/ Hold down to switch dual camera (optional)
6	Capture videos	Capture video
7	Brightness control	Brightness control button has the function of adjusting the LED brightness. There are two

		settings, low brightness and high brightness, which has 5 levels to be selected in all (as shown in Figure 9.22).
8	Locking and tuning	Locking and tuning function of the direction
12	Joystick	Direction control function
18	Quick coupling	Connect with the host

9.3.2 Checking the illuminating lights

- 1) Click the icon “Real-time monitoring” on the home screen to enter the recording mode. Make sure that the brightness indicator  is displayed on the screen.
- 2) The brightness control button has the LED brightness control function to increase the illumination intensity. Tap the brightness control button to check whether LED brightness is changed gradually or not. There are five levels of brightness from dark to brightest, which change step by step.
- 3) The brightness indicator  is located on the display to view the brightness of the insert tube.
- 4) Hold down the brightness control button to switch between low brightness mode and high brightness mode.

Warnings

- When not actively in use, be sure that the brightness of the panel of the host is set to 0 to turn off the light.
- Do not look directly into the light from the end of the rotating axis of the videoscope to avoid affecting your eyesight.

9.3.3 Check the articulation function

- 1) Straighten the insert tube.
- 2) Manipulate the joystick of the operating handle slowly to make sure that the

articulation moves smoothly.

⚠ Note

The articulating movement will match with the angle and direction of the joystick movement.

9.3.4 Check the angle lock and locking and tuning

- 1) Move the joystick to the observing angle and hold for three seconds. If the locking/tuning indicator is green, the angle is automatically locked.
- 2) If it needs to reset the camera, move the joystick at will and then loosen it. The camera is automatically reset and the locking/tuning light of the device goes out.

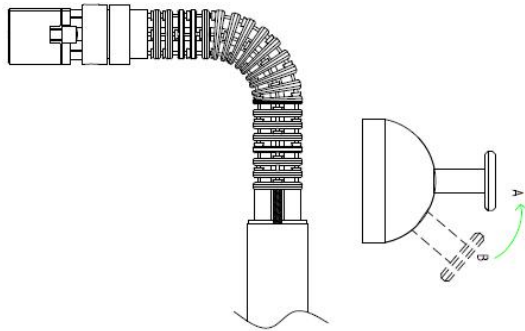

Figure 9.19 Articulation check and locking and tuning

- 3) Based on the locking function, if it needs to fine-tune the direction, directly press the “locking and tuning” button. When the “locking/tuning” indicator is red, the joystick can be moved to fine-tune the direction.
- 4) If it needs to reset the camera, press the “locking/tuning” button again. The camera is automatically reset and the locking/tuning light of the device is off.

⚠ Notes

- When using the locking and tuning function, do not bend or angle the tube by hand as this may result in damage.

9.3.5 Installing optical adapter (only apply to the IL series)

- 1) Check for the presence of dust or moisture in or on the objective lens. If detected, hold tube carefully and remove dust or moisture it with a soft gauze or cotton swab.
- 2) Connect by inserting the optical adapter into the end of the insert tube.

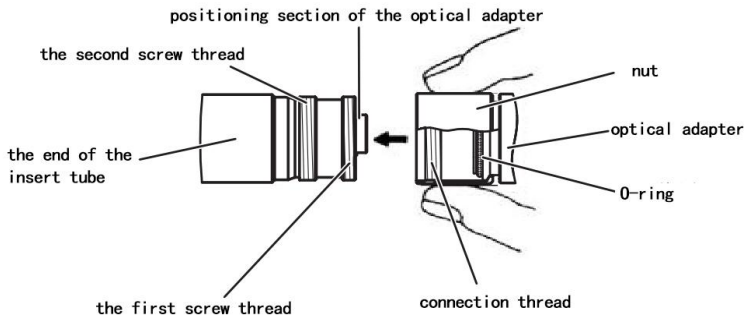

Figure 9.20 Component of the optical part

- 3) Rotate the nut of the optical adapter clockwise until the first screw thread goes through the connection thread.



Figure 9.21 Optical adapter

- 4) Once going through the first screw thread, please rotate the whole optical adapter clockwise until it is fully tightened.

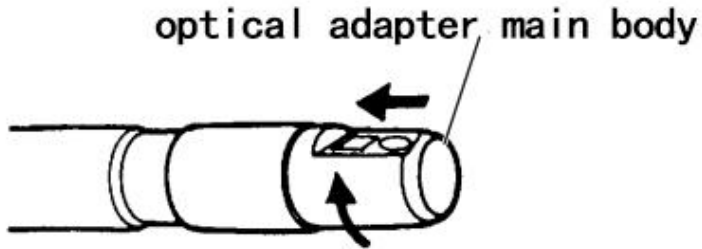

Figure 9.22 Optical adapter main body

9.3.6 Inserting the insert tube

■ Holding the control unit and insert tube

- 1) In general, the joystick of the operating handle is manipulated with the thumb of the hand.
- 2) Other buttons are also to be manipulated with the thumb of the hand pressing the button of the operating handle.

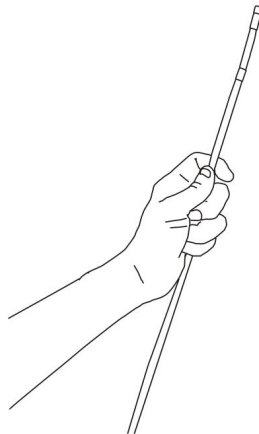

Figure 9.23 Handle manipulation

■ Inserting the insert tube

- 5) While referring to the monitor display, carefully check the insert tube and

slowly insert the tube into the observed object. Perform the articulation operation as required during insertion. Be careful not to apply excessive pushing force, twisting or tension to the insert tube.

- 6) While withdrawing the insert tube, be sure that the front end of the insert tube is in the straight direction (the joystick is in the middle) and then withdraw it slowly.

■ Manipulating the articulation

- 1) Manipulate the joystick to control the articulation of the front end to make the observation easy as required by the on-site testing.
- 2) Adjust LED brightness to receive the proper brightness so as to achieve the clearest picture effect.

⚠ Notes

- 1) If the articulation control mechanism stops or the operation of the device is abnormal, please stop the operation immediately. Loosen the joystick to make it automatically reset to the central position. And withdraw the insert tube from the observed object carefully.
- 2) If a sharp noise occurs inside of the controls of the device when moving the joystick, do not bend it further.
- 3) Always manipulate the joystick slowly and gently.
- 4) The repeated articulation operation will decrease the maximum articulation angle limit of the articulation section. Keep the insert tube straight as often as possible to achieve the best functionality of the device.
- 5) Do not operate the joystick or attempt to articulate the camera head until the cable has been uncoiled and is fully straightened.

9.3.7 Withdrawing the insert tube

- 1) Release the articulation lock.
- 2) Withdraw the insert tube.

Warnings

- Do not withdraw the insert tube while articulation is engaged. Always straighten the end of the tube before beginning to withdraw. Otherwise it might damage the insert tube and/or the object it is inserted into.
- After use in a high temperature environment, the end of the insert tube may be very hot. Do not use or reinsert until you've allowed it to cool.
- If the insert tube is stuck in the withdrawing process, gently steer the joystick, while continuing to withdraw it. Do not use excessive force to avoid damaging the insert tube or the observed objects.

9.3.8 Introduction to the operating handle button

■ Direction joystick

The joystick can control the 360 degree steering and locking function of the camera of the videoscope in real time. If you need to articulate during inspection, you can move the joystick to the observing angle and hold for three seconds to lock into position, if the locking indicator is green, the angle is locked automatically. If you needs to reset the camera, move the joystick at will and then loosen it. The camera is automatically reset and the device indicator goes off.

■ Brightness adjustment

The brightness adjustment button has the LED brightness control function. There are two regulating modes to select - low brightness and high brightness which can be switched by holding the brightness adjustment button down (as shown in Figure 9.24).

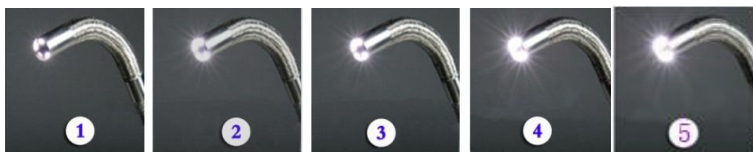

Figure 9.24 LED brightness control demonstration

■ Capturing images

The camera button provides the function of capturing images. Tap the camera button to capture images.

■ Capturing video

The video button provides the video capture function. Tap the video button to capture live video.

■ Indicator

- 1) Locking/tuning indicator of the direction joystick; the locking indicator is red, while tuning is green.
- 2) Power indicator is red when it is working.

■ Interface for connecting to the device monitor

Quick coupling to connect with the device monitor.

■ Locking and tuning

As for the tuning control function of the direction, when it enters the tuning function, "locking/tuning" indicator is red. Tap the [Locking/tuning] button again, the indicator goes out. The angulation lock is unlocked. The angle returns to the initial position.

X Storage and maintenance

10.1 Cleaning

■ Cleaning the insert tube

- 1) Use a lint free cloth to wipe any dirt or other foreign matter off of insert tube.
- 2) If a liquid such as waste water or machine oil is attached to the insert tube, it requires the following further cleaning steps: ① Wipe it with a soft cloth or cotton swab, ② Clean thoroughly by using a neutral detergent solution and pieces of gauze, ③ Wipe it with a piece of soft gauze moistened with clean water, ④ Wipe off and dry thoroughly.

Notes

- Clean the scope immediately after withdrawing the insert tube.
- Do not clean the optical adapter under running water as the device may be damaged.
- Keep the device on a horizontal flat surface and store it at room temperature in a clean dry environment.
- Take care when transporting and storing the device even when it is secured in the storage case. Do not drop or hit the storage case.
- If the device isn't used for long periods of time, check its functions regularly.

Warnings

- The device should be kept out of reach of children and only operated by an experienced user.
- Do not store the equipment in a place subject to high temperature, high humidity, intense light, excessive dust or particles, strong shock or hazardous environments.

■ Cleaning LCD

If the LCD is dirty or contains fingerprints, wipe it with the lint free soft cloth.

■ Cleaning the device monitor and the operating handle

If the device monitor or case is dirty, wipe it with the lint free soft cloth.

Notes

- Do not clean the equipment under running water as this may damage the device.

10.2 Repacking the case

Replace the operating handle before packing the device monitor in the case.

Notes

- 1) Store the operating handle, insert tube and device monitor in the right order.

Otherwise, it may damage the insert tube.

- 2) Do not use excessive force when placing the insert tube into the groove of the case. Otherwise, the insert tube may be damaged.
- 3) Ensure that the insert tube won't be bent when storing.
- 4) Make sure that the case latches are properly locked. If not, the top cover may open during transport.
- 5) When returning the device monitor to its case, place the case on a level surface before repacking the equipment.
- 6) Use only the standard case provided by InterTest. Otherwise, the operating handle or the device monitor may be damaged or fail.

■ Securing the case

Always ensure case is fully closed before transporting.

Note: Secure the four latches of the case.

Storage precautions

- 1) Store the equipment under the normal room temperature and humidity.
- 2) Turn off the power of the device before packing.
- 3) Store the equipment on a clean, dry and even surface.

Danger

Do not bend, stretch, twist or crush the probe to device monitor cable with excessive force. Otherwise, a break in a cable may cause a fire or electric shock hazard.

Notes

- 1) Do not store the equipment in a place subject to high temperature, high humidity, excessive dust or fine particles, direct sunlight or radioactive emissions. Otherwise it could damage the equipment.
- 2) Handle it gently when storing. Do not hit it against other objects. Otherwise it could cause a failure.

XI. Troubleshooting

Please contact InterTest if you are unable to resolve an issue by referring to the following guide, and discontinue use of the device until proper service has occurred if:

- ① Inspect the equipment as described in Chapter 8 indicates a serious problem.
- ② If the problem cannot be solved by referring Chapter 11.1.

11.1 Troubleshooting guide

Failure	Possible cause	Solutions
The system cannot be turned off.	Pause or halt occurs incidentally to the system.	Hold the the on-off button down on the device monitor and hold for six seconds to restart it.
Video playback	It can't play the video of AVI format.	It can be played by using the VLC media player or QQ Player.
Pictures and videos cannot be recorded	SD card is full or isn't inserted	Delete the files in SD card or insert the SD card
No card is still shown after the insertion of the SD card	The SD card is not properly inserted	Remove and reinsert the SD card firmly into slot.
Shut down automatically	The device is used in the environment of high temperature will trigger the automatic shutdown.	Terminate the inspection to cool the device down. And then restart it.
	The low battery power will trigger the automatic shutdown.	Charge the battery
The image is not sharp.	The object lens on the videoscope end or the optical adapter is dirty.	Wipe it with a clean piece of gauze or cotton swab.

The operating handle emits squeak or squeal when in use	This is likely motor noise	Some noise is normal during operation.
The load is increasingly strenuous when the articulation is manipulated	Articulation control motor overloads.	Stretch the insert tube as far as possible to reduce the looping amount.
The articulation can't return to the initial position.	Set up the articulation locking	Move the joystick in any way to release the articulation locking.
	The locking and tuning function might be entered. At this time "Locking/tuning" indicator is red.	Press "Locking/tuning" button again and then the "Locking/tuning" indicator goes out and the articulation locking is released. The angle returns to the initial position. It will reposition to initial position.

11.2 Returning the device for repair

- 1) Before returning the equipment for repair, contact InterTest for service. Please provide the issue and a detailed description of the conditions under which it occurs when returning the device.
- 2) Failures that occur during the warranty period are repaired at no charge according to the warranty agreement. Be sure to attach the warranty agreement when returning the device for repairs.
- 3) No parts of this device are designed for self-repair. Do not attempt to alter or repair. InterTest does not accept any responsibility for damage or injury caused by these circumstances. The repair service of this product is only offered by Yateks and its authorized repair center – InterTest.

InterTest, Inc.
303 Route 94
Columbia, New Jersey 07832
Tel: 908-496-8008
Fax: 908-496-8004
<https://intertest.com>
E-mail: info@intertest.com

