

Color Camera Module

Technical Manual



FCB-EV9500L

Table of Contents

- Features..... 3**
- Precautions 4**
- Locations of Controls 6**
- Basic Functions 7**
 - Overview of Functions..... 7
 - Firmware Update 22
 - Eclipse..... 25
 - Spectral Sensitivity Characteristics 25
 - Initial settings and backup of camera 26
 - Mode Condition 28
- Command List..... 31**
 - VISCA/RS-232C Commands 31
 - FCB Camera Commands 37
- Specifications 57**
- Note on the License 73**

Features

- **Imager**

This camera uses a 1/1.8" STARVIS™ CMOS (complementary metal-oxide semiconductor) image sensor (approx. 4.17 million effective pixels) that supports high definition to produce high-quality images.

- **ISP**

Using the image signal processor (ISP), the following images can be obtained.

- Full HD 60fps output image

The following functions are provided.

- Noise Reduction (NR)
- Wide Dynamic Range Mode (Wide-D),
Visibility Enhancer (VE), and Defog
- Super+ Image Stabilizer

With consideration given environmental protection, this module incorporates lead-free and halogen-free circuit boards.

Precautions

Software

Use of the demonstration software developed by Sony Corporation or use of the software with customer developed application software may damage hardware, the application program or the camera. Sony Corporation is not liable for any damages under these conditions.

Operation

Start the camera control software on your computer after you turn on the camera and the image is displayed.

Operation and storage locations

Do not shoot images that are extremely bright (e.g., light sources, the sun, etc.) for long periods of time. Do not use or store the camera in the following extreme conditions:

- Extremely hot or cold places (operating temperature -5°C to $+60^{\circ}\text{C}$ (23°F to 140°F))
- Close to generators of powerful electromagnetic radiation such as radio or TV transmitters
- Where it is subject to fluorescent light reflections
- Where it is subject to unstable (flickering, etc.) lighting conditions
- Where it is subject to strong vibration
- Where it is subject to radiation from laser beams

Care of the unit

Remove dust or dirt on the surface of the lens with a blower (commercially available).

Other

- Design and specifications are subject to change without notice.
- Do not apply excessive voltage. (Use only the specified voltage.) Otherwise, you may get an electric shock or a fire may occur.
- The CMOS image sensor and IC included in this camera may break if exposed to static electricity. When directly handling this camera, wear an antistatic strap, spread a conductive sheet or similar item under your workbench, and take measures to eliminate static electricity.

- In case of abnormal operation, contact your authorized Sony dealer or the store where you purchased the product.

Handling precautions

- When handling this unit, be careful not to apply an excessive load to all portions of the unit except for the sheet-metal cover. Otherwise, it may result in a failure.
- This unit is designed to be built in the housing. Therefore, take measures to prevent the unit from receiving the intense light such as sunlight directly from the direction other than the front side. Otherwise, it may cause the image quality degradation.

Phenomena specific to CMOS image sensors

The following phenomena that may appear in images are specific to CMOS image sensors. They do not indicate malfunctions.

Rolling shutter

As CMOS image sensors use shutters that capture images line-by-line, there is a slight time difference between the top and bottom of an image. As a result, images may appear skewed if the camera is moved.

White flecks

Although the CMOS image sensors are produced with high-precision technologies, fine white flecks may be generated on the screen in rare cases, caused by cosmic rays, etc.

This is related to the principle of CMOS image sensors and is not a malfunction.

The white flecks especially tend to be seen in the following cases:

- when operating at a high environmental temperature
- when you have raised the gain (sensitivity)
- when operating in Slow-Shutter mode

Aliasing

When fine patterns, stripes, or lines are shot, they may appear jagged or flicker.

Notes on incorporating a camera

When incorporating a camera on a device that turns ON/OFF 3 times or more a day on average, please confirm the temperature in the set using communication command 'CAM_TempInq' (VISCA). Please release heat until the increased temperature inside the set at the moment the set turns on reduces until it is stable at 12 °C or below.

Phenomena Specific to Lenses**Ghosting**

If a strong light source (e.g., the sun) exists near the incidence angle of the lens, bright spots may appear in the image due to diffuse reflection within the lens.

About the trademark

STARVIS™ and “StableZoom” are trademarks of Sony Group Corporation or its affiliates.

Locations of Controls

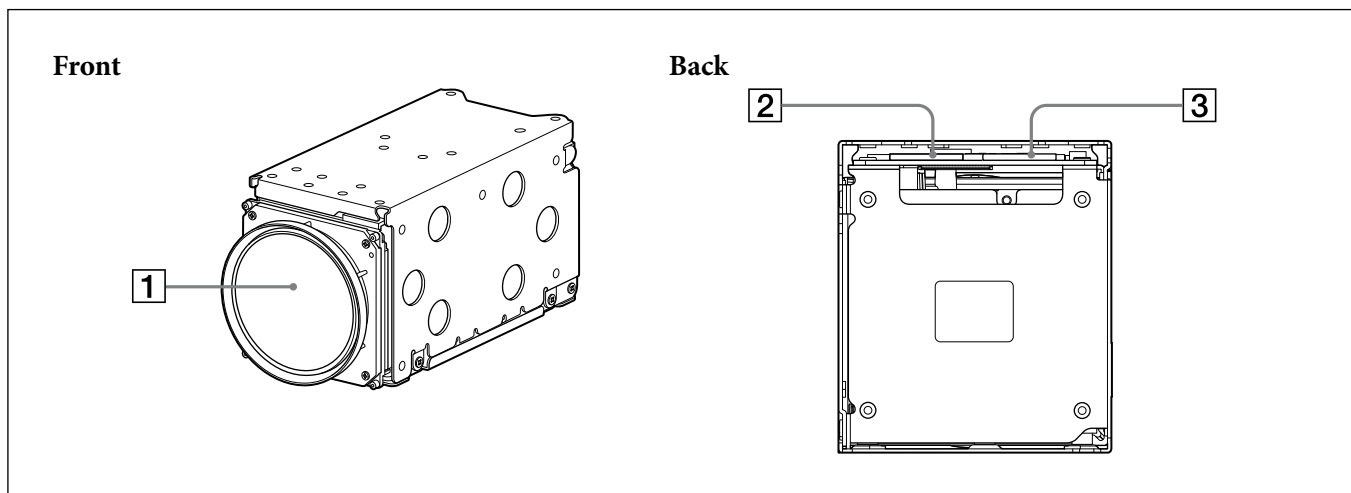

1 Lens

2 Maintenance connector

* Do not connect here, this is for maintenance purpose.

3 Digital output connector

Basic Functions

Overview of Functions

The camera control is performed by VISCA Commands.

Timing Chart

As VISCA Command processing can only be carried out one time in a Vertical cycle, it takes the maximum 1V cycle time for an Acknowledge/Completion to be returned.

If the Command/Acknowledge/Completion communication time can be less than the 1V cycle time, then every 1V cycle can receive a Command.

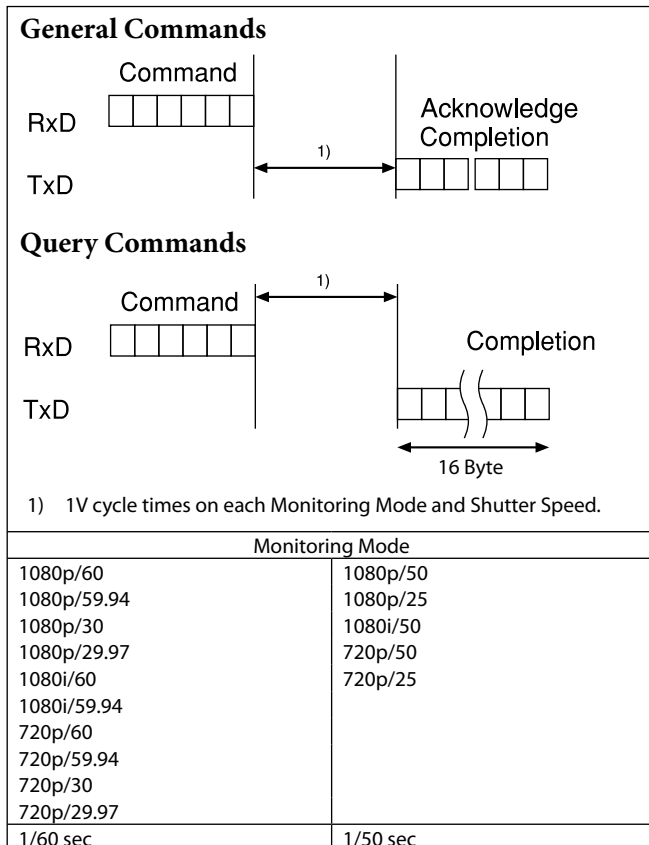

In general

- **Power On/Off (Standby)**

Powers the camera on and off.

When the power is off (on Standby), the camera is able to accept the VISCA Commands although the screen is set non-displayed.

- **I/F Clear**

Clears the Command buffer of the FCB camera.

- **Address Set**

VISCA is a protocol, which normally supports a daisy chain of up to seven connected cameras via RS-232C interface. In such cases, the address set command can be used to assign addresses from 1 to 7 to each of the seven cameras, allowing you to control the seven cameras with the same personal computer.

Although the FCB camera does not support direct connection of cameras in a daisy chain, be sure to use the address set command to set the address whenever a camera is connected for the first time.

- **ID Write**

Sets the camera ID.

- **Mute**

Blanks the screen and sends out a synchronizing signal.

- **Lens Initialize**

Initializes the zoom and focus of the lens. Even when power is turned on, it initializes the zoom and the focus.

Video Output

This camera can output two types of videos, FHD output / HD output.

• FHD output / HD output

This can video output the Monitoring Mode as shown in the table below. The video interface is the LVDS (Low Voltage Differential Signaling).

Monitoring Mode	
1080p/60	1080p/50
1080p/59.94	1080p/25
1080p/30	1080i/50
1080p/29.97	720p/50
1080i/60	720p/25
1080i/59.94	
720p/60	
720p/59.94	
720p/30	
720p/29.97	
1/60 sec	1/50 sec

Zoom

The zoom function contains 2 functions, enhanced optical zoom and digital zoom.

• Enhanced optical zoom

Zoom function that enlarges the image by moving the zoom lens while changing the effective pixel area of the image sensor.

This can zoom up to 30 \times .

• Digital zoom

The function to zoom images digitally by cropping the center part of captured images to zoom with the CMOS image sensor.

When the zoom diameter goes up, the resolution will go down. This can zoom up to 12 \times .

When StableZoom is used, the unit can zoom up to 432 \times .

Zoom has the following modes.

Using Standard Mode

Using Variable Mode

There are eight levels of zoom speed.

Notes

- The zoom will be stopped when a Stop Command is sent after the zoom operation is started in Standard Mode or Variable mode. If you do not send a Stop Command, the zoom will be stopped after reaching the Wide end or the Tele end.
- The StableZoom and Zoom Separate mode do not work at the same time. When one function is ON, the other function cannot be turned ON.

Direct Mode

Setting the zoom position enables quick movement to the designated position.

Digital Zoom

The Zoom Mode supports, a OFF, a Combined Mode and a Separate Mode.

Combined Mode

This is the previously existing zoom method. After the enhanced optical zoom has reached its maximum level, the camera switches to Digital Zoom Mode.

Separate Mode

In this mode, Enhanced Optical Zoom and Digital Zoom can be operated separately. You can use digital zoom magnification at any time from within any level of optical magnification.

Note

When you operate Direct Mode Digital Zoom
When the Digital Zoom is operated in the Direct Mode, the Direct Zoom Position of the Inquiry Command is not immediately reflected. Place a wait time before reading the position.
When using the Slow Shutter, place a wait time more than twice the shutter speed.
When not using Slow Shutter, place a wait time of 0.1 seconds or more.

About Continuous Zoom Position Reply

With ZoomDirect mode, or when zooming according to a preset, the camera outputs zoom position data when Continuous Zoom Position Reply is set to On via a command.

Continuous Zoom Position Reply: y0 07 04 69 0p 0p 0q 0q 0q 0q FF

pp: D-Zoom Position

qqqq: Zoom Position

Focus

Focus has the following modes.

• Auto Focus Mode

The Auto Focus (AF) function automatically adjusts the focus position to maximise the high frequency content of the picture in a center measurement area, taking into consideration the high luminance and strong contrast components. The minimum focus distance is 100 mm at the Wide end and 1200 mm at the Tele end.

- Normal AF Mode

This is the normal mode for AF operations.

- Interval AF Mode

The mode used for AF movements carried out at particular intervals. The time intervals for AF movements and for the timing of the stops can be set in one-second increments using the Set Time Command. The initial setting for both is set to 5 seconds.

- Zoom Trigger Mode

When zoom position is changed, it becomes AF mode during the pre-set value (initial setting is set to 5 seconds). Then it stops.

• AF Sensitivity

The switching of AF sensitivity can be set.

- Normal

Reaches the highest focus speed quickly. Use this when shooting a subject that moves frequently. Usually, this is the most appropriate mode.

- Low

Improves the stability of the focus. When the lighting level is low, the AF function does not take effect, even though the brightness varies, contributing to a stable image.

• Manual Focus Mode

Manual Focus has both a Standard Mode and a Variable Mode. Standard Mode focuses at a fixed rate of speed. Variable Mode has eight speed levels.

Note

In these standard and variable modes, it is necessary to send Stop Command to stop the zoom operation.

• One push AF

When sending a One Push Trigger command in Manual Focus Mode, the lens moves to focus on the subject. After that, it will convert to the normal Manual Focus Mode.

There are two kinds of One Push Trigger commands.

- One Push Trigger

As with the Auto Focus, move the focus smoothly and focus on the subject.

- Full Scan One Push Trigger

Perform a Full Scan (move the focus to the whole area from the Near end to the Far end), and focus on the subject after confirming the distance with the subject.

Unlike the One Push Trigger, the time to focus is longer because of full scan operation, but you can focus more accurately.

• Near Limit

Can be set in a range from 1000 (∞) to F000 (100 mm). Initial setting: D000h (33 cm)

• Spot Focus

Spot Focus allows you to focus on a specific area.

You can use Spot Focus when it is difficult to focus on the subject using normal AF mode.

The focus range of 6 blocks vertically and 8 blocks horizontally can be designated.

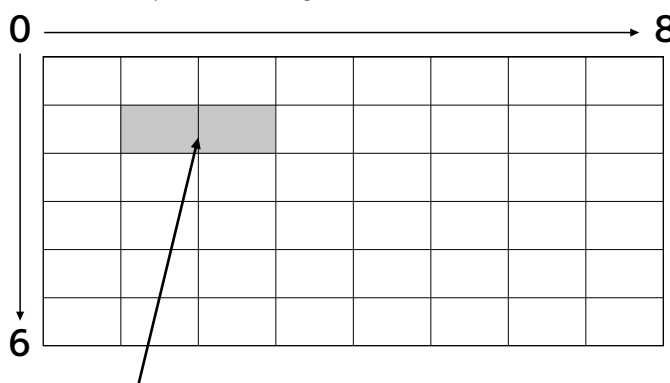

When specifying this part, specify it at the starting point (1,1) and the terminating point (3,2) or at the starting point (1,2) and the terminating point (3,1). Be sure to specify at the diagonal position.

Spot Light Avoidance

When shooting a subject with a spot light source such as an outdoor light, the camera may not be in focus due to AF / One push AF.

For example, when shooting outdoors at night with a surveillance camera, this symptom is likely to occur. In that situation, using the Spot Light Avoidance function, you can focus with the AF / One push AF.

• Example of subject that can be focused by the Spot Light Avoidance

Spot Light Avoidance OFF

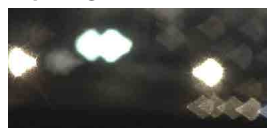

Spot Light Avoidance ON

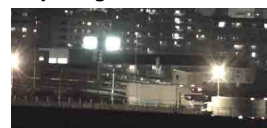

Note

Depending on the zoom ratio and the brightness of the spotlight, this function may not be effective.

White Balance (WB)

White Balance has the following modes.

- **Auto**

This mode computes the white balance value output using color information from the entire screen. It outputs the proper value using the color temperature radiating from a black subject based on a range of values from 2500K to 7500K.

This mode is the initial setting.

- **ATW**

Auto Tracing White balance (2000K to 10000K)

- **Indoor**

3200K Base Mode

- **Outdoor**

5800K Base Mode

- **One Push WB**

The One Push White Balance mode is a fixed white balance mode that may be automatically readjusted only at the request of the user (One Push Trigger), assuming that a white subject, in correct lighting conditions, and occupying more than 1/2 of the image, is submitted to the camera.

One Push White Balance data is lost when the power is turned off. If the power is turned off, reset One Push White Balance.

- **Manual WB**

This is a mode that enables you to manually set the control of R and B gain up to 256 steps.

- **Outdoor Auto**

This is an auto white balance mode specifically for outdoors. It allows you to capture images with natural white balance in the morning and evening.

- **Sodium Vapor Lamp Auto**

This is an auto white balance mode that is compatible with sodium vapor lamps.

- **Sodium Vapor Lamp**

This is a fixed white balance mode specifically for sodium vapor lamps.

- **Sodium Vapor Lamp Outdoor Auto**

This is an auto white balance mode specifically for outdoors, which is compatible with sodium vapor lamps.

Note

High-pressure sodium lamps are supported. Proper white balance may not be captured for some subjects when using low-pressure sodium lamps.

- **Spot AWB**

Spot AWB allows you to focus on a specific area and adjust the white balance.

The AWB range of 6 blocks vertically and 8 blocks horizontally can be designated.

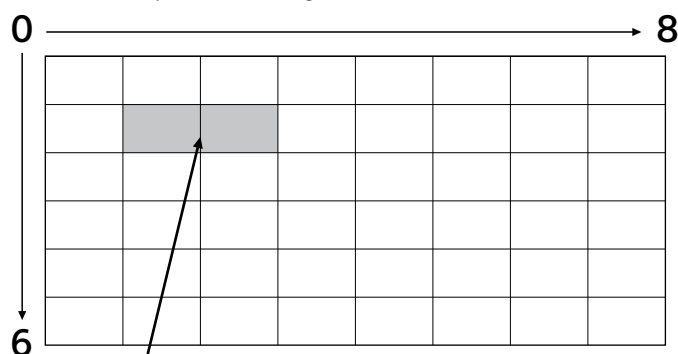

When specifying this part, specify it at the starting point (1,1) and the terminating point (3,2) or at the starting point (1,2) and the terminating point (3,1). Be sure to specify at the diagonal position.

Auto Exposure Mode (AE)

A variety of AE functions are available for optimal output of subjects in lighting conditions that range from low to high.

- **Full Auto**

Iris, Gain and Shutter Speed can be set automatically.

- **Gain Limit Setting**

The gain limit can be set in AE Mode Full Auto, Shutter Priority, Iris Priority, and Spot AE. Use this setting when you want to obtain image in which signal-to-noise ratio is particularly important.

- **Shutter Priority**

Adjust with Variable Shutter Speed (1/1 to 1/10,000 sec., 16 high-speed shutter speeds plus 6 low-speed shutter speeds), Auto Iris and Gain.

- **Iris Priority**

Adjust with Variable Iris (F1.6 to F14, 13 steps), Auto Gain and Shutter speed.

- **Manual**

Adjust with Variable Shutter, Iris and Gain.

AE – Shutter Priority

The shutter speed can be set freely by the user to a total of 22 steps – 16 high speeds and 6 low speeds. When the slow shutter is set, the speed can be adjusted according to subject brightness. The picture output is read at a normal rate from the memory. The memory is updated at a low rate from the CMOS. AF following capability is lowered and also the number of frame to be displayed is decreased. In high speed mode, the shutter speed can be set up to 1/10,000s. The iris and gain are set automatically, according to the brightness of the subject.

Data	59.94/29.97 mode	50/25 mode
15	1/10000	1/10000
14	1/6000	1/6000
13	1/4000	1/3500
12	1/3000	1/2500
11	1/2000	1/1750
10	1/1500	1/1250
0F	1/1000	1/1000
0E	1/725	1/600
0D	1/500	1/425
0C	1/350	1/300
0B	1/250	1/215
0A	1/180	1/150
09	1/125	1/120
08	1/100	1/100
07	1/90	1/75
06	1/60	1/50
05	1/30	1/25
04	1/15	1/12
03	1/8	1/6
02	1/4	1/3
01	1/2	1/2
00	1/1	1/1

AE – Iris Priority

The iris can be set freely by the user to 13 steps between F1.6 and F14.

The gain and shutter speed are set automatically, according to the brightness of the subject.

Data	Setting value	Data	Setting value
11	F1.6	0A	F5.6
10	F2	09	F6.8
0F	F2.4	08	F8
0E	F2.8	07	F9.6
0D	F3.4	06	F11
0C	F4	05	F14
0B	F4.8		

AE – Manual

The shutter speed (22 steps), iris (13 steps) and gain (15 steps) can be set freely by the user.

Spot AE

In Full Auto AE, the level for the entire screen is computed and the optimum Auto Iris and Gain levels are determined. In Spot AE, a particular section of the subject can be designated, and then that portion of the image can be weighted and a value computed so that Iris and Gain can be optimized to obtain an image. For example, in an image with a lot of movement and with varying levels of brightness, portions without much change can be designated as such a “spot,” and changes to the screen can be minimized in that area. As shown in the diagram below, a range of 6 blocks vertically and 8 blocks horizontally can be designated.

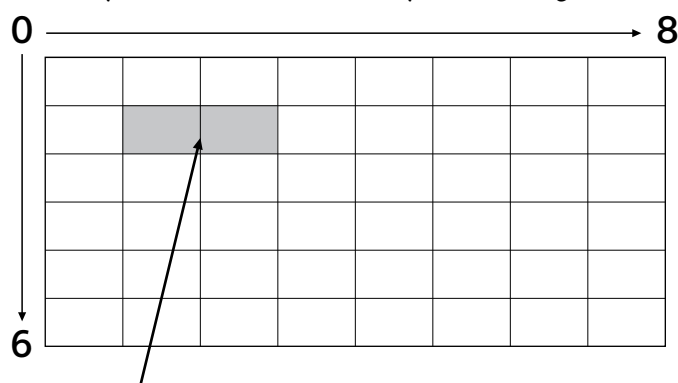

When specifying this part, specify it at the starting point (1,1) and the terminating point (3,2) or at the starting point (1,2) and the terminating point (3,1). Be sure to specify at the diagonal position.

Notes

- Wide-D/HLC/Backlight Compensation does not work at the same time with Spot AE.
- The Slow AE function does not work while the Spot AE mode is turned ON.

Exposure Compensation

Exposure compensation is a function which offsets the internal reference brightness level used in the AE mode, by steps of 1.5 dB.

Data	Step	Setting value
0E	+7	+10.5 dB
0D	+6	+9 dB
0C	+5	+7.5 dB
0B	+4	+6 dB
0A	+3	+4.5 dB
09	+2	+3 dB
08	+1	+1.5 dB
07	0	0 dB
06	-1	-1.5 dB
05	-2	-3 dB
04	-3	-4.5 dB
03	-4	-6 dB
02	-5	-7.5 dB
01	-6	-9 dB
00	-7	-10.5 dB

Slow AE (Auto Exposure)

The slow AE Response function allows you to reduce the exposure response speed. Usually the camera is set up so that the optimum exposure can be obtained automatically within about 1 second. However, using the slow AE response function allows you to lengthen the auto exposure response speed from the initial setup speed (01h) to approx. 10 minutes (30h) (at normal shutter speed).

For example, with the normal setting (about 1 second), if the headlights of a car are caught by the camera, the camera automatically adjusts the exposure so that it can shoot a high-intensity subject (in this case, the headlights). As a result, images around the headlights, that is, the rest of the subject, except the headlights, becomes relatively dark, and poorly distinguished. However, using the slow AE function means the AE response speed will be slower, and response time will be longer. As a result, even if the camera catches a high-intensity subject (e.g., the headlights) for a moment, you can still easily distinguish the portions of the image surrounding the headlights.

Note

The Slow AE function does not work while the Spot AE mode is turned ON.

Aperture Control

Aperture control is a function which adjusts the edge enhancement of objects in the picture. There are 16 levels of adjustment, starting from “no enhancement.” When shooting text, this control may help by making them sharper.

Backlight Compensation

When the background of the subject is too bright, or when the subject is too dark due to shooting in the AE mode, back light compensation will make the subject appear clearer. This function operates during AE Full Auto Mode.

Note

Wide-D/HLC/Backlight Compensation/AE Mode (Manual / Iris Priority / Shutter Priority) / Spot AE do not work at the same time.

Wide Dynamic Range Mode (Wide-D)

The Wide Dynamic Range mode is a function for dividing an image into several blocks and correcting blocked-up shadows and blown-out highlights in accordance with the intensity difference. It enables you to obtain images in which portions ranging from dark to light can be recognized, even when capturing a

subject with a large intensity difference that is backlit or includes extremely light portions.

Images with wide dynamic range are produced by combining long-exposure signals (normal shutter) with the signals of the high-intensity portions obtained with a short exposure (high-speed shutter).

• About Wide-D Set Parameter

(Command: 8x 01 04 2D 00 0q 0r 0s 00 00 00 00 FF)

q: Display brightness

(0: Dark to 6: Bright)

The brightness and the darkness can be adjusted to seven levels. The normal brightness is set to 3.

Initial setting: 3

r: Brightness compensation selection

(0: Darker, 1: Dark, 2: Standard, 3: Bright)

Set the area which you want to adjust the brightness of the image with Wide-D effect.

Initial setting: 2

s: Compensation level

(0: Low, 1: Mid, 2: High)

The compensation of the brightness, which you select from the parameter, can be set to three levels.

Initial setting: 1

Notes

- When the Wide-D is On, false colors may appear in some parts of the image. This phenomenon is unique to Wide-D, and is not an indication of a camera malfunction.
- When Wide-D is switched, images may be distorted.
- Wide-D/HLC/Backlight Compensation/Spot AE do not work at the same time.
- After the Wide-D ON/OFF switchover, the Visca command will not be accepted for up to 2 seconds and an error message may be returned from the camera.
- The three types of functions : Wide-D, OSD (Title, PZM, Display), 3DNR do not work at the same time. For example, when OSD and 3DNR are on and Wide-D is turned on, 3DNR is automatically turned off. At this time, the NR mode will automatically switch to 2D/3D independent setting mode. For details, see “State transitions of the exclusive control function” on page 30.

Visibility Enhancer (VE)

Depending on the imaging scene, the Visibility Enhancer function makes the darker part of a camera image brighter, and automatically correct brightness and contrast to show bright parts clearly.

Note

This function is also used in the Wide-D operation.

Defog

When the surrounding area of the subject is foggy and low contrast, the defog mode will make the subject appear clearer.

For this function, you can select from OFF, Low, Middle and High.

HLC

HLC (highlight correction) is a function to adjust AE and AF, and to perform the masking of light area as required when a high intensity spot light is detected. It allows you to easily read the number of vehicles and number plate in the indoor parking area or in the outdoor during the night.

Note

Wide-D/HLC/Backlight Compensation/Spot AE do not work at the same time.

MinimumShutter

When the subject becomes dark, the shutter speed becomes slow, and then the gain is increased. This is a function to put a limit on the shutter speed. It prevents the camera shake when you shoot a moving subject in a dark place.

Noise Reduction (NR)

The NR function removes noise (both random and non-random) to provide clearer images. The functions of both 2D NR (removal of 2-dimensional noise) and 3D NR (removal of 3-dimensional noise) are provided. When the 2D NR level is increased, the details of image may be lost because the smoothing of image with the peripheral area is performed. Also, when the 3D NR level is increased, adverse effects such as image blur and blending in the successive images occur in the moving portion. In this function, the mode to set the level of effect by combining 2D/3D (normal setting) and the mode to individually set the level of effect respectively (independent setting) are available.

- In the normal setting, you can select the noise reduction level from 6 levels: levels 1 to 5, plus off. In this setting, the users cannot adjust the ratio of 2D/3D effect level.
- In the independent setting, you can individually select the 2D NR and 3D NR from 6 levels respectively: levels 1 to 5, plus off.

The NR effect is applied in levels based on the gain, and this setting value determines the limit of the effect. In bright conditions, changing the NR level will not have an effect.

High sensitivity mode

This function increases the max gain to allow bright output in darker environments. However, with a strong gain (up to 10×), the captured image will contain a lot of noise.

Flicker Reduction

This function automatically reduces flicker such as that caused by fluorescent light.

When the camera detects flicker, it automatically changes the shutter speed and reduces flicker.

The shutter speed is automatically selected according to conditions such as subject brightness and the Auto Slow Shutter setting.

See the table below for the shutter speed to be selected.

Monitoring mode	Flicker Frequency	Shutter speed
60 FPS	50 Hz	Auto Slow Shutter OFF: 1/100 Auto Slow Shutter ON: 1/100, 1/50, 1/25, 1/12.5
30 FPS	50 Hz	Auto Slow Shutter OFF: 1/100, 1/50 Auto Slow Shutter ON: 1/100, 1/50, 1/25, 1/12.5
50 FPS	60 Hz	Auto Slow Shutter OFF: 1/120, 1/60 Auto Slow Shutter ON: 1/120, 1/60, 1/30, 1/15
25 FPS	60 Hz	Auto Slow Shutter OFF: 1/120, 1/60, 1/30 Auto Slow Shutter ON: 1/120, 1/60, 1/30, 1/15

If the camera does not detect flicker, it will run normal AE operation.

Notes

- This function operates only during AE-Full Auto.
- Flicker Reduction does not work in AE-Shutter Priority/Iris Priority/Manual/Spot AE or Wide-D.
- After the camera detects flicker and the shutter speed is changed, Extended Normal Shutter and Minimum Shutter are inoperative.
- The Flicker Reduction may not work if the subject is bright under an environment where flicker occurs. If the shutter speed is 1/100 (flicker frequency 50 Hz) or 1/120 (flicker frequency 60Hz) and the brightness exceeds the Iris variable area (F14), stop the Flicker Reduction and run a normal AE operation.

Flicker Detection

The Flicker Detection command allows you to perform flicker detection.

Notes

- Flicker detection cannot be performed for a few seconds (approximately 6 seconds at 60/50fps, approximately 7 seconds at 30fps, approximately 8 seconds at 25fps) after turning the power-on.

- If a frequency including a folding frequency is detected, correct detection may not be possible.

Variable Gamma Mode

There are standard (00h) mode and straight gamma (01h) mode.

Gamma Offset

You can set the black level offset from -64 to $+64$ in each variable gamma mode.

Contrast Adjustment Function

You can adjust the contrast level in the range from 0 (00h) to 255 (FFh). The initial setting is 128 (80h). The smaller the value is, the lower the contrast becomes, and the larger the value is, the higher the contrast becomes.

Note

This function is available when the variable gamma mode is set to standard (00h) mode and when VE/Wide-D/HLC are set to OFF.

Temperature Reading Function

The conversion value (hex) of the temperature sensor built into the camera can be read by using a query command. The conversion value has an error of ± 3 °C, and because the temperature sensor is inside the camera, this value is not the ambient temperature. Use it as a reference value.

Image Stabilizer

Switching On the Image Stabilizer function reduces image blurring caused by, for example, vibration, which allows you to obtain images without much blurring. There are two types of levels, Super and Super+. Set the level to Super to reduce vibration. Set the level to Super+ to further reduce vibration. The Image Stabilizer function employs the digital zoom system, so the angle of view and resolution are changed, but the sensitivity is maintained.

Note

When using the Image Stabilizer function in situations where the camera itself is moving, such as panning or tilting, it is recommended to set the Image Stabilizer setting to HOLD when panning or tilting. By changing the setting from ON to HOLD before panning or tilting, and then changing the setting from HOLD to ON after panning or tilting, it is possible to suppress the recoil of blur correction when the camera stops moving.

“StableZoom”

“StableZoom” is a function for performing correction using the Image Stabilizer function in accordance with the zoom ratio, and smoothly zooming up to approximately 36 \times using a combination of the enhanced optical zoom and digital zoom. As no digital zoom by the Image Stabilizer is available on the wide side, you can obtain a wider image with no resolution degradation. Only the electronic zoom operates between Wide end and 1.2 \times , and only the enhanced optical zoom operates between 1.2 \times and Tele end. The Image Stabilizer does not work only at the Wide end. The “StableZoom” function can be switched On/Off in the register settings.

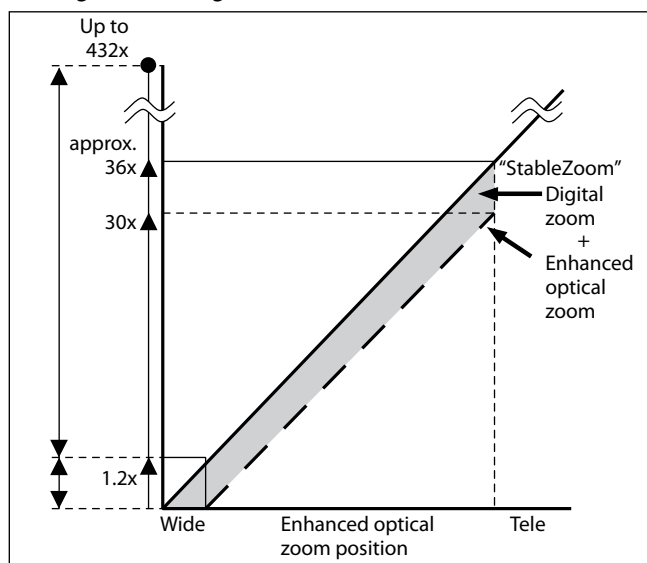

Hold Function of Image Stabilizer

With the Image Stabilizer function, suddenly stopping high-speed movement (pan, tilt, etc.) of the camera produces a blur sensor counteraction that may cause image movement. In such a case, you can use a command setting (hold) to maintain the correction of the Image Stabilizer function. In this case the image stabilizer is off, but there is no change in the angle of view.

Notes

- The image stabilizer function may not work correctly under the condition that high-frequency vibration component exists. In such a case, set the image stabilizer function to Off.
- The StableZoom and Zoom Separate mode do not work at the same time. When one function is ON, the other function cannot be turned ON.

Auto Slow Shutter On/Off

When set to “On,” the slow shutter functions automatically when the light darkens. This setting is available only when the AE mode is set to “Full Auto.” The initial setting is “Auto Slow Shutter Off.”

Low-Illumination Chroma Suppress Mode

You can configure a chroma suppress mode for low-illumination conditions. This can be useful when color noise is particularly noticeable in such conditions. Four levels (disabled and three levels) are available for the low-illumination chroma suppress mode.

ICR (IR Cut-Removable) Mode

An infrared (IR) Cut-Filter can be disengaged from the image path for increased sensitivity in low light environments. The ICR will automatically engage depending on the ambient light, allowing the camera to be effective in day/night environments.

When the auto ICR mode is set to On, the image becomes black and white.

Custom Color Gain

You can configure the color gain.

The initial setting is 4h and the setting can be set to 15 levels from 0h to Eh.

The higher the setting value, the higher the color saturation. The lower the setting value, the lower the color saturation.

Custom Color Phase

You can configure the color phase.

The initial setting is 7h and the setting can be set to 15 levels from 0h to Eh.

The higher the setting value, the color phase shifts to the + side. The lower the setting value, the color phase shifts to the – side.

Auto ICR Mode

Auto ICR Mode automatically switches the settings needed for attaching or removing the IR Cut Filter. With a set level of darkness, the IR Cut Filter is automatically disabled (ICR On), and the infrared sensitivity is increased. With a set level of brightness, the IR Cut Filter is automatically enabled (ICR Off). Also, on systems equipped with an IR light, the internal data of the camera is used to make the proper decisions to avoid malfunctions.

Auto ICR Mode operates with the AE Full Auto setting. When the Auto ICR On (Color) is set, the color is added.

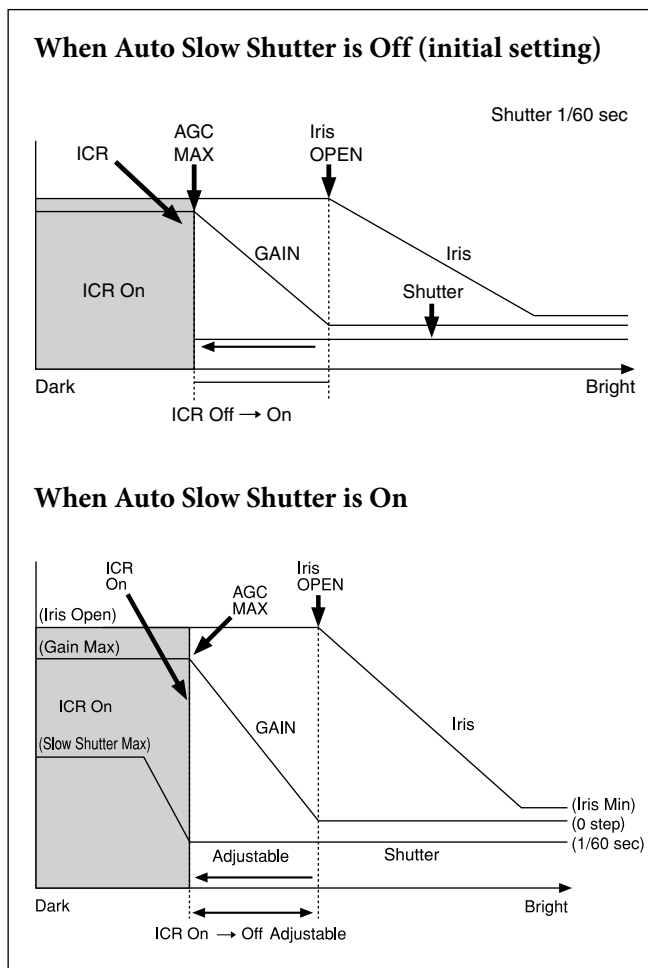

Note

- Depending on the information such as brightness, etc., in the On/Off settings condition, a malfunction may occur when the subjects largely consisting of blue and green colors are taken.
- In Auto ICR On (Color), false colors may appear on the subject when under certain light sources including infrared.

Camera ID

The ID can be set up to 65,536 (0000h to FFFFh). As this will be memorized in the nonvolatile memory inside, data will be saved.

Picture Effect

It consists of the following functions.

- **Black & White:** Monochrome Image

Others

E-FLIP

This function reverses the video output from the camera vertically and horizontally.

LR Reverse

This function reverses the video output from the camera horizontally.

Freeze

This function captures an image in the field memory of the camera so that this image can be output continuously.

Note

Because communication inside the camera is based on V cycle, the captured image is always the one 3V to 4Vs after the sending of a Command. Thus, you can not specify a time period after sending EVEN, ODD or a Command.

Memory (Position preset)

Using the position preset function, 16 sets of camera shooting conditions can be stored and recalled.

This function allows you to achieve the desired status instantly, even without adjusting the following items each time.

- Zoom Position
- Digital Zoom On/Off
- Focus Auto/Manual
- Focus Position
- AE Mode
- Shutter control parameters
- Iris control parameters
- Gain control parameters
- Exposure Compensation On/Off
- Exposure Level
- Backlight Compensation On/Off
- Auto Slow Shutter On/Off
- White Balance
- R/B Gain
- Aperture Control
- ICR On/Off
- Defog
- Wide-D On/Off
- Wide-D Parameter
- VE On /Off
- VE Parameter
- Minimum Shutter Mode
- Minimum Shutter Limit
- Spot AE On/Off
- Spot AE Display On/Off
- Spot AE Parameter
- Spot AWB On/Off
- Spot AWB Display On/Off
- Spot AWB Parameter
- Spot Focus On/Off
- Spot Focus Display On/Off

• Spot Focus Parameter

Custom Preset

As with the position preset function, the camera shooting conditions can be stored and recalled. The settings are recalled when the power is turned on. *For setting items, see the “Initial settings and backup of camera” section on page 26.*

User Memory Area

This is the memory area with 16-byte capacity which users can overwrite freely. This can be used as a Serial No. for individual recognition.

Note

Rewriting of memory is not unlimited. Be careful to avoid using the memory area for such as unnecessary tasks as rewriting the contents of the memory for every operation.

Register Setting

The camera's initial settings can be changed by the register setting command.

Register Setting Command:

8x 01 04 24 mm 0p 0q FF
 mm: Register No. (=00 to 7F)
 pq: Register Value (=00 to FF)

Register Inquiry Command:

8x 09 04 24 mm FF
 mm: Register No.
 y0 50 0p 0p FF
 pp: Register Value
 (returned from the camera.)

The register setting items and No. are as follows. *For details, see “Register Setting” on page 56.*

Baud Rate: 00

Communication speed can be changed.

Monitoring Mode: 72

The output mode can be set.

LVDS Mode: 74

The LVDS output mode can be set.

Zoom Limit: 50 (Wide end), 51 (Tele end)

The Wide and Tele zoom limits can be set.

D-Zoom Max: 52

The maximum digital zoom limit can be set (initial setting is 12×).

“StableZoom”: 53

ON/OFF can be set. (initial setting is OFF.)

For details, see “StableZoom” on page 14.

FocusTrace: 54

When you want to prioritize zoom speed, set FocusTrace to Off to minimize the transition time between Wide and Tele zoom (although the image may be blurred because focus is not tracked).

FocusOffset: 55

Placing a dome cover in front of the camera may cause the focal distance of the camera to change. Especially at the Tele end, this effect exceeds the AF range, so focus cannot track. In this case, the AF range can be expanded by changing this value, but the closer to the Tele end, the longer the minimum focus distance.

Set value	00	40	80	C0	FF
Minimum focus distance	1.2 m	1.5 m	1.7 m	2 m	3 m

For details, see “Register Setting” on page 56.

AE parameter change during VE On, Defog On: 58

ON/OFF can be set. (initial setting is ON.)

Auto slow shutter limit: 59

The auto slow shutter limit can be set. (initial setting is 04.)

For details, refer to “Register Setting” (page 56).

Extended normal shutter: 5A

The lower limit of slow shutter when the Auto Slow Shutter mode is set to OFF can be set. (initial setting is OFF.)

Defog Limit: 5B, 5C, 5D

The maximum value of Defog mode in the low, mid and high levels can be set respectively.

Extended mode: 5F

ON/OFF can be set. (initial setting is OFF.)

For details, see “Extended Mode” on page 56.

Spot Light Avoidance: 20

ON/OFF can be set. (initial setting is OFF.)

Note

For the reflection timing when the register setting is changed, see the setting value reflection timings in “Register Setting” (page 56).

Privacy Zone Masking Settings

For details, see “Privacy Zone Masking Function” on page 18.

Motion detection

For details, see “Motion Detection (MD) Function” on page 20.

Title Display

- You can set a title of up to 11 lines. One line can contain up to 20 characters.
- You can set display on/off, the horizontal position of the first character, blinking state and color for each line.
- The camera gives priority to a title display when the camera status is displayed on the relevant line. On the lines where a title is not set, the camera status is displayed.

Line Number	00h to 0Ah	
H-position	00h to 1Fh	
Color	00h	WHITE
	01h	YELLOW
	02h	VIOLET
	03h	RED
	04h	CYAN
	05h	GREEN
	06h	BLUE
Blink	00h	Off
	01h	On

00	01	02	03	04	05	06	07
A	B	C	D	E	F	G	H
08	09	0A	0B	0C	0D	0E	0F
I	J	K	L	M	N	O	P
10	11	12	13	14	15	16	17
Q	R	S	T	U	V	W	X
18	19	1A	1B	1C	1D	1E	1F
Y	Z	&		?	!	1	2
20	21	22	23	24	25	26	27
3	4	5	6	7	8	9	0
28	29	2A	2B	2C	2D	2E	2F
À	È	Ì	Ò	Û	Á	É	Í
30	31	32	33	34	35	36	37
Ó	Û	Â	Ê	Ô	Æ		Ã
38	39	3A	3B	3C	3D	3E	3F
Ö	Ñ	Ç	ß	Ä	Ï	Ö	Ü
40	41	42	43	44	45	46	47
Å	\$		¥		£	¿	¡
48	49	4A	4B	4C	4D	4E	4F
ø	”	:	’	.	,	/	-

Privacy Zone Masking Function

Privacy Zone masking protects private objects and areas such as house windows, entrances, and exits which are within the camera's range of vision but not subject to surveillance.

Privacy zone masking can be masked on the monitor to protect privacy.

Features

- Mask can be set on up to 24 places according to Pan/Tilt positions.
- Mask can be displayed on 8 places per screen simultaneously.
- Individual on/off zone masking settings.
- Two colors can be individually set for each of 24 privacy zones.
- Interlocking control with zooming.
- Interlocking control with Pan/Tilt.
- Non-interlocking control with Pan/Tilt.

Details of Setting Commands

Set Mask

Command: 8x 01 04 76 mm nn 0r 0r 0s 0s FF

Parameters:

mm	Setting Mask See "mm: Mask setting list" in "Parameters" on page 19.
nn	Selects new setting or resetting for the zone. See "nn:Setting" in "Parameters" on page 19.
rr	Sets the half value "w" of the Mask Width.
ss	Sets the half value "h" of the Mask Height. See "pp: x, qq: y, rr: w, ss: h" in "Parameters" on page 19.

Comments: To set the mask, first display the object at the center of the screen. When "nn" is set to 1, the current Pan/Tilt/Zoom Position is recorded in internal memory.

When "nn" is set to 0, the Pan/Tilt/Zoom Position in memory is not changed.

Notes

- The tilt angle at which you can set the mask is between -70 to +70 degrees.
- It is recommended that you set the size to at least twice the size of the object (height and width).

Set Display

Command: 8x 01 04 77 pp pp pp pp FF

Parameter:

pp pp pp pp	Each 24 Privacy Zones corresponds to the BIT. See "pp pp pp pp: Mask bit" in "Parameters" on page 19.
-------------	--

Comments: Each of 24 Privacy zones can be switched on and off individually by a single VISCA Command. If you want to display a Privacy zone, you must set its bit to 1. If you do not want to display a Privacy zone, you must set its bit to 0.

Set Mask Color

Command: 8x 01 04 78 pp pp pp pp qq rr FF

Parameter:

pp pp pp pp	Each 24 Privacy Zones correspond to the BIT. See "pp pp pp pp: Mask bit" in "Parameters" on page 19.
qq	Set the color code
rr	Set the color code. See "qq, rr: Color code" in "Parameters" on page 20.

Comments: Two different color masks can be chosen. Two colors can be individually set for each of 24 privacy zones.

If the bit of parameter (pp pp pp pp) is set to "0", mask color will be "qq" color (Color code). If the bit of parameter (pp pp pp pp) is set to "1", the mask color will be "rr" color (Color code).

Example: 8x 01 04 78 00 00 00 03 00 07 FF

The mask color of Mask_A and Mask_B is White (color code 07h), and the mask color of the other Mask (C to X) is Black (color code 00h).

Set Pan Tilt Angle

Command: 8x 01 04 79 0p 0p 0p 0q 0q 0q FF

Parameter:

ppp	Pan Angle
qqq	Tilt Angle See "Setting pan/tilt angle" in "Parameters" on page 20.

Comments: Pan/Tilt angle settings are hexadecimal data.

The resolution of Pan/Tilt angle is 0.088 degrees.

Notes

When you set the pan/tilt angle, locate the pan/tilt position at the center point of the FCB camera's position.

Set PTZ Mask

Command: 8x 01 04 7B mm 0p 0p 0p 0q 0q 0q 0r 0r 0r 0r FF

Parameter:

mm	Setting Mask See “mm: Mask setting list” in “Parameters” on page 19.
ppp	Pan Angle (000 to FFF) See “Setting pan/tilt angle” in “Parameters” on page 20.
qqq	Tilt Angle (000 to FFF) See “Setting pan/tilt angle” in “Parameters” on page 20.
rrrr	Zoom Position (000 to 4000) See “Zoom Ratio and Zoom Position (for reference)” on page 54.

Comments: Mask can be set at the desired position by setting the pan tilt angle and zoom position using this command.
The set value can be input by hexadecimal number.

Note

Privacy mask zone follows the change of angle of view according to zoom. However, the follow might be delayed for a moment if there is any big change, such as when using D-Zoom or E-FLIP.

Non Interlock Mask

Command: 8x 01 04 6F mm 0p 0p 0q 0q 0r 0r 0s 0s FF

Parameters:

mm	Setting Mask See “mm: Mask setting list” in “Parameters” on page 19.
pp	Sets the center position “x” of the Mask on screen.
qq	Sets the center position “y” of the Mask on screen.
rr	Sets the half value “w” of the Mask Width.
ss	Sets the half value “h” of the Mask Height. See “pp: x, qq: y, rr: w, ss: h” in “Parameters” on page 19.

Commands: Mask does not interlock with pan/tilt.
The limitations of parameters are as follows.
(hexadecimal representation)

x: ±50h w: ±50h
y: ±2Dh h: ±2Dh

Note

When the Set Mask command and the Non Interlock Mask command are set to the same mask, the command set later becomes effective.

Parameters

mm: Mask setting list

Mask Name	mm (Hex)	Mask Name	mm (Hex)
Mask_A	00h	Mask_M	0Ch
Mask_B	01h	Mask_N	0Dh
Mask_C	02h	Mask_O	0Eh
Mask_D	03h	Mask_P	0Fh
Mask_E	04h	Mask_Q	10h
Mask_F	05h	Mask_R	11h
Mask_G	06h	Mask_S	12h
Mask_H	07h	Mask_T	13h
Mask_I	08h	Mask_U	14h
Mask_J	09h	Mask_V	15h
Mask_K	0Ah	Mask_W	16h
Mask_L	0Bh	Mask_X	17h

nn: Setting

nn	Setting
00h	Resetting the zone size (the value of w, h) for the existing mask.
01h	Setting newly the zone size (the value of w, h).

pp: x, qq: y, rr: w, ss: h

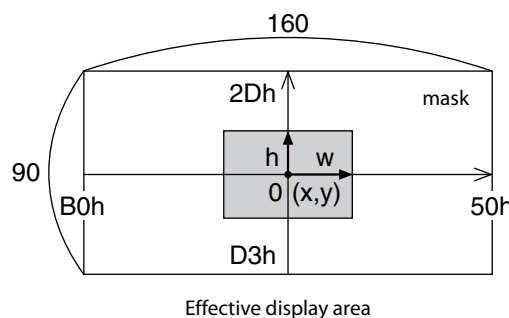

Note

The priority order of the mask display is in the sequence from A (highest) to X (lowest). When you set the parameters of masks non-sequentially, it is recommended that you set the mask whose priority order is higher, first.

pp pp pp pp: Mask bit

	pp								pp							
bit	7	6	5	4	3	2	1	0	7	6	5	4	3	2	1	0
Mask	-	-	X	W	V	U	T	S	-	-	R	Q	P	O	N	M

	pp								pp							
bit	7	6	5	4	3	2	1	0	7	6	5	4	3	2	1	0
Mask	-	-	L	K	J	I	H	G	-	-	F	E	D	C	B	A

The “-” must be “0”.

qq, rr: Color code

Mask (color)	Code (qq, rr)
Black	00 h
Gray1	01 h
Gray2	02 h
Gray3	03 h
Gray4	04 h
Gray5	05 h
Gray6	06 h
White	07 h
Red	08 h
Green	09 h
Blue	0A h
Cyan	0B h
Yellow	0C h
Magenta	0D h

Setting pan/tilt angle

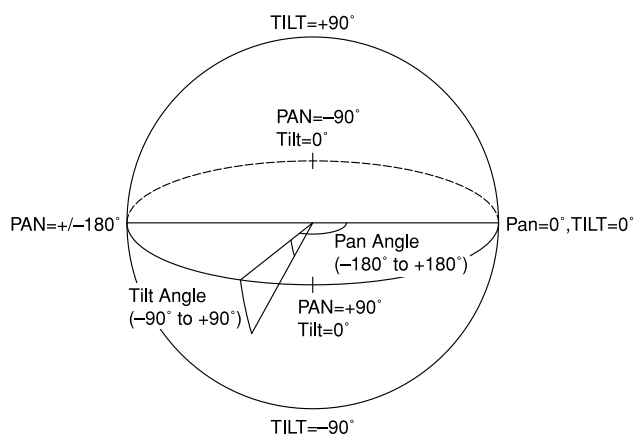
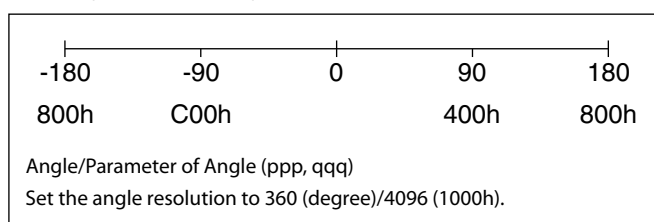

Motion Detection (MD) Function

This function instructs the camera to detect movement within the monitoring area and then send an alarm signal automatically.

The Detect signal goes out through the VISCA Command.

Features

- You can set a frame for the detection range of 16 (horizontally) × 12 (vertically) blocks.
- You can set up to four frames.
- When the motion is detected in the set frame, the Alarm Replay VISCA Command is sent.
- The threshold level for detection can be set (common to four frames).
- The interval of alarm detection can be set up to 255 seconds in units of one second.
- You can select ON/OFF for each frame.
- The frame number is also sent with Alarm Replay to report in which frame the motion has been detected.

Frames

Setting frames

You can set the frame by assigning the starting point and terminating point vertically and horizontally. You can set up to four frames.

When motion is detected within the range where frames overlap

The alarms are sent for both frames.

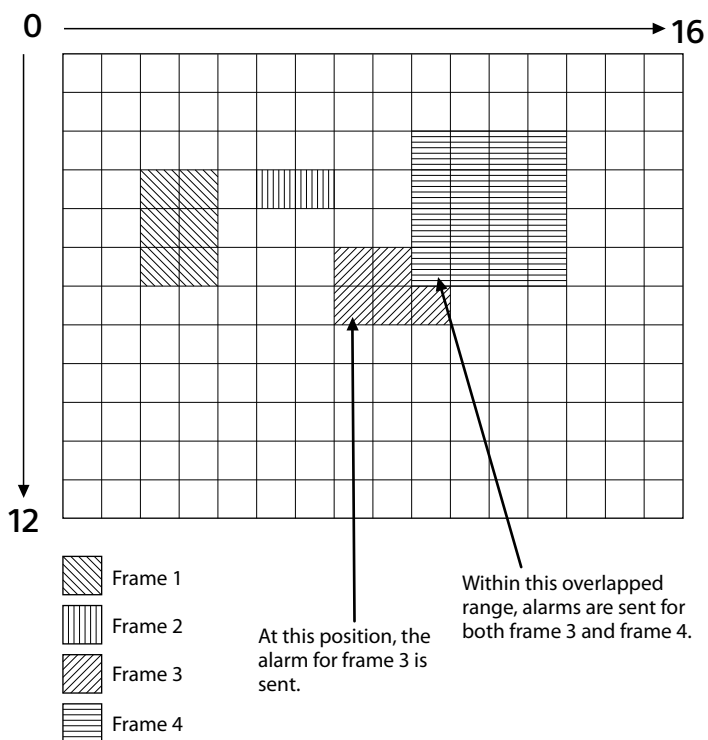

Sending Alarms

- When motion is detected, the Alarm Replay command is issued via the serial command (VISCA) communication line.
- When multiple motions are detected or motion is detected in another frame within the set interval following the original time the alarm was issued, another alarm command is not issued.
- When motion is detected after the interval time elapsed, the alarm is issued again.

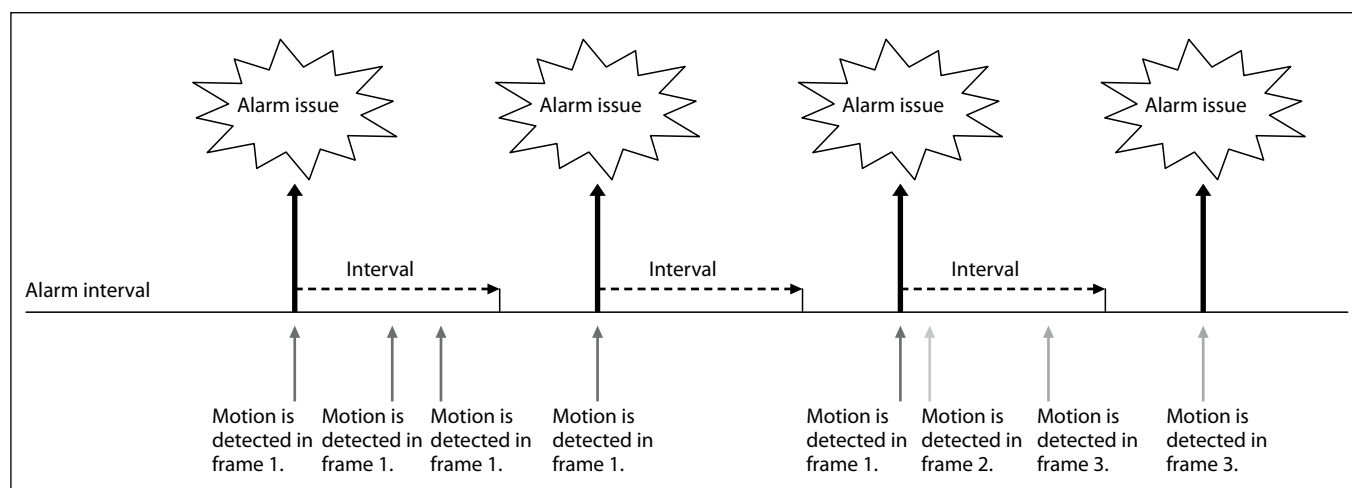

Setting Commands

• MD On/Off

The Display mode is selected by the Function Set command and frames are set by the Frame Set command. By sending an MD On command, the frame is displayed when motion is detected in the set frame. The Alarm Reply command is sent via the serial command (VISCA) communication line.

8x 01 04 1B 02 FF --- On

8x 01 04 1B 03 FF --- Off

• Function Set

Select the detected frame, and set the Threshold Level and the Interval Time.

8x 01 04 1C 0m 0n 0p 0q 0r 0s FF

m: Display Mode on/off (bit0)

n: Detection Frame set on/off (bit0:Frame0, bit1: Frame1, bit2:Frame2, bit3:Frame3)

- (0 to F)

pq: Threshold - (00 to FF)

rs: Interval time set - (00 to FF)

(When pq and rs are 0, the command is received, but the setting is disabled.)

• Window Set

You can set up to four frames by assigning the starting and terminating points.

Notes

- Set a terminating point higher vertically and horizontally than the starting point. If you set the wrong value, an error occurs.
- It is recommended to set the frame setting a little larger to account for lens distortion.

8x 01 04 1D 0m 0p 0q rr 0s FF

m: Select Detection Frame (0: Frame0, 1: Frame1, 2: Frame2, 3: Frame3) - (0, 1, 2, 3)

p: Start Horizontal Position - (0 to F)

q: Start Vertical Position - (0 to B)

rr: Stop Horizontal Position - (01 to 10)

s: Stop Vertical Position - (1 to C)

• Alarm Reply

When motion is detected in the set frame, the camera issues this command. This command includes the information on the number of the detected frame.

y0 07 04 1B 0p FF

p: Frame Number (bit0: Frame0, bit1: Frame1, bit2: Frame2, bit3: Frame3)

Extended Commands

Extended commands support the following functions (described previously).

Turn on this mode (for details, see “Extended Mode” in “Register Setting” on page 56) to enable the following functions.

- **Exposure Compensation**

The setting can be set in steps of approximately 0.2dB (–128 (00h) to approximately +127 (FFh)).

For details, see page 11.

- **Aperture Control**

The setting can be set to 256 levels (00h to FFh).

For details, see page 12.

- **Custom Color Gain**

You can configure the color gain.

The initial setting is 80h and the setting can be set to 256 levels from 00h to FFh.

The higher the setting value, the higher the color saturation. The lower the setting value, the lower the color saturation.

You can set the color saturation more widely and finely than the normal color gain variable.

For details, see page 15.

- **Custom Color Phase**

You can configure the color phase.

The initial setting is 80h and the setting can be set to 256 levels from 00h to FFh.

The higher the setting value, the color phase shifts to the + side. The lower the setting value, the color phase shifts to the – side.

You can set the color phase more finely than the normal color phase variable.

For details, see page 15.

- **Auto ICR Mode**

The setting of ICR ON→OFF threshold can be set when Auto ICR is on.

The setting range is 0 step (00h) to 255 step (FFh).

The setting of ICR OFF→ON threshold (On Level) can be set when Auto ICR is on.

The setting range is 0 step (00h) to 28 step (1Ch).

For details, see page 15.

Note

When the extended mode is Off, CMD_NOT_EXEC will be returned if you send the extended commands to the camera.

When the extended mode is On, CMD_NOT_EXEC will be returned if you send the normal commands to the camera.

Firmware Update

Overview

This section describes the firmware update procedure. To perform the firmware version upgrade, the following three steps are required.

- 1) Shifting to the maintenance mode using the Visca command
- 2) Binary transmission (X modem protocol) of the firmware in the maintenance mode
- 3) Finalizing setting using the Visca command

Each step is described as follows.

- 1) **Shifting to the maintenance mode using the Visca command**

After entering the standby mode using the Visca command, the unit shifts to the maintenance mode. Note that if the power is turned off during the writing, the program will be broken and cannot be restored.

- 2) **Binary transmission (X modem protocol) of the firmware in the maintenance mode**

Serial Port Setting during maintenance mode

Communication Speed	115200 bps
Data bit	8 bit
Parity	None
Stop bit	1 bit
Flow control	None

In the maintenance mode, the terminal software capable of sending the character command is used.

The terminal software that is provided with the XMODEM binary transfer protocol is used.

When you transfer the camera firmware (uug.bin file) using this function, the transferred file is written in FlashROM. The writing takes approximately 10 minutes.

Note that if the power is turned OFF during writing, the program may be broken and may not be restorable.

After the writing is completed, the unit restarts automatically, and then the camera firmware is started.

- 3) **Finalizing setting using the Visca command**

The finalizing setting is performed using the Visca command.

You cannot read the correct camera firmware version without performing this setting. Be sure to perform this setting.

Update Procedure

Enter Maintenance Mode

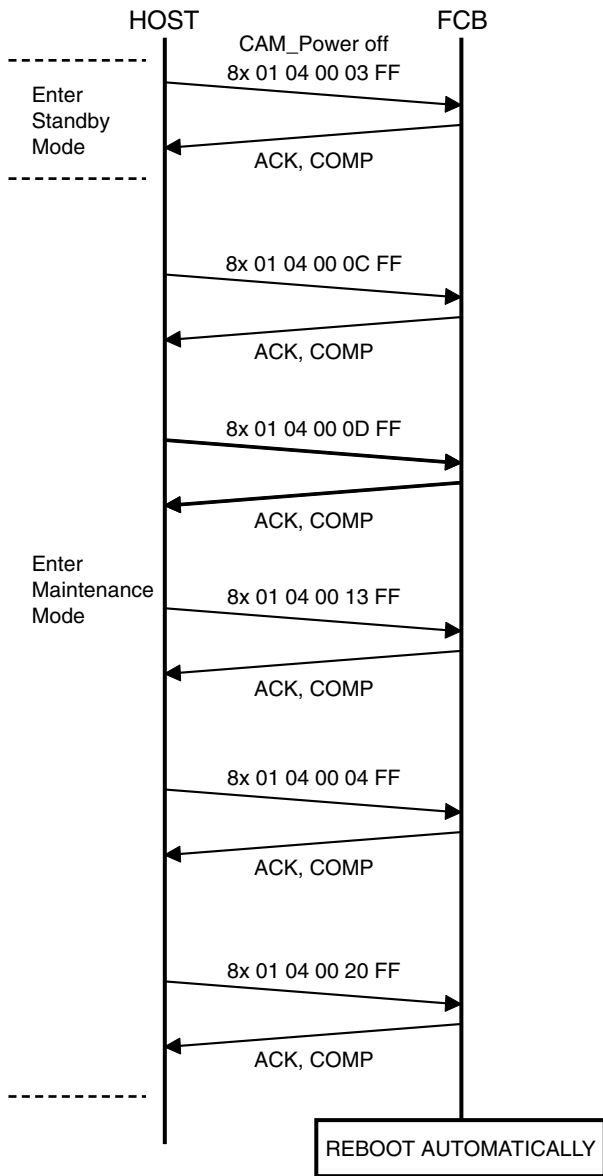

* Do not turn OFF the power while updating because there is a possibility that the camera will break.

Maintenance Mode

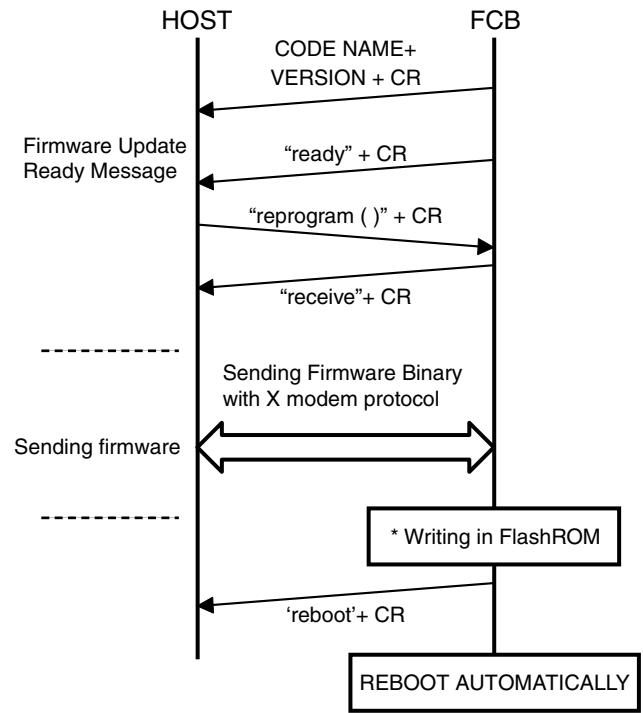

* Do not turn OFF the power while updating because there is a possibility that the camera will break.

Finalizing procedure

After the maintenance mode, perform the following finalizing procedure.

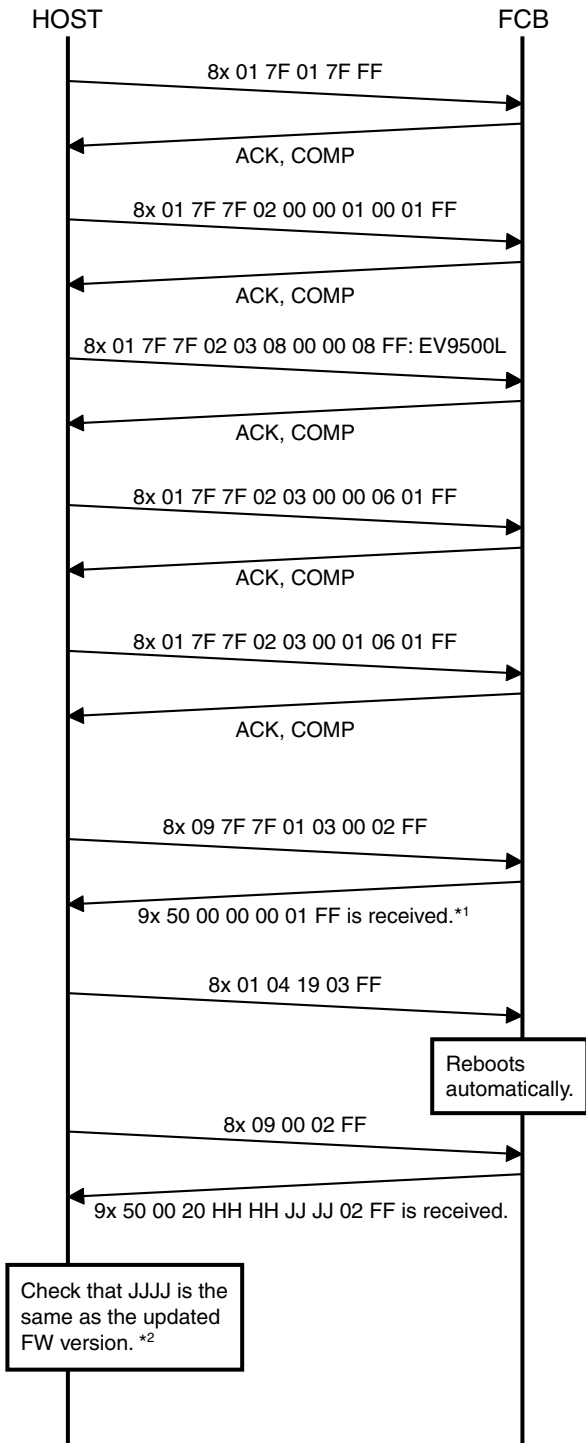

*1 When 9x 50 00 00 00 01 FF is received, retransmit 8x 09 7F 7F 01 03 00 02 FF until 9x 50 00 00 00 01 FF is received.

*2 If it is not the same, perform the update procedure from the beginning.

Eclipse

When designing the housing, refer to the dimensional allowance as shown in the figure below.

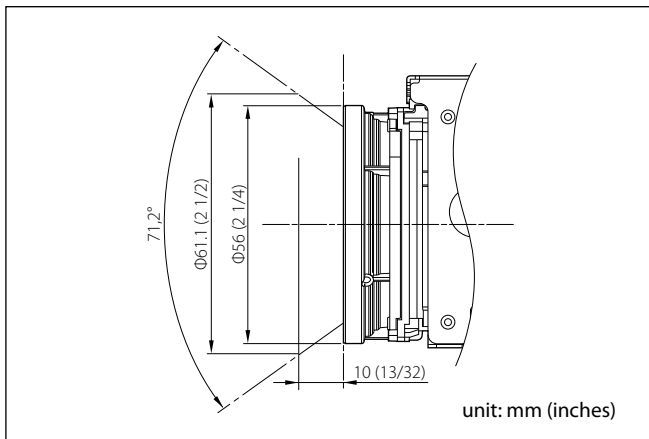

Spectral Sensitivity Characteristics

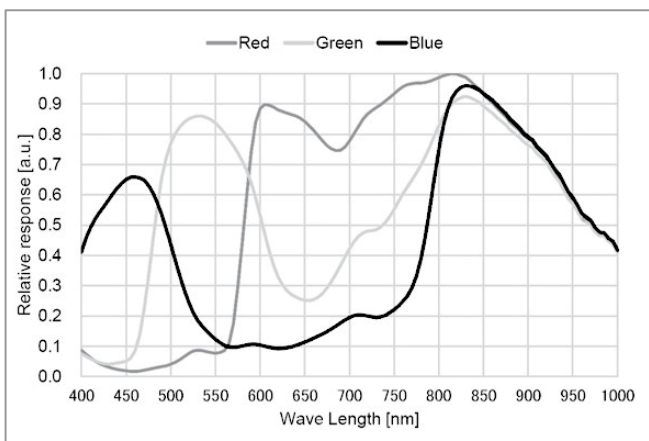

Use the graph as a reference value. (We can not guarantee these values.)

This data is measured when the IR cut filter is removed and the characteristics of the lens and optical source characteristics are ignored.

Initial settings and backup of camera

“Initial settings” is the factory preset value.

“Custom Preset”, indicates data that can be stored with ○ and data that cannot be stored with × using the custom preset function.

“Back up on standby” indicates that ○ is retained while on Standby and × is not retained.

Mode/Position setting	Initial Settings	Custom Preset	Back up at standby
Zoom Position	Wide end	○	○
D-Zoom On/Off	On	○	○
D-Zoom Separate/Combine	Combine	○	○
D-Zoom Position	00h	○	○
Focus Position	—	○	○
Focus Auto/Manual	Auto	○	○
Near Limit Setting	D000h	○	○
AF Sensitivity	Normal	○	○
AF Mode	Normal	○	○
AF Run Time	5 sec	○	○
AF Interval	5 sec	○	○
Spot Focus ON/OFF	Off	○	○
Spot Focus Set parameter	Starting point (3,2), terminating point (5,4)	○	○
Spot Focus DISPLAY	Off	○	○
WB Mode	Auto	○	○
WB Data (Rgain, Bgain)	—	○	○
Spot AWB ON/OFF	Off	○	○
Spot AWB Set parameter	Starting point (3,2), terminating point (5,4)	○	○
Spot AWB DISPLAY	Off	○	○
One Push WB Data	—	○	○
AE Mode	Full Auto	○	○
AE Response	01h	○	○
Auto Slow Shutter Mode	Off	○	○
Shutter Position	—	○	○
Iris Position	—	○	○
Gain Position	—	○	○
Exposure Compensation On/Off	Off	○	○
Exposure Compensation Amount	±0	○	○
BackLight On/Off	Off	○	○
Spot AE On/Off	Off	○	○
Spot AE Set parameter	Starting point (3,2), terminating point (5,4)	○	○
Spot AE DISPLAY	Off	○	○
Aperture Level	Ah	○	○
LR Reverse On/Off	Off	○	○
Freeze On/Off	Off	×	×
Picture Effect	Off	○	○
ICR On/Off	Off	○	○
Auto ICR On/Off/On(Color)	Off	○	○
Auto ICR Threshold Level	0Eh	○	○
Camera Memory	Same as the initial value setting	×	○
Display On/Off	Off	○	○
Mute On/Off	Off	×	×
Auto ICR Alarm On/Off	Off	○	○
Image Stabilizer On/Off/Hold	Off	○	○
Image Stabilizer Level	Super	○	○
High Sensitivity mode On/Off	Off	○	○
Gamma	0: standard	○	○
Defog On/Off	Off	○	○

Mode/Position setting	Initial Settings	Custom Preset	Back up at standby
NR level (normal setting)	3	<input type="radio"/>	<input type="radio"/>
NR level (independent setting)	Disabled	<input type="radio"/>	<input type="radio"/>
Gain Limit	—	<input type="radio"/>	<input type="radio"/>
Low-Illumination Chroma Suppress	2h (Mid)	<input type="radio"/>	<input type="radio"/>
Color Gain	04h (100%)	<input type="radio"/>	<input type="radio"/>
Color Hue	7h (0 degrees)	<input type="radio"/>	<input type="radio"/>
Title Display On/Off	Off	<input type="radio"/>	<input type="radio"/>
Title Setting	—	<input type="radio"/>	<input type="radio"/>
Mask Setting	—	<input type="radio"/>	<input type="radio"/>
Mask Display On/Off	Off	<input type="radio"/>	<input type="radio"/>
Mask Color Setting	—	<input type="radio"/>	<input type="radio"/>
Center Line Display On/Off	Off	<input type="radio"/>	<input type="radio"/>
E-Flip On/Off	Off	<input type="radio"/>	<input type="radio"/>
Privacy Zone On/Off	Off	<input type="radio"/>	<input type="radio"/>
Privacy Zone Setting	—	<input type="radio"/>	<input type="radio"/>
Camera ID	0000h	<input type="checkbox"/>	<input type="radio"/>
MD On/Off	Off	<input type="radio"/>	<input type="radio"/>
MD Display Setting	Off	<input type="radio"/>	<input type="radio"/>
MD Threshold Level	10h	<input type="radio"/>	<input type="radio"/>
MD Interval	1 sec	<input type="radio"/>	<input type="radio"/>
MD Window Setting	—	<input type="radio"/>	<input type="radio"/>
ZoomPos Continuous Output On/Off	Off	<input type="checkbox"/>	<input type="radio"/>
ZoomPos Continuous Output Interval	3Ch	<input type="checkbox"/>	<input type="radio"/>
Minimum Shutter Mode	Off	<input type="radio"/>	<input type="radio"/>
Minimum Shutter Limit	1/125	<input type="radio"/>	<input type="radio"/>
HLC Level	Off	<input type="radio"/>	<input type="radio"/>
HLC Mask Level	Off	<input type="radio"/>	<input type="radio"/>
VE On/Off	Off	<input type="radio"/>	<input type="radio"/>
VE Parameter	Display brightness level: 3 Brightness compensation selection: 2 (Standard) Compensation level: 1 (Mid)	<input type="radio"/>	<input type="radio"/>
Wide-D On/Off	Off	<input type="radio"/>	<input type="radio"/>
Wide-D Parameter	Display brightness level: 3 Brightness compensation selection: 2 (Standard) Compensation level: 1 (Mid)	<input type="radio"/>	<input type="radio"/>
Contrast Adjustment	80h	<input type="radio"/>	<input type="radio"/>
Flicker Reduction	Off	<input type="radio"/>	<input type="radio"/>

Notes

- Acceptable number to write custom presets is limited.
- Privacy Zone Setting while digital zooming is not preserved by Custom Preset.

Mode Condition

Condition

Mode	Power Off	Initializing	Power On	Freeze On	MemRecall
Address Set	○	○	○	○	○
IF_Clear	○	○	○	○	○
Command Cancel	○	○	○	○	○
Power On/Off	○	○	○	○	○

Lens

Mode	Power Off	Initializing	Power On	Freeze On	MemRecall	Zoom Direct	Focus Direct	ZnFo Direct	Focus Auto
Zoom Tele/Wide/Stop	×	×	○	○	×	×	○	×	○
Zoom Direct	×	×	○	○	×	○	○	×	○
Zoom Focus Direct	×	×	○	○	×	×	×	○	×
D-Zoom On/Off	×	×	○	○	×	×	○	×	○
D-Zoom Separate/Combine	×	×	○	○	×	×	○	×	○
D-Zoom Tele/Wide/Stop	×	×	○	○	×	○	○	○	○
D-Zoom Direct	×	×	○	○	×	○	○	○	○
Focus Far/Near/Stop	×	×	○	○	×	○	○	×	×
Focus Direct	×	×	○	○	×	○	○	×	×
Focus Auto/Manual	×	×	○	○	×	○	×	×	○
One Push AF	×	×	○	○	×	○	×	×	×
Spot Focus ON/OFF	×	×	○	○	×	○	○	○	○
Spot Focus Setting	×	×	○	○	×	○	○	○	○
Focus Near Limit	×	×	○	○	×	○	×	×	○
AF Sensitivity Normal/Low	×	×	○	○	×	○	○	○	○
AF Mode Norm/Interval/Zoom	×	×	○	○	×	○	○	○	○
AF Activation Time/Interval Setting	×	×	○	○	×	○	○	○	○
Camera Memory Set/Reset	×	×	○	○	×	×	×	×	○
Camera Memory Recall	×	×	○	○	○	×	×	×	○
Lens Initialize	×	×	○	○	×	×	×	×	○

White Balance

Mode	Power Off	Initializing	Power On	Freeze On	MemRecall	WB Auto	Indoor	Outdoor	Outdoor Auto	Sodium Lamp	Sodium Lamp Auto	Sodium Lamp Outdoor Auto	One Push	ATW	Manual
WB Mode Switchover	×	×	○	○	×	○	○	○	○	○	○	○	○	○	○
One Push WB Trigger	×	×	○	○	×	×	×	×	×	×	×	×	○	×	×
Spot AWB ON/OFF	×	×	○	○	×	○	○	○	○	○	○	○	○	○	○
Spot AWB Setting	×	×	○	○	×	○	○	○	○	○	○	○	○	○	○
RGain Setting	×	×	○	○	×	×	×	×	×	×	×	×	×	×	○
BGain Setting	×	×	○	○	×	×	×	×	×	×	×	×	×	×	○

Exposure

Mode	Power Off	Initializing	Power On	Freeze On	MemRecall	AE Full Auto	AE Manual	Shutter Priority	Iris Priority	Wide-D	VE/Defog	HLC
AE Full Auto	×	×	○	○	×	○	○	○	○	○	○	○
AE Manual	×	×	○	○	×	○	○	○	○	×	○	○
Shutter Priority	×	×	○	○	×	○	○	○	○	×	○	○
Iris Priority	×	×	○	○	×	○	○	○	○	×	○	○
Shutter Setting	×	×	○	○	×	×	○	○	×	×	○	○
Iris Setting	×	×	○	○	×	×	○	×	○	×	○	○
Gain Setting	×	×	○	○	×	×	○	×	×	×	○	○
Auto Slow Shutter On/Off	×	×	○	○	×	○	○	○	○	○	○	○
Exposure Compensation On/Off	×	×	○	○	×	○	○	○	○	○	○	○
Exposure Compensation Setting	×	×	○	○	×	○	○	○	○	○	○	○
BackLight On/Off	×	×	○	○	×	○	×	×	×	×	○	×
SpotAE On/Off	×	×	○	○	×	○	○	○	○	×	○	×
SpotAE Setting	×	×	○	○	×	○	○	○	○	×	○	×
Defog On/Off	×	×	○	○	○	○	○	○	○	○	○	○
Minimum Shutter On/Off	×	×	○	○	×	○	○	×	○	×	○	○
VE On/Off	×	×	○	○	○	○	○	○	○	○	○	○
HLC Setting (On/Off/Mask Level)	×	×	○	○	○	○	○	○	○	×	○	○
Wide-D On/Off	×	×	○	○	○	○	×	×	×	○	○	○
Flicker Reduction	×	×	○	○	○	○	×	×	×	×	○	○

Others

Mode	Power Off	Initializing	Power On	Freeze On	MemRecall
Aperture Setting	×	×	○	○	×
LR_Reverse On/Off	×	×	○	○	×
Freeze On/Off	×	×	○	○	×
Picture Effect Setting	×	×	○	○	×
ICR On/Off	×	×	○	○	×
Auto ICR On/Off	×	×	○	○	×
Auto ICR Threshold Level Setting	×	×	○	○	×
Auto ICR Alarm On/Off	○	○	○	○	○
Display On/Off	×	×	○	○	○
Mute On/Off	×	×	○	○	○
Title Setting	×	×	○	○	○
Mask On/Off	×	×	○	○	○
Mask Setting	×	×	○	○	○
MD On/Off	×	×	○	○	○
MD Window Setting	×	×	○	○	○
MD Function Setting	×	×	○	○	○
ID Write	×	×	○	○	○
Memory Save	×	×	○	○	×
Register Value Setting	×	×	○	○	×
NR Level Setting	×	×	○	○	○
Chroma Suppress	×	×	○	○	○
Color Gain	×	×	○	○	○
Color Hue	×	×	○	○	○
Contrast Adjustment	×	×	○	○	○
Flicker Reduction	×	×	○	○	○

State transitions of the exclusive control function

Status no.	Status			Events (changes by command) and transitions					
	Wide-D	OSD	3DNR	Wide-D ON	Wide-D OFF	OSD ON	OSD OFF	3DNR ON	3DNR OFF
1	OFF	OFF	OFF	to 5	-	to 3	-	to 2	-
2	OFF	OFF	ON	to 6	-	to 4	-	-	to 1
3	OFF	ON	OFF	to 7	-	-	to 1	to 4	-
4	OFF	ON	ON	to 7	-	-	to 2	-	to 3
5	ON	OFF	OFF	-	to 1	to 7	-	to 6	-
6	ON	OFF	ON	-	to 2	to 7	-	-	to 5
7	ON	ON	OFF	-	to 3	-	to 5	to 6	-
8	ON	ON	ON	-					

Command List

VISCA/RS-232C Commands

This Manual outlines an RS-232C control protocol and command list for certain Sony cameras from which control software can be developed.

THIS CONTROL PROTOCOL AND COMMAND LIST IS PROVIDED BY SONY ON AN "AS-IS BASIS" WITHOUT WARRANTY OF ANY KIND. SONY DOES NOT WARRANT ANY PARTICULAR RESULT FROM THE USE OF THIS CONTROL PROTOCOL AND COMMAND LIST AND DISCLAIMS AND EXCLUDES ALL WARRANTIES, EXPRESS OR IMPLIED, WITH RESPECT TO THAT CONTROL PROTOCOL AND COMMAND LIST, INCLUDING, BUT NOT LIMITED TO, ANY OR ALL IMPLIED WARRANTIES OF MERCHANTABILITY OR FITNESS FOR A PARTICULAR PURPOSE. IN FACT, SONY SPECIFICALLY ACKNOWLEDGES THAT SOFTWARE DEVELOPED BASED ON THIS CONTROL PROTOCOL AND COMMAND LIST MAY CAUSE MALFUNCTION OR DAMAGE TO HARDWARE AND SOFTWARE USED WITH IT (INCLUDING SONY HARDWARE AND SOFTWARE) AND SPECIFICALLY DISCLAIMS ANY LIABILITY FOR ANY SUCH MALFUNCTION OR DAMAGE. THIS CONTROL PROTOCOL AND COMMAND LIST SHOULD BE USED WITH CAUTION.

Overview of VISCA

In VISCA, the device outputting commands, for example, a computer, is called the controller. The device receiving the commands, an FCB camera is called the peripheral device. In VISCA, up to seven peripheral devices like the FCB camera can be connected to one controller using communication conforming to the RS-232C standard. The parameters of RS-232C are as follows.

- Communication speed: 9.6 kbps/19.2 kbps/38.4 kbps/115.2 kbps
- Data bits : 8
- Start bit : 1
- Stop bit : 1
- Non parity

Flow control using XON/XOFF and RTS/CTS, etc., is not supported.

VISCA Communication Specifications

VISCA packet structure

The basic unit of VISCA communication is called a packet. The first byte of the packet is called the header and comprises the sender's and receiver's addresses. For example, the header of the packet sent to the FCB camera assigned address 1 from the controller (address 0) is hexadecimal 81h. The packet sent to the camera assigned address 2 is 82h. In the command list, as the header is 8X, input the address of the camera at X. The header of the reply packet from the camera assigned address 1 is 90h. The packet from the camera assigned address 2 is A0h.

Some of the commands for setting cameras can be sent to all devices at one time (broadcast). In the case of broadcast, the header should be hexadecimal 88h.

When the terminator is FFh, it signifies the end of the packet.

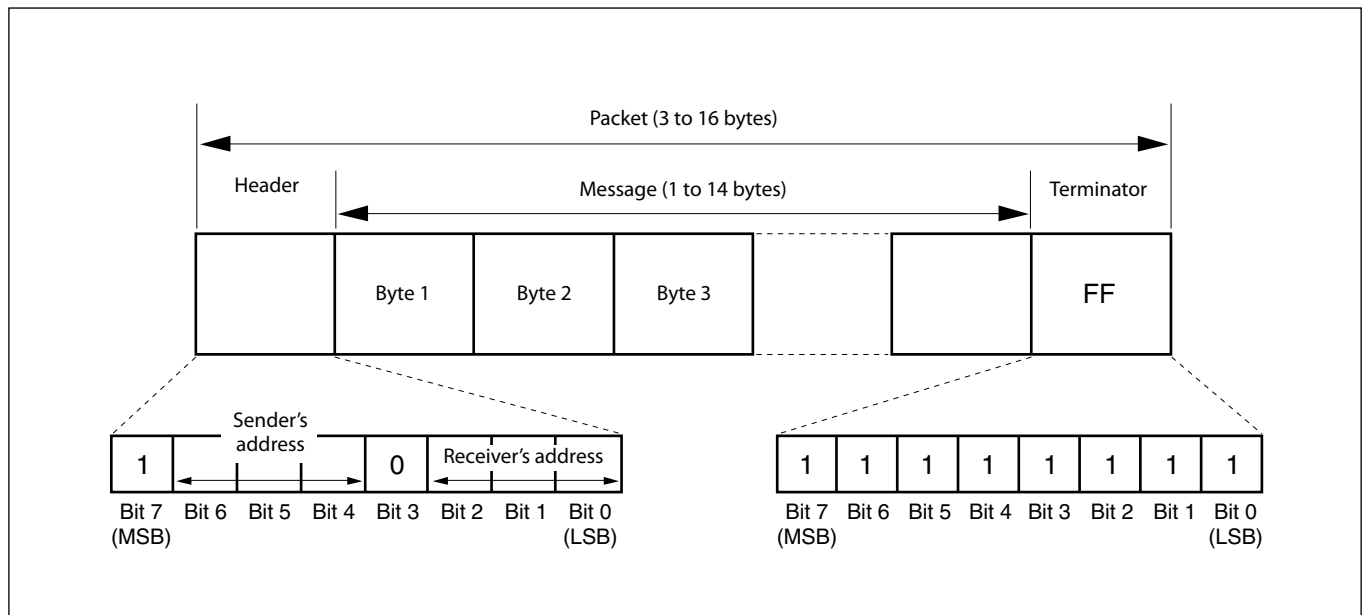

Command and inquiry

- **Command**
Sends operational commands to the FCB camera.
- **Inquiry**
Used for inquiring about the current state of the FCB camera.

	Command Packet	Note
Inquiry	8X QQ RR ... FF	QQ ¹⁾ = Command/Inquiry, RR ²⁾ = category code

¹⁾ QQ = 01 (Command), 09 (Inquiry)

²⁾ RR = 00 (Interface), 04 (camera 1), 06 (Pan/Tilt), 07 (camera 2)

X = 1 to 7: FCB camera address

Responses for commands and inquiries

● Acknowledge message

Returned by the FCB camera when it receives a command. No Acknowledge message is returned for inquiries.

● Completion message

Returned by the FCB camera when execution of commands or inquiries is completed. In the case of inquiry commands, it will contain reply data for the inquiry after the 3rd byte of the packet. If the Acknowledge message is omitted, the socket number will contain 0.

	Reply Packet	Note
Acknowledge	X0 4Y FF	Y = socket number
Completion (Commands)	X0 5Y FF	Y = socket number
Completion (Inquiries)	X0 5Y ... FF	Y = socket number

X = 9 to F: FCB camera address + 8

● Error message

When a command could not be executed or failed, an error message is returned instead of the Acknowledge message. After an Acknowledge message, an error message may be returned if the process of some command (zoom, etc.) has not been completed.

When an inquiry command could not be executed or failed, an error message is returned instead of the completion message.

Error Packet	Description
X0 6Y 01 FF	Message length error (>14 bytes)
X0 6Y 02 FF	Syntax Error
X0 6Y 03 FF	Command buffer full
X0 6Y 04 FF	Command cancelled
X0 6Y 05 FF	No socket (to be cancelled)
X0 6Y 41 FF	Command not executable

X = 9 to F: FCB camera address + 8, Y = socket number

Socket number

When command messages are sent to the FCB camera, send the next command message after waiting for the completion message or error message to return.

However to deal with advanced uses, the FCB camera has two buffers (memories) for commands, so that up to two commands including the commands currently being executed can be received. When the FCB camera receives commands, it notifies the sender which command buffer was used using the socket number of the Acknowledge message. As the completion message or error message also has a socket number, it indicates which command has ended. Even when two command buffers are being used at any one time, an FCB camera management command and some inquiry messages can be executed.

The Acknowledge message is not returned for these commands and inquiries, and only the completion message of socket number 0 is returned.

Command execution cancel

To cancel a command which has already been sent, send the Cancel command as the next command. To cancel one of any two commands which have been sent, use the cancel message.

	Cancel Packet	Note
Cancel	8X 2Y FF	Y = socket number

X = 1 to 7: FCB camera address, Y = socket number

An error message will be returned for this command, but this is not a fault. It indicates that the command has been canceled.

VISCA Device Setting Command

Before starting control of the FCB camera, be sure to send the Address command and the IF_Clear command using the broadcast function.

For VISCA network administration

- **Address**

Sets an address of a peripheral device. Use when initializing the network, and receiving the following network change message.

- **Network Change**

Sent from the peripheral device to the controller when a device is removed from or added to the network. The address must be re-set when this message is received.

	Packet	Note
Address	88 30 01 FF	Always broadcasted.
Network Change	X0 38 FF	

X = 9 to F: FCB camera address + 8

Note

Please start the camera and start sending the VISCA command after receiving the Network Change.

VISCA interface command

- **IF_Clear**

Clears the command buffers in the FCB camera and cancels the command currently being executed.

	Command Packet	Reply Packet	Note
IF_Clear	8X 01 00 01 FF	X0 50 FF	
IF_Clear (broadcast)	88 01 00 01 FF	88 01 00 01 FF	

X = 1 to 7: FCB camera board address (For inquiry packet)
X = 9 to F: FCB camera board address +8 (For reply packet)

VISCA interface and inquiry

- **CAM_VersionInq**

Returns information on the VISCA interface.

Inquiry	Inquiry Packet	Reply Packet	Description
CAM_VersionInq	8X 09 00 02 FF	Y0 50 GG GG HH HH JJ JJ KK FF	GGGG = Vender ID (0020: Sony) HHHH = Model ID 070E: FCB-EV9500L JJJJ = ROM revision KK = Maximum socket #(02)

X = 1 to 7: FCB camera address (For inquiry packet)
X = 9 to F: FCB camera address +8 (For reply packet)

VISCA Command/Acknowledge Protocol

Command	Command Message	Reply Message	Comments
General Command	81 01 04 38 02 FF (Example)	90 41 FF (Acknowledge) +90 51 FF (Completion) 90 42 FF 90 52 FF	Returns Acknowledge when a command has been accepted, and Completion when a command has been executed.
	81 01 04 38 FF (Example)	90 60 02 FF (Syntax Error)	Accepted a command which is not supported or a command lacking parameters.
	81 01 04 38 02 FF (Example)	90 60 03 FF (Command Buffer Full)	There are two commands currently being executed, and the command could not be accepted.
	81 01 04 08 02 FF (Example)	90 61 41 FF (Command Not Executable) 90 62 41 FF	Could not execute the command in the current mode.
Inquiry Command	81 09 04 38 FF (Example)	90 50 02 FF (Completion)	Acknowledge is not returned for the inquiry command.
	81 09 05 38 FF (Example)	90 60 02 FF (Syntax Error)	Accepted an incompatible command.
Address Set	88 30 01 FF	88 30 02 FF	Returned the device address to +1.
IF_Clear(Broadcast)	88 01 00 01 FF	88 01 00 01 FF	Returned the same command.
IF_Clear (For x)	8x 01 00 01 FF	z0 50 FF (Completion)	Acknowledge is not returned for this command.
Command Cancel	8x 2y FF	z0 6y 04 FF (Command Canceled)	Returned when the command of the socket specified is canceled. Completion for the command canceled is not returned.
		z0 6y 05 FF (No Socket)	Returned when the command of the specified socket has already been completed or when the socket number specified is wrong.

VISCA Camera-Issued Messages

Acknowledge/Completion Messages

	Command Messages	Comments
Acknowledge	z0 4y FF (y:Socket No.)	Returned when the command is accepted.
Completion	z0 5y FF (y:Socket No.)	Returned when the command has been executed.

z = Device address + 8

Error Messages

	Command Messages	Comments
Syntax Error	z0 60 02 FF	Returned when the command format is different or when a command with illegal command parameters is accepted.
Command Buffer Full	z0 60 03 FF	Indicates that two sockets are already being used (executing two commands) and the command could not be accepted when received.
Command Canceled	z0 6y 04 FF (y:Socket No.)	Returned when a command which is being executed in a socket specified by the cancel command is canceled. The completion message for the command is not returned.
No Socket	z0 6y 05 FF (y:Socket No.)	Returned when no command is executed in a socket specified by the cancel command, or when an invalid socket number is specified.
Command Not Executable	z0 6y 41 FF (y:Socket No.)	Returned when a command cannot be executed due to current conditions. For example, when commands controlling the focus manually are received during auto focus.

Network Change Message

	Command Message	Comments
Network Change	z0 38 FF	Issued when power is being routed.

FCB Camera Commands

Command List (1/6)

Command Set	Command	Command Packet	Comments
AddressSet	Broadcast	88 30 01 FF	Address Setting
IF_Clear	—	8x 01 00 01 FF	I/F Clear
	Broadcast	88 01 00 01 FF	
CommandCancel	—	8x 2p FF	p: Socket No. (=1 or 2)
CAM_Power	On	8x 01 04 00 02 FF	Power On/Off
	Off (Standby)	8x 01 04 00 03 FF	
CAM_Zoom	Stop	8x 01 04 07 00 FF	—
	Tele (Standard)	8x 01 04 07 02 FF	
	Wide (Standard)	8x 01 04 07 03 FF	
	Tele (Variable)	8x 01 04 07 2p FF	p=0 (Low) to 7 (High)
	Wide (Variable)	8x 01 04 07 3p FF	
	Direct	8x 01 04 47 0p 0q 0r 0s FF	pqrs: Zoom Position
CAM_DZoom	On	8x 01 04 06 02 FF	Digital Zoom On/Off
	Off	8x 01 04 06 03 FF	
	Combine Mode	8x 01 04 36 00 FF	Enhanced Optical/Digital Zoom Combined
	Separate Mode	8x 01 04 36 01 FF	Enhanced Optical/Digital Zoom Separate
	Stop	8x 01 04 06 00 FF	—
	Tele (Variable)	8x 01 04 06 2p FF	p=0 (Low) to 7 (High)
	Wide (Variable)	8x 01 04 06 3p FF	* Enabled during Separate Mode
CAM_Focus	Direct	8x 01 04 46 00 00 0p 0q FF	pq: D-Zoom Position * Enabled during Separate Mode
	Stop	8x 01 04 08 00 FF	—
	Far (Standard)	8x 01 04 08 02 FF	
	Near (Standard)	8x 01 04 08 03 FF	
	Far (Variable)	8x 01 04 08 2p FF	p=0 (Low) to 7 (High)
	Near (Variable)	8x 01 04 08 3p FF	
	Direct	8x 01 04 48 0p 0q 0r 0s FF	pqrs: Focus Position
	Auto Focus	8x 01 04 38 02 FF	AF On/Off
	Manual Focus	8x 01 04 38 03 FF	
	Auto/Manual	8x 01 04 38 10 FF	
	One Push Trigger	8x 01 04 18 01 FF	One Push AF Trigger
	Full Scan One Push Trigger	8x 01 04 18 03 FF	Full Scan One Push AF Trigger
Near Limit	8x 01 04 28 0p 0q 0r 0s FF	pqrs: Focus Near Limit Position	
CAM_AFSensitivity	Normal	8x 01 04 58 02 FF	AF Sensitivity High/Low
	Low	8x 01 04 58 03 FF	
CAM_AFMode	Normal AF	8x 01 04 57 00 FF	AF Movement Mode
	Interval AF	8x 01 04 57 01 FF	
	Zoom Trigger AF	8x 01 04 57 02 FF	
	Active/Interval Time	8x 01 04 27 0p 0q 0r 0s FF	pq: Movement Time, rs: Interval
CAM_SpotFocus	On	8x 01 05 08 02 FF	Spot Focus ON
	Off	8x 01 05 08 03 FF	Spot Focus OFF
	Set parameter	8x 01 05 69 00 0p 0q 0r 0s FF	Position/Size setting of detection frame Specifies the position of the Spot Focus at the starting point (X1, Y1) and the terminating point (X2, Y2). p: X1, q: Y1, r: X2, s: Y2
	DISPLAY	8x 01 05 15 02 FF	Spot Focus detection frame display ON
		8x 01 05 15 03 FF	Spot Focus detection frame display OFF

Command List (2/6)

Command Set	Command	Command Packet	Comments
CAM_IRCorrection	Standard	8x 01 04 11 00 FF	Focus IR compensation data switching
	IR Light	8x 01 04 11 01 FF	
CAM_ZoomFocus	Direct	8x 01 04 47 0p 0q 0r 0s 0t 0u 0v 0w FF	pqrs: Zoom Position tuvw: Focus Position
CAM_Initialize	Lens	8x 01 04 19 01 FF	Lens Initialization Start
	Camera	8x 01 04 19 03 FF	Camera reset
CAM_WB	Auto	8x 01 04 35 00 FF	Normal Auto
	Indoor	8x 01 04 35 01 FF	Indoor mode
	Outdoor	8x 01 04 35 02 FF	Outdoor mode
	One Push WB	8x 01 04 35 03 FF	One Push WB mode
	ATW	8x 01 04 35 04 FF	Auto Tracing White Balance
	Manual	8x 01 04 35 05 FF	Manual Control mode
	One Push Trigger	8x 01 04 10 05 FF	One Push WB Trigger
	Outdoor Auto	8x 01 04 35 06 FF	Outdoor auto
	Sodium Lamp Auto	8x 01 04 35 07 FF	Auto including sodium lamp source
	Sodium Lamp	8x 01 04 35 08 FF	Sodium lamp source fixed mode
	Sodium Lamp Outdoor Auto	8x 01 04 35 09 FF	Outdoor auto including sodium lamp source
CAM_SpotAWB	ON	8x 01 05 09 02 FF	Spot AWB ON
	OFF	8x 01 05 09 03 FF	Spot AWB OFF
	Set parameter	8x 01 05 6B 00 0p 0q 0r 0s FF	Position/Size setting of detection frame Specifies the position of the Spot AWB at the starting point (X1, Y1) and the terminating point (X2, Y2). p: X1, q: Y1, r: X2, s: Y2
	DISPLAY	8x 01 05 17 0p FF	Spot AWB detection frame display ON (p=2h)
			Spot AWB detection frame display OFF (p=3h)
CAM_RGain	Reset	8x 01 04 03 00 FF	Manual Control of R Gain
	Up	8x 01 04 03 02 FF	
	Down	8x 01 04 03 03 FF	
	Direct	8x 01 04 43 00 00 0p 0q FF	pq: R Gain
CAM_BGain	Reset	8x 01 04 04 00 FF	Manual Control of B Gain
	Up	8x 01 04 04 02 FF	
	Down	8x 01 04 04 03 FF	
	Direct	8x 01 04 44 00 00 0p 0q FF	pq: B Gain
CAM_AE	Full Auto	8x 01 04 39 00 FF	Auto Exposure mode
	Manual	8x 01 04 39 03 FF	Manual Control mode
	Shutter Priority	8x 01 04 39 0A FF	Shutter Priority Auto Exposure mode
	Iris Priority	8x 01 04 39 0B FF	Iris Priority Auto Exposure mode
CAM_AutoSlowShutter	On	8x 01 04 5A 02 FF	Auto Slow Shutter On/Off
	Off	8x 01 04 5A 03 FF	
CAM_Shutter	Reset	8x 01 04 0A 00 FF	Shutter Setting
	Up	8x 01 04 0A 02 FF	
	Down	8x 01 04 0A 03 FF	
	Direct	8x 01 04 4A 00 00 0p 0q FF	pq: Shutter Position
CAM_Iris	Reset	8x 01 04 0B 00 FF	Iris Setting
	Up	8x 01 04 0B 02 FF	
	Down	8x 01 04 0B 03 FF	
	Direct	8x 01 04 4B 00 00 0p 0q FF	pq: Iris Position

Command List (3/6)

Command Set	Command	Command Packet	Comments
CAM_Gain	Reset	8x 01 04 0C 00 FF	Gain Setting
	Up	8x 01 04 0C 02 FF	
	Down	8x 01 04 0C 03 FF	
	Direct	8x 01 04 4C 00 00 0p 0q FF	pq: Gain Position
	Gain Limit	8x 01 04 2C 0p FF	p: Gain Position
CAM_ExpComp	On	8x 01 04 3E 02 FF	Exposure Compensation On/Off
	Off	8x 01 04 3E 03 FF	
	Reset	8x 01 04 0E 00 FF	Exposure Compensation Amount Setting
	Up	8x 01 04 0E 02 FF	
	Down	8x 01 04 0E 03 FF	
	Direct	8x 01 04 4E 00 00 0p 0q FF	
CAM_BackLight	On	8x 01 04 33 02 FF	Back Light Compensation On/Off
	Off	8x 01 04 33 03 FF	
CAM_SpotAE	On	8x 01 04 59 02 FF	Spot Auto Exposure Setting
	Off	8x 01 04 59 03 FF	
	Set parameter	8x 01 05 6A 00 0p 0q 0r 0s FF	Position/Size setting of detection frame Specifies the position of the Spot AE at the starting point (X1, Y1) and the terminating point (X2, Y2). p: X1, q: Y1, r: X2, s: Y2
	DISPLAY	8x 01 05 16 0p FF	Spot AE detection frame display ON (p=2h)
		8x 01 05 16 0p FF	Spot AE detection frame display OFF (p=3h)
CAM_AE_Response	Direct	8x 01 04 5D pp FF	pp: Auto Exposure Response Setting (01h to 30h), initial setting: 01h
CAM_VE	On	8x 01 04 3D 06 FF	VE On
	Off	8x 01 04 3D 03 FF	Off (The Off command is the same for VE/WDR)
	Set Parameter	8x 01 04 2D 00 0q 0r 0s 00 00 00 00 FF	q: Display brightness level (0: Dark to 6: Bright) r: Brightness compensation selection (0: Very dark, 1: Dark, 2: Standard, 3: Bright) s: Compensation level (0: Low, 1: Mid, 2: High)
CAM_WD	On	8x 01 04 3D 02 FF	Wide-D On
	Off	8x 01 04 3D 03 FF	Off (The Off command is the same for VE/WDR)
	Set Parameter	8x 01 04 2D 00 0q 0r 0s 00 00 00 00 FF	q: Display brightness level (0: Dark to 6: Bright) r: Brightness compensation selection (0: Very dark, 1: Dark, 2: Standard, 3: Bright) s: Compensation level (0: Low, 1: Mid, 2: High)
CAM_Defog	On	8x 01 04 37 02 0p FF	Defog On/Off p: Defog level (1: low, 2: mid, 3: high)
	Off	8x 01 04 37 03 00 FF	
CAM_Aperture	Reset	8x 01 04 02 00 FF	Aperture Control
	Up	8x 01 04 02 02 FF	
	Down	8x 01 04 02 03 FF	
	Direct	8x 01 04 42 00 00 0p FF	
CAM_NR	Noise Reduction	8x 01 04 53 pq FF	pq: NR setting (00: Off, 01 to 05: level 1 to 5, 7F: 2D/3D NR independent setting available)
	2D/3D NR independent setting	8x 01 05 53 0p 0q FF	p: 2DNR level (0: OFF, 1 to 5: level 1 to 5) q: 3DNR level (0: OFF, 1 to 5: level 1 to 5)
CAM_Gamma	—	8x 01 04 5B 0p FF	p: Gamma Setting (0: Standard, 1: Straight)
CAM_HighSensitivity	On	8x 01 04 5E 02 FF	High Sensitivity mode On/Off
	Off	8x 01 04 5E 03 FF	

Command List (4/6)

Command Set	Command	Command Packet	Comments
CAM_LR_Reverse	On	8x 01 04 61 02 FF	LR Reverse On/Off
	Off	8x 01 04 61 03 FF	
CAM_Freeze	On	8x 01 04 62 02 FF	Freeze On/Off
	Off	8x 01 04 62 03 FF	
CAM_PictureEffect	Off	8x 01 04 63 00 FF	Picture Effect Setting
	Black & White	8x 01 04 63 04 FF	
CAM_MinShutter	On	8x 01 04 12 02 FF	pq: Minimum Shutter Position (05h to 14h)
	Off	8x 01 04 12 03 FF	
	Limit	8x 01 04 13 00 00 0p 0q FF	
CAM_PictureFlip	On	8x 01 04 66 02 FF	E-Flip On/Off
	Off	8x 01 04 66 03 FF	
CAM_ICR	On	8x 01 04 01 02 FF	ICR Mode On/Off
	Off	8x 01 04 01 03 FF	
CAM_AutoICR	On	8x 01 04 51 02 FF	Auto ICR Mode On
	On (Color)	8x 01 04 51 04 FF	Auto ICR Mode On (color)
	Off	8x 01 04 51 03 FF	Auto ICR Mode Off
	Threshold	8x 01 04 21 00 00 0p 0q FF	pq: ICR On → Off Threshold Level
CAM_AutoICRArmReply	On	8x 01 04 31 02 FF	Auto ICR switching Alarm On/Off
	Off	8x 01 04 31 03 FF	
	(Reply)	y0 07 04 31 02 FF	ICR Off → On
		y0 07 04 31 03 FF	ICR On → Off
CAM_Stabilizer	On	8x 01 04 34 02 FF	Stabilizer On/Off/HOLD
	Off	8x 01 04 34 03 FF	
	Hold	8x 01 04 34 00 FF	
	Level	8x 01 7E 04 34 0p FF	
CAM_Memory	Reset	8x 01 04 3F 00 0p FF	p: Memory Number (=0h to Fh)
	Set	8x 01 04 3F 01 0p FF	
	Recall	8x 01 04 3F 02 0p FF	
CAM_Custom	Reset	8x 01 04 3F 00 7F FF	Starts up in this mode when the power is turned on.
	Set	8x 01 04 3F 01 7F FF	
	Recall	8x 01 04 3F 02 7F FF	
CAM_MemSave	Write	8x 01 04 23 0X 0p 0q 0r 0s FF	X: 00h to 07h (Address), total 16 byte pqrs: 0000h to FFFFh (Data)
CAM_Display	On	8x 01 04 15 02 FF (8x 01 06 06 02 FF)	Display On/Off
	Off	8x 01 04 15 03 FF (8x 01 06 06 03 FF)	
	On/Off Switch	8x 01 04 15 10 FF (8x 01 06 06 10 FF)	
CAM_MultiLineTitle	Title Set1	8x 01 04 73 1L 00 nn pp qq 00 00 00 00 00 00 FF	L: Line Number, nn: H-position pp: Color, qq: Blink
	Title Set2	8x 01 04 73 2L mm nn pp qq rr ss tt uu vv ww FF	L: Line Number, mnpqrstuvw: Setting of characters (1 to 10)
	Title Set3	8x 01 04 73 3L mm nn pp qq rr ss tt uu vv ww FF	L: Line Number, mnpqrstuvw: Setting of characters (11 to 20)
	Title Clear	8x 01 04 74 1p FF	Title Setting clear (p: 0h to Ah, F= all lines)
	On	8x 01 04 74 2p FF	Title display On/Off (p: 0h to Ah, F= all lines)
	Off	8x 01 04 74 3p FF	
CAM_Mute	On	8x 01 04 75 02 FF	Muting On/Off
	Off	8x 01 04 75 03 FF	
	On/Off	8x 01 04 75 10 FF	

Command List (5/6)

Command Set	Command	Command Packet	Comments
CAM_PrivacyZone	SetMask	8x 01 04 76 mm nn 0r 0r 0s 0s FF	mm: Mask Settings nn 00: Modify, 01: New rr: W, ss: H
	Display	8x 01 04 77 pp pp pp pp FF	Mask Display On/Off pp pp pp pp: Mask Settings (0: Off, 1: On)
	SetMaskColor	8x 01 04 78 pp pp pp pp qq rr FF	pp pp pp pp: Mask Color Settings qq: Color Setting when 0 is selected rr: Color Setting when 1 is selected
	SetPanTiltAngle	8x 01 04 79 0p 0p 0p 0q 0q 0q FF	Pan/Tilt Angle Settings ppp: Pan, qq: Tilt
	SetPTZMask	8x 01 04 7B mm 0p 0p 0p 0q 0q 0q 0r 0r 0r FF	Pan/Tilt/Zoom Settings for Mask ppp: Pan, qq: Tilt, rrr: Zoom, mm: Mask Settings
	Non_InterlockMask	8x 01 04 6F mm 0p 0p 0q 0q 0r 0r 0s 0s FF	mm: Non_Interlock Mask Settings pp: X, qq: Y, rr: W, ss: H
	CenterLineOff	8x 01 04 7C 03 FF	Center Line Display Off
	CenterLineOn	8x 01 04 7C 04 FF	Center Line Display On
CAM_IDWrite	—	8x 01 04 22 0p 0q 0r 0s FF	pqr: Camera ID (=0000h to FFFh)
CAM_MD	On	8x 01 04 1B 02 FF	Motion Detection On/Off
	Off	8x 01 04 1B 03 FF	
	Function Set	8x 01 04 1C 0m 0n 0p 0q 0r 0s FF	m: Display mode n: Detection Frame Set (00h to 0Fh) pq: Threshold Level (00h to FFh) rs: Interval Time set (00h to FFh)
	Window Set	8x 01 04 1D 0m 0p 0q rr 0s FF	m: Select Detection Frame (0, 1, 2, 3) p: Start Horizontal Position (0h to Fh) q: Start Vertical Position (0h to Bh) rr: Stop Horizontal Position (01h to 10h) s: Stop Vertical Position (1h to Ch)
	Alarm (Reply)	y0 07 04 1B 0p FF	p: Detection Frame Number
CAM_Continuous ZoomPosReply	On	8x 01 04 69 02 FF	Zoom Position data Continuous Output On/Off
	Off	8x 01 04 69 03 FF	
	(Reply)	y0 07 04 69 0p 0p 0q 0q 0q 0q FF	pp: D-Zoom Position * 00: When Zoom Mode is Combine qqqq: Zoom Position
CAM_ZoomPos ReplyIntervalTimeSet	—	8x 01 04 6A 00 00 0p 0p FF	pp: Interval Time [V cycle]
CAM_Continuous FocusPosReply	On	8x 01 04 16 02 FF	Focus Position data Continuous Output On/Off
	Off	8x 01 04 16 03 FF	
	(Reply)	y0 07 04 16 00 00 0p 0p 0p 0p FF	pppp: Focus Position
CAM_FocusPosReply IntervalTimeSet	—	8x 01 04 1A 00 00 0p 0p FF	pp: Interval Time [V cycle]
CAM_RegisterValue	—	8x 01 04 24 mm 0p 0p FF	mm: Register No. (=00h to 7Fh) pp: Register Value (=00h to FFh)
CAM_ChromaSuppress	—	8x 01 04 5F pp FF	pp: Chroma Suppress setting level 00: Off 01h to 03h: On (3 levels). Effect increases as the level number increases.
CAM_ColorGain	Direct	8x 01 04 49 00 00 00 0p FF	p: Color Gain Setting 0h to Eh
CAM_ColorHue	Direct	8x 01 04 4F 00 00 00 0p FF	p: Color Hue Setting 0h to Eh
CAM_GammaOffset	Direct	8x 01 04 1E 00 00 00 0s 0t 0u FF	s: Polarity offset (0 is plus, 1 is minus) tu: Offset value (brightness) setting (00h to 40h)

Command List (6/6)

Command Set	Command	Command Packet	Comments
CAM_ContrastAdjLevel	Direct	8x 01 05 5D 01 0p 0q FF	<p>pq: 00h to FFh</p> <p>00h to 7Fh: The smaller the value is, the lower the contrast becomes.</p> <p>80h (Initial setting): No contrast adjustment</p> <p>81h to FFh: The larger the value is, the higher the contrast becomes.</p>
CAM_ExExpComp	Reset	8x 01 04 1F 0E 00 00 FF	Exposure compensation reset
	Up	8x 01 04 1F 0E 02 pp FF	<p>Exposure compensation up</p> <p>pp: Step number</p> <p>pp=00h to 7Fh (However, 00h is the same operation as 01h.)</p>
	Down	8x 01 04 1F 0E 03 pp FF	<p>Exposure compensation down</p> <p>pp: Step number</p> <p>pp=00h to 7Fh (However, 00h is the same operation as 01h.)</p>
	Direct	8x 01 04 1F 4E 00 00 0p 0q FF	<p>Set the exposure compensation to the specified level</p> <p>pp: Level</p> <p>pq=00h to FFh</p>
CAM_ExAperture	Reset	8x 01 04 1F 02 00 00 FF	Aperture control reset
	Up	8x 01 04 1F 02 02 pp FF	<p>Aperture control up</p> <p>pp: Step number</p> <p>pp=00h to 7Fh (However, 00h is the same operation as 01h.)</p>
	Down	8x 01 04 1F 02 03 pp FF	<p>Aperture control down</p> <p>pp: Step number</p> <p>pp=00h to 7Fh (However, 00h is the same operation as 01h.)</p>
	Direct	8x 01 04 1F 42 00 00 0p 0q FF	<p>Set the aperture control to the specified level</p> <p>pp: Level</p> <p>pq=00h to FFh</p>
CAM_ExAutoICR	Threshold (On→Off)	8x 01 04 1F 21 00 00 0p 0q FF	<p>pq: ICR On→Off threshold level when Auto ICR</p> <p>pq=00h to FFh</p>
	On Level	8x 01 04 1F 21 01 00 0r 0s FF	<p>pq: ICR Off→On threshold level when Auto ICR</p> <p>pq=00h to 1Ch</p>
CAM_ExColorGain	Direct	8x 01 04 1F 49 00 00 0p 0q FF	<p>Color Gain Setting</p> <p>pp: Gain setting level</p> <p>pq=00h to FFh</p>
CAM_ExColorHue	Direct	8x 01 04 1F 4F 00 00 0p 0q FF	<p>Color Hue Setting</p> <p>pp: Phase setting level</p> <p>pq=00h to FFh</p>
CAM_HLC	Parameter Set	8x 01 04 14 0p 0q FF	<p>p: HLC level (0: Off, 1: Low, 2: Mid, 3: High)</p> <p>q: HLC mask level (0: Off, 1: Low, 2: Mid, 3: High)</p>
CAM_FlickerReduction	ON	8x 01 04 32 02 FF	Flicker reduction ON/OFF
	OFF	8x 01 04 32 03 FF	

Inquiry Command List (1/4)

Inquiry Command	Command Packet	Inquiry Packet	Comments
CAM_PowerInq	8x 09 04 00 FF	y0 50 02 FF	On
		y0 50 03 FF	Off (Standby)
CAM_ZoomPosInq	8x 09 04 47 FF	y0 50 0p 0q 0r 0s FF	pqrs: Zoom Position
CAM_DZoomModeInq	8x 09 04 06 FF	y0 50 02 FF	D-Zoom On
		y0 50 03 FF	D-Zoom Off
CAM_DZoomC/SModeInq	8x 09 04 36 FF	y0 50 00 FF	Combine Mode
		y0 50 01 FF	Separate Mode
CAM_DZoomPosInq	8x 09 04 46 FF	y0 50 00 00 0p 0q FF	pq: D-Zoom Position
CAM_FocusModeInq	8x 09 04 38 FF	y0 50 02 FF	Auto Focus
		y0 50 03 FF	Manual Focus
CAM_FocusPosInq	8x 09 04 48 FF	y0 50 0p 0q 0r 0s FF	pqrs: Focus Position
CAM_FocusNearLimitInq	8x 09 04 28 FF	y0 50 0p 0q 0r 0s FF	pqrs: Focus Near Limit Position
CAM_SpotFocusModeInq	8x 09 05 08 FF	y0 50 02 FF	On
		y0 50 03 FF	Off
CAM_SpotFocusParameterInq	8x 09 05 69 00 FF	y0 50 0p 0q 0r 0s FF	Position/Size setting of detection frame The position of the Spot Focus at the starting point (X1, Y1) and the terminating point (X2, Y2). p: X1, q: Y1, r: X2, s: Y2
CAM_SpotFocusDispInq	8x 09 05 15 FF	y0 50 02 FF	Spot Focus display ON (p=2h)
		y0 50 03 FF	Spot Focus display OFF (p=3h)
CAM_AFSensitivityInq	8x 09 04 58 FF	y0 50 02 FF	AF Sensitivity Normal
		y0 50 03 FF	AF Sensitivity Low
CAM_AFModeInq	8x 09 04 57 FF	y0 50 00 FF	Normal AF
		y0 50 01 FF	Interval AF
		y0 50 02 FF	Zoom Trigger AF
CAM_AFTimeSettingInq	8x 09 04 27 FF	y0 50 0p 0q 0r 0s FF	pq: Movement Time, rs: Interval
CAM_SpotAWBModeInq	8x 09 05 09 FF	y0 50 02 FF	Spot AWB ON (p=2h)
		y0 50 03 FF	Spot AWB OFF (p=3h)
CAM_SpotAWBParameterInq	8x 09 05 6B 00 FF	y0 50 0p 0q 0r 0s FF	Position/Size setting of detection frame The position of the Spot AWB at the starting point (X1, Y1) and the terminating point (X2, Y2). p: X1, q: Y1, r: X2, s: Y2
CAM_SpotAWBDispInq	8x 09 05 17 FF	y0 50 02 FF	Spot AWB display ON (p=2h)
		y0 50 03 FF	Spot AWB display OFF (p=3h)
CAM_IRCorrectionInq	8x 09 04 11 FF	y0 50 00 FF	Standard
		y0 50 01 FF	IR Light
CAM_WBModeInq	8x 09 04 35 FF	y0 50 00 FF	Auto
		y0 50 01 FF	Indoor
		y0 50 02 FF	Outdoor
		y0 50 03 FF	One Push WB
		y0 50 04 FF	ATW
		y0 50 05 FF	Manual
		y0 50 06 FF	Outdoor Auto
		y0 50 07 FF	Sodium Lamp Auto
		y0 50 08 FF	Sodium Lamp
y0 50 09 FF	Sodium Lamp Outdoor Auto		
CAM_RGainInq	8x 09 04 43 FF	y0 50 00 00 0p 0q FF	pq: R Gain

Inquiry Command List (2/4)

Inquiry Command	Command Packet	Inquiry Packet	Comments
CAM_BGainInq	8x 09 04 44 FF	y0 50 00 00 0p 0q FF	pq: B Gain
CAM_AEModeInq	8x 09 04 39 FF	y0 50 00 FF	Full Auto
		y0 50 03 FF	Manual
		y0 50 0A FF	Shutter Priority
		y0 50 0B FF	Iris Priority
CAM_AutoSlowShutterInq	8x 09 04 5A FF	y0 50 02 FF	On
		y0 50 03 FF	Off
CAM_ShutterPosInq	8x 09 04 4A FF	y0 50 00 00 0p 0q FF	pq: Shutter Position
CAM_IrisPosInq	8x 09 04 4B FF	y0 50 00 00 0p 0q FF	pq: Iris Position
CAM_GainPosInq	8x 09 04 4C FF	y0 50 00 00 0p 0q FF	pq: Gain Position
CAM_GainLimitInq	8x 09 04 2C FF	y0 50 0q FF	p: Gain Limit
CAM_ExpCompModeInq	8x 09 04 3E FF	y0 50 02 FF	On
		y0 50 03 FF	Off
CAM_ExpCompPosInq	8x 09 04 4E FF	y0 50 00 00 0p 0q FF	pq: ExpComp Position
CAM_BackLightModeInq	8x 09 04 33 FF	y0 50 02 FF	On
		y0 50 03 FF	Off
CAM_SpotAEModeInq	8x 09 04 59 FF	y0 50 02 FF	On
		y0 50 03 FF	Off
CAM_SpotAEParameterInq	8x 09 05 6A 00 FF	y0 50 0p 0q 0r 0s FF	Position/Size setting of detection frame The position of the Spot AE at the starting point (X1, Y1) and the terminating point (X2, Y2). p: X1, q: Y1, r: X2, s: Y2
CAM_SpotAEDispInq	8x 09 05 16 FF	y0 50 02 FF	Spot AE display ON (p=2h)
		y0 50 03 FF	Spot AE display OFF (p=3h)
CAM_VEModeInq	8x 09 04 3D FF	y0 50 03 FF	Off
		y0 50 06 FF	VE On
CAM_VEParameterInq	8x 09 04 2D FF	y0 50 00 0q 0r 0s 0t 0u 00 00 FF	q: Display brightness level (0: Dark to 6: Bright) r: Brightness compensation selection (0: Very dark, 1: Dark, 2: Standard, 3: Bright) s: Compensation level (00h: Low, 01h: Mid, 02h: High) tu: Always 0
CAM_WDModeInq	8x 09 04 3D FF	y0 50 02 FF	Wide-D On
		y0 50 03 FF	Wide-D and VE Off
		y0 50 06 FF	VE On
CAM_WDParameterInq	8x 09 04 2D FF	y0 50 00 0q 0r 0s 0t 0u 00 00 FF	q: Display brightness level (0: Dark to 6: Bright) r: Brightness compensation selection (0: Very dark, 1: Dark, 2: Standard, 3: Bright) s: Compensation level (00h: Low, 01h: Mid, 02h: High) tu: Always 0
CAM_AEResponseInq	8x 09 04 5D FF	y0 50 pp FF	pp: 01h to 30h
CAM_DefogInq	8x 09 04 37 FF	y0 50 02 0p FF	p: Defog level (1: low, 2: mid, 3: high)
		y0 50 03 00 FF	Defog Off
CAM_ApertureInq	8x 09 04 42 FF	y0 50 00 00 0p 0q FF	pq: Aperture Gain
CAM_NRInq	8x 09 04 53 FF	y0 50 pq FF	pq: NR level (00: Off, 01 to 05: level 1 to 5, 7F: 2D/3D NR independent setting available)
CAM_NR2D3DInq	8x 09 05 53 FF	y0 50 0p 0q FF	p: 2D NR level (0: Off, 01 to 05: level 1 to 5) q: 3D NR level (0: Off, 01 to 05: level 1 to 5)
CAM_GammaInq	8x 09 04 5B FF	y0 50 0p FF	Gamma p: 00h, 01h
CAM_HighSensitivityInq	8x 09 04 5E FF	y0 50 02 FF	On
		y0 50 03 FF	Off

Inquiry Command List (3/4)

Inquiry Command	Command Packet	Inquiry Packet	Comments
CAM_LR_ReverseModeInq	8x 09 04 61 FF	y0 50 02 FF	On
		y0 50 03 FF	Off
CAM_FreezeModeInq	8x 09 04 62 FF	y0 50 02 FF	On
		y0 50 03 FF	Off
CAM_PictureEffectModeInq	8x 09 04 63 FF	y0 50 00 FF	Off
		y0 50 04 FF	Black & White
CAM_PictureFlipModeInq	8x 09 04 66 FF	y0 50 02 FF	On
		y0 50 03 FF	Off
CAM_ICRModeInq	8x 09 04 01 FF	y0 50 02 FF	On
		y0 50 03 FF	Off
CAM_AutoICRModeInq	8x 09 04 51 FF	y0 50 02 FF	On
		y0 50 04 FF	Auto ICR Mode On (color)
		y0 50 03 FF	Off
CAM_AutoICRThresholdInq	8x 09 04 21 FF	y0 50 00 00 0p 0q FF	pq: ICR On → Off Threshold Level
CAM_AutoICRAAlarmReplyInq	8x 09 04 31 FF	y0 50 02 FF	On
		y0 50 03 FF	Off
CAM_MemoryInq	8x 09 04 3F FF	y0 50 pp FF	pp: Memory number recalled last
CAM_MemSaveInq	8x 09 04 23 0X FF	y0 50 0p 0q 0r 0s FF	X: 00h to 07h (Address) pqrs: 0000h to FFFFh (Data)
CAM_DisplayModeInq	8x 09 04 15 FF (8x 09 06 06 FF)	y0 50 02 FF	On
		y0 50 03 FF	Off
CAM_StabilizerModeInq	8x 09 04 34 FF	y0 05 02 FF	On
		y0 05 03 FF	Off
		y0 05 00 FF	Hold
CAM_StabilizerLevelInq	8x 09 7E 04 34 FF	y0 50 0p FF	P: 2=Super 3=Super+
CAM_MuteModeInq	8x 09 04 75 FF	y0 50 02 FF	On
		y0 50 03 FF	Off
CAM_PrivacyDisplayInq	8x 09 04 77 FF	y0 50 pp pp pp pp FF	pp pp pp pp: Mask Display (0: Off, 1: On)
CAM_PrivacyPanTiltInq	8x 09 04 79 FF	y0 50 0p 0p 0p 0q 0q 0q FF	ppp: Pan qqq: Tilt
CAM_PrivacyPTZInq	8x 09 04 7B mm FF	y0 50 0p 0p 0p 0q 0q 0q 0r 0r 0r 0r FF	mm: Mask Settings ppp: Pan qqq: Tilt rrrr: Zoom
CAM_PrivacyMonitorInq	8x 09 04 6F FF	y0 50 pp pp pp pp FF	pp pp pp pp: Mask is displayed now.
CAM_IDInq	8x 09 04 22 FF	y0 50 0p 0q 0r 0s FF	pqrs: Camera ID
CAM_VersionInq	8x 09 00 02 FF	y0 50 00 20 mn pq rs tu vw FF	mnpq: Model Code 070E: FCB-EV9500L rstu: ROM version vw: Socket Number (=02)
CAM_MDModeInq	8x 09 04 1B FF	y0 50 02 FF	On
		y0 50 03 FF	Off
CAM_MDFunctionInq	8x 09 04 1C FF	y0 50 0m 0n 0p 0q 0r 0s FF	m: Display mode n: Detection Frame Set (00h to 0Fh) pq: Threshold Level (00h to FFh) rs: Interval Time set (00h to FFh)
CAM_MDWindowInq	8x 09 04 1D 0m FF	y0 50 0p 0q rr 0s FF	m: Select Detection Frame (0, 1, 2, 3) p: Start Horizontal Position (0h to Fh) q: Start Vertical Position (0h to Bh) rr: Stop Horizontal Position (01h to 10h) s: Stop Vertical Position (1h to Ch)
CAM_ContinuousZoomPosReplyModeInq	8x 09 04 69 FF	y0 50 02 FF	On
		y0 50 03 FF	Off
CAM_ZoomPosReplyIntervalTimeInq	8x 09 04 6A FF	y0 50 00 00 0p 0p FF	pp: Interval Time

Inquiry Command List (4/4)

Inquiry Command	Command Packet	Inquiry Packet	Comments
CAM_Continuous FocusPosReplyModeInq	8x 09 04 16 FF	y0 50 02 FF	On
		y0 50 03 FF	Off
CAM_FocusReply IntervalTimeInq	8x 09 04 1A FF	y0 50 00 00 0p 0p FF	pp: Interval Time
CAM_RegisterValueInq	8x 09 04 24 mm FF	y0 50 0p 0p FF	mm: Register No. (=00h to 7Fh) pp: Register Value (=00h to FFh)
CAM_ChromaSuppressInq	8x 09 04 5F FF	y0 50 pp FF	pp: Chroma Suppress setting level
CAM_ColorGainInq	8x 09 04 49 FF	y0 50 00 00 00 0p FF	p: Color Gain Setting 0h to Eh
CAM_ColorHueInq	8x 09 04 4F FF	y0 50 00 00 00 0p FF	p: Color Hue Setting 0h to Eh
CAM_TempInq	8x 09 04 68 FF	Y0 50 00 00 0p 0q FF	pq: Lens Temperature
CAM_GammaOffsetInq	8x 09 04 1E FF	y0 50 00 00 00 0s 0t 0u FF	s: Polarity offset (0 is plus, 1 is minus) tu: Offset s=0 (00h to 40h) Offset s=1 (00h to 40h)
CAM_ContrastAdjLevelInq	8x 09 05 5D FF	y0 50 0p 0q FF	pq: Contrast adjustment value (low) 00h to 80h (no adjustment) to FFh (high)
CAM_ExExpCompPosInq	8x 09 04 1F 4E FF	y0 50 00 00 0p 0q FF	pq: Exposure compensation level pq = 00h to FFh
CAM_ExApertureInq	8x 09 04 1F 42 FF	y0 50 00 00 0p 0q FF	pq: Aperture control level pq=00h to FFh
CAM_ExColorGainInq	8x 09 04 1F 49 00 FF	y0 50 0p 0q FF	pq: Gain setting level pq=00h to FFh
CAM_ExColorHueInq	8x 09 04 1F 4F 00 FF	y0 50 0p 0q FF	pq: Phase setting level pq=00h to FFh
CAM_ExAutoICRThresholdInq	8x 09 04 1F 21 00 FF	y0 50 00 00 0p 0q FF	pq: ICR On→Off threshold level when Auto ICR pq=00h to FFh
CAM_ExAutoICROnLevelInq	8x 09 04 1F 21 01 FF	y0 50 00 00 0p 0q FF	pq: ICR Off→On threshold level when Auto ICR pq=00h to 1Ch
CAM_MinShutterInq	8x 09 04 12 FF	y0 50 02 FF	On
		y0 50 03 FF	Off
CAM_MinShutterLimitInq	8x 09 04 13 FF	y0 50 00 00 0p 0q FF	pq: MinShutter Position
CAM_HLCInq	8x 09 04 14 FF	y0 50 0p 0q FF	p: HLC level (0: OFF, 1: Low, 2: Mid, 3: High) q: HLC mask level (0: OFF, 1: Low, 2: Mid, 3: High)
CAM_FlickerReductionInq	8x 09 04 32 FF	y0 50 02 FF	ON
		y0 50 03 FF	OFF
CAM_FlickerDetectionInq	8x 09 05 41 01 FF	y0 50 00 FF	p=0h: Indefinite (Initial setting)
		y0 50 01 FF	p=1h: Without flicker
		y0 50 02 FF	p=2h: With flicker

Block Inquiry Command List

Lens Control System Inquiry Commands Command Packet 8x 09 7E 7E 00 FF

Byte	Bit	Comments	Byte	Bit	Comments	Byte	Bit	Comments	
0	7	Destination Address	6	7	0	12	7	0	
	6			0	6		0		
	5			0	5		0		
	4			0	4		0		
	3	Source Address		3	Focus Near Limit (H)		3	0	
	2			2			0		
	1			1			0		
	0			0			0		
1	7	0 Completion Message (50h)	7	7	0		13	7	0
	6	1		6	0			6	0
	5	0		5	0			5	DZoomMode 0: Combine 1: Separate
	4	1		4	0			4	0: Normal 1: Interval 2: Zoom Trigger
	3	0		3	Focus Near Limit (L)	3		AF Sensitivity 0: Low 1: Normal	
	2	0		2		0			2
	1	0		1		0		1	Focus Mode 1: Auto 0: Manual
	0	0		0		0		0	0
2	7	0	8	7	0	14		7	0
	6	0		6	0			6	0
	5	0		5	0			5	0
	4	0		4	0			4	0
	3	Zoom Position (HH)		3	Focus Position (HH)		3	Low Contrast Detection 1: Yes 0: No	
	2			2			2		Camera Memory Recall 1: Executing 0: Stopped
	1			1			1		
	0			0			0		0
3	7	0	9	7	0		15	7	1 Terminator (FFh)
	6	0		6	0			6	1
	5	0		5	0			5	1
	4	0		4	0			4	1
	3	Zoom Position (HL)		3	Focus Position (HL)	3		1	
	2			2		2		1	
	1			1		1		1	
	0			0		0		1	
4	7	0	10	7	0	15		0	1
	6	0		6	0			6	1
	5	0		5	0			5	1
	4	0		4	0			4	1
	3	Zoom Position (LH)		3	Focus Position (LH)		3	1	
	2			2			2	1	
	1			1			1	1	
	0			0			0	1	
5	7	0	11	7	0		15	0	1
	6	0		6	0			6	1
	5	0		5	0			5	1
	4	0		4	0			4	1
	3	Zoom Position (LL)		3	Focus Position (LL)	3		1	
	2			2		2		1	
	1			1		1		1	
	0			0		0		1	

Camera Control System Inquiry Commands Command Packet 8x 09 7E 7E 01 FF

Byte	Bit	Comments	Byte	Bit	Comments	Byte	Bit	Comments	
0	7	Destination Address	6	7	0	11	7	0	
	6			0	Iris Position				
	5			0					
	4			0					
	3	Source Address		3			WB Mode	0	4
	2			2					
	1			1					
	0			0					
1	7	0 Completion Message (50h)	7	7	0	12	7	0	
	6	1		6	0		Gain Position		
	5	0		5	0				
	4	1		4	0				
	3	0		Aperture Gain	3			0	
	2	0					2		
	1	0					1		
	0	0					0		
2	7	0	8	7	0	13	7	0	
	6	0		6	0		Exposure Mode		
	5	0		5	0				
	4	0		4	R Gain (H)				
	3	R Gain (H)		3				Exposure Mode	0
	2			2					
	1			1					
	0			0					
3	7	0	9	7	0	14	7	0	
	6	0		6	Spot Focus 1: On 0: Off		Exposure Comp. Position		
	5	0		5	0				
	4	0		4	VE 1: On 0: Off Wide-D (1: Other than Off, 0: Off)				
	3	R Gain (L)		3	Spot AE 1: On 0: Off			0	
	2			2	Back Light 1: On 0: Off				
	1			1	Exposure Comp. 1: On 0: Off				
	0			0	Slow Shutter 1: On 0: Off				
4	7	0	10	7	0	15	7	1 Terminator (FFh)	
	6	0		6	Spot AWB 1: On 0: Off		Shutter Position		
	5	0		5	0				
	4	0		4	B Gain (H)				
	3	B Gain (H)		3				Shutter Position	1
	2			2					
	1			1					
	0			0					
5	7	0	5	7	0	5	7	0	
	6	0		6	0		B Gain (L)		
	5	0		5	0				
	4	0		4	0				
	3	B Gain (L)		3	B Gain (L)			1	
	2			2					
	1			1					
	0			0					

Other Inquiry Commands Command Packet 8x 09 7E 7E 02 FF

Byte	Bit	Comments	Byte	Bit	Comments	Byte	Bit	Comments	
0	7	Destination Address	6	7	0	12	7	0	
	6			0	6		0		
	5			0	5		0		
	4			0	4		Memory 1: Provided 0: Not provided		
	3	Source Address		3	0		3	0	
	2			0	2		ICR 1: Provided 0: Not provided		
	1			0	1		Stabilizer 1: Provided 0: Not provided		
	0			0	0		System 1: 1/50, 1/25 0: 1/60, 1/30		
1	7	0 Completion Message (50h)	7	7	0		13	7	0
	6	1		6	0			6	0
	5	0		5	0			5	0
	4	1		4	0			4	0
	3	0		3	0	3		0	
	2	0		2	0	2		0	
	1	0		1	0	1		0	
	0	0		0	0	0		0	
2	7	0	8	7	0	14		7	0
	6	0		6	0			6	0
	5	0		5	0			5	0
	4	0		4	0			4	0
	3	Auto ICR Alarm (1: On, 0: Off)		3	Camera ID (HH)		3	0	
	2	Auto ICR 3: color		2			0		
	1	Auto ICR 2: On 0: Off		1			0		
	0	Power 1: On 0: Off		0			0		
3	7	0	9	7	0		15	7	1 Terminator (FFh)
	6	Stabilizer 1: On 0: Off		6	0			6	1
	5	Stabilizer Hold 1: Hold 0: Off		5	0			5	1
	4	ICR 1: On 0: Off		4	0			4	1
	3	Freeze 1: On 0: Off		3	Camera ID (HL)	3		1	
	2	LR Reverse 1: On 0: Off		2		1			
	1	Stabilizer Level		1		1			
	0	2=Super 3=Super+		0		1			
4	7	0	10	7	0	15		1	1
	6	0		6	0			0	1
	5	Privacy Zone 1: On 0: Off		5	0			7	1
	4	Mute 1: On 0: Off		4	0			6	1
	3	Title Display 1: On 0: Off		3	Camera ID (LH)		5	1	
	2	Display 1: On 0: Off		2			1		
	1	0		1			1		
	0	0		0			1		
5	7	0	11	7	0		15	1	1
	6	0		6	0			0	1
	5	0		5	0			7	1
	4	0		4	0			6	1
	3	Picture Effect Mode		3	Camera ID (LL)	3		1	
	2			1					
	1			1					
	0			0					

Extended Function1 Query Command Command Packet 8x 09 7E 7E 03 FF

Byte	Bit	Comments	Byte	Bit	Comments	Byte	Bit	Comments			
0	7	Destination Address	6	7	0	11	7	0			
	6			0	6		Color Gain (0h to Eh)				
	5			0	5			Advanced Privacy (1: Provided, 0: Not provided)			
	4			0	4				Reserved		
	3	Source Address		3	AF Interval Time (H)					3	E-Flip (1: Provided, 0: Not provided)
	2			2			12	2	AE Response		
1	1		1	AF Interval Time (L)				1		0	
0	0	0	0								
1	7	0 Completion Message (50h)	7		7		0	12	7		0
	6	1		6	0		6		0		
	5	0		5	0		5		0		
	4	1		4	0	4	AE Response				
	3	0		3	AF Interval Time (L)	3			0		
	2	0		2		2				13	2
	1	0		1		1	Gamma				
	0	0		0	0	0					
2	7	0	8	7	0	13		7	0		
	6	0		6	0		6	Gamma			
	5	0		5	0		5		0		
	4	0		4	0		4				
	3	Digital Zoom Position (H)		3	0		3	0			
	2			2	0						
	1			1	0						
	0	0		0	0		0				
3	7	0	9	7	0	14	7	0			
	6	0		6	0		6	Chroma Suppress			
	5	0		5	0		5		Gain Limit		
	4	0		4	0		4				
	3	Digital Zoom Position (L)		3	0		3	0			
	2			2	0						
	1			1	0						
	0	0		0	0		0				
4	7	0	10	7	0	15	7	1 Terminator (FFh)			
	6	0		6	0		6	1			
	5	0		5	0		5	1			
	4	0		4	0		4	1			
	3	AF Activation Time (H)		3	0		3	1			
	2			2	MD (1: On, 0: Off)		2	1			
	1			1	0		1	1			
	0	0		0	E-Flip (1: On, 0: Off)		0	1			
5	7	0	10	7	0	15	0	1			
	6	0		6	0		6	1			
	5	0		5	0		5	1			
	4	0		4	0		4	1			
	3	AF Activation Time (L)		3	0		3	1			
	2			2	1		1				
	1			1	1		1				
	0	0		0	1		0	1			

Extended Function2 Query Command Command Packet 8x 09 7E 7E 04 FF

Byte	Bit	Comments	Byte	Bit	Comments	Byte	Bit	Comments		
0	7	Destination Address	6	7	0	11	7	0		
	6			0	6		0			
	5			0	5		0			
	4			0	4		0			
	3	Source Address		3	0		3	0		
	2			0	2		0			
	1			0	1		0			
	0			0	0		0			
1	7	0 Completion Message (50h)	7	7	0	12	7	0		
	6	1		6	0		6	0		
	5	0		5	0		5	0		
	4	1		4	0		4	0		
	3	0		3	0		3	0		
	2	0		2	0		2	0		
	1	0		1	0		1	0		
	0	0		0	Defog 0: Off 1: On		0	0		
2	7	0	8	7	0	13	7	0		
	6	0		6	0		6	0		
	5	0		5	0		5	0		
	4	0		4	0		4	0		
	3	0		3	0		3	0		
	2	0		2	0		2	0		
	1	Wide-D 0: Off 1: On 2: VE On		1	Defog Level 1: low 2: mid 3: high		1	0	1	0
	0			0			0	0		
3	7	0	9	7	0	14	7	0		
	6	0		6	0		6	0		
	5	0		5	0		5	0		
	4	0		4	0		4	0		
	3	0		3	0		3	0		
	2	0		2	0		2	0		
	1	0		1	0		1	0		
	0	0		0	0		0	0		
4	7	0	10	7	0	15	7	1 Terminator (FFh)		
	6	0		6	0		6	1		
	5	0		5	0		5	1		
	4	0		4	0		4	1		
	3	0		3	0		3	1		
	2	Display brightness level setting 0: Dark to 6: Bright		2	0		2	1		
	1			0	1		1			
	0	0		0	0		0	1		
5	7	0	5	7	0	5	7	0		
	6	0		6	0		6	0		
	5	0		5	0		5	0		
	4	0		4	0		4	0		
	3	0		3	0		3	0		
	2	0		2	0		2	0		
	1	Brightness compensation selection 0: Very dark 1: Dark 2: Standard 3: Bright		1	0		1	0		
	0			0	0		0			

Extended Function3 Query Command Command Packet 8x 09 7E 7E 05 FF

Byte	Bit	Comments	Byte	Bit	Comments	Byte	Bit	Comments			
0	7	Destination Address	6	7	0	11	7	0			
	6			6	SpotFocus (terminating point)		6	Reserved			
	5			5	SpotFocus (terminating point)		5				
	4			4			4				
	3	Source Address		3	3		SpotFocus (terminating point)		3	3	Reserved
	2			2	2		SpotFocus (terminating point)	2	2	Reserved	
	1			1	1		SpotFocus (terminating point)	1	1	Reserved	
	0			0	0		SpotFocus (terminating point)	0	0	Reserved	
1	7	0 Completion Message (50h)	7	7	0	12	7	0			
	6	1		6	SpotAWB (starting point)		6	Reserved			
	5	0		5			5				
	4	1		4	4		SpotAWB (starting point)		4	4	Reserved
	3	0		3	3		SpotAWB (starting point)		3	3	Reserved
	2	0		2	2			2	SpotAWB (starting point)	2	2
	1	0		1	1		SpotAWB (starting point)	1	1	Reserved	
	0	0		0	0		SpotAWB (starting point)	0	0	Reserved	
2	7	0	8	7	0	13	7	0			
	6	0		6	SpotAWB (terminating point)		6	Reserved			
	5	0		5			5				
	4	0		4	4		SpotAWB (terminating point)		4	4	Reserved
	3	Color Hue (0h to Eh)		3	3		SpotAWB (terminating point)		3	3	Reserved
2	2		2	SpotAWB (terminating point)	2	2		Reserved			
1	1		1	SpotAWB (terminating point)	1	1	Reserved				
0	0	0	0	SpotAWB (terminating point)	0	0	Reserved				
3	7	0	9	7	0	14	7	0			
	6	SpotAE (starting point)		6	Reserved		6	Reserved			
	5			5			5				
	4			4			4				
	3	SpotAE (starting point)		3			3		SpotAE (starting point)	3	3
2	2		2	SpotAE (starting point)	2	2	Reserved				
1	1	1	SpotAE (starting point)	1	1	Reserved					
0	0	0	0	SpotAE (starting point)	0	0	Reserved				
4	7	0	10	7	0	15	7	1 Terminator (FFh)			
	6	SpotAE (terminating point)		6	Reserved		6	1			
	5			5			5	1			
	4			4			4	1			
	3	SpotAE (terminating point)		3			3	SpotAE (terminating point)	3	1	
	2			2	2		SpotAE (terminating point)	2	1		
	1			1	1		SpotAE (terminating point)	1	1		
0	0		0	SpotAE (terminating point)	0	1					
5	7	0	5	7	0	5	7	0			
	6	SpotFocus (starting point)		6	Reserved		6	Reserved			
	5			5			5				
	4			4			4				
	3	SpotFocus (starting point)		3			3		SpotFocus (starting point)	3	1
2	2		2	SpotFocus (starting point)	2	1					
1	1	1	SpotFocus (starting point)	1	1						
0	0	0	0	SpotFocus (starting point)	0	1					

VISCA Command Setting Values

Exposure control (1/2)

		59.94/29.97 mode	50/25 mode
Shutter Speed	15	1/10000	1/10000
	14	1/6000	1/6000
	13	1/4000	1/3500
	12	1/3000	1/2500
	11	1/2000	1/1750
	10	1/1500	1/1250
	0F	1/1000	1/1000
	0E	1/725	1/600
	0D	1/500	1/425
	0C	1/350	1/300
	0B	1/250	1/215
	0A	1/180	1/150
	09	1/125	1/120
	08	1/100	1/100
	07	1/90	1/75
	06	1/60	1/50
	05	1/30	1/25
	04	1/15	1/12
	03	1/8	1/6
	02	1/4	1/3
01	1/2	1/2	
00	1/1	1/1	

Iris	11	F1.6
	10	F2
	0F	F2.4
	0E	F2.8
	0D	F3.4
	0C	F4
	0B	F4.8
	0A	F5.6
	09	F6.8
	08	F8
	07	F9.6
	06	F11
05	F14	

		High Sensitivity mode		Step
		OFF	ON	
Gain	0F	50.0 dB	70.0 dB	28
	0E	46.4 dB	65.0 dB	26
	0D	42.9 dB	60.0 dB	24
	0C	39.3 dB	55.0 dB	22
	0B	35.7 dB	50.0 dB	20
	0A	32.1 dB	45.0 dB	18
	09	28.6 dB	40.0 dB	16
	08	25.0 dB	35.0 dB	14
	07	21.4 dB	30.0 dB	12
	06	17.9 dB	25.0 dB	10
	05	14.3 dB	20.0 dB	8
	04	10.7 dB	15.0 dB	6
	03	7.1 dB	10.0 dB	4
	02	3.6 dB	5.0 dB	2
	01	0 dB	0 dB	0

		High Sensitivity mode		Step
		OFF	ON	
Gain Limit	0F	50.0 dB	70.0 dB	28
	0E	46.4 dB	65.0 dB	26
	0D	42.9 dB	60.0 dB	24
	0C	39.3 dB	55.0 dB	22
	0B	35.7 dB	50.0 dB	20
	0A	32.1 dB	45.0 dB	18
	09	28.6 dB	40.0 dB	16
	08	25.0 dB	35.0 dB	14
	07	21.4 dB	30.0 dB	12
	06	17.9 dB	25.0 dB	10
	05	14.3 dB	20.0 dB	8
	04	10.7 dB	15.0 dB	6

Exposure control (2/2)

Exposure Comp.	0E	+7	+10.5 dB
	0D	+6	+9 dB
	0C	+5	+7.5 dB
	0B	+4	+6 dB
	0A	+3	+4.5 dB
	09	+2	+3 dB
	08	+1	+1.5 dB
	07	0	0 dB
	06	-1	-1.5 dB
	05	-2	-3 dB
	04	-3	-4.5 dB
	03	-4	-6 dB
	02	-5	-7.5 dB
	01	-6	-9 dB
	00	-7	-10.5 dB

**Zoom Ratio and Zoom Position
(for reference)**

Enhanced Optical Zoom Ratio	Enhanced Optical Zoom Position Data
1×	0000
2×	1311
3×	1C33
4×	2202
5×	2623
6×	294E
7×	2BDD
8×	2DFF
9×	2FD2
10×	3168
11×	32CE
12×	340F
13×	3531
14×	3638
15×	372A
16×	3808
17×	38D5
18×	3995
19×	3A47
20×	3AED
21×	3B8A
22×	3C1D
23×	3CA8
24×	3D2C
25×	3DA9
26×	3E22
27×	3E98
28×	3F0D
29×	3F85
30×	4000

Digital Zoom Combine mode

Digital Zoom Ratio	Digital Zoom Position Data
1×	4000
2×	6000
3×	6A80
4×	7000
5×	7300
6×	7540
7×	76C0
8×	7800
9×	78C0
10×	7980
11×	7A00
12×	7AC0

Zoom Separate mode

Digital Zoom Ratio	Digital Zoom Position Data
1×	00
2×	80
3×	AA
4×	C0
5×	CC
6×	D5
7×	DB
8×	E0
9×	E3
10×	E6
11×	E8
12×	EB

Lens control

Zoom Position	0000 to 4000 to 7AC0 Wide end Tele end Digital Tele end	
Focus Position	1000 to F000 Far end Near end	
Focus Near Limit	1000: Over Inf 2000: 12 m 3000: 6 m 4000: 4 m 5000: 3 m 6000: 2.4 m 7000: 2 m 8000: 1.7 m 9000: 1.5 m A000: 1.3 m B000: 1.2 m C000: 61 cm D000: 33 cm (initial setting) E000: 20 cm F000: 10 cm	As the distance on the left will differ due to temperature characteristics, etc., use as approximate values. *The lower 1 byte is fixed at 00.

Temperature Reading Conversion Value (Reference Value)

Reading Value pq (hex)	Temperature Conversion Value (°C)
FB	-8 to -2
00	-3 to +3
0A	7 to 13
14	17 to 23
1E	27 to 33
28	37 to 43
32	47 to 53
3C	57 to 63

Wide/Tele Limit Setting

Wide/Tele Limit Setting Value	Wide Limit		Tele Limit	
	Zoom Position	Zoom Ratio	Zoom Position	Zoom Ratio
00	0000	1	4000	30
10	00C4	1.02	3F3B	28.38
20	0188	1.05	3E77	26.72
30	024C	1.08	3DB3	25.08
40	0310	1.11	3CEF	23.53
50	03D4	1.13	3C2B	22.1
60	0498	1.16	3B67	20.77
70	055C	1.19	3AA3	19.55
80	0620	1.23	39DF	18.41
90	06E4	1.26	391B	17.36
A0	07A8	1.29	3857	16.37
B0	086C	1.33	3793	15.46
C0	0930	1.37	36CF	14.61
D0	09F4	1.4	360B	13.82
E0	0AB8	1.44	3547	13.08
F0	0B7C	1.49	3483	12.39
FF	0C33	1.53	33CC	11.78

Register Setting

Register name	Register No.	Setting value		Setting value reflection timing*1
VISCA Baud Rate	00	00 (Initial Setting)	9600 bps	Reflected after camera reset
		01	19200 bps	
		02	38400 bps	
		03	115200 bps	
LVDS Mode	74	00 (Initial Setting)	Single output	Reflected after camera reset
		01	Double output	
Monitoring Mode	72	01	1080i/59.94	Reflected after camera reset
		02	1080i/60	
		04	1080i/50	
		06	1080p/29.97	
		07	1080p/30	
		08	1080p/25	
		09	720p/59.94	
		0A	720p/60	
		0B	Reserved	
		0C	720p/50	
		0D	Reserved	
		0E	720p/29.97	
		0F	720p/30	
		10	Reserved	
		11	720p/25	
		Zoom Limit	50	
00-FF (Initial Setting: 00)	Tele Limit (0: Disabled)			
D-Zoom Max	52	00-EB (Initial Setting: EB)	Max. digital zoom ratio = $256 \div (256 - \text{Value})$	Reflected after camera reset
StableZoom	53	00 (Initial Setting: 00)	OFF	Immediate reflection
		01	ON	
FocusTrace @ZoomDirect	54	00 (Initial Setting: 01)	Off On	Reflected after camera reset
FocusOffset @DomeCover	55	00-FF (Initial Setting: 00)	00: None to FF: Max.	Reflected after camera reset
AE Parameter Change During VE On, Defog On	58	00 (Initial Setting)	OFF	Immediate reflection
		01	ON	
Auto Slow Shutter Limit	59	01	1/30	Immediate reflection
		02	1/15	
		03	1/8	
		04	1/4	
		(Initial Setting)		
		05	1/2	
06	1/1			

Register name	Register No.	Setting value		Setting value reflection timing*1
Extended Normal Shutter	5A	00 (Initial Setting)	OFF	Immediate reflection
		01	Allowed up to 1/30	
		02	Allowed up to 1/15	
		03	Allowed up to 1/8	
		04	Allowed up to 1/4	
		05	Allowed up to 1/2	
		06	Allowed up to 1/1	
Defog Limit	5B	00-FF (Initial Setting: 55)	Defog level Low Limit	Immediate reflection
	5C	00-FF (Initial Setting: AA)	Defog level Mid Limit	
	5D	00-FF (Initial Setting: FF)	Defog level High Limit	
Extended Mode	5F	00 (Initial Setting)	OFF	Immediate reflection
		bit: 0 Exposure compensation Extended 256 levels On/Off bit: 1 Aperture Extended 256 levels On/Off bit: 2 Color Gain/Hue Extended 256 levels On/Off bit: 3 Auto ICR Off → On * For all of bit, 1 is to activate, 0 is Off		
Spot Light Avoidance	20	00 (Initial Setting: 00)	Off	Immediate reflection
		1	On	

*1: Timing to reflect register setting value changes

- Reflect after camera reset: After the setting value is changed, changes are reflected following camera reset by "Camera reset command" or "Camera power supply turned OFF and then ON again".
- Reflect immediately: Changes are reflected immediately after the setting value is changed.

Specifications

Imager	1/1.8 Type STARVIS CMOS Sensor	Back light compensation	On/Off
Picture elements	4170K pixels	Electronic shutter speed	1/1 sec to 1/10000 sec (22 steps)
Lens	f= 6.5 mm (WIDE) to 162.5 mm	White Balance	Auto, ATW, Indoor, Outdoor, One Push WB, Manual WB, Outdoor Auto, Sodium Vapor Lamp (Fix/Auto/Outdoor Auto)
(Typical value)	(TELE), F1.6 to F4.8	Gain	Auto/Manual (0 to 50.0 dB (0 to 28 step)) Max. Gain Limit (10.7 to 50.0 dB (6 to 28 step))
	Zoom movement speed	Wide Dynamic Range Mode	On/Off
	WIDE – TELE	Noise Reduction	On/Off (level 5 to 1 / Off, 6 steps)
	5.3 sec (Focus Tracking On)	Defog	On/Off (low, mid, high)
	2.8 sec (Focus Tracking Off)	Aperture control	16 steps
	WIDE – Digital TELE (Digital 12×)	Preset	16-POSITIONS
	6.6 sec (29.97p/59.94p mode)	Camera control	VISCA protocol (CMOS 3.3 V level, 5.5 V tolerant)
	6.9 sec (25p/50p mode)		9.6 kbps, 19.2 kbps, 38.4 kbps, 115.2 kbps, Stop bit, 1 bit
	Digital WIDE – Digital TELE (Digital 12×)	Video Output	Digital (LVDS)
	1.4 sec (29.97p/59.94p mode)	Storage temperature/Humidity	-20 °C to +60 °C (-4 °F to +140 °F)/ 20% to 95% Absolute humidity: 36 g/m ³
	1.6 sec (25p/50p mode)	Operating temperature/Humidity	-5 °C to +60 °C (23 °F to +140 °F)/ 20% to 80% Absolute humidity: 36 g/m ³
	Focus Movement time	Power requirements	7 V to 12 V DC
	∞ to Near 1.4 sec	Power consumption	5.5 W (during motor operation: 7.8 W)
Zoom	Enhanced optical zoom 30×	Mass	Approx. 456 g (1 lb. 0.085 oz.)
Digital Zoom	12× (max. 432× with StableZoom)	Dimensions	56 × 64 × 125 mm (2 1/4 × 2 5/8 × 5 in.) (w/h/d)
Angle of view (H)	Approx. 58.1 degrees (Wide end), approx. 2.3 degrees (Tele end)		
Min. working distance	100 mm (Wide end), 1200 mm (Tele end)		
Sync system	Internal		
Min. illumination (Typical value)	In the case of ICR-Off 0.009 lx (1/30 sec, 50%, High Sensitivity mode On) 0.09 lx (1/30 sec, 50%, High Sensitivity mode Off) 0.0012 lx (1/4 sec, 1/3 sec, 50%, High Sensitivity mode On) 0.012 lx (1/4 sec, 1/3 sec, 50%, High Sensitivity mode Off) In the case of ICR-On 0.00008 lx (1/30 sec, 50%, High Sensitivity mode On) 0.00063 lx (1/30 sec, 50%, High Sensitivity mode Off) 0.000005 lx (1/4 sec, 1/3 sec, 30%, High Sensitivity mode On)		
Recommended illumination	100 lx to 100,000 lx		
Image S/N	50 dB (Weight On)		

DIGITAL Image Output Y, Pb, Pr 4:2:2 FORMAT

Color coding complies with BT709.

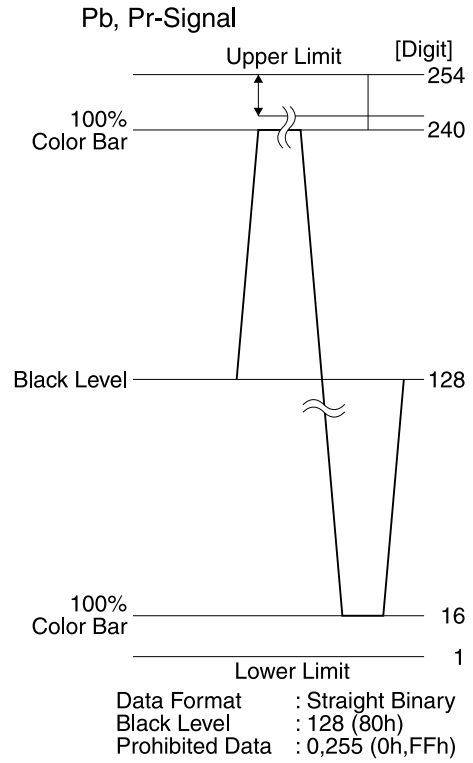
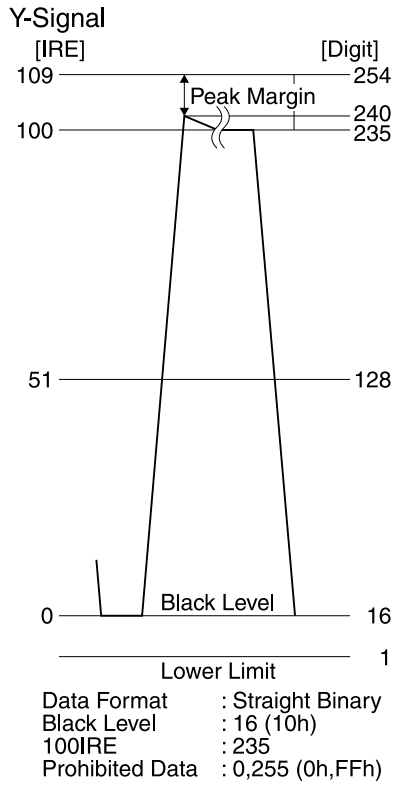

Interface

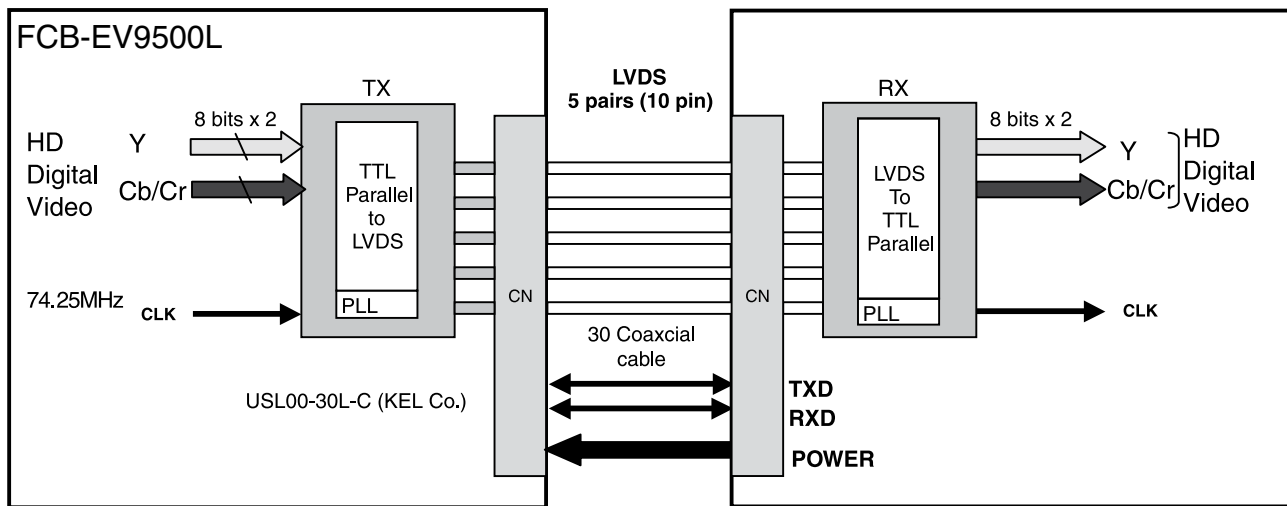

- In FCB-EV9500L, the video signal is transmitted by using LVDS. The LVDS receiver IC chip (e.g., THC63LVD1024, THC63LVD104C, BU90R102) is recommended.
- Recommended connectors and cables
 Cable: #42 Micro coaxial cable
 Connector: USL20-30S (KEL)

LVDS Pixel Data Format

Single Mode

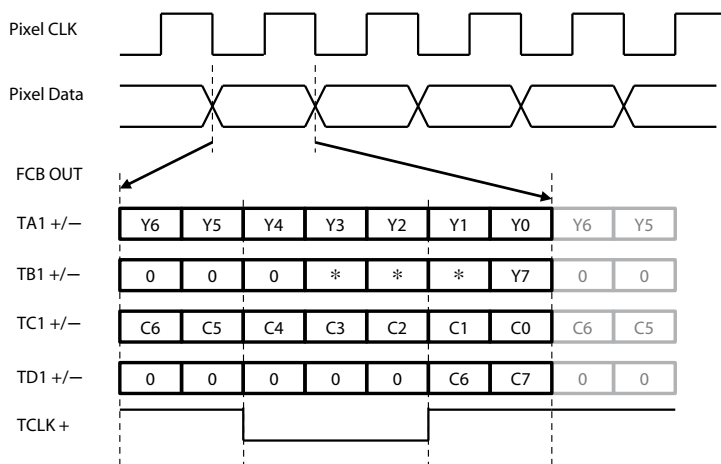

* Please ignore the value which can be "0" or "1".

Output Format	Pixel CLK[Hz]	TCLK+[Hz]
1080p/60	148.5M	148.5M
1080p/59.94	148.5M/1.001	148.5M/1.001
1080p/30	74.25M	74.25M
1080p/29.97	74.25M/1.001	74.25M/1.001
1080i/60	74.25M	74.25M
1080i/59.94	74.25M/1.001	74.25M/1.001
1080i/50	74.25M	74.25M
720p/60	74.25M	74.25M

Output Format	Pixel CLK[Hz]	TCLK+[Hz]
720p/59.94	74.25M/1.001	74.25M/1.001
720p/30	74.25M	74.25M
720p/29.97	74.25M/1.001	74.25M/1.001
1080p/50	148.5M	148.5M
1080p/25	74.25M	74.25M
720p/50	74.25M	74.25M
720p/25	74.25M	74.25M

Double Mode

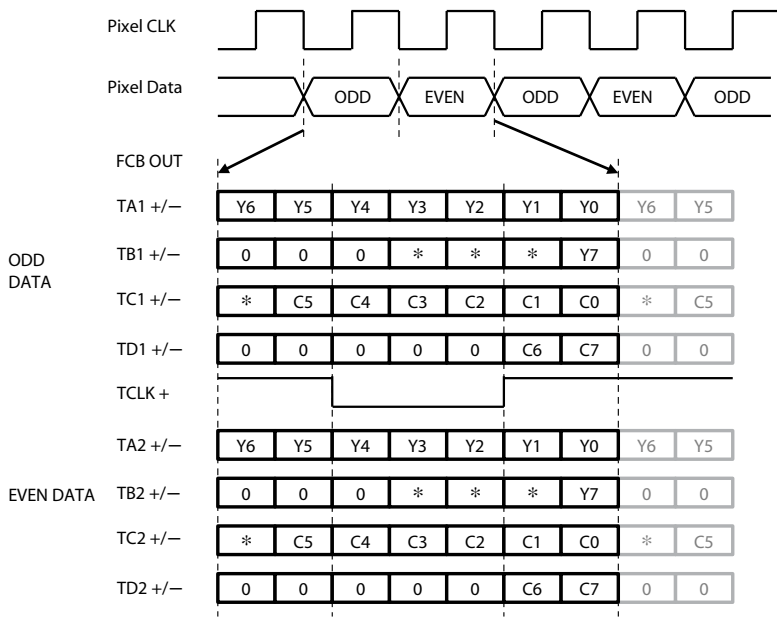

* Please ignore the value which can be "0" or "1".

Output Format	Pixel CLK[Hz]	TCLK+[Hz]
1080p/60	148.5M	74.25M
1080p/59.94	148.5M/1.001	74.25M/1.001
1080p/30	74.25M	37.125M
1080p/29.97	74.25M/1.001	37.125M/1.001
1080i/60	74.25M	37.125M
1080i/59.94	74.25M/1.001	37.125M/1.001
1080i/50	74.25M	37.125M
720p/60	74.25M	37.125M

Output Format	Pixel CLK[Hz]	TCLK+[Hz]
720p/59.94	74.25M/1.001	37.125M/1.001
720p/30	74.25M	37.125M
720p/29.97	74.25M/1.001	37.125M/1.001
1080p/50	148.5M	74.25M
1080p/25	74.25M	37.125M
720p/50	74.25M	37.125M
720p/25	74.25M	37.125M

LVDS receiver circuit example (Single output)

Sony Corporation is not liable for any damages to user's hardware incurred by the use of the circuit example shown below.

LVDS receiver circuit example ① (Single output) * Not compatible with 1080p/60, 59.94, 50

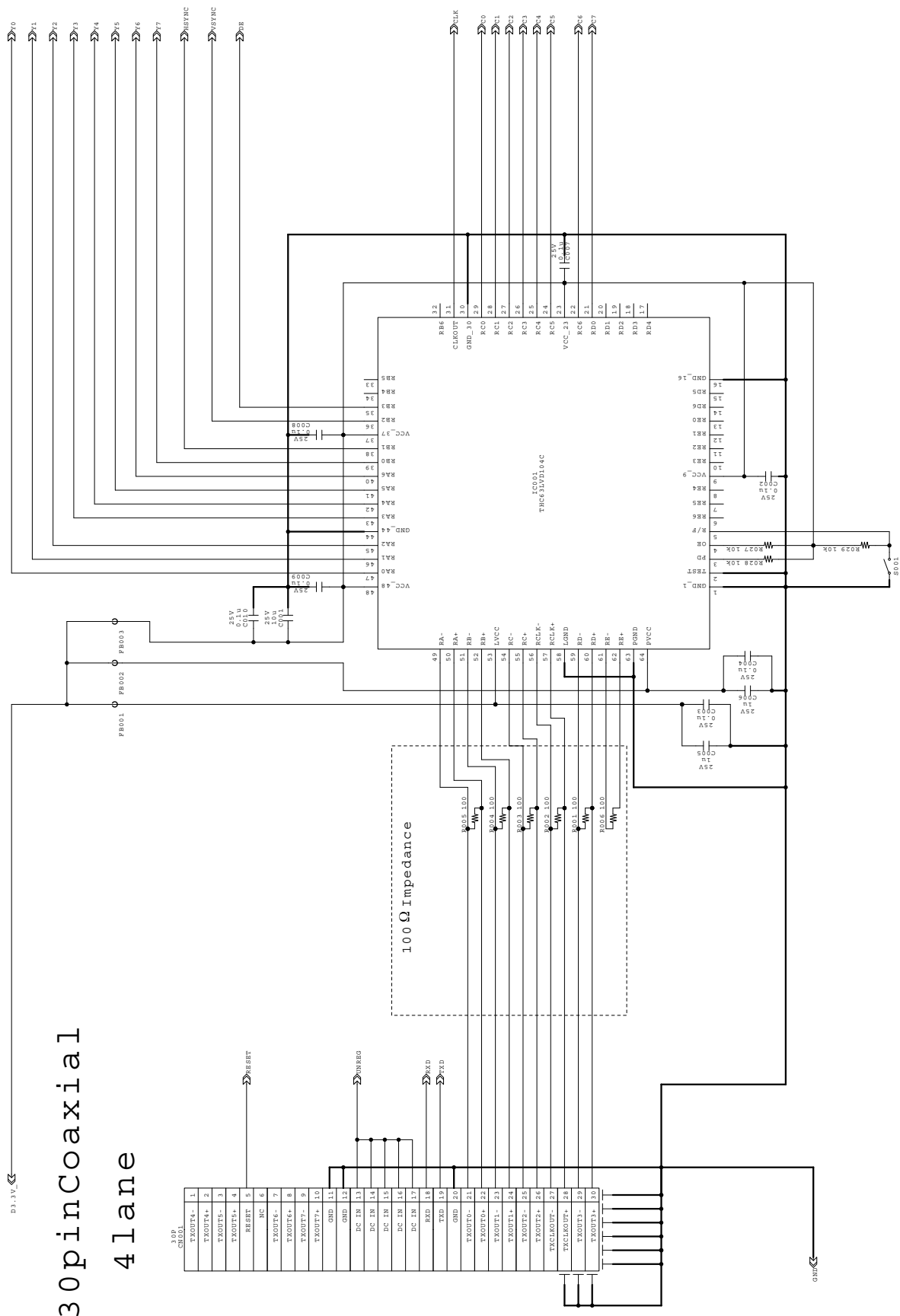

- The switch (S001) selects whether to input the rising edge or falling edge of the signal.

LVDS receiver IC chip (e.g., THC63LVD104C)**Pin assignment Single mode LVDS input - CMOS output * Not compatible with 1080p/60, 59.94, 50**

Pin No.	Description	Signal
1	GND_1	
2	TEST	
3	PD	
4	OE	
5	R/F	
6	RE6	
7	RE5	
8	RE4	
9	VCC_9	
10	RE3	
11	RE2	
12	RE1	
13	RE0	
14	RD6	
15	RD5	
16	GND_16	
17	RD4	
18	RD3	
19	RD2	
20	RD1	
21	RD0	C7
22	RC6	C6
23	VCC_23	
24	RC5	C5
25	RC4	C4
26	RC3	C3
27	RC2	C2
28	RC1	C1
29	RC0	C0
30	GND_30	
31	CLKOUT	CLK
32	RB6	

Pin No.	Description	Signal
33	RB5	
34	RB4	
35	RB3	DE
36	RB2	VSYNC
37	VCC_37	
38	RB1	HSYNC
39	RB0	Y7
40	RA6	Y6
41	RA5	Y5
42	RA4	Y4
43	RA3	Y3
44	GND_44	
45	RA2	Y2
46	RA1	Y1
47	RA0	Y0
48	VCC_48	
49	RA-	TXOUT0-
50	RA+	TXOUT0+
51	RB+	TXOUT1-
52	RB-	TXOUT1+
53	LVCC	
54	RC-	TXOUT2-
55	RC+	TXOUT2+
56	RCLK-	TXCLKOUT-
57	RCLK+	TXCLKOUT+
58	LGND	
59	RD-	TXOUT3-
60	RD+	TXOUT3+
61	RE-	
62	RE+	
63	PGND	
64	PVCC	

LVDS receiver circuit example ② (Single output)

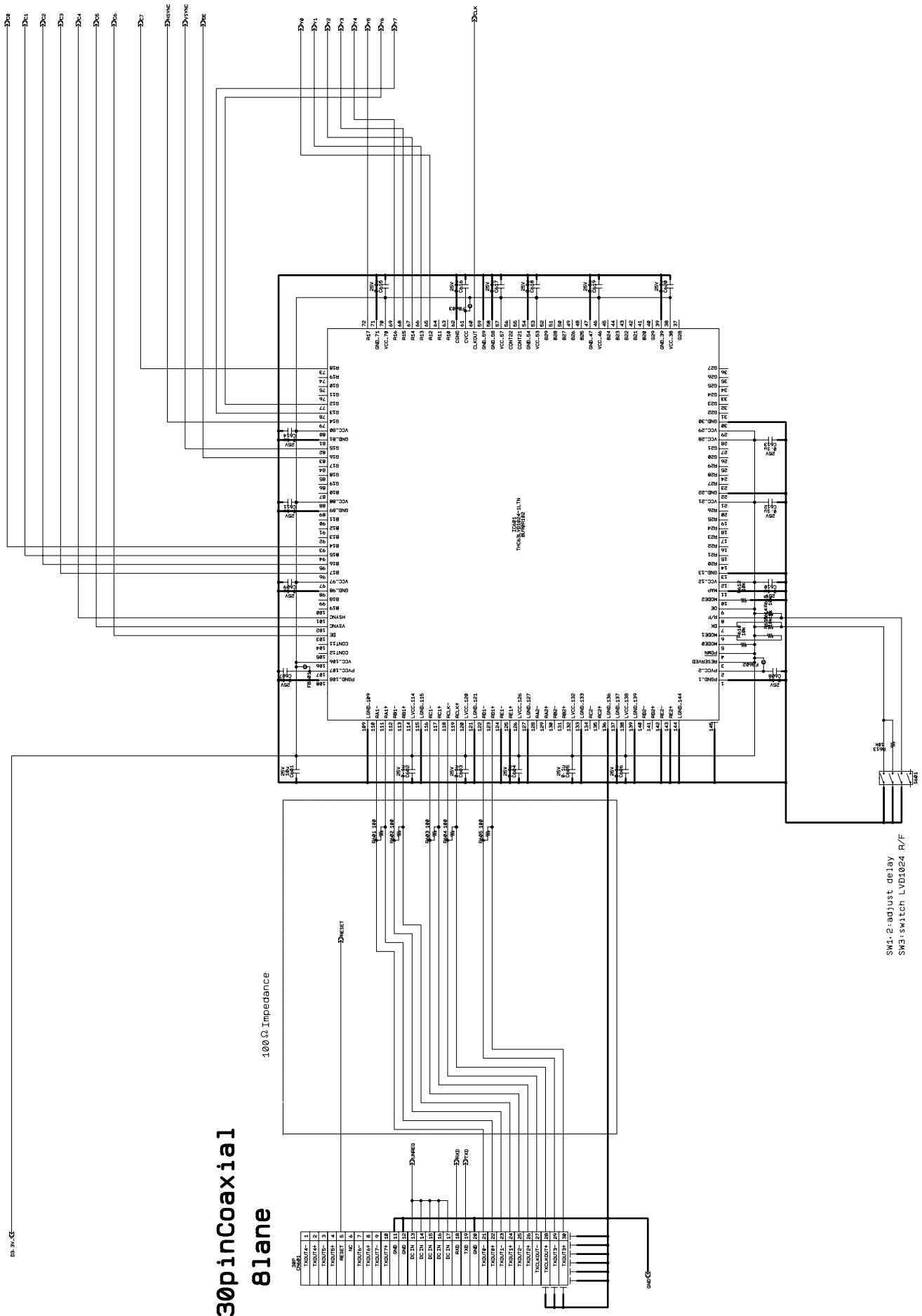

- No.1 and 2 of S601 adjust the signal delay. No.3 selects whether to input the rising edge or falling edge of the signal.

LVDS receiver IC chip (e.g., THC63LVD1024, BU90R102)

Pin assignment Single mode LVDS input - CMOS output

Pin No.	Description	Signal
1	PGND_1	
2	PVCC_2	
3	RESERVED	
4	PDWN	
5	MODE0	
6	MODE1	
7	DK	
8	R/F	
9	OE	
10	MODE2	
11	MAP	
12	VCC_12	
13	GND_13	
14	R20	
15	R21	
16	R22	
17	R23	
18	R24	
19	R25	
20	R26	
21	VCC_21	
22	GND_22	
23	R27	
24	R28	
25	R29	
26	G20	
27	G21	
28	VCC_28	
29	VCC_29	
30	GND_30	
31	G22	
32	G23	
33	G24	
34	G25	
35	G26	
36	G27	
37	G28	
38	VCC_38	
39	GND_39	
40	G29	
41	B20	
42	B21	
43	B22	
44	B23	
45	B24	
46	VCC_46	
47	GND_47	
48	B25	
49	B26	
50	B27	

Pin No.	Description	Signal
51	B28	
52	B29	
53	VCC_53	
54	GND_54	
55	CONT21	
56	CONT22	
57	VCC_57	
58	GND_58	
59	GND_59	
60	CLKOUT	CLK
61	CVCC	
62	CGND	
63	R10	
64	R11	
65	R12	Y0
66	R13	Y1
67	R14	Y2
68	R15	Y3
69	R16	Y4
70	VCC_70	
71	GND_71	
72	R17	Y5
73	R18	C7
74	R19	C6
75	G10	
76	G11	
77	G12	Y6
78	G13	Y7
79	G14	HSYNC
80	VCC_80	
81	GND_81	
82	G15	VSYNC
83	G16	DE
84	G17	
85	G18	
86	G19	
87	B10	
88	VCC_88	
89	GND_89	
90	B11	
91	B12	
92	B13	
93	B14	C0
94	B15	C1
95	B16	C2
96	B17	C3
97	VCC_97	
98	GND_98	
99	B18	
100	B19	

Pin No.	Description	Signal
101	HSYNC	C4
102	VSYNC	C5
103	DE	C6
104	CONT11	
105	CONT12	
106	VCC_106	
107	PVCC_107	
108	PGND_108	
109	LGND_109	
110	RA1-	TXOUT0-
111	RA1+	TXOUT0+
112	RB1-	TXOUT1-
113	RB1+	TXOUT1+
114	LVCC_114	
115	LGND_115	
116	RC1-	TXOUT2-
117	RC1+	TXOUT2+
118	RCLK-	TXCLKOUT-
119	RCLK+	TXCLKOUT+
120	LVCC_120	
121	LGND_121	
122	RD1-	TXOUT3-
123	RD1+	TXOUT3+
124	RE1-	
125	RE1+	
126	LVCC_126	
127	LGND_127	
128	RA2-	
129	RA2+	
130	RB2-	
131	RB2+	
132	LVCC_132	
133	LGND_133	
134	RC2-	
135	RC2+	
136	LGND_136	
137	LGND_137	
138	LVCC_138	
139	LVCC_139	
140	RD2-	
141	RD2+	
142	RE2-	
143	RE2+	
144	LGND_144	

LVDS receiver circuit example ③ (Double output)

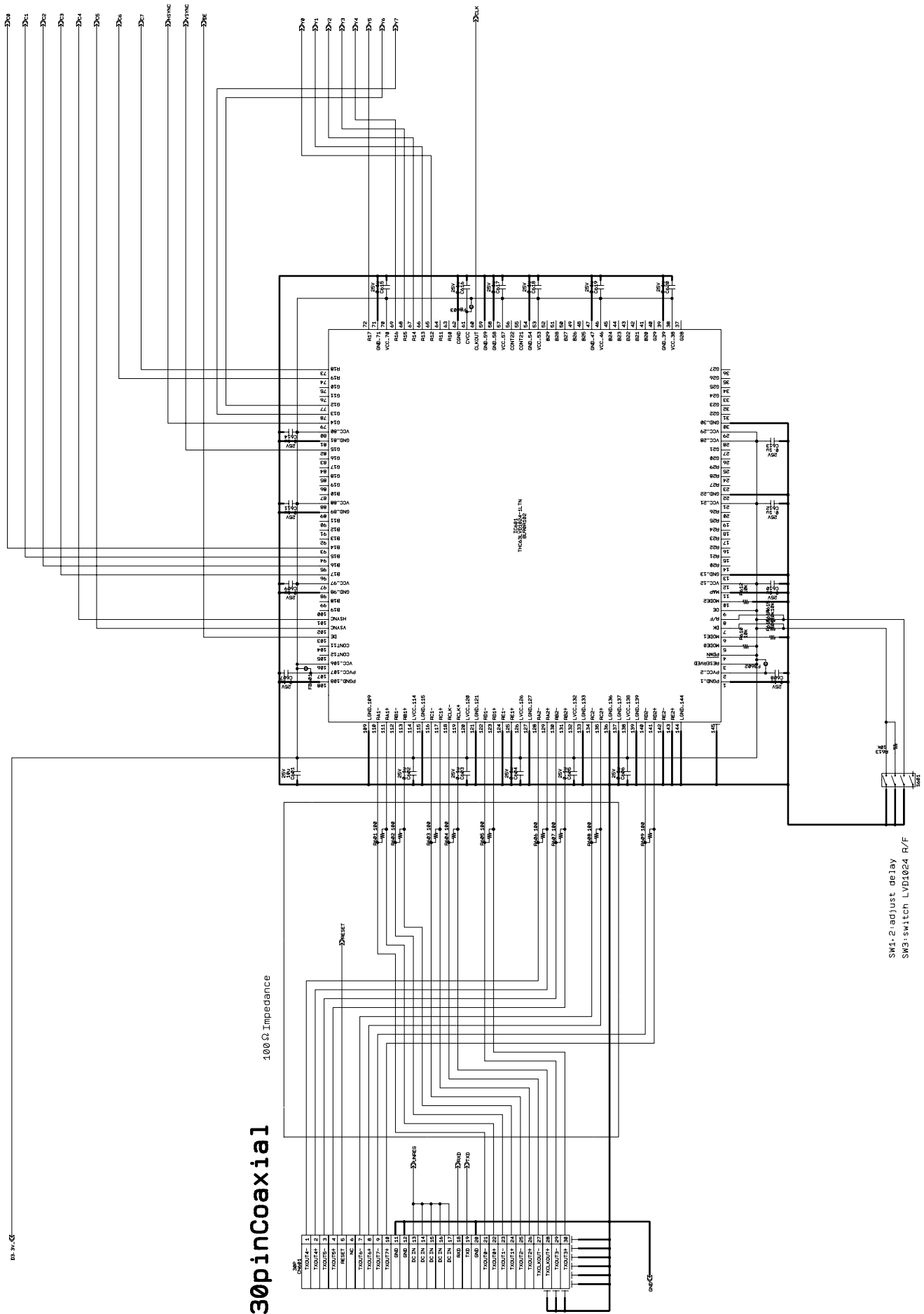

- No.1 and 2 of S601 adjust the signal delay. No.3 selects whether to input the rising edge or falling edge of the signal.

LVDS receiver IC chip (e.g., THC63LVD1024, BU90R102)

Pin assignment Double mode LVDS input - CMOS output

Pin No.	Description	Signal
1	PGND_1	
2	PVCC_2	
3	RESERVED	
4	PDWN	
5	MODE0	
6	MODE1	
7	DK	
8	R/F	
9	OE	
10	MODE2	
11	MAP	
12	VCC_12	
13	GND_13	
14	R20	
15	R21	
16	R22	
17	R23	
18	R24	
19	R25	
20	R26	
21	VCC_21	
22	GND_22	
23	R27	
24	R28	
25	R29	
26	G20	
27	G21	
28	VCC_28	
29	VCC_29	
30	GND_30	
31	G22	
32	G23	
33	G24	
34	G25	
35	G26	
36	G27	
37	G28	
38	VCC_38	
39	GND_39	
40	G29	
41	B20	
42	B21	
43	B22	
44	B23	
45	B24	
46	VCC_46	
47	GND_47	
48	B25	
49	B26	
50	B27	

Pin No.	Description	Signal
51	B28	
52	B29	
53	VCC_53	
54	GND_54	
55	CONT21	
56	CONT22	
57	VCC_57	
58	GND_58	
59	GND_59	
60	CLKOUT	CLK
61	CVCC	
62	CGND	
63	R10	
64	R11	
65	R12	Y0
66	R13	Y1
67	R14	Y2
68	R15	Y3
69	R16	Y4
70	VCC_70	
71	GND_71	
72	R17	Y5
73	R18	C7
74	R19	C6
75	G10	
76	G11	
77	G12	Y6
78	G13	Y7
79	G14	HSYNC
80	VCC_80	
81	GND_81	
82	G15	VSYNC
83	G16	
84	G17	
85	G18	
86	G19	
87	B10	
88	VCC_88	
89	GND_89	
90	B11	
91	B12	
92	B13	
93	B14	C0
94	B15	C1
95	B16	C2
96	B17	C3
97	VCC_97	
98	GND_98	
99	B18	
100	B19	

Pin No.	Description	Signal
101	HSYNC	C4
102	VSYNC	C5
103	DE	DE
104	CONT11	
105	CONT12	
106	VCC_106	
107	PVCC_107	
108	PGND_108	
109	LGND_109	
110	RA1-	TXOUT0-
111	RA1+	TXOUT0+
112	RB1-	TXOUT1-
113	RB1+	TXOUT1+
114	LVCC_114	
115	LGND_115	
116	RC1-	TXOUT2-
117	RC1+	TXOUT2+
118	RCLK-	TXCLKOUT-
119	RCLK+	TXCLKOUT+
120	LVCC_120	
121	LGND_121	
122	RD1-	TXOUT3-
123	RD1+	TXOUT3+
124	RE1-	
125	RE1+	
126	LVCC_126	
127	LGND_127	
128	RA2-	TXOUT4-
129	RA2+	TXOUT4+
130	RB2-	TXOUT5-
131	RB2+	TXOUT5+
132	LVCC_132	
133	LGND_133	
134	RC2-	TXOUT6-
135	RC2+	TXOUT6+
136	LGND_136	
137	LGND_137	
138	LVCC_138	
139	LVCC_139	
140	RD2-	TXOUT7-
141	RD2+	TXOUT7+
142	RE2-	
143	RE2+	
144	LGND_144	

Cable reference specifications (crossover)

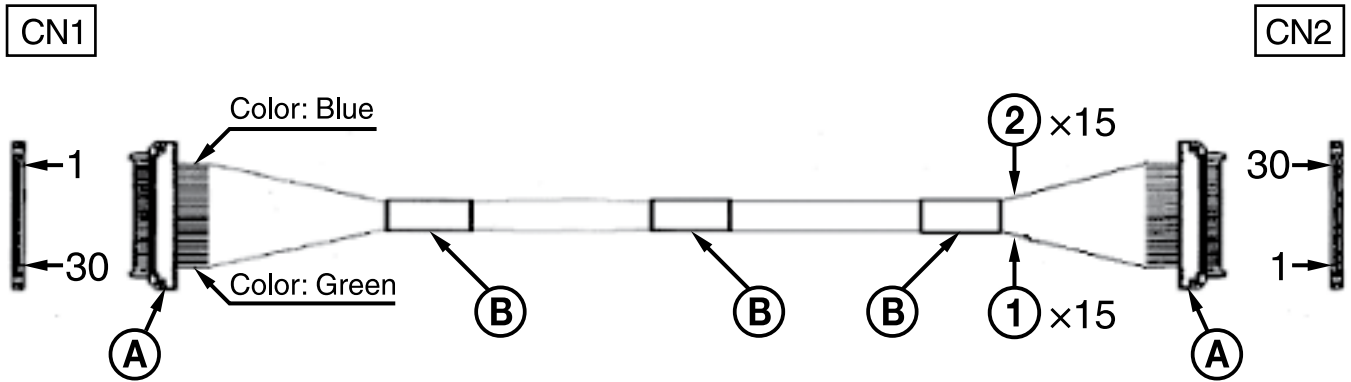

- Recommended connectors and cables
 Cable ① green: #42 Micro coaxial cable
 Cable ② blue: #42 Micro coaxial cable
 Connector ①: USL20-30S (KEL)
 Binding tape ②

Synchronized codes

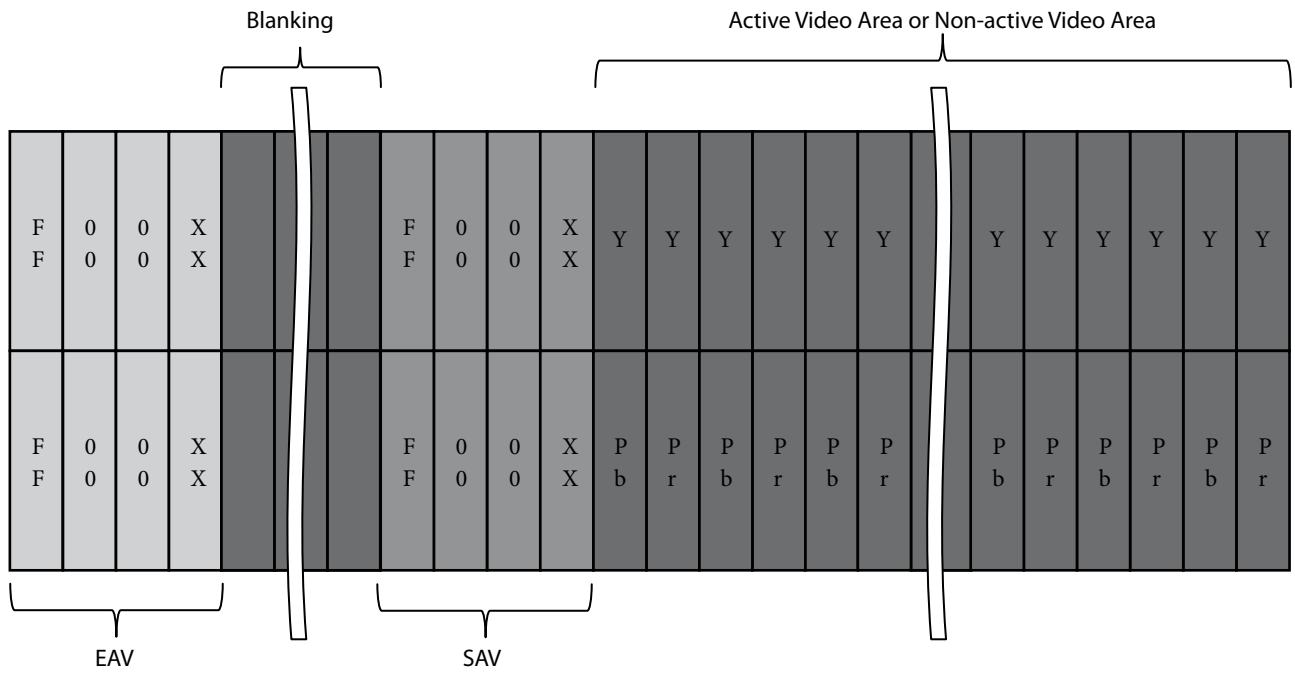

		XX for SAV	XX for EAV
First Field	Active Video Area	80h	9Dh
	Non-active Video Area	ABh	B6h
Second Field	Active Video Area	C7h	DAh
	Non-active Video Area	ECh	F1h

Synchronized codes

Interlace system (Comparable to SMPTE 274 M)

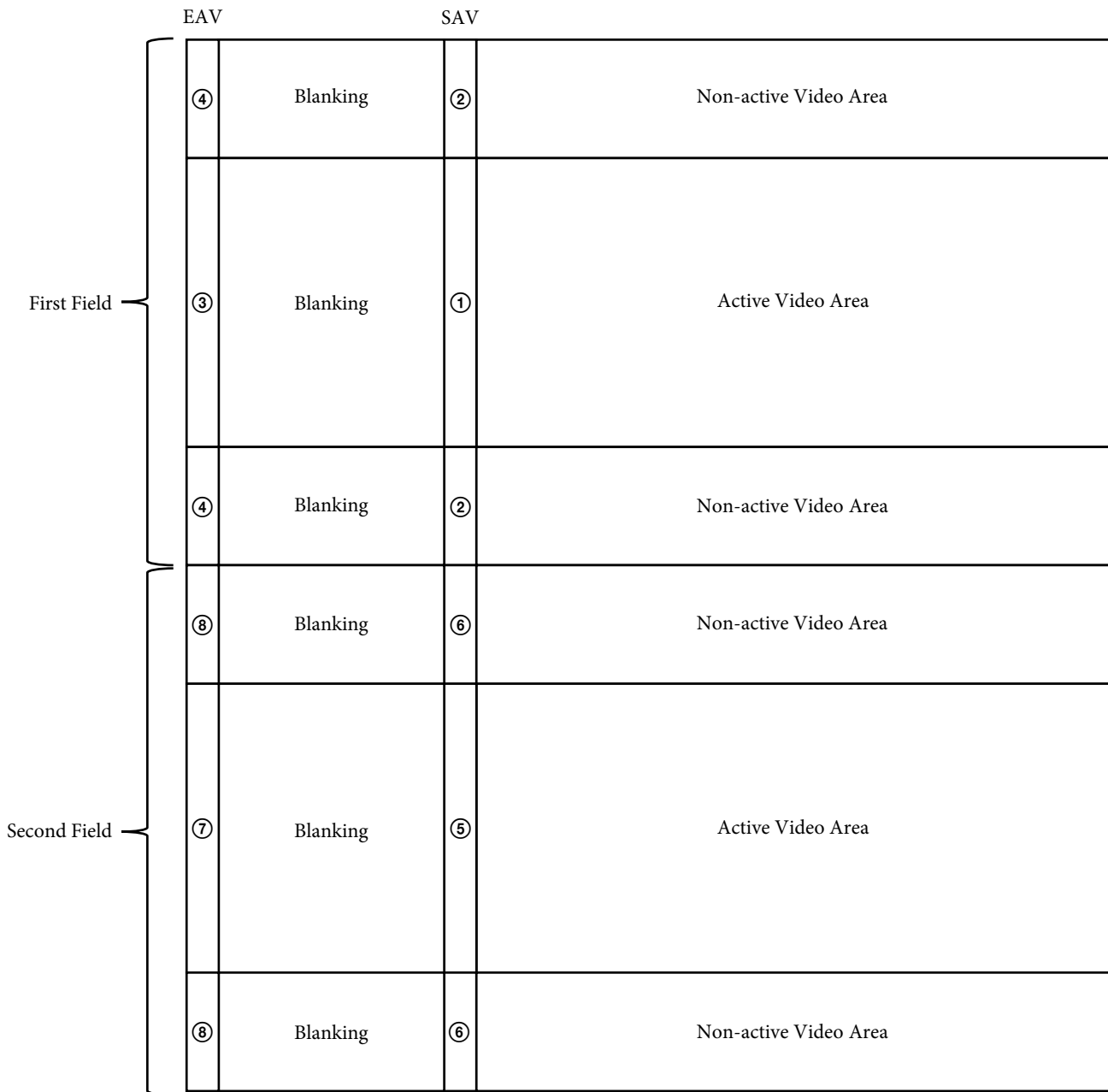

① SAV for First Field Active Video Area

⑤ SAV for Second Field Active Video Area

② SAV for First Field Non-active Video Area

⑥ SAV for Second Field Non-active Video Area

③ EAV for First Field Active Video Area

⑦ EAV for Second Field Active Video Area

④ EAV for First Field Non-active Video Area

⑧ EAV for Second Field Non-active Video Area

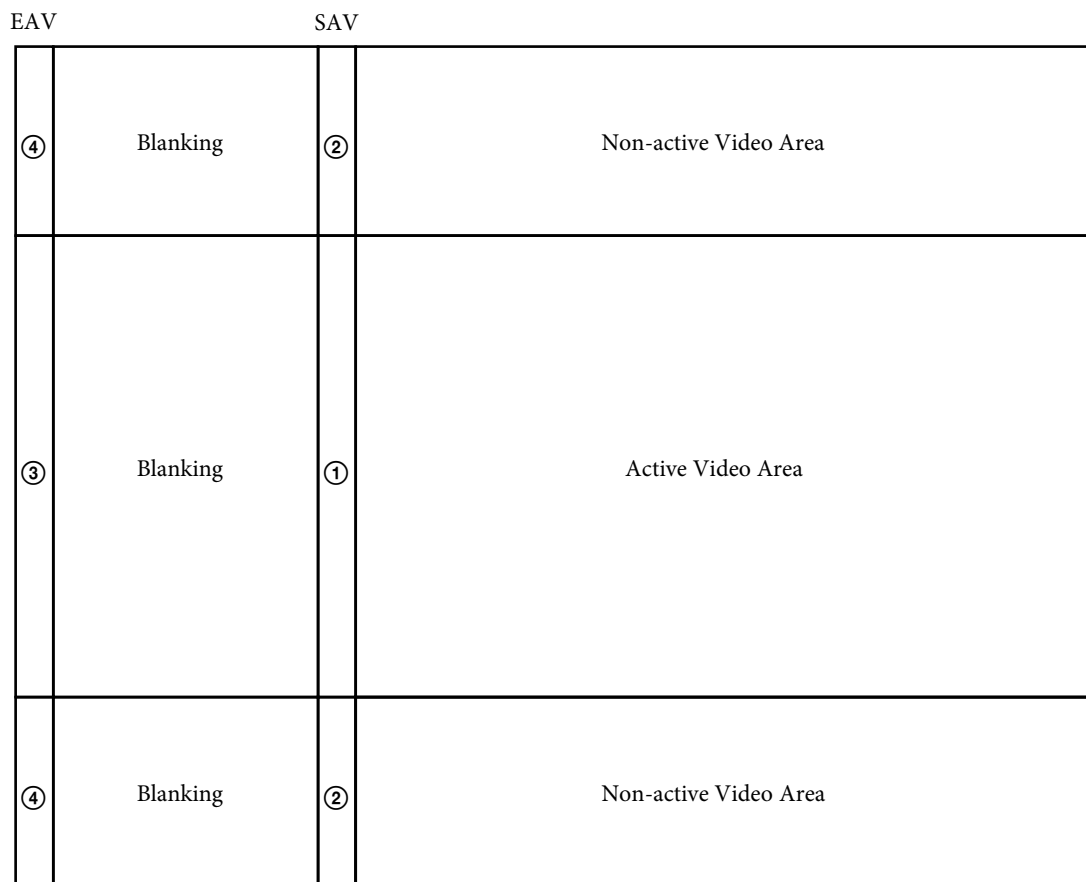
Synchronized codes**Progressive system (Comparable to SMPTE 274 M, 296 M)**

- ① SAV for Active Video Area
- ② SAV for Non-active Video Area
- ③ EAV for Active Video Area
- ④ EAV for Non-active Video Area

Dimensions

Front

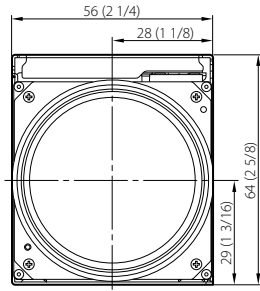

Back

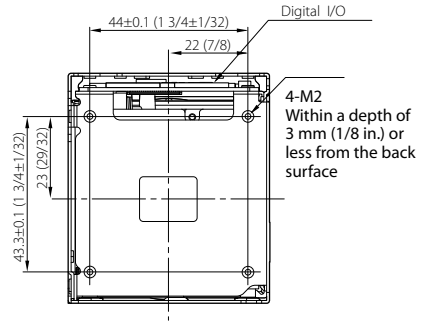

Top

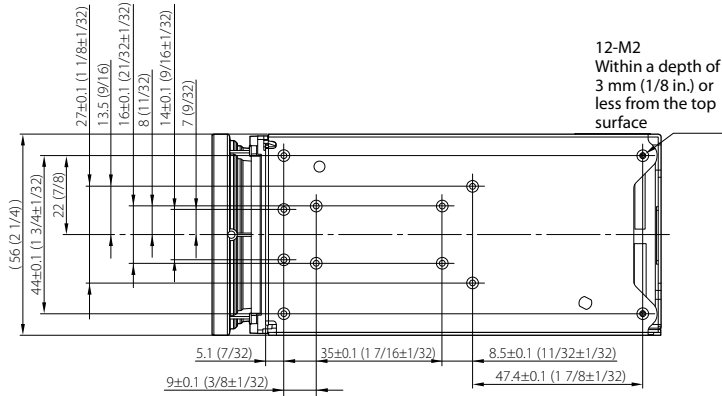

Bottom

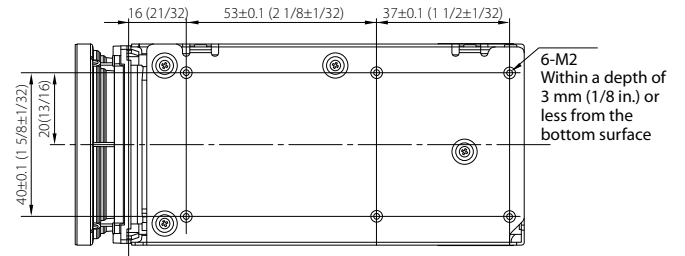

Left side

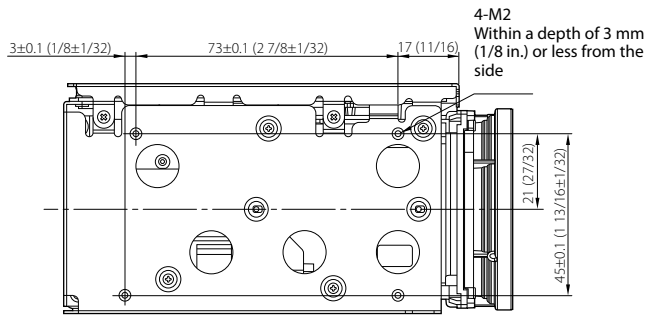

Right side

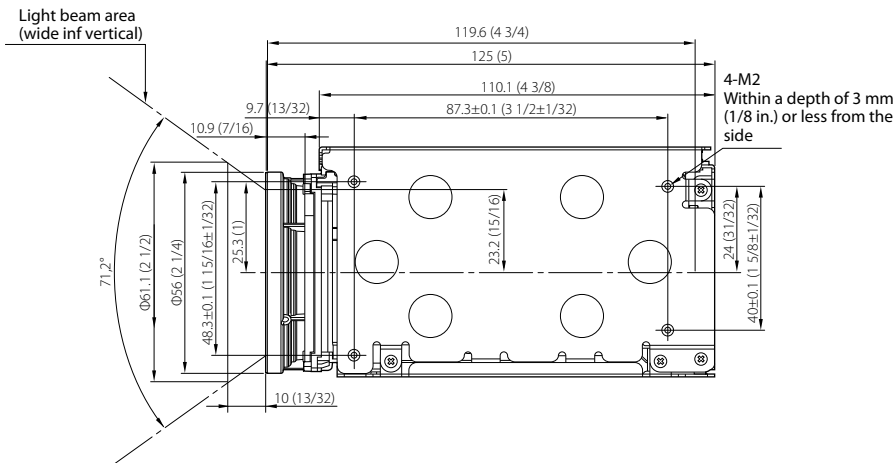

Unit: mm (inches)

Label drawings

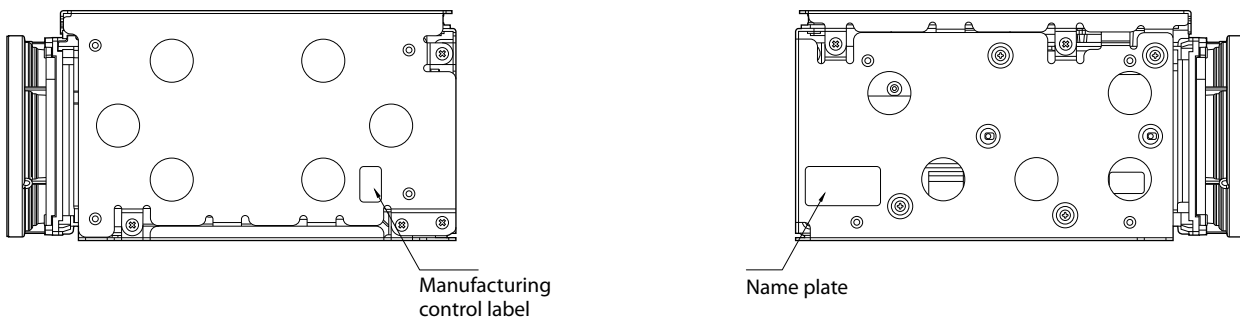

Pin assignment

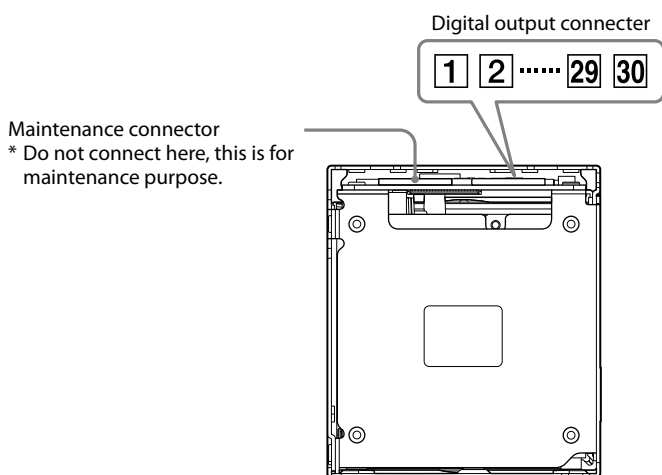

Pin No.	Name	Level
14	DC IN	7 to 12 V DC
15	DC IN	7 to 12 V DC
16	DC IN	7 to 12 V DC
17	DC IN	7 to 12 V DC
18	DC IN	7 to 12 V DC
19	GND	
20	GND	
21	TXOUT7+	Single out mode: open
22	TXOUT7-	Single out mode: open
23	TXOUT6+	Single out mode: open
24	TXOUT6-	Single out mode: open
25	NC	
26	RESET	Reset: Low (GND), Reset release: Open (High Impedance)
27	TXOUT5+	Single out mode: open
28	TXOUT5-	Single out mode: open
29	TXOUT4+	Single out mode: open
30	TXOUT4-	Single out mode: open

Digital output connector

KEL Co. USL00-30L-C

Pin No.	Name	Level
1	TXOUT3+	
2	TXOUT3-	
3	TXCLKOUT+	
4	TXCLKOUT-	
5	TXOUT2+	
6	TXOUT2-	
7	TXOUT1+	
8	TXOUT1-	
9	TXOUT0+	
10	TXOUT0-	
11	GND	
12	TxD	CMOS 3.3 V (Low: Max 0.1 V, High: Min 2.4 V)
13	RxD	CMOS 3.3 V (Low: Max 1.0 V, High: Min 2.3 V), 5.5 V tolerant

Reset Timing Specification

Low level (GND) pulse (whose width is 10 ms or more) resets this camera.

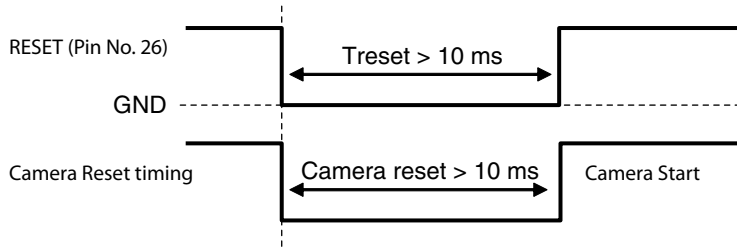

Reset by Visca command

The time required from the end of camera reset to the issue of Network Change is as shown below.

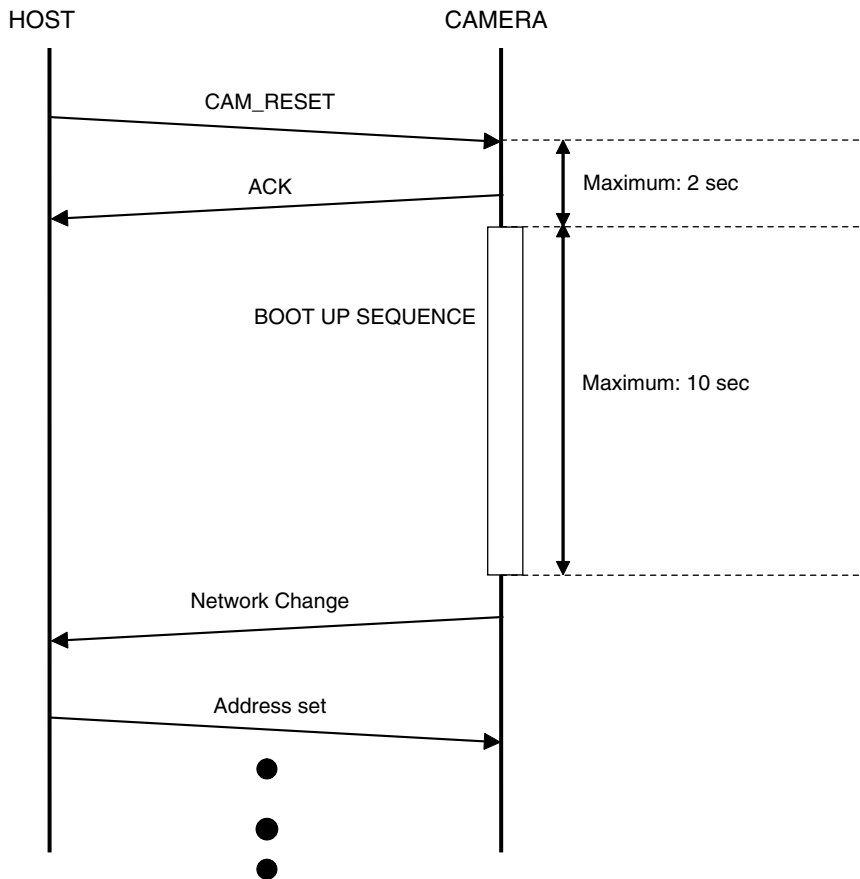

Note on the License

This software uses newlib, and the following license conditions are applied.

The newlib subdirectory is a collection of software from several sources.

Each file may have its own copyright/license that is embedded in the source file. Unless otherwise noted in the body of the source file(s), the following copyright notices will apply to the contents of the newlib subdirectory:

(1) Red Hat Incorporated

Copyright (c) 1994-2009 Red Hat, Inc. All rights reserved.

This copyrighted material is made available to anyone wishing to use, modify, copy, or redistribute it subject to the terms and conditions of the BSD License. This program is distributed in the hope that it will be useful, but WITHOUT ANY WARRANTY expressed or implied, including the implied warranties of MERCHANTABILITY or FITNESS FOR A PARTICULAR PURPOSE. A copy of this license is available at <http://www.opensource.org/licenses>. Any Red Hat trademarks that are incorporated in the source code or documentation are not subject to the BSD License and may only be used or replicated with the express permission of Red Hat, Inc.

(2) University of California, Berkeley

Copyright (c) 1981-2000 The Regents of the University of California.

All rights reserved.

Redistribution and use in source and binary forms, with or without modification, are permitted provided that the following conditions are met:

- * Redistributions of source code must retain the above copyright notice, this list of conditions and the following disclaimer.
- * Redistributions in binary form must reproduce the above copyright notice, this list of conditions and the following disclaimer in the documentation and/or other materials provided with the distribution.
- * Neither the name of the University nor the names of its contributors may be used to endorse or promote products derived from this software without specific prior written permission.

THIS SOFTWARE IS PROVIDED BY THE COPYRIGHT HOLDERS AND CONTRIBUTORS "AS IS"

AND ANY EXPRESS OR IMPLIED WARRANTIES, INCLUDING, BUT NOT LIMITED TO, THE IMPLIED

WARRANTIES OF MERCHANTABILITY AND FITNESS FOR A PARTICULAR PURPOSE ARE DISCLAIMED.

IN NO EVENT SHALL THE COPYRIGHT OWNER OR CONTRIBUTORS BE LIABLE FOR ANY DIRECT,

INDIRECT, INCIDENTAL, SPECIAL, EXEMPLARY, OR CONSEQUENTIAL DAMAGES (INCLUDING, BUT

NOT LIMITED TO, PROCUREMENT OF SUBSTITUTE GOODS OR SERVICES; LOSS OF USE, DATA, OR

PROFITS; OR BUSINESS INTERRUPTION) HOWEVER CAUSED AND ON ANY THEORY OF LIABILITY,

WHETHER IN CONTRACT, STRICT LIABILITY, OR TORT (INCLUDING NEGLIGENCE OR OTHERWISE)

ARISING IN ANY WAY OUT OF THE USE OF THIS SOFTWARE, EVEN IF ADVISED OF THE POSSIBILITY OF SUCH DAMAGE.

(3) David M. Gay (AT&T 1991, Lucent 1998)

The author of this software is David M. Gay.

Copyright (c) 1991 by AT&T.

Permission to use, copy, modify, and distribute this software for any purpose without fee is hereby granted, provided that this entire notice is included in all copies of any software which is or includes a copy or modification of this software and in all copies of the supporting documentation for such software.

THIS SOFTWARE IS BEING PROVIDED "AS IS", WITHOUT ANY EXPRESS OR IMPLIED

WARRANTY. IN PARTICULAR, NEITHER THE AUTHOR NOR AT&T MAKES ANY

REPRESENTATION OR WARRANTY OF ANY KIND CONCERNING THE MERCHANTABILITY

OF THIS SOFTWARE OR ITS FITNESS FOR ANY PARTICULAR PURPOSE.

The author of this software is David M. Gay.

Copyright (C) 1998-2001 by Lucent Technologies

All Rights Reserved

Permission to use, copy, modify, and distribute this software and its documentation for any purpose and without fee is hereby granted, provided that the above copyright notice appear in all copies and that both that the copyright notice and this permission notice and warranty disclaimer appear in supporting documentation, and that the name of Lucent or any of its entities not be used in advertising or publicity pertaining to distribution of the software without specific, written prior permission.

LUCENT DISCLAIMS ALL WARRANTIES WITH REGARD TO THIS SOFTWARE,

INCLUDING ALL IMPLIED WARRANTIES OF MERCHANTABILITY AND FITNESS.

IN NO EVENT SHALL LUCENT OR ANY OF ITS ENTITIES BE LIABLE FOR ANY

SPECIAL, INDIRECT OR CONSEQUENTIAL DAMAGES OR ANY DAMAGES

WHATSOEVER RESULTING FROM LOSS OF USE, DATA OR PROFITS, WHETHER

IN AN ACTION OF CONTRACT, NEGLIGENCE OR OTHER TORTIOUS ACTION,

ARISING OUT OF OR IN CONNECTION WITH THE USE OR PERFORMANCE OF

THIS SOFTWARE.

(4) Advanced Micro Devices

Copyright 1989, 1990 Advanced Micro Devices, Inc.

This software is the property of Advanced Micro Devices, Inc (AMD) which specifically grants the user the right to modify, use and distribute this software provided this notice is not removed or altered. All other rights are reserved by AMD.

AMD MAKES NO WARRANTY OF ANY KIND, EXPRESS OR IMPLIED, WITH REGARD TO THIS

SOFTWARE. IN NO EVENT SHALL AMD BE LIABLE FOR INCIDENTAL OR CONSEQUENTIAL

DAMAGES IN CONNECTION WITH OR ARISING FROM THE FURNISHING, PERFORMANCE, OR

USE OF THIS SOFTWARE.

So that all may benefit from your experience, please report any problems or suggestions about this software to the 29K Technical Support Center at 800-29-29-AMD (800-292-9263) in the USA, or 0800-89-1131 in the UK, or 0031-11-1129 in Japan, toll free. The direct dial number is 512-462-4118.

Advanced Micro Devices, Inc.

29K Support Products

Mail Stop 573

5900 E. Ben White Blvd.

Austin, TX 78741

800-292-9263

(7) Sun Microsystems

Copyright (C) 1993 by Sun Microsystems, Inc. All rights reserved.

Developed at SunPro, a Sun Microsystems, Inc. business.

Permission to use, copy, modify, and distribute this software is freely granted, provided that this notice is preserved.

(8) Hewlett Packard

(c) Copyright 1986 HEWLETT-PACKARD COMPANY

To anyone who acknowledges that this file is provided "AS IS" without any express or implied warranty:

permission to use, copy, modify, and distribute this file for any purpose is hereby granted without fee, provided that the above copyright notice and this notice appears in all copies, and that the name of Hewlett-Packard Company not be used in advertising or publicity pertaining to distribution of the software without specific, written prior permission.

Hewlett-Packard Company makes no representations about the suitability of this software for any purpose.

(9) Hans-Peter Nilsson

Copyright (C) 2001 Hans-Peter Nilsson

Permission to use, copy, modify, and distribute this software is freely granted, provided that the above copyright notice, this notice and the following disclaimer are preserved with no changes.

THIS SOFTWARE IS PROVIDED "AS IS" AND WITHOUT ANY EXPRESS OR

IMPLIED WARRANTIES, INCLUDING, WITHOUT LIMITATION, THE IMPLIED

WARRANTIES OF MERCHANTABILITY AND FITNESS FOR A PARTICULAR

PURPOSE.

(10)Stephane Carrez (m68hc11-elf/m68hc12-elf targets only)

Copyright (C) 1999, 2000, 2001, 2002 Stephane Carrez (stcarrez@nerim.fr)

The authors hereby grant permission to use, copy, modify, distribute, and license this software and its documentation for any purpose, provided that existing copyright notices are retained in all copies and that this notice is included verbatim in any distributions. No written agreement, license, or royalty fee is required for any of the authorized uses.

Modifications to this software may be copyrighted by their authors and need not follow the licensing terms described here, provided that the new terms are clearly indicated on the first page of each file where they apply.

(11)Christopher G. Demetriou

Copyright (c) 2001 Christopher G. Demetriou

All rights reserved.

Redistribution and use in source and binary forms, with or without modification, are permitted provided that the following conditions are met:

1. Redistributions of source code must retain the above copyright notice, this list of conditions and the following disclaimer.
2. Redistributions in binary form must reproduce the above copyright notice, this list of conditions and the following disclaimer in the documentation and/or other materials provided with the distribution.
3. The name of the author may not be used to endorse or promote products derived from this software without specific prior written permission.

THIS SOFTWARE IS PROVIDED BY THE AUTHOR "AS IS" AND ANY EXPRESS OR

IMPLIED WARRANTIES, INCLUDING, BUT NOT LIMITED TO, THE IMPLIED WARRANTIES

OF MERCHANTABILITY AND FITNESS FOR A PARTICULAR PURPOSE ARE DISCLAIMED.

IN NO EVENT SHALL THE AUTHOR BE LIABLE FOR ANY DIRECT, INDIRECT,

INCIDENTAL, SPECIAL, EXEMPLARY, OR CONSEQUENTIAL DAMAGES (INCLUDING, BUT

NOT LIMITED TO, PROCUREMENT OF SUBSTITUTE GOODS OR SERVICES; LOSS OF USE,

DATA, OR PROFITS; OR BUSINESS INTERRUPTION) HOWEVER CAUSED AND ON ANY

THEORY OF LIABILITY, WHETHER IN CONTRACT, STRICT LIABILITY, OR TORT

(INCLUDING NEGLIGENCE OR OTHERWISE) ARISING IN ANY WAY OUT OF THE USE OF

THIS SOFTWARE, EVEN IF ADVISED OF THE POSSIBILITY OF SUCH DAMAGE.

(12)SuperH, Inc.

Copyright 2002 SuperH, Inc. All rights reserved

This software is the property of SuperH, Inc (SuperH) which specifically grants the user the right to modify, use and distribute this software provided this notice is not removed or altered. All other rights are reserved by SuperH.

SUPERH MAKES NO WARRANTY OF ANY KIND, EXPRESS OR IMPLIED, WITH REGARD TO

THIS SOFTWARE. IN NO EVENT SHALL SUPERH BE LIABLE FOR INDIRECT, SPECIAL,

INCIDENTAL OR CONSEQUENTIAL DAMAGES IN CONNECTION WITH OR ARISING FROM

THE FURNISHING, PERFORMANCE, OR USE OF THIS SOFTWARE.

So that all may benefit from your experience, please report any problems or suggestions about this software to the SuperH Support Center via e-mail at softwaresupport@superh.com.

SuperH, Inc.

405 River Oaks Parkway

San Jose

CA 95134

USA

(13) Royal Institute of Technology

Copyright (c) 1999 Kungliga Tekniska Högskolan

(Royal Institute of Technology, Stockholm, Sweden).

All rights reserved.

Redistribution and use in source and binary forms, with or without modification, are permitted provided that the following conditions are met:

1. Redistributions of source code must retain the above copyright notice, this list of conditions and the following disclaimer.
2. Redistributions in binary form must reproduce the above copyright notice, this list of conditions and the following disclaimer in the documentation and/or other materials provided with the distribution.
3. Neither the name of KTH nor the names of its contributors may be used to endorse or promote products derived from this software without specific prior written permission.

THIS SOFTWARE IS PROVIDED BY KTH AND ITS CONTRIBUTORS ``AS IS'' AND ANY

EXPRESS OR IMPLIED WARRANTIES, INCLUDING, BUT NOT LIMITED TO, THE

IMPLIED WARRANTIES OF MERCHANTABILITY AND FITNESS FOR A PARTICULAR

PURPOSE ARE DISCLAIMED. IN NO EVENT SHALL KTH OR ITS CONTRIBUTORS BE

LIABLE FOR ANY DIRECT, INDIRECT, INCIDENTAL, SPECIAL, EXEMPLARY, OR

CONSEQUENTIAL DAMAGES (INCLUDING, BUT NOT LIMITED TO, PROCUREMENT OF

SUBSTITUTE GOODS OR SERVICES; LOSS OF USE, DATA, OR PROFITS; OR

BUSINESS INTERRUPTION) HOWEVER CAUSED AND ON ANY THEORY OF LIABILITY,

WHETHER IN CONTRACT, STRICT LIABILITY, OR TORT (INCLUDING NEGLIGENCE OR

OTHERWISE) ARISING IN ANY WAY OUT OF THE USE OF THIS SOFTWARE, EVEN IF

ADVISED OF THE POSSIBILITY OF SUCH DAMAGE.

(14) Alexey Zelkin

Copyright (c) 2000, 2001 Alexey Zelkin <phantom@FreeBSD.org>

All rights reserved.

Redistribution and use in source and binary forms, with or

without modification, are permitted provided that the following conditions are met:

1. Redistributions of source code must retain the above copyright notice, this list of conditions and the following disclaimer.
2. Redistributions in binary form must reproduce the above copyright notice, this list of conditions and the following disclaimer in the documentation and/or other materials provided with the distribution.

THIS SOFTWARE IS PROVIDED BY THE AUTHOR AND CONTRIBUTORS ``AS IS'' AND

ANY EXPRESS OR IMPLIED WARRANTIES, INCLUDING, BUT NOT LIMITED TO, THE

IMPLIED WARRANTIES OF MERCHANTABILITY AND FITNESS FOR A PARTICULAR PURPOSE

ARE DISCLAIMED. IN NO EVENT SHALL THE AUTHOR OR CONTRIBUTORS BE LIABLE

FOR ANY DIRECT, INDIRECT, INCIDENTAL, SPECIAL, EXEMPLARY, OR CONSEQUENTIAL

DAMAGES (INCLUDING, BUT NOT LIMITED TO, PROCUREMENT OF SUBSTITUTE GOODS

OR SERVICES; LOSS OF USE, DATA, OR PROFITS; OR BUSINESS INTERRUPTION)

HOWEVER CAUSED AND ON ANY THEORY OF LIABILITY, WHETHER IN CONTRACT, STRICT

LIABILITY, OR TORT (INCLUDING NEGLIGENCE OR OTHERWISE) ARISING IN ANY WAY

OUT OF THE USE OF THIS SOFTWARE, EVEN IF ADVISED OF THE POSSIBILITY OF

SUCH DAMAGE.

(15) Andrey A. Chernov

Copyright (C) 1997 by Andrey A. Chernov, Moscow, Russia.

All rights reserved.

Redistribution and use in source and binary forms, with or without modification, are permitted provided that the following conditions are met:

1. Redistributions of source code must retain the above copyright notice, this list of conditions and the following disclaimer.
2. Redistributions in binary form must reproduce the above copyright notice, this list of conditions and the following disclaimer in the documentation and/or other materials provided with the distribution.

THIS SOFTWARE IS PROVIDED BY THE AUTHOR ``AS IS'' AND

ANY EXPRESS OR IMPLIED WARRANTIES, INCLUDING, BUT NOT LIMITED TO, THE

IMPLIED WARRANTIES OF MERCHANTABILITY AND FITNESS FOR A PARTICULAR PURPOSE

ARE DISCLAIMED. IN NO EVENT SHALL THE REGENTS OR CONTRIBUTORS BE LIABLE

FOR ANY DIRECT, INDIRECT, INCIDENTAL, SPECIAL, EXEMPLARY, OR CONSEQUENTIAL

DAMAGES (INCLUDING, BUT NOT LIMITED TO, PROCUREMENT OF SUBSTITUTE GOODS

OR SERVICES; LOSS OF USE, DATA, OR PROFITS; OR BUSINESS INTERRUPTION)

HOWEVER CAUSED AND ON ANY THEORY OF LIABILITY, WHETHER IN CONTRACT, STRICT

LIABILITY, OR TORT (INCLUDING NEGLIGENCE OR OTHERWISE) ARISING IN ANY WAY OUT OF THE USE OF THIS SOFTWARE, EVEN IF ADVISED OF THE POSSIBILITY OF SUCH DAMAGE.

(16) FreeBSD

Copyright (c) 1997-2002 FreeBSD Project.

All rights reserved.

Redistribution and use in source and binary forms, with or without modification, are permitted provided that the following conditions are met:

1. Redistributions of source code must retain the above copyright notice, this list of conditions and the following disclaimer.
2. Redistributions in binary form must reproduce the above copyright notice, this list of conditions and the following disclaimer in the documentation and/or other materials provided with the distribution.

THIS SOFTWARE IS PROVIDED BY THE AUTHOR AND CONTRIBUTORS ``AS IS'' AND

ANY EXPRESS OR IMPLIED WARRANTIES, INCLUDING, BUT NOT LIMITED TO, THE

IMPLIED WARRANTIES OF MERCHANTABILITY AND FITNESS FOR A PARTICULAR PURPOSE

ARE DISCLAIMED. IN NO EVENT SHALL THE AUTHOR OR CONTRIBUTORS BE LIABLE

FOR ANY DIRECT, INDIRECT, INCIDENTAL, SPECIAL, EXEMPLARY, OR CONSEQUENTIAL

DAMAGES (INCLUDING, BUT NOT LIMITED TO, PROCUREMENT OF SUBSTITUTE GOODS

OR SERVICES; LOSS OF USE, DATA, OR PROFITS; OR BUSINESS INTERRUPTION)

HOWEVER CAUSED AND ON ANY THEORY OF LIABILITY, WHETHER IN CONTRACT, STRICT

LIABILITY, OR TORT (INCLUDING NEGLIGENCE OR OTHERWISE) ARISING IN ANY WAY

OUT OF THE USE OF THIS SOFTWARE, EVEN IF ADVISED OF THE POSSIBILITY OF

SUCH DAMAGE.

(17) S. L. Moshier

Author: S. L. Moshier.

Copyright (c) 1984,2000 S.L. Moshier

Permission to use, copy, modify, and distribute this software for any purpose without fee is hereby granted, provided that this entire notice is included in all copies of any software which is or includes a copy or modification of this software and in all copies of the supporting documentation for such software.

THIS SOFTWARE IS BEING PROVIDED "AS IS", WITHOUT ANY EXPRESS OR IMPLIED

WARRANTY. IN PARTICULAR, THE AUTHOR MAKES NO REPRESENTATION

OR WARRANTY OF ANY KIND CONCERNING THE MERCHANTABILITY OF THIS

SOFTWARE OR ITS FITNESS FOR ANY PARTICULAR PURPOSE.

(18) Citrus Project

Copyright (c)1999 Citrus Project,

All rights reserved.

Redistribution and use in source and binary forms, with or without modification, are permitted provided that the following conditions are met:

1. Redistributions of source code must retain the above copyright notice, this list of conditions and the following disclaimer.
2. Redistributions in binary form must reproduce the above copyright notice, this list of conditions and the following disclaimer in the documentation and/or other materials provided with the distribution.

THIS SOFTWARE IS PROVIDED BY THE AUTHOR AND CONTRIBUTORS ``AS IS'' AND

ANY EXPRESS OR IMPLIED WARRANTIES, INCLUDING, BUT NOT LIMITED TO, THE

IMPLIED WARRANTIES OF MERCHANTABILITY AND FITNESS FOR A PARTICULAR PURPOSE

ARE DISCLAIMED. IN NO EVENT SHALL THE AUTHOR OR CONTRIBUTORS BE LIABLE

FOR ANY DIRECT, INDIRECT, INCIDENTAL, SPECIAL, EXEMPLARY, OR CONSEQUENTIAL

DAMAGES (INCLUDING, BUT NOT LIMITED TO, PROCUREMENT OF SUBSTITUTE GOODS

OR SERVICES; LOSS OF USE, DATA, OR PROFITS; OR BUSINESS INTERRUPTION)

HOWEVER CAUSED AND ON ANY THEORY OF LIABILITY, WHETHER IN CONTRACT, STRICT

LIABILITY, OR TORT (INCLUDING NEGLIGENCE OR OTHERWISE) ARISING IN ANY WAY

OUT OF THE USE OF THIS SOFTWARE, EVEN IF ADVISED OF THE POSSIBILITY OF

SUCH DAMAGE.

(19) Todd C. Miller

Copyright (c) 1998 Todd C. Miller <Todd.Miller@courtesan.com>

All rights reserved.

Redistribution and use in source and binary forms, with or without

modification, are permitted provided that the following conditions are met:

1. Redistributions of source code must retain the above copyright notice, this list of conditions and the following disclaimer.
2. Redistributions in binary form must reproduce the above copyright notice, this list of conditions and the following disclaimer in the documentation and/or other materials provided with the distribution.
3. The name of the author may not be used to endorse or promote products derived from this software without specific prior written permission.

THIS SOFTWARE IS PROVIDED ``AS IS'' AND ANY EXPRESS OR IMPLIED WARRANTIES,

INCLUDING, BUT NOT LIMITED TO, THE IMPLIED WARRANTIES OF MERCHANTABILITY

AND FITNESS FOR A PARTICULAR PURPOSE ARE DISCLAIMED. IN NO EVENT SHALL

THE AUTHOR BE LIABLE FOR ANY DIRECT, INDIRECT, INCIDENTAL, SPECIAL,

EXEMPLARY, OR CONSEQUENTIAL DAMAGES (INCLUDING, BUT NOT LIMITED TO,

PROCUREMENT OF SUBSTITUTE GOODS OR SERVICES;
LOSS OF USE, DATA, OR PROFITS;

OR BUSINESS INTERRUPTION) HOWEVER CAUSED AND
ON ANY THEORY OF LIABILITY,

WHETHER IN CONTRACT, STRICT LIABILITY, OR TORT
(INCLUDING NEGLIGENCE OR

OTHERWISE) ARISING IN ANY WAY OUT OF THE USE OF
THIS SOFTWARE, EVEN IF

ADVISED OF THE POSSIBILITY OF SUCH DAMAGE.

(20) DJ Delorie (i386)

Copyright (C) 1991 DJ Delorie

All rights reserved.

Redistribution, modification, and use in source and binary forms
is permitted provided that the above copyright notice and
following paragraph are duplicated in all such forms.

This file is distributed WITHOUT ANY WARRANTY; without even
the implied warranty of MERCHANTABILITY or FITNESS FOR A
PARTICULAR PURPOSE.

(21) Free Software Foundation LGPL License (*-linux* targets only)

Copyright (C) 1990-1999, 2000, 2001 Free Software Foundation,
Inc.

This file is part of the GNU C Library.

Contributed by Mark Kettenis <kettenis@phys.uva.nl>, 1997.

The GNU C Library is free software; you can redistribute it and/
or modify it under the terms of the GNU Lesser General Public
License as published by the Free Software Foundation; either
version 2.1 of the License, or (at your option) any later version.

The GNU C Library is distributed in the hope that it will be useful,
but WITHOUT ANY WARRANTY; without even the implied
warranty of MERCHANTABILITY or FITNESS FOR A
PARTICULAR PURPOSE. See the GNU Lesser General Public
License for more details.

You should have received a copy of the GNU Lesser General
Public

License along with the GNU C Library; if not, write to the Free
Software Foundation, Inc., 51 Franklin Street, Fifth Floor, Boston,
MA

02110-1301 USA.

(22) Xavier Leroy LGPL License ([f3456]86-*-linux* targets only)

Copyright (C) 1996 Xavier Leroy (Xavier.Leroy@inria.fr)

This program is free software; you can redistribute it and/or
modify it under the terms of the GNU Library General Public
License as published by the Free Software Foundation; either
version 2 of the License, or (at your option) any later version.

This program is distributed in the hope that it will be useful, but
WITHOUT ANY WARRANTY; without even the implied warranty
of MERCHANTABILITY or FITNESS FOR A PARTICULAR
PURPOSE. See the GNU Library General Public License for
more details.

(23) Intel (i960)

Copyright (c) 1993 Intel Corporation

Intel hereby grants you permission to copy, modify, and distribute
this software and its documentation. Intel grants this permission
provided that the above copyright notice appears in all copies
and that both the copyright notice and this permission notice
appear in supporting documentation. In addition, Intel grants this
permission provided that you prominently mark as "not part of
the original" any modifications made to this software or
documentation, and that the name of Intel Corporation not be

used in advertising or publicity pertaining to distribution of the
software or the documentation without specific, written prior
permission.

Intel Corporation provides this AS IS, WITHOUT ANY
WARRANTY, EXPRESS OR

IMPLIED, INCLUDING, WITHOUT LIMITATION, ANY
WARRANTY OF MERCHANTABILITY

OR FITNESS FOR A PARTICULAR PURPOSE. Intel makes no
guarantee or representations regarding the use of, or the results
of the use of, the software and documentation in terms of
correctness, accuracy, reliability, currentness, or otherwise; and
you rely on the software, documentation and results solely at
your own risk.

IN NO EVENT SHALL INTEL BE LIABLE FOR ANY LOSS OF
USE, LOSS OF BUSINESS,

LOSS OF PROFITS, INDIRECT, INCIDENTAL, SPECIAL OR
CONSEQUENTIAL DAMAGES

OF ANY KIND. IN NO EVENT SHALL INTEL'S TOTAL LIABILITY
EXCEED THE SUM

PAID TO INTEL FOR THE PRODUCT LICENSED
HEREUNDER.

(24) Hewlett-Packard (hppa targets only)

(c) Copyright 1986 HEWLETT-PACKARD COMPANY

To anyone who acknowledges that this file is provided "AS IS"
without any express or implied warranty: permission to use,
copy, modify, and distribute this file for any purpose is hereby
granted without fee, provided that the above copyright notice and
this notice appears in all copies, and that the name of Hewlett-
Packard Company not be used in advertising or publicity
pertaining to distribution of the software without specific, written
prior permission.

Hewlett-Packard Company makes no representations about the
suitability of this software for any purpose.

(25) Henry Spencer (only *-linux targets)

Copyright 1992, 1993, 1994 Henry Spencer. All rights reserved.

This software is not subject to any license of the American
Telephone and Telegraph Company or of the Regents of the
University of California.

Permission is granted to anyone to use this software for any
purpose on any computer system, and to alter it and redistribute
it, subject to the following restrictions:

1. The author is not responsible for the consequences of use of
this software, no matter how awful, even if they arise from
flaws in it.
2. The origin of this software must not be misrepresented, either
by explicit claim or by omission. Since few users ever read
sources, credits must appear in the documentation.
3. Altered versions must be plainly marked as such, and must
not be misrepresented as being the original software. Since
few users ever read sources, credits must appear in the
documentation.
4. This notice may not be removed or altered.

(26) Mike Barcroft

Copyright (c) 2001 Mike Barcroft <mike@FreeBSD.org>

All rights reserved.

Redistribution and use in source and binary forms, with or without modification, are permitted provided that the following conditions are met:

1. Redistributions of source code must retain the above copyright notice, this list of conditions and the following disclaimer.
2. Redistributions in binary form must reproduce the above copyright notice, this list of conditions and the following disclaimer in the documentation and/or other materials provided with the distribution.

THIS SOFTWARE IS PROVIDED BY THE AUTHOR AND CONTRIBUTORS ``AS IS'' AND

ANY EXPRESS OR IMPLIED WARRANTIES, INCLUDING, BUT NOT LIMITED TO, THE

IMPLIED WARRANTIES OF MERCHANTABILITY AND FITNESS FOR A PARTICULAR PURPOSE

ARE DISCLAIMED. IN NO EVENT SHALL THE AUTHOR OR CONTRIBUTORS BE LIABLE

FOR ANY DIRECT, INDIRECT, INCIDENTAL, SPECIAL, EXEMPLARY, OR CONSEQUENTIAL

DAMAGES (INCLUDING, BUT NOT LIMITED TO, PROCUREMENT OF SUBSTITUTE GOODS

OR SERVICES; LOSS OF USE, DATA, OR PROFITS; OR BUSINESS INTERRUPTION)

HOWEVER CAUSED AND ON ANY THEORY OF LIABILITY, WHETHER IN CONTRACT, STRICT

LIABILITY, OR TORT (INCLUDING NEGLIGENCE OR OTHERWISE) ARISING IN ANY WAY

OUT OF THE USE OF THIS SOFTWARE, EVEN IF ADVISED OF THE POSSIBILITY OF

SUCH DAMAGE.

(27) Konstantin Chuguev (--enable-newlib-iconv)

Copyright (c) 1999, 2000

Konstantin Chuguev. All rights reserved.

Redistribution and use in source and binary forms, with or without modification, are permitted provided that the following conditions are met:

1. Redistributions of source code must retain the above copyright notice, this list of conditions and the following disclaimer.
2. Redistributions in binary form must reproduce the above copyright notice, this list of conditions and the following disclaimer in the documentation and/or other materials provided with the distribution.

THIS SOFTWARE IS PROVIDED BY THE AUTHOR AND CONTRIBUTORS ``AS IS'' AND

ANY EXPRESS OR IMPLIED WARRANTIES, INCLUDING, BUT NOT LIMITED TO, THE

IMPLIED WARRANTIES OF MERCHANTABILITY AND FITNESS FOR A PARTICULAR PURPOSE

ARE DISCLAIMED. IN NO EVENT SHALL THE AUTHOR OR CONTRIBUTORS BE LIABLE

FOR ANY DIRECT, INDIRECT, INCIDENTAL, SPECIAL, EXEMPLARY, OR CONSEQUENTIAL

DAMAGES (INCLUDING, BUT NOT LIMITED TO, PROCUREMENT OF SUBSTITUTE GOODS

OR SERVICES; LOSS OF USE, DATA, OR PROFITS; OR BUSINESS INTERRUPTION)

HOWEVER CAUSED AND ON ANY THEORY OF LIABILITY, WHETHER IN CONTRACT, STRICT

LIABILITY, OR TORT (INCLUDING NEGLIGENCE OR OTHERWISE) ARISING IN ANY WAY

OUT OF THE USE OF THIS SOFTWARE, EVEN IF ADVISED OF THE POSSIBILITY OF

SUCH DAMAGE.

iconv (Charset Conversion Library) v2.0

(28) Artem Bityuckiy (--enable-newlib-iconv)

Copyright (c) 2003, Artem B. Bityuckiy, SoftMine Corporation.

Rights transferred to Franklin Electronic Publishers.

Redistribution and use in source and binary forms, with or without modification, are permitted provided that the following conditions are met:

1. Redistributions of source code must retain the above copyright notice, this list of conditions and the following disclaimer.
2. Redistributions in binary form must reproduce the above copyright notice, this list of conditions and the following disclaimer in the documentation and/or other materials provided with the distribution.

THIS SOFTWARE IS PROVIDED BY THE AUTHOR AND CONTRIBUTORS ``AS IS'' AND

ANY EXPRESS OR IMPLIED WARRANTIES, INCLUDING, BUT NOT LIMITED TO, THE

IMPLIED WARRANTIES OF MERCHANTABILITY AND FITNESS FOR A PARTICULAR PURPOSE

ARE DISCLAIMED. IN NO EVENT SHALL THE AUTHOR OR CONTRIBUTORS BE LIABLE

FOR ANY DIRECT, INDIRECT, INCIDENTAL, SPECIAL, EXEMPLARY, OR CONSEQUENTIAL

DAMAGES (INCLUDING, BUT NOT LIMITED TO, PROCUREMENT OF SUBSTITUTE GOODS

OR SERVICES; LOSS OF USE, DATA, OR PROFITS; OR BUSINESS INTERRUPTION)

HOWEVER CAUSED AND ON ANY THEORY OF LIABILITY, WHETHER IN CONTRACT, STRICT

LIABILITY, OR TORT (INCLUDING NEGLIGENCE OR OTHERWISE) ARISING IN ANY WAY

OUT OF THE USE OF THIS SOFTWARE, EVEN IF ADVISED OF THE POSSIBILITY OF

SUCH DAMAGE.

(29) IBM, Sony, Toshiba (only spu-* targets)

(C) Copyright 2001,2006,

International Business Machines Corporation,

Sony Computer Entertainment, Incorporated,

Toshiba Corporation,

All rights reserved.

Redistribution and use in source and binary forms, with or without modification, are permitted provided that the following conditions are met:

- * Redistributions of source code must retain the above copyright notice, this list of conditions and the following disclaimer.
- * Redistributions in binary form must reproduce the above copyright notice, this list of conditions and the following disclaimer in the documentation and/or other materials provided with the distribution.

* Neither the names of the copyright holders nor the names of their contributors may be used to endorse or promote products

derived from this software without specific prior written permission.

THIS SOFTWARE IS PROVIDED BY THE COPYRIGHT HOLDERS AND CONTRIBUTORS "AS IS"

AND ANY EXPRESS OR IMPLIED WARRANTIES, INCLUDING, BUT NOT LIMITED TO, THE

IMPLIED WARRANTIES OF MERCHANTABILITY AND FITNESS FOR A PARTICULAR PURPOSE

ARE DISCLAIMED. IN NO EVENT SHALL THE COPYRIGHT OWNER OR CONTRIBUTORS BE

LIABLE FOR ANY DIRECT, INDIRECT, INCIDENTAL, SPECIAL, EXEMPLARY, OR

CONSEQUENTIAL DAMAGES (INCLUDING, BUT NOT LIMITED TO, PROCUREMENT OF

SUBSTITUTE GOODS OR SERVICES; LOSS OF USE, DATA, OR PROFITS; OR BUSINESS

INTERRUPTION) HOWEVER CAUSED AND ON ANY THEORY OF LIABILITY, WHETHER IN

CONTRACT, STRICT LIABILITY, OR TORT (INCLUDING NEGLIGENCE OR OTHERWISE)

ARISING IN ANY WAY OUT OF THE USE OF THIS SOFTWARE, EVEN IF ADVISED OF THE

POSSIBILITY OF SUCH DAMAGE.

(30)- Alex Tatmanjants (targets using libc/posix)

Copyright (c) 1995 Alex Tatmanjants <alex@elvisti.kiev.ua>

at Electronni Visti IA, Kiev, Ukraine.

All rights reserved.

Redistribution and use in source and binary forms, with or without modification, are permitted provided that the following conditions are met:

1. Redistributions of source code must retain the above copyright notice, this list of conditions and the following disclaimer.
2. Redistributions in binary form must reproduce the above copyright notice, this list of conditions and the following disclaimer in the documentation and/or other materials provided with the distribution.

THIS SOFTWARE IS PROVIDED BY THE AUTHOR "AS IS" AND

ANY EXPRESS OR IMPLIED WARRANTIES, INCLUDING, BUT NOT LIMITED TO, THE

IMPLIED WARRANTIES OF MERCHANTABILITY AND FITNESS FOR A PARTICULAR PURPOSE

ARE DISCLAIMED. IN NO EVENT SHALL THE AUTHOR BE LIABLE

FOR ANY DIRECT, INDIRECT, INCIDENTAL, SPECIAL, EXEMPLARY, OR CONSEQUENTIAL

DAMAGES (INCLUDING, BUT NOT LIMITED TO, PROCUREMENT OF SUBSTITUTE GOODS

OR SERVICES; LOSS OF USE, DATA, OR PROFITS; OR BUSINESS INTERRUPTION)

HOWEVER CAUSED AND ON ANY THEORY OF LIABILITY, WHETHER IN CONTRACT, STRICT

LIABILITY, OR TORT (INCLUDING NEGLIGENCE OR OTHERWISE) ARISING IN ANY WAY

OUT OF THE USE OF THIS SOFTWARE, EVEN IF ADVISED OF THE POSSIBILITY OF

SUCH DAMAGE.

(31)- M. Warner Losh (targets using libc/posix)

Copyright (c) 1998, M. Warner Losh <imp@freebsd.org>

All rights reserved.

Redistribution and use in source and binary forms, with or without modification, are permitted provided that the following conditions are met:

1. Redistributions of source code must retain the above copyright notice, this list of conditions and the following disclaimer.
2. Redistributions in binary form must reproduce the above copyright notice, this list of conditions and the following disclaimer in the documentation and/or other materials provided with the distribution.

THIS SOFTWARE IS PROVIDED BY THE AUTHOR AND CONTRIBUTORS "AS IS" AND

ANY EXPRESS OR IMPLIED WARRANTIES, INCLUDING, BUT NOT LIMITED TO, THE

IMPLIED WARRANTIES OF MERCHANTABILITY AND FITNESS FOR A PARTICULAR PURPOSE

ARE DISCLAIMED. IN NO EVENT SHALL THE AUTHOR OR CONTRIBUTORS BE LIABLE

FOR ANY DIRECT, INDIRECT, INCIDENTAL, SPECIAL, EXEMPLARY, OR CONSEQUENTIAL

DAMAGES (INCLUDING, BUT NOT LIMITED TO, PROCUREMENT OF SUBSTITUTE GOODS

OR SERVICES; LOSS OF USE, DATA, OR PROFITS; OR BUSINESS INTERRUPTION)

HOWEVER CAUSED AND ON ANY THEORY OF LIABILITY, WHETHER IN CONTRACT, STRICT

LIABILITY, OR TORT (INCLUDING NEGLIGENCE OR OTHERWISE) ARISING IN ANY WAY

OUT OF THE USE OF THIS SOFTWARE, EVEN IF ADVISED OF THE POSSIBILITY OF

SUCH DAMAGE.

(32)- Andrey A. Chernov (targets using libc/posix)

Copyright (C) 1996 by Andrey A. Chernov, Moscow, Russia.

All rights reserved.

Redistribution and use in source and binary forms, with or without modification, are permitted provided that the following conditions are met:

1. Redistributions of source code must retain the above copyright notice, this list of conditions and the following disclaimer.
2. Redistributions in binary form must reproduce the above copyright notice, this list of conditions and the following disclaimer in the documentation and/or other materials provided with the distribution.

THIS SOFTWARE IS PROVIDED BY THE AUTHOR "AS IS" AND

ANY EXPRESS OR IMPLIED WARRANTIES, INCLUDING, BUT NOT LIMITED TO, THE

IMPLIED WARRANTIES OF MERCHANTABILITY AND FITNESS FOR A PARTICULAR PURPOSE

ARE DISCLAIMED. IN NO EVENT SHALL THE REGENTS OR CONTRIBUTORS BE LIABLE

FOR ANY DIRECT, INDIRECT, INCIDENTAL, SPECIAL, EXEMPLARY, OR CONSEQUENTIAL

DAMAGES (INCLUDING, BUT NOT LIMITED TO, PROCUREMENT OF SUBSTITUTE GOODS

OR SERVICES; LOSS OF USE, DATA, OR PROFITS; OR BUSINESS INTERRUPTION)

HOWEVER CAUSED AND ON ANY THEORY OF LIABILITY, WHETHER IN CONTRACT, STRICT

LIABILITY, OR TORT (INCLUDING NEGLIGENCE OR OTHERWISE) ARISING IN ANY WAY

OUT OF THE USE OF THIS SOFTWARE, EVEN IF ADVISED OF THE POSSIBILITY OF

SUCH DAMAGE.

(33)- Daniel Eischen (targets using libc/posix)

Copyright (c) 2001 Daniel Eischen <deischen@FreeBSD.org>.

All rights reserved.

Redistribution and use in source and binary forms, with or without modification, are permitted provided that the following conditions are met:

1. Redistributions of source code must retain the above copyright notice, this list of conditions and the following disclaimer.
2. Redistributions in binary form must reproduce the above copyright notice, this list of conditions and the following disclaimer in the documentation and/or other materials provided with the distribution.

THIS SOFTWARE IS PROVIDED BY THE AUTHOR AND CONTRIBUTORS ``AS IS'' AND

ANY EXPRESS OR IMPLIED WARRANTIES, INCLUDING, BUT NOT LIMITED TO, THE

IMPLIED WARRANTIES OF MERCHANTABILITY AND FITNESS FOR A PARTICULAR PURPOSE

ARE DISCLAIMED. IN NO EVENT SHALL THE REGENTS OR CONTRIBUTORS BE LIABLE

FOR ANY DIRECT, INDIRECT, INCIDENTAL, SPECIAL, EXEMPLARY, OR CONSEQUENTIAL

DAMAGES (INCLUDING, BUT NOT LIMITED TO, PROCUREMENT OF SUBSTITUTE GOODS

OR SERVICES; LOSS OF USE, DATA, OR PROFITS; OR BUSINESS INTERRUPTION)

HOWEVER CAUSED AND ON ANY THEORY OF LIABILITY, WHETHER IN CONTRACT, STRICT

LIABILITY, OR TORT (INCLUDING NEGLIGENCE OR OTHERWISE) ARISING IN ANY WAY

OUT OF THE USE OF THIS SOFTWARE, EVEN IF ADVISED OF THE POSSIBILITY OF

SUCH DAMAGE.

(34)- Jon Beniston (only lm32-* targets)

Contributed by Jon Beniston <jon@beniston.com>

Redistribution and use in source and binary forms, with or without modification, are permitted provided that the following conditions are met:

1. Redistributions of source code must retain the above copyright notice, this list of conditions and the following disclaimer.
2. Redistributions in binary form must reproduce the above copyright notice, this list of conditions and the following disclaimer in the documentation and/or other materials provided with the distribution.

THIS SOFTWARE IS PROVIDED BY THE AUTHOR AND CONTRIBUTORS ``AS IS'' AND

ANY EXPRESS OR IMPLIED WARRANTIES, INCLUDING, BUT NOT LIMITED TO, THE

IMPLIED WARRANTIES OF MERCHANTABILITY AND FITNESS FOR A PARTICULAR PURPOSE

ARE DISCLAIMED. IN NO EVENT SHALL THE AUTHOR OR CONTRIBUTORS BE LIABLE

FOR ANY DIRECT, INDIRECT, INCIDENTAL, SPECIAL, EXEMPLARY, OR CONSEQUENTIAL

DAMAGES (INCLUDING, BUT NOT LIMITED TO, PROCUREMENT OF SUBSTITUTE GOODS

OR SERVICES; LOSS OF USE, DATA, OR PROFITS; OR BUSINESS INTERRUPTION)

HOWEVER CAUSED AND ON ANY THEORY OF LIABILITY, WHETHER IN CONTRACT, STRICT

LIABILITY, OR TORT (INCLUDING NEGLIGENCE OR OTHERWISE) ARISING IN ANY WAY

OUT OF THE USE OF THIS SOFTWARE, EVEN IF ADVISED OF THE POSSIBILITY OF

SUCH DAMAGE.

(35)- ARM Ltd (arm and thumb variant targets only)

Copyright (c) 2009 ARM Ltd

All rights reserved.

Redistribution and use in source and binary forms, with or without modification, are permitted provided that the following conditions are met:

1. Redistributions of source code must retain the above copyright notice, this list of conditions and the following disclaimer.
2. Redistributions in binary form must reproduce the above copyright notice, this list of conditions and the following disclaimer in the documentation and/or other materials provided with the distribution.
3. The name of the company may not be used to endorse or promote products derived from this software without specific prior written permission.

THIS SOFTWARE IS PROVIDED BY ARM LTD ``AS IS'' AND ANY EXPRESS OR IMPLIED

WARRANTIES, INCLUDING, BUT NOT LIMITED TO, THE IMPLIED WARRANTIES OF

MERCHANTABILITY AND FITNESS FOR A PARTICULAR PURPOSE ARE DISCLAIMED.

IN NO EVENT SHALL ARM LTD BE LIABLE FOR ANY DIRECT, INDIRECT, INCIDENTAL,

SPECIAL, EXEMPLARY, OR CONSEQUENTIAL DAMAGES (INCLUDING, BUT NOT LIMITED

TO, PROCUREMENT OF SUBSTITUTE GOODS OR SERVICES; LOSS OF USE, DATA, OR

PROFITS; OR BUSINESS INTERRUPTION) HOWEVER CAUSED AND ON ANY THEORY OF

LIABILITY, WHETHER IN CONTRACT, STRICT LIABILITY, OR TORT (INCLUDING

NEGLIGENCE OR OTHERWISE) ARISING IN ANY WAY OUT OF THE USE OF THIS

SOFTWARE, EVEN IF ADVISED OF THE POSSIBILITY OF SUCH DAMAGE.

(36)- Xilinx, Inc. (microblaze-* and powerpc-* targets)

Copyright (c) 2004, 2009 Xilinx, Inc. All rights reserved.

Redistribution and use in source and binary forms, with or without modification, are permitted provided that the following conditions are met:

1. Redistributions source code must retain the above copyright notice, this list of conditions and the following disclaimer.
2. Redistributions in binary form must reproduce the above copyright notice, this list of conditions and the following disclaimer in the documentation and/or other materials provided with the distribution.
3. Neither the name of Xilinx nor the names of its contributors may be used to endorse or promote products derived from this software without specific prior written permission.

THIS SOFTWARE IS PROVIDED BY THE COPYRIGHT HOLDER AND CONTRIBUTORS "AS IS" AND ANY EXPRESS OR IMPLIED WARRANTIES, INCLUDING, BUT NOT LIMITED TO, THE IMPLIED WARRANTIES OF MERCHANTABILITY AND FITNESS FOR A PARTICULAR PURPOSE ARE DISCLAIMED. IN NO EVENT SHALL THE COPYRIGHT HOLDER OR CONTRIBUTORS BE LIABLE FOR ANY DIRECT, INDIRECT, INCIDENTAL, SPECIAL, EXEMPLARY, OR CONSEQUENTIAL DAMAGES (INCLUDING, BUT NOT LIMITED TO, PROCUREMENT OF SUBSTITUTE GOODS OR SERVICES; LOSS OF USE, DATA, OR PROFITS; OR BUSINESS INTERRUPTION) HOWEVER CAUSED AND ON ANY THEORY OF LIABILITY, WHETHER IN CONTRACT, STRICT LIABILITY, OR TORT (INCLUDING NEGLIGENCE OR OTHERWISE) ARISING IN ANY WAY OUT OF THE USE OF THIS SOFTWARE, EVEN IF ADVISED OF THE POSSIBILITY OF SUCH DAMAGE.

(37) Texas Instruments Incorporated (tic6x-*, *-tirtos targets)

Copyright (c) 1996-2010,2014 Texas Instruments Incorporated

<http://www.ti.com/>

Redistribution and use in source and binary forms, with or without modification, are permitted provided that the following conditions are met:

Redistributions of source code must retain the above copyright notice, this list of conditions and the following disclaimer.

Redistributions in binary form must reproduce the above copyright notice, this list of conditions and the following disclaimer in the documentation and/or other materials provided with the distribution.

Neither the name of Texas Instruments Incorporated nor the names of its contributors may be used to endorse or promote products derived from this software without specific prior written permission.

THIS SOFTWARE IS PROVIDED BY THE COPYRIGHT HOLDERS AND CONTRIBUTORS

"AS IS" AND ANY EXPRESS OR IMPLIED WARRANTIES, INCLUDING, BUT NOT

LIMITED TO, THE IMPLIED WARRANTIES OF MERCHANTABILITY AND FITNESS FOR

A PARTICULAR PURPOSE ARE DISCLAIMED. IN NO EVENT SHALL THE COPYRIGHT

OWNER OR CONTRIBUTORS BE LIABLE FOR ANY DIRECT, INDIRECT, INCIDENTAL,

SPECIAL, EXEMPLARY, OR CONSEQUENTIAL DAMAGES (INCLUDING, BUT NOT

LIMITED TO, PROCUREMENT OF SUBSTITUTE GOODS OR SERVICES; LOSS OF USE, DATA, OR PROFITS; OR BUSINESS INTERRUPTION) HOWEVER CAUSED AND ON ANY THEORY OF LIABILITY, WHETHER IN CONTRACT, STRICT LIABILITY, OR TORT (INCLUDING NEGLIGENCE OR OTHERWISE) ARISING IN ANY WAY OUT OF THE USE OF THIS SOFTWARE, EVEN IF ADVISED OF THE POSSIBILITY OF SUCH DAMAGE.

(38) National Semiconductor (cr16-* and crx-* targets)

Copyright (c) 2004 National Semiconductor Corporation

The authors hereby grant permission to use, copy, modify, distribute, and license this software and its documentation for any purpose, provided that existing copyright notices are retained in all copies and that this notice is included verbatim in any distributions. No written agreement, license, or royalty fee is required for any of the authorized uses.

Modifications to this software may be copyrighted by their authors and need not follow the licensing terms described here, provided that the new terms are clearly indicated on the first page of each file where they apply.

(39) - Adapteva, Inc. (epiphany-* targets)

Copyright (c) 2011, Adapteva, Inc.

All rights reserved.

Redistribution and use in source and binary forms, with or without modification, are permitted provided that the following conditions are met:

* Redistributions of source code must retain the above copyright notice, this list of conditions and the following disclaimer.

* Redistributions in binary form must reproduce the above copyright notice, this list of conditions and the following disclaimer in the documentation and/or other materials provided with the distribution.

* Neither the name of Adapteva nor the names of its contributors may be used to endorse or promote products derived from this software without specific prior written permission.

THIS SOFTWARE IS PROVIDED BY THE COPYRIGHT HOLDERS AND CONTRIBUTORS "AS IS" AND

ANY EXPRESS OR IMPLIED WARRANTIES, INCLUDING, BUT NOT LIMITED TO, THE IMPLIED

WARRANTIES OF MERCHANTABILITY AND FITNESS FOR A PARTICULAR PURPOSE ARE

DISCLAIMED. IN NO EVENT SHALL THE COPYRIGHT HOLDER OR CONTRIBUTORS BE LIABLE

FOR ANY DIRECT, INDIRECT, INCIDENTAL, SPECIAL, EXEMPLARY, OR CONSEQUENTIAL

DAMAGES (INCLUDING, BUT NOT LIMITED TO, PROCUREMENT OF SUBSTITUTE GOODS OR

SERVICES; LOSS OF USE, DATA, OR PROFITS; OR BUSINESS INTERRUPTION) HOWEVER

CAUSED AND ON ANY THEORY OF LIABILITY, WHETHER IN CONTRACT, STRICT LIABILITY,

OR TORT (INCLUDING NEGLIGENCE OR OTHERWISE) ARISING IN ANY WAY OUT OF THE USE

OF THIS SOFTWARE, EVEN IF ADVISED OF THE POSSIBILITY OF SUCH DAMAGE.

(40) - Altera Corporation (nios2-* targets)

Copyright (c) 2003 Altera Corporation

All rights reserved.

Redistribution and use in source and binary forms, with or without

modification, are permitted provided that the following conditions are met:

- o Redistributions of source code must retain the above copyright notice, this list of conditions and the following disclaimer.
- o Redistributions in binary form must reproduce the above copyright notice, this list of conditions and the following disclaimer in the documentation and/or other materials provided with the distribution.
- o Neither the name of Altera Corporation nor the names of its contributors may be used to endorse or promote products derived from this software without specific prior written permission.

THIS SOFTWARE IS PROVIDED BY ALTERA CORPORATION, THE COPYRIGHT HOLDER,

AND ITS CONTRIBUTORS "AS IS" AND ANY EXPRESS OR IMPLIED WARRANTIES,

INCLUDING, BUT NOT LIMITED TO, THE IMPLIED WARRANTIES OF MERCHANTABILITY

AND FITNESS FOR A PARTICULAR PURPOSE ARE DISCLAIMED. IN NO EVENT SHALL

THE COPYRIGHT HOLDER OR CONTRIBUTORS BE LIABLE FOR ANY DIRECT, INDIRECT,

INCIDENTAL, SPECIAL, EXEMPLARY, OR CONSEQUENTIAL DAMAGES (INCLUDING,

BUT NOT LIMITED TO, PROCUREMENT OF SUBSTITUTE GOODS OR SERVICES; LOSS

OF USE, DATA, OR PROFITS; OR BUSINESS INTERRUPTION) HOWEVER CAUSED AND

ON ANY THEORY OF LIABILITY, WHETHER IN CONTRACT, STRICT LIABILITY, OR

TORT (INCLUDING NEGLIGENCE OR OTHERWISE) ARISING IN ANY WAY OUT OF THE

USE OF THIS SOFTWARE, EVEN IF ADVISED OF THE POSSIBILITY OF SUCH DAMAGE.

(41) Ed Schouten - Free BSD

Copyright (c) 2008 Ed Schouten <ed@FreeBSD.org>

All rights reserved.

Redistribution and use in source and binary forms, with or without modification, are permitted provided that the following conditions are met:

1. Redistributions of source code must retain the above copyright notice, this list of conditions and the following disclaimer.
2. Redistributions in binary form must reproduce the above copyright notice, this list of conditions and the following disclaimer in the documentation and/or other materials provided with the distribution.

THIS SOFTWARE IS PROVIDED BY THE AUTHOR AND CONTRIBUTORS "AS IS" AND

ANY EXPRESS OR IMPLIED WARRANTIES, INCLUDING, BUT NOT LIMITED TO, THE

IMPLIED WARRANTIES OF MERCHANTABILITY AND FITNESS FOR A PARTICULAR PURPOSE

ARE DISCLAIMED. IN NO EVENT SHALL THE AUTHOR OR CONTRIBUTORS BE LIABLE

FOR ANY DIRECT, INDIRECT, INCIDENTAL, SPECIAL, EXEMPLARY, OR CONSEQUENTIAL

DAMAGES (INCLUDING, BUT NOT LIMITED TO, PROCUREMENT OF SUBSTITUTE GOODS

OR SERVICES; LOSS OF USE, DATA, OR PROFITS; OR BUSINESS INTERRUPTION)

HOWEVER CAUSED AND ON ANY THEORY OF LIABILITY, WHETHER IN CONTRACT, STRICT

LIABILITY, OR TORT (INCLUDING NEGLIGENCE OR OTHERWISE) ARISING IN ANY WAY

OUT OF THE USE OF THIS SOFTWARE, EVEN IF ADVISED OF THE POSSIBILITY OF

SUCH DAMAGE.