



Follow these steps to install your JumboMax® Golf Grips.
A short video is also available online at www.jumbomax.com.



You will need:

- Vise mounted on work bench or table
- Rubber shaft protector
- Utility knife with hooked blade
- China marker or Sharpie pen
- Solvent-activated grip tape
- Low-odor mineral spirits (grip solvent)
- Paint tray or pail to catch solvent
- Paper towels or disposable shop towels
- Golf tee to plug hole in grip end

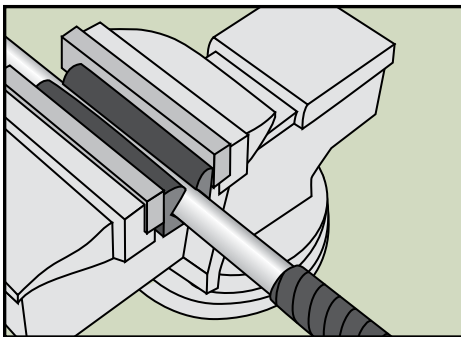

1. Place rubber shaft protector in vise, then secure golf club in vise. Tighten just enough to secure club. Do not over tighten.

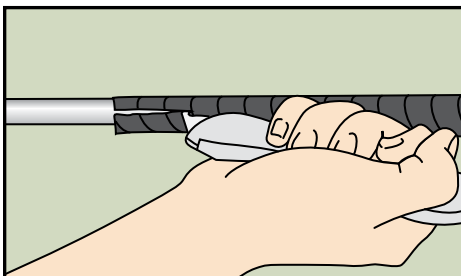

2. Remove old skinny grip by cutting down the length with the hook-bladed knife. Peel off old grip and tape and place in trash. Clean the shaft with grip solvent.

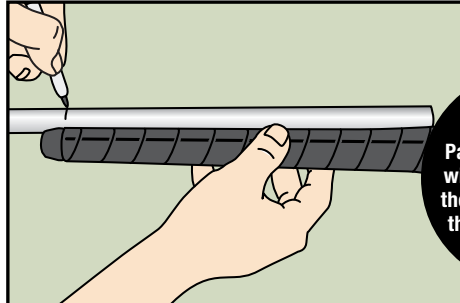

3. Hold the JumboMax Grip next to the shaft to determine how much of the shaft will be covered by the grip. Mark one inch from end of the grip with china marker.

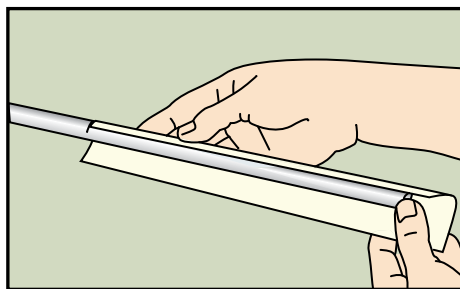

4. Apply double-sided grip tape beginning at your mark and leaving an inch overlap at the shaft butt.

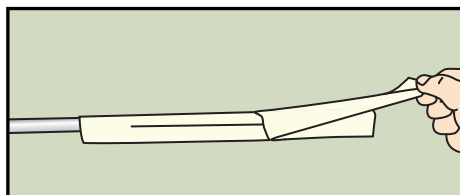

5. Smooth the tape as you go, then before tacking down second edge, peel off the tape backing. Finish smoothing down tape. **At the butt end, twist the tape overlap and tuck into end of the shaft. TAPE SHOULD BE SMOOTH - DO NOT SPIRAL WRAP the tape.** Tape must cover entire shaft leaving no gap.

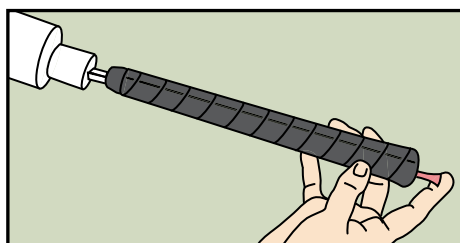

6. Plug the small hole in end of grip with golf tee. Squirt a **generous** amount of solvent into the open end of the grip. Cover open end tightly with your thumb and shake thoroughly tipping back and forth coating the **entire** inside of the grip. If the solvent isn't sloshing around inside the grip, add more and repeat. **NOTE:** Pre-stretching the opening with a blunt, smooth object slightly bigger than the opening will relax the rubber and make the grip slide on more easily.

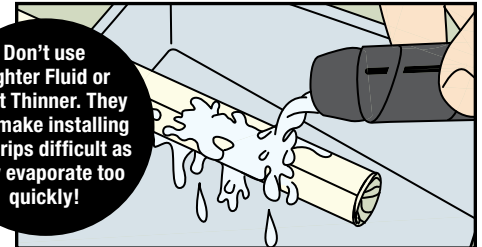

7. Now pour the remaining solvent from the grip over the tape saturating the tape well. Use extra solvent to wet it if you need more.

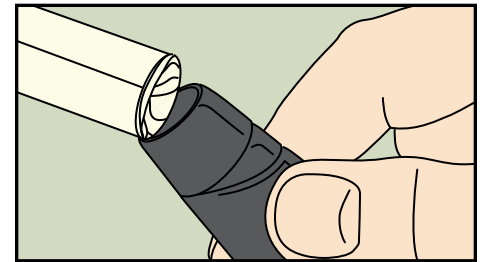

8. Remove the tee. Squeeze open end of the grip and start it over the butt end of the shaft. With both hands, push firmly while twisting to install the grip as far as it will go. If it will not go easily, pull off immediately, re-wet everything with solvent & start over.

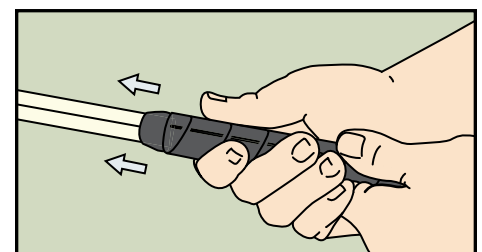

9. Look down the shaft and grip and twist the grip to align logo to the desired top location. Grip will twist until solvent evaporates. Wipe any excess glue or solvent off the shaft and grip with a solvent on paper towel, then wipe with a dry paper towel. Any excess solvent will evaporate.

10. Place a paper towel on the ground and tamp the butt end on the towel to get rid of any excess solvent inside the shaft. Allow to dry for an hour before hitting the daylight out of your new JumboMax® Gripped clubs.