

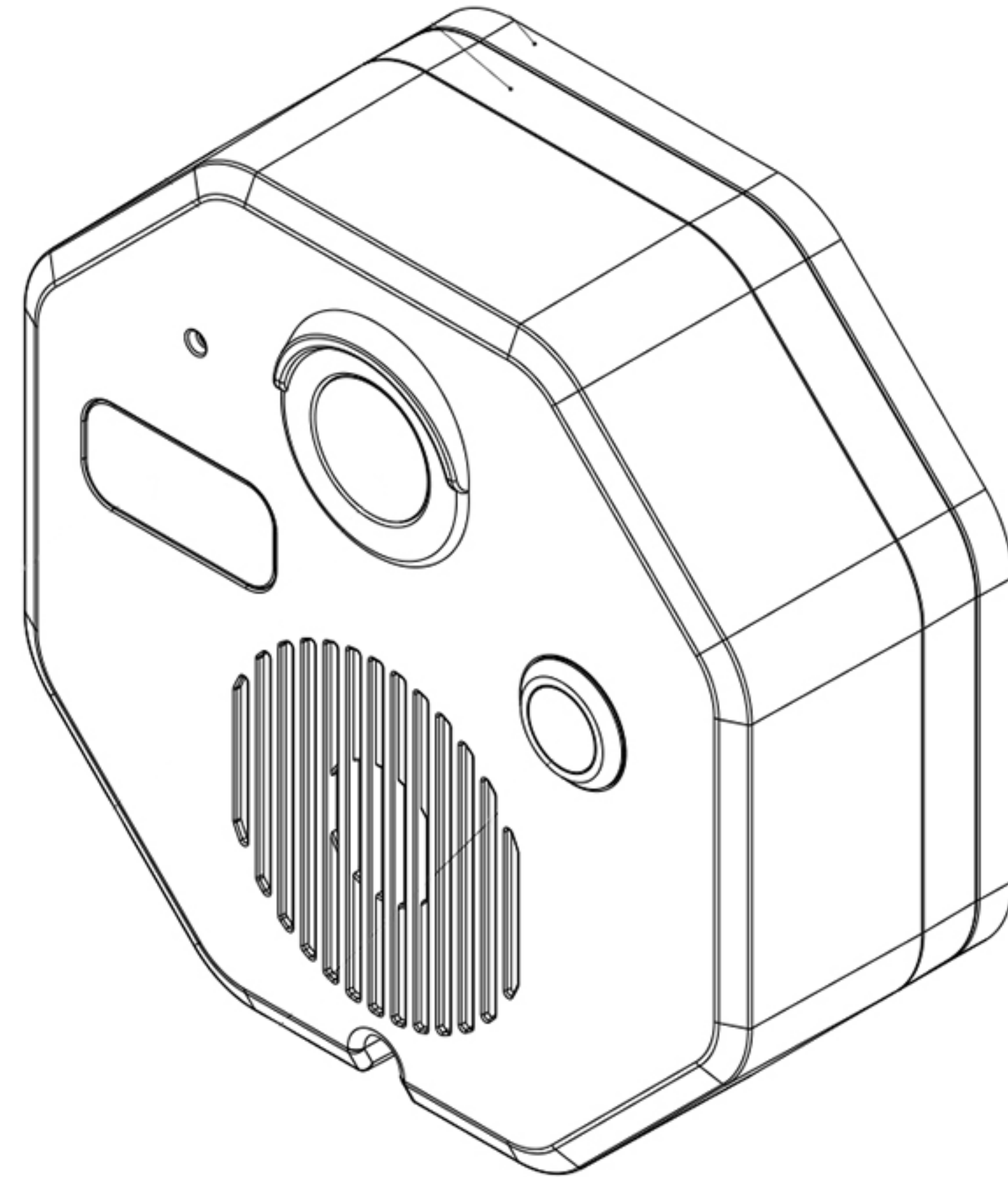

Welcome to - Sima

Install & Wiring Guide



Contents:

- Intro to Sima!
- What you need
- What's included
- Wiring diagrams (with and without separate lock power supply)
- Wiring instructions
- Support

Intro to Sima!

We love that you've chosen Sima and are ready to start your install! If you haven't already, your first step is downloading our mobile app (IOS or Android) called Active Witness. As the system administrator, you'll need an account to set up your Sima sensor(s).

Once you've downloaded the app and created your administrator profile, you'll need to add and confirm your email. Now that your profile has been made, you can start adding Sima sensors to your facility and adding users. Please visit our resources page at (insert resources link) and view our app walkthrough resources. This document will help you familiarize yourself with the app and its features.

Within our resources page you will be able to find, hardware specifications, app tutorials and walkthroughs as well as any other relevant documentation to get you set up with your Sima system.

If you're still running into issues and need assistance with app walkthroughs, remote troubleshooting or have any questions, don't hesitate to contact us. We would be happy to have a voice or video call to assist you in your setup. We can be reached at sima@activewitness.com or 1-888-719-SIMA (7462).

What you need

- 1 Phillips and Small Flathead Screwdrivers
- 2 Wire Cutters
- 3 Ethernet Cables (CAT5)
- 4 Wire Connectors
- 5 3/16-inch (5mm) Drill Bit for Wall Anchors
- 6 POE Switch with Wired Internet Connection (Ethernet)
- 7 Low voltage cables (18/2)



What's included



Connection:
Wired ethernet with
access to Internet



Lock Control Output:
· 12v
· Max 300mA on PoE
· Max 400mA on 12v input



Power Input:
· 12v · PoE







Doorbell option
Intercom option



Compatible Locks:
Any electrical lock
controller accepting 12v

*Examples: mag locks,
electrified mortise,
electrified strike plate*

GND 1	Blue 
12 V OUT0	Yellow 
GND 2	White 
12 V OUT1	Grey 

Sima wiring diagram:

No separate lock power supply

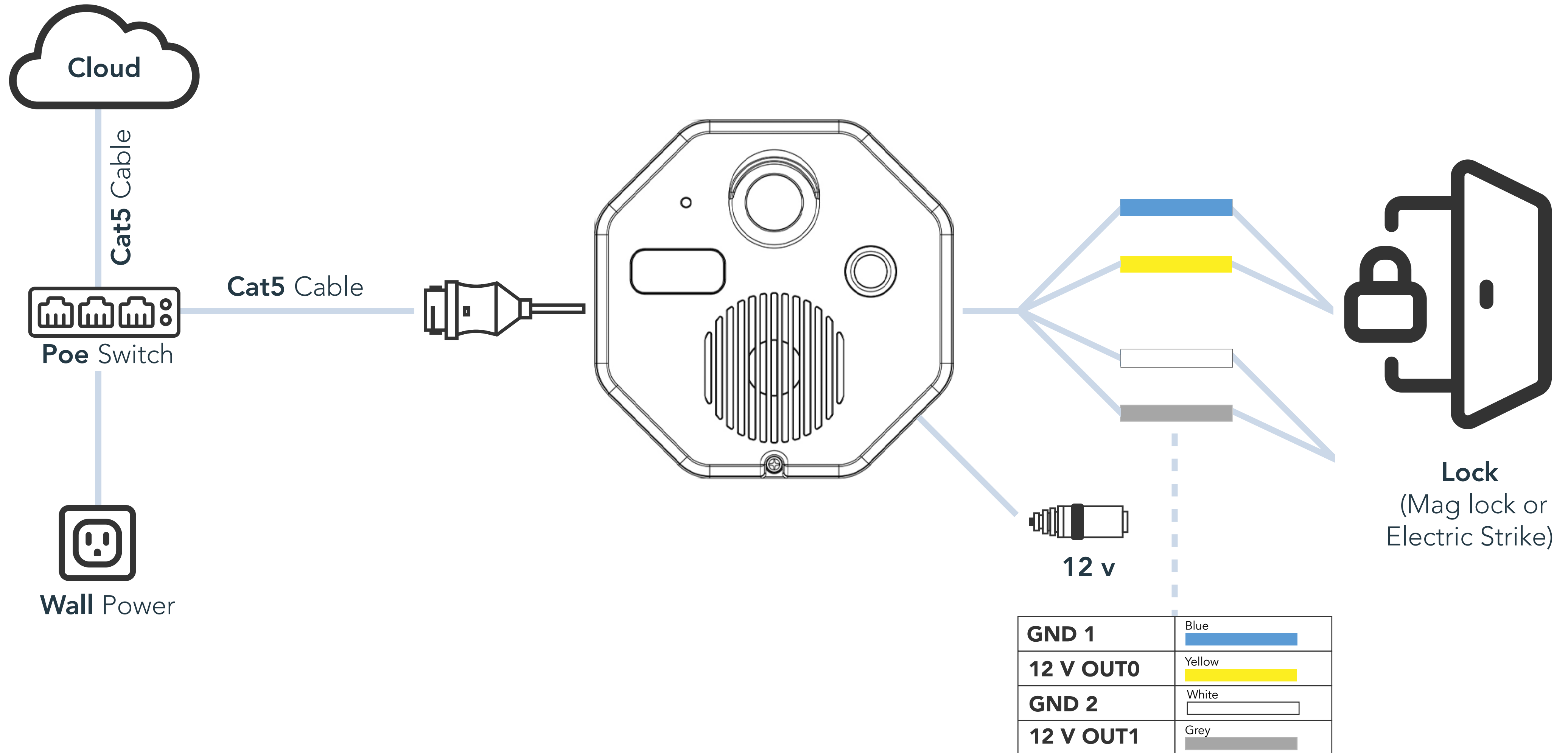

Sima wiring diagram:

With separate lock power supply

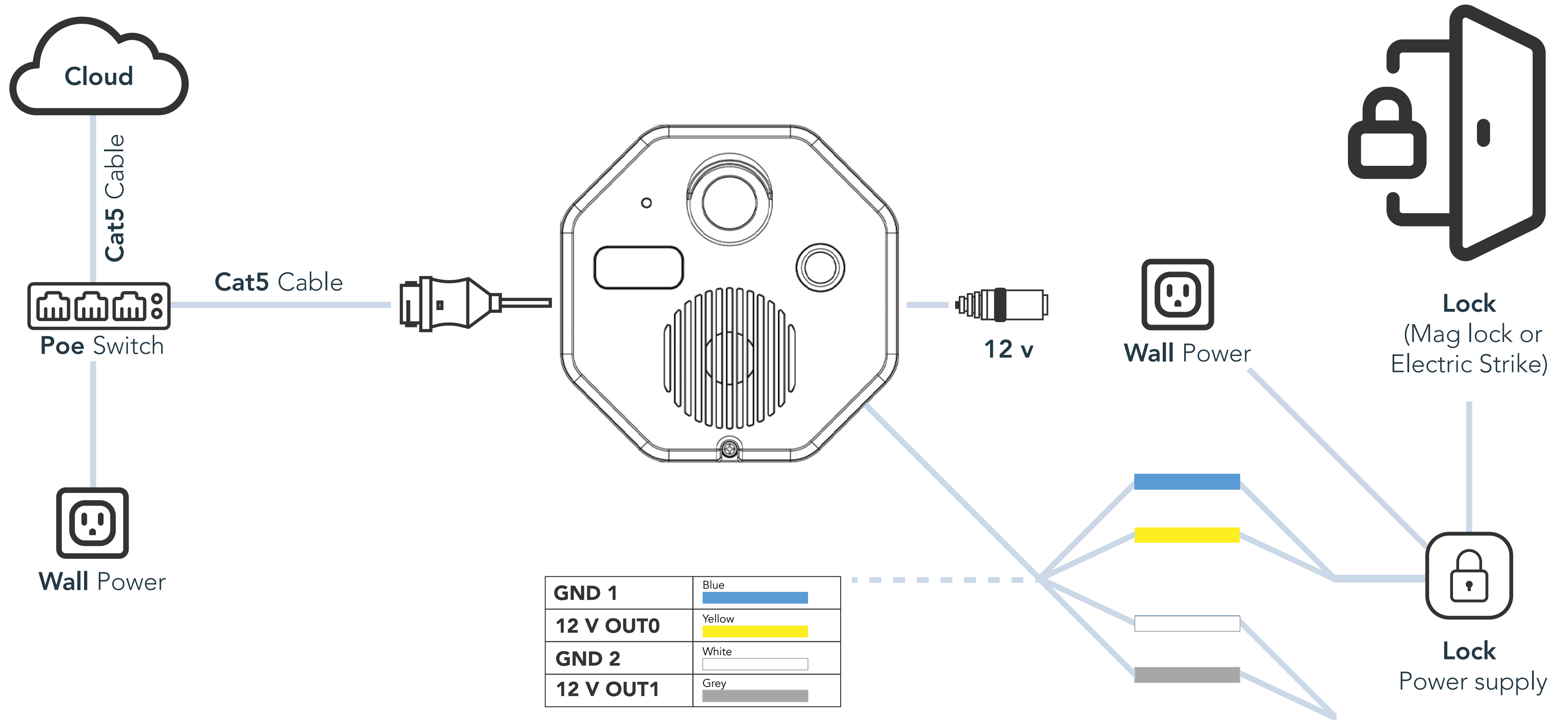

Wiring Installation - Step by Step

For the pre and post-setup of your Sima device(s) you must use the Active Witness mobile app. A how-to guide can be found on our website www.activewitness.com

Wiring installation instructions:

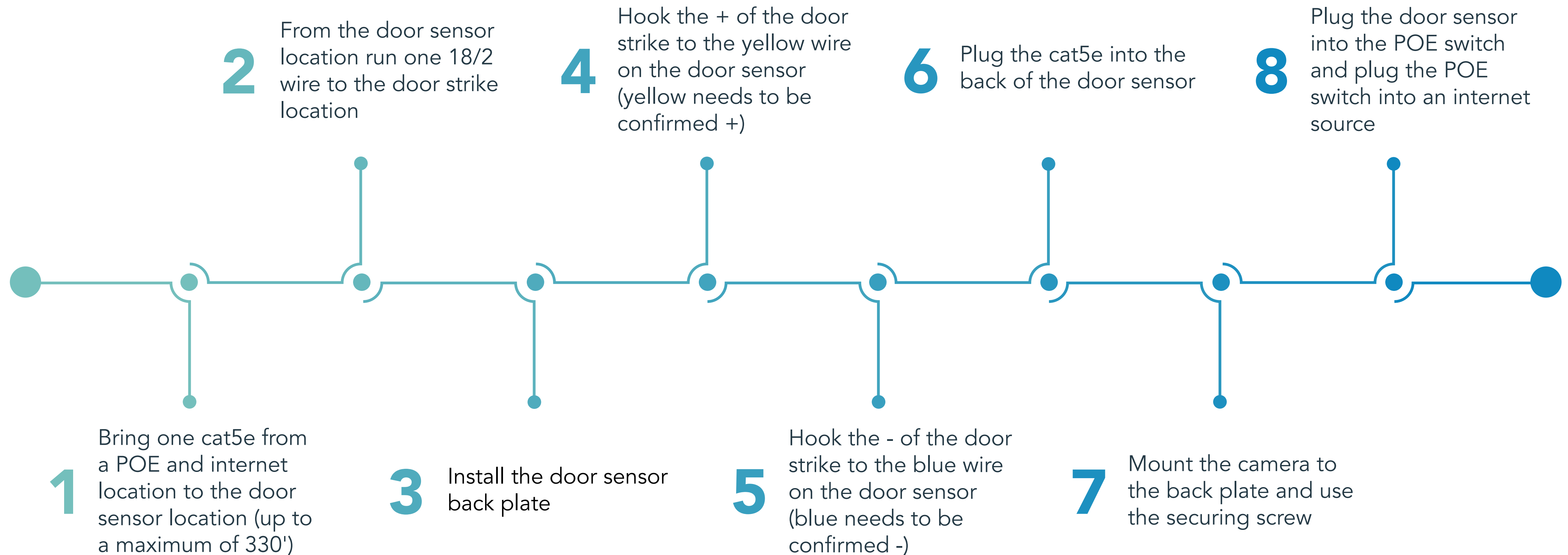

Support

Thank you for choosing Sima for your building access!

If you have any problems, please reach out and we would be happy to assist you with your remote troubleshooting.

Sincerely,

Sima

Sima@activewitness.com

1-888-719-SIMA (7462)

www.activewitness.com