

Coop Run and Run Extension User Guide

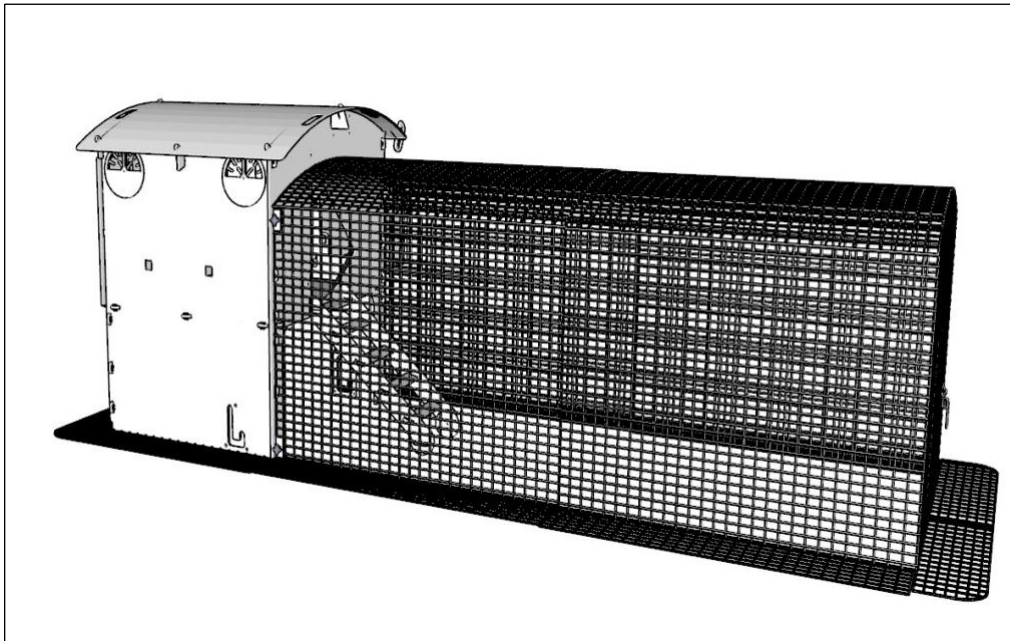
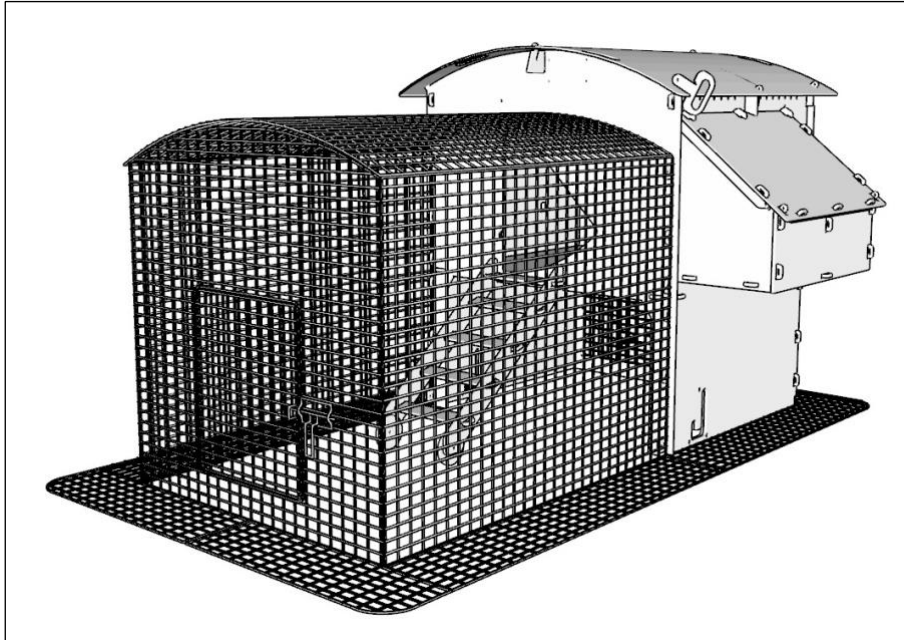

Coop Run and Run Extension Kit Components

1. Coop back door mesh
 2. Rear mud skirt left/right
 3. Side mud skirt left/right
 4. Side wall left/right
 5. Roof (curved panel)
 6. Front door
 7. Front mud skirt left/right
-

Fixing Pack for Coop Run

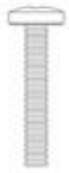

30mm Screw
Qty 4



Run fixing nut
Qty 4



Run fixing plate
Qty 4



Cable ties
Qty 65

Fixing Pack for Run Extension



Cable ties
Qty 40

Coop Run

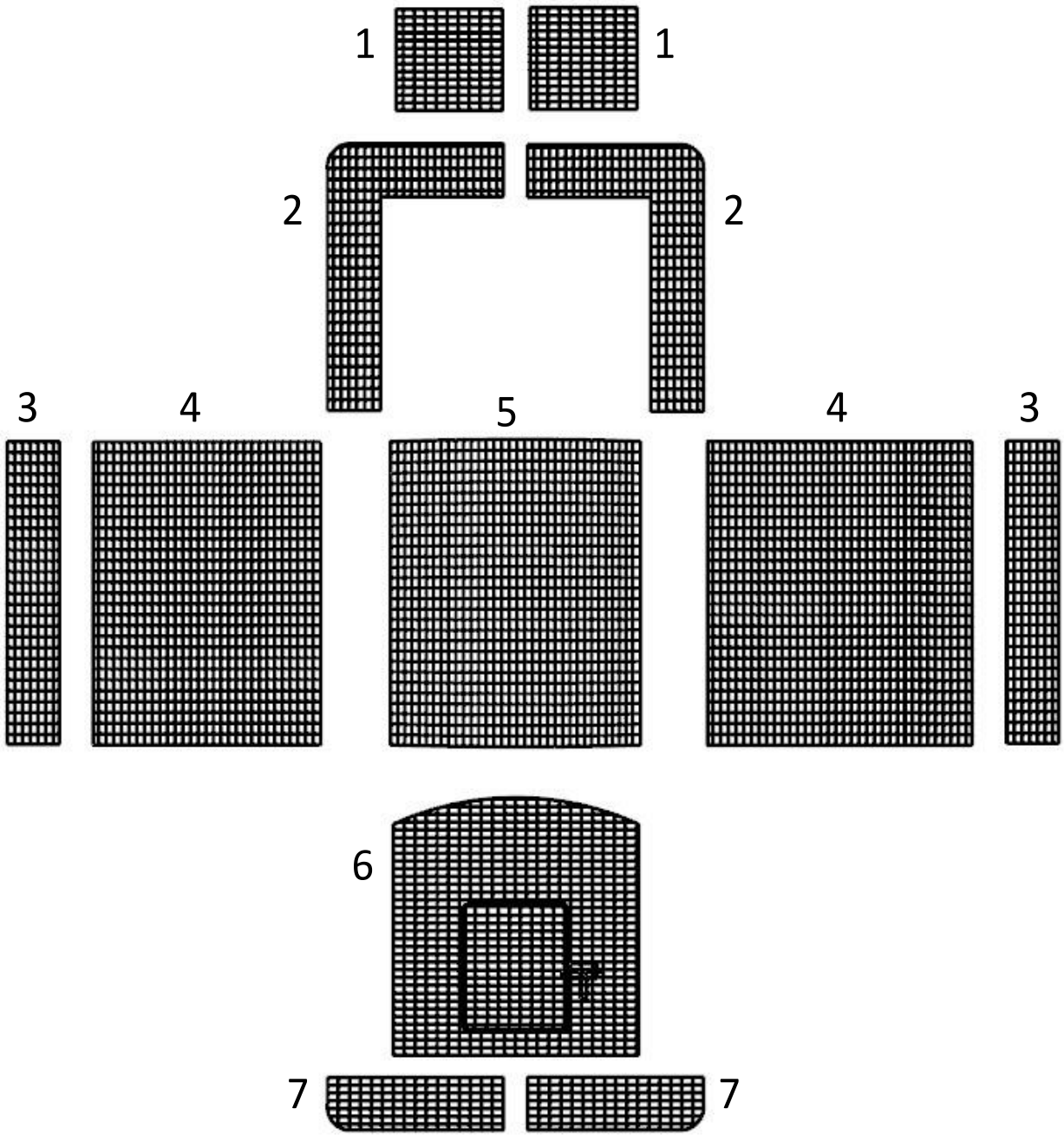

Run Extension

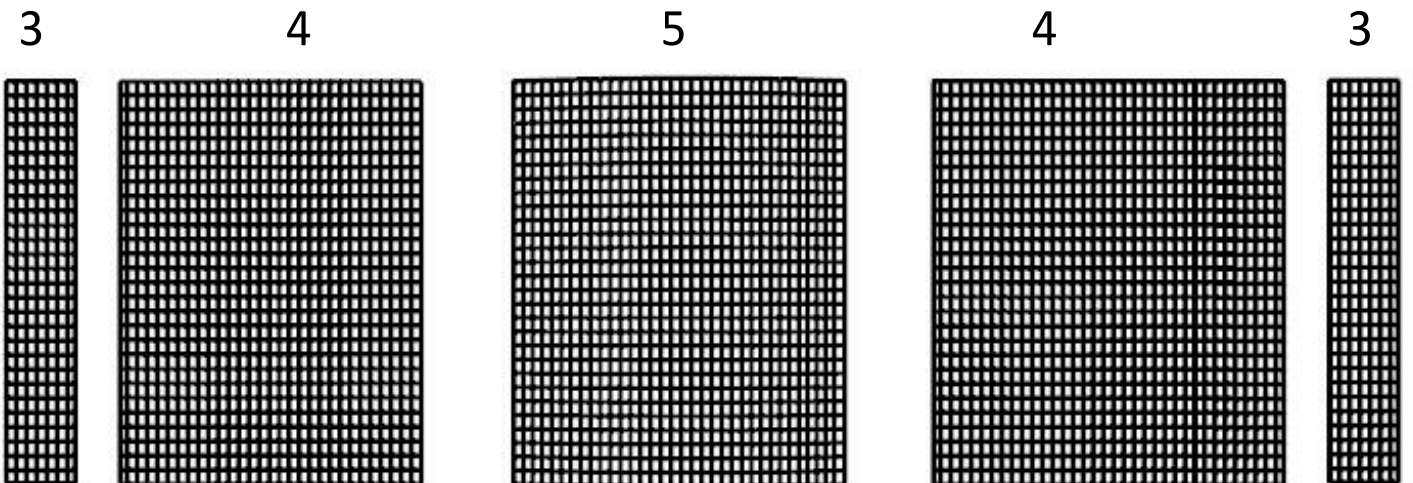

Coop Run Assembly

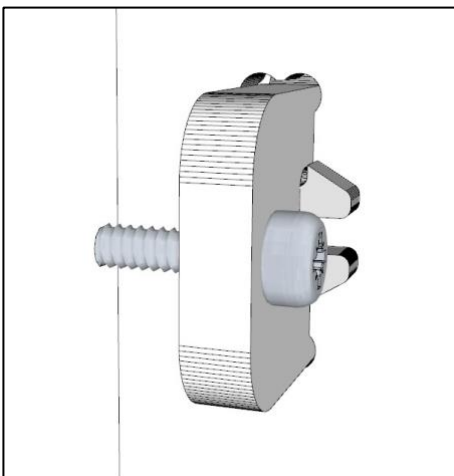
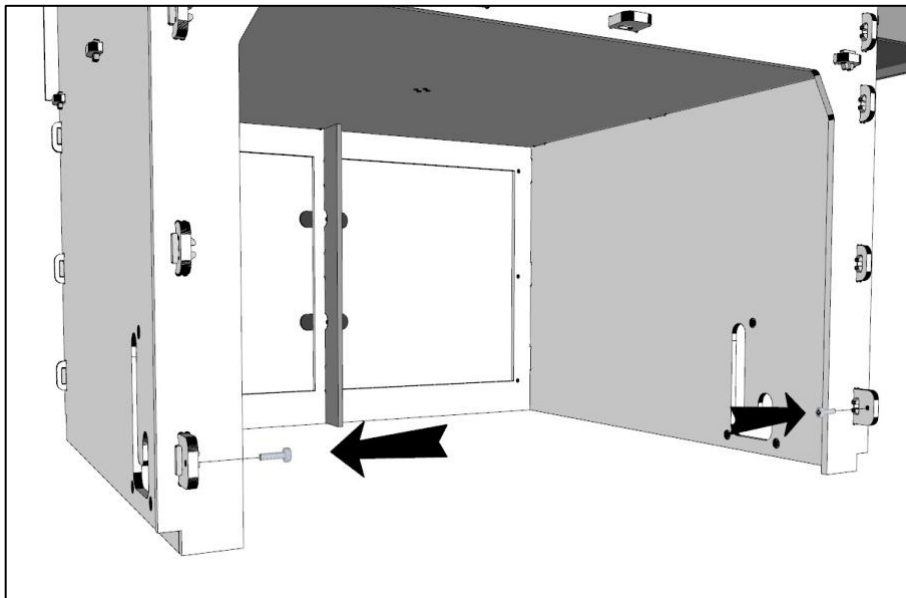
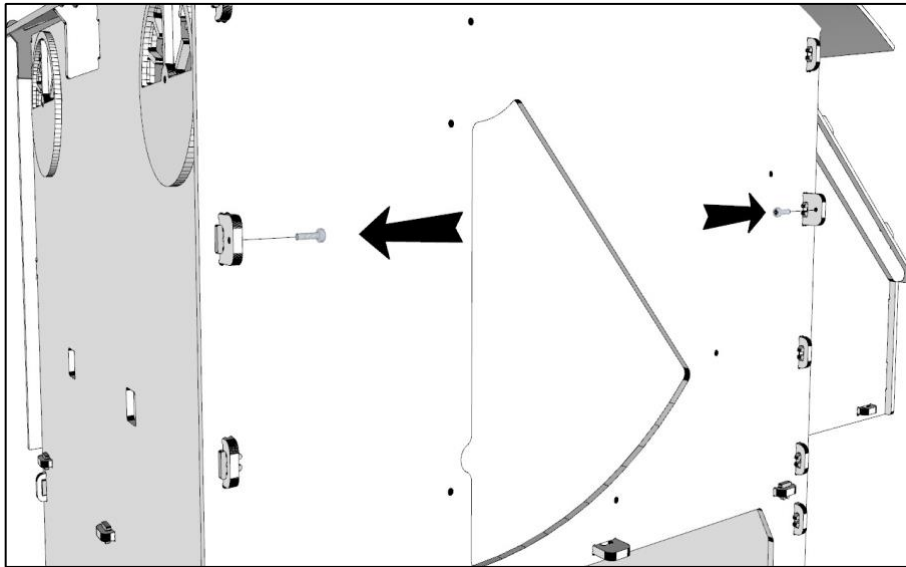

1 Fit the 30mm screws to the 4 large lugs on the front of the coop using a Phillips screwdriver.

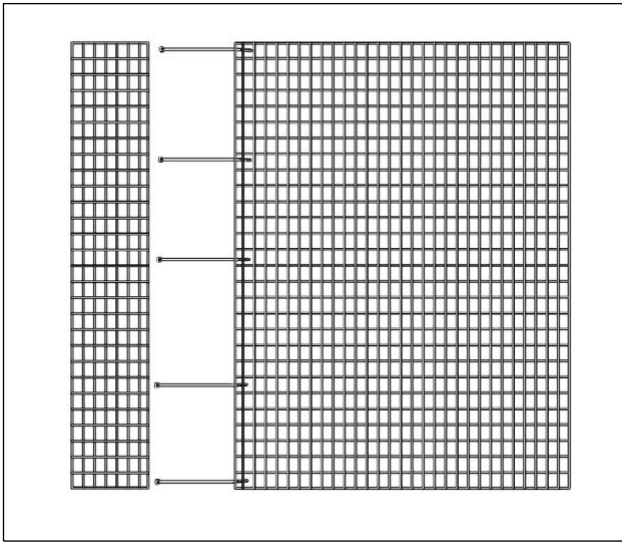

2 Connect the side mud skirt left side and side wall left with 5 cable ties. cut all excess off from the cable ties.

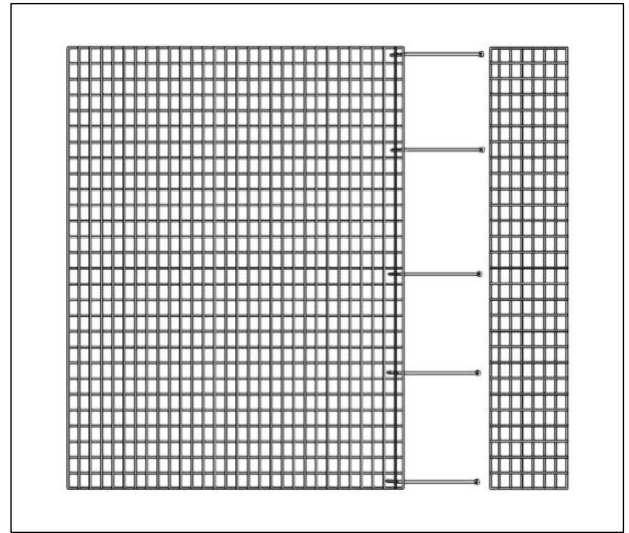

3 Connect the side mud skirt right side and side wall right with 5 cable ties.

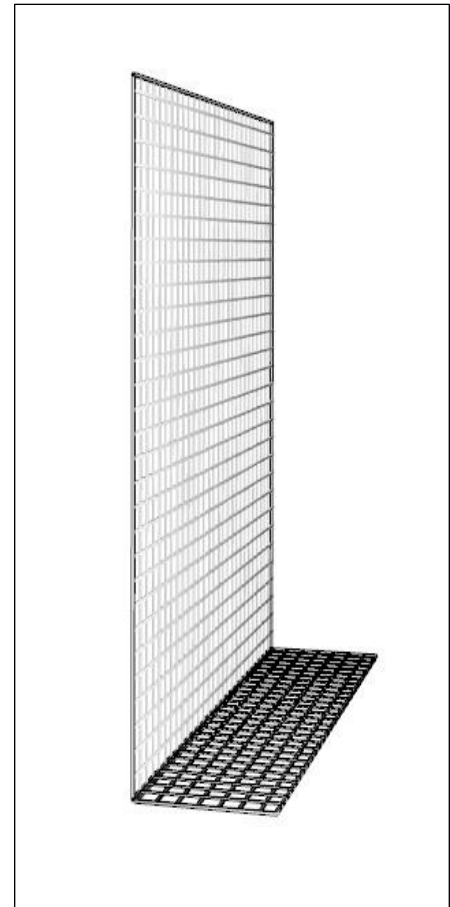
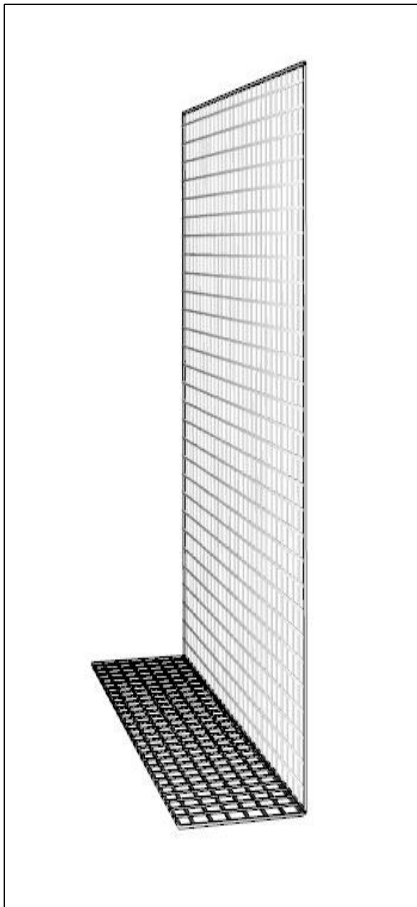

The left and right side walls will end up in an L-shape ready to attach to your Raised Coop.

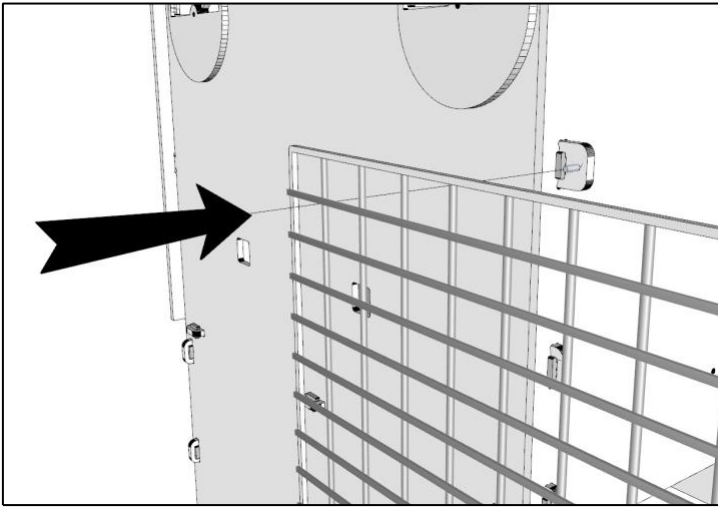

4 Fit the left and right side mesh over the 30mm screws on either side of the coop.

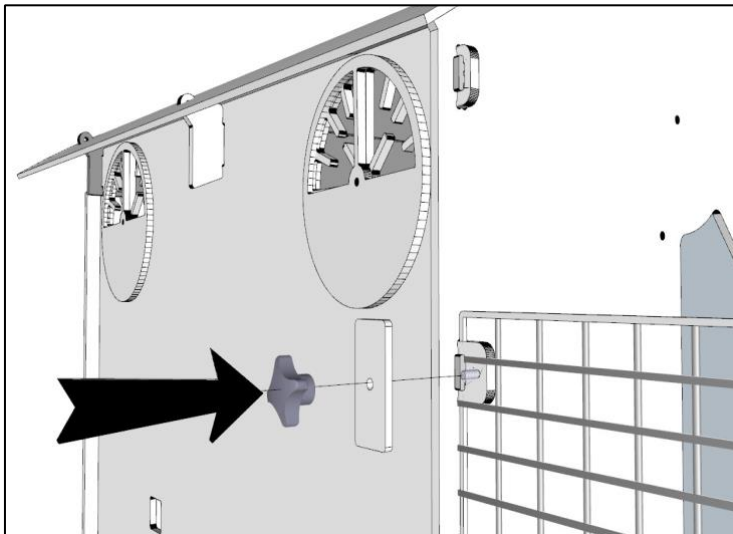

5 Attach 1 run fixing plate over the 30mm screw on the outside of the mesh.

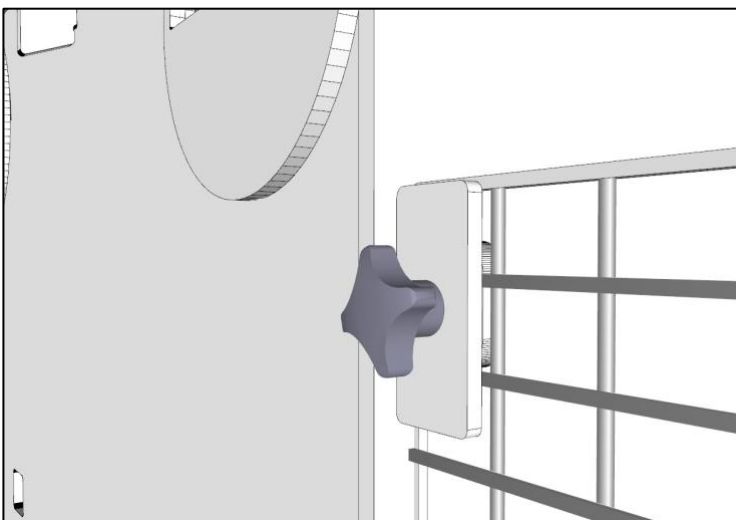

6 Tighten the run fixing nut over the top of the fixing plate, repeat on the other 3 corners.

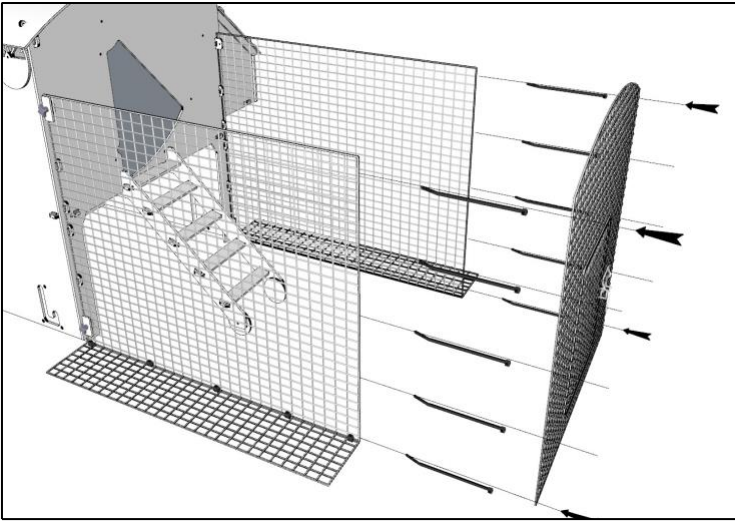

7 Attach the front door to the left and right side walls using 10 cable ties (5 either side).

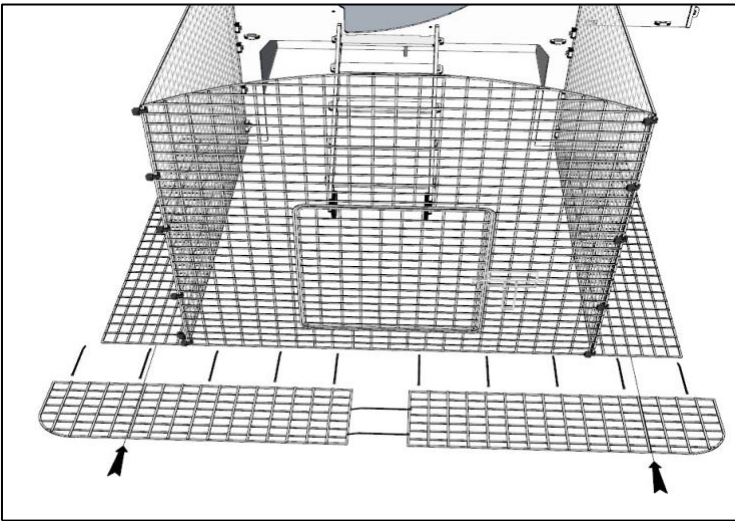

8 Fit the front mud skirts to the front door and side mud skirts using 5 cable ties on each side.

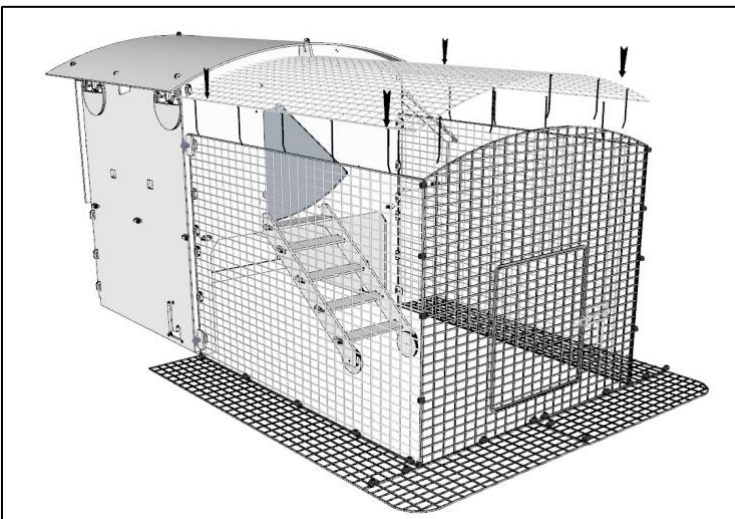

9 When fitting the roof, you may need help holding the roof in place while you attach the cable ties.

Use 5 cable ties per side of the roof.

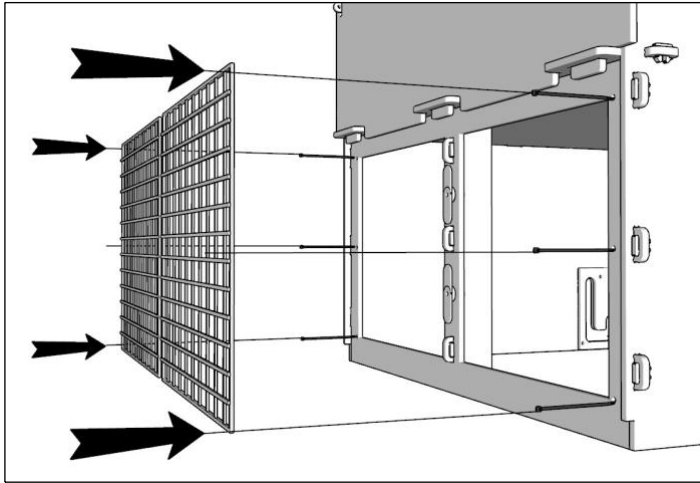

10 Attach the coop back door mesh using 3 cable ties on opposite sides of the doors. Use the locking lugs to lock the doors into place.

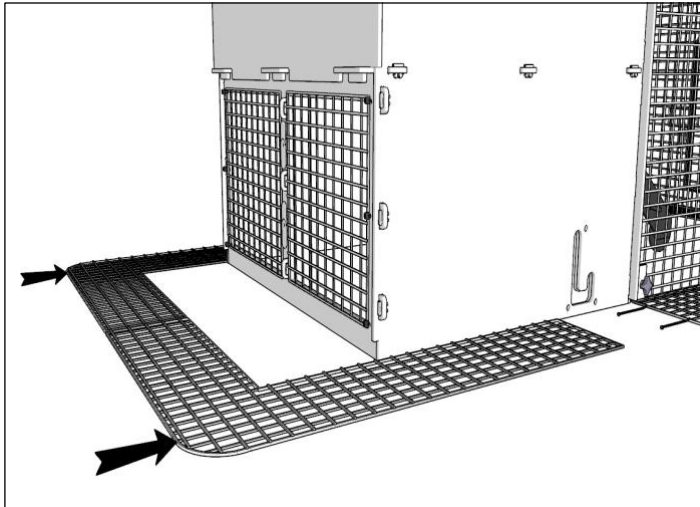

11 Slide the rear mud skirts to the back of the coop and attach to the side mud skirt with 2 cable ties at each joint. There should be 6 cable ties used for this part - 2 either side and 2 to join the rear mud skirts to each other.

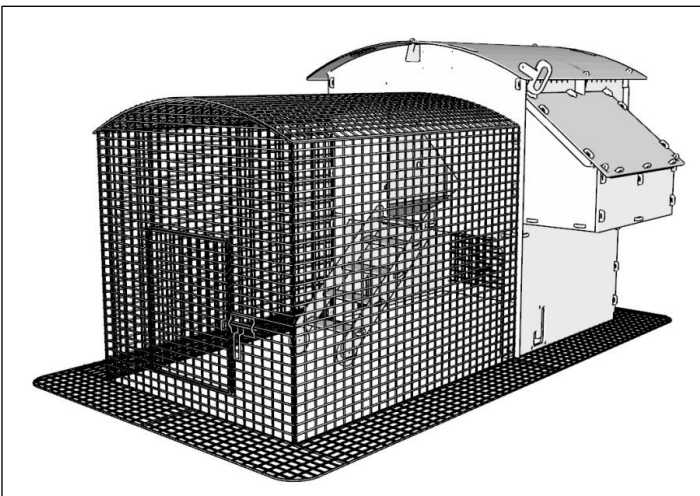

Your coop Run is now ready to be used.

How to Attach Your Run Extension

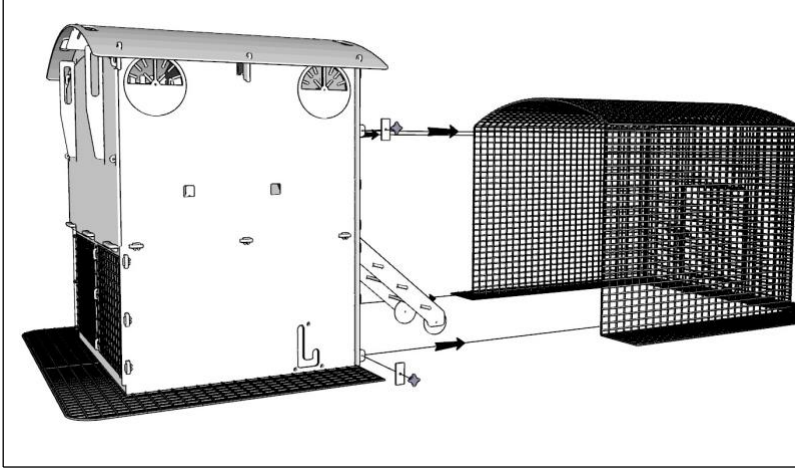

1 Unscrew and remove the run fixing plates from all four corners of your coop, slide the run away from the coop ready for fitting later.

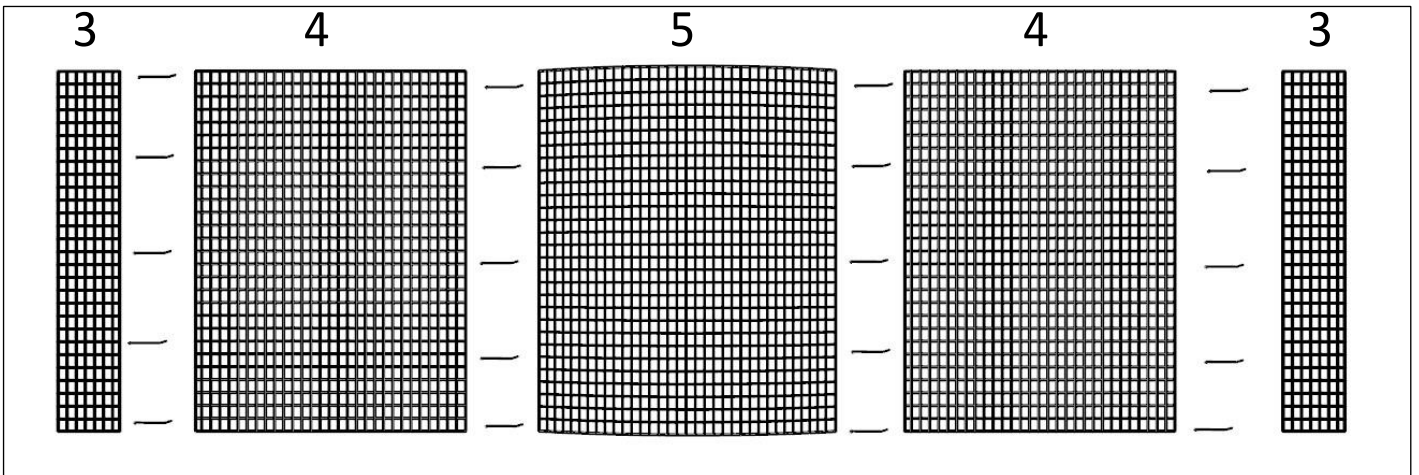

2 Lay out your extension kit on the floor as above. Attach the long edges with 5 cable ties on each side.

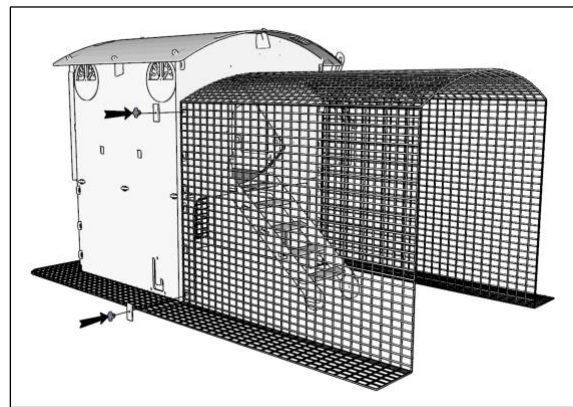
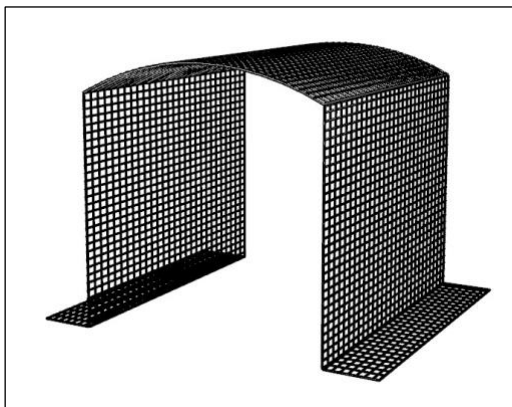

3 Lift the extension kit up and carry to the coop. We recommend this is done by two people.

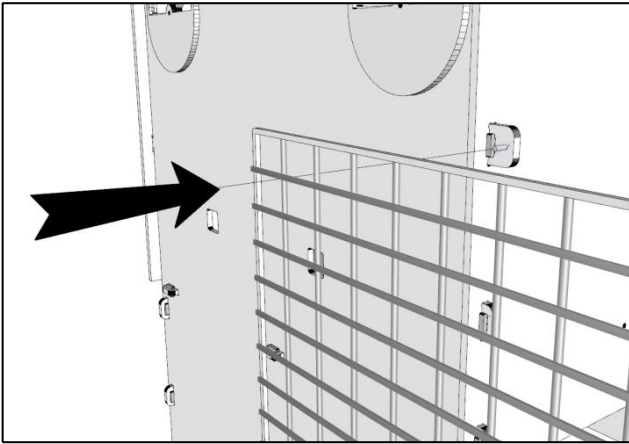

4 Fit the extension kit over the 30mm screws either side of the coop.

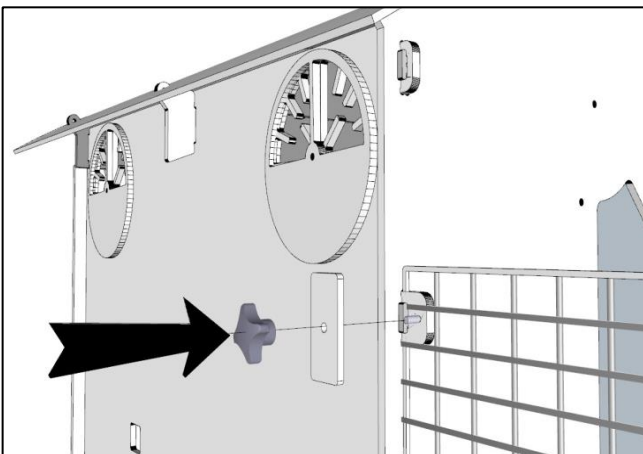

5 Attach 1 run fixing plate over the 30mm screw on the outside of the mesh.

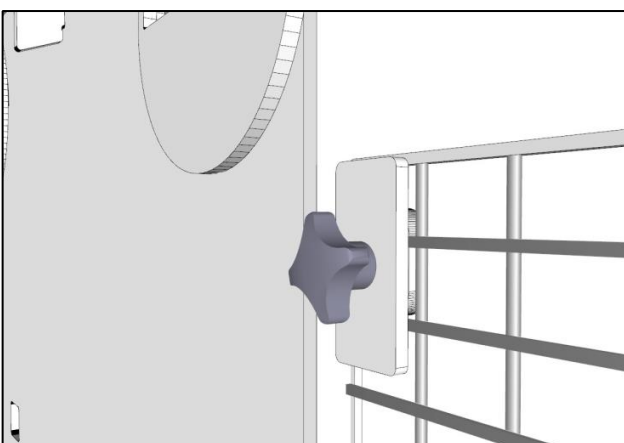

6 Tighten the run fixing nut over the top of the fixing plate, repeat on the other 3 corners.

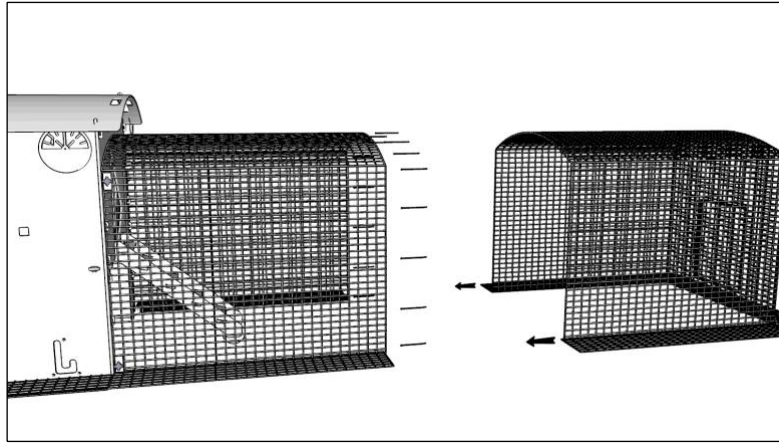

7 Slide your Run onto the Run Extension and attach using cable ties - 5 on the two sides and roof, and 2 on either side of the mud skirts.

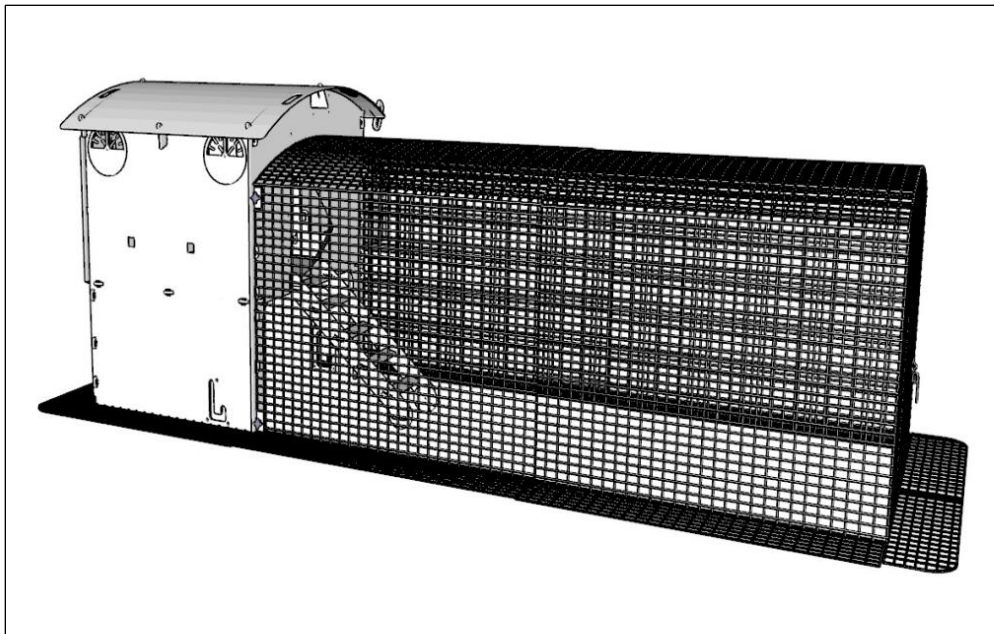

Your extended Run is now ready to be used.

