

# USERS GUIDE

## K5242 LCD



CONTENT

Preface..... 3 -

1. Appearance and Dimensions..... 4 -

    1.1 Material and Color ..... 4 -

2. Function and Button Definition..... 5 -

    2.1 Function description ..... 5 -

    2.2 Normal Display Content ..... 5 -

    2.3 Button definition ..... 5 -

3. Note for Users ..... 6 -

4. Installation Instruction ..... 6 -

5. User Settings ..... 6 -

    5.1 On / Off ..... 6 -

    5.2 User interface..... 7 -

    5.3 Walk Assist Mode..... 7 -

    5.4 PAS Level Selection..... 8 -

    5.5 Battery Indicator ..... 8 -

    5.6 Speed/Single Trip/Odometer ..... 9 -

        5.6.1 Real time speed, Trip display interface ..... 9 -

        5.6.2 Max Speed, Odometer display interface..... 10 -

        5.6.3 Avg Speed, To Go display interface ..... 10 -

    5.7 Error Code ..... 11 -

6. User Settings ..... 11 -

    6.1 Wheel Size Setting..... 12 -

    6.2 Speed Limit Setting ..... 12 -

    6.3 Backlight Brightness Setting..... 13 -

    6.4 Display Unit Setting ..... 13 -

7. Preparation Before Startup ..... 14 -

8. FAQ..... 14 -

9. Quality Assurance and Warranty Scope ..... 14 -

Appendix 1: Error Code Definition ..... 15 -

## **Preface**

Dear user, to ensure better performance of your e-bike, please read through the K5242-S product introduction carefully before using. We will use the most concise words to inform you of all the details (including the hardware installation, setting and normal operation use of the display) when using our display. Meanwhile, the introduction will also help you to solve possible confusion and barriers.

## 1. Appearance and Dimensions

### 1.1 Material and Color

K5242 products are made of black and white PC. Under the temperature of -20 to 60°C, the shell material can ensure normal usage and good mechanical performance.

Dimension (unit: mm)

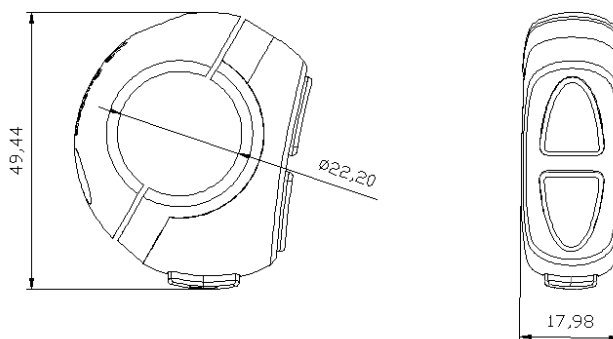
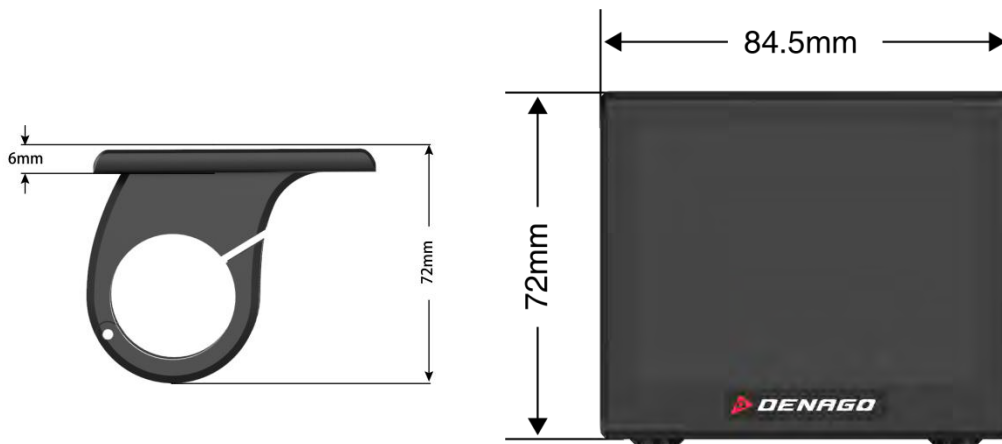

## 2. Function and Button Definition

### 2.1 Function description

K5242 provides you with a variety of function modes, to meet your riding needs.



Its functions are as follows:

- ◆ Battery power indication
- ◆ Speed indication
- ◆ Distance (including single trip distance and ODO display)
- ◆ Walk assist indication
- ◆ Backlight setting
- ◆ Error code indication
- ◆ Various setting parameters

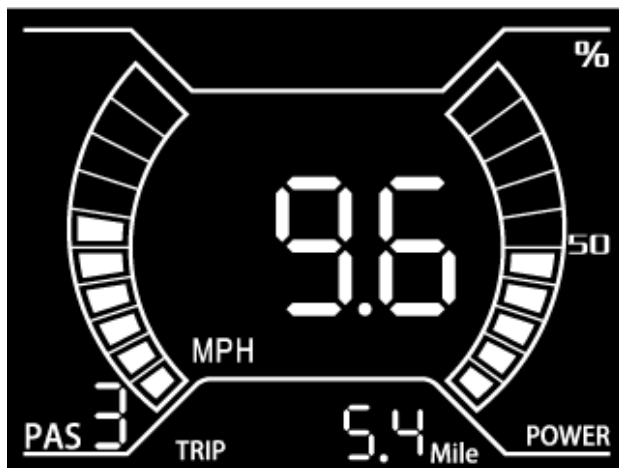
### 2.2 Normal Display Content



### 2.3 Button definition

There are 3 buttons on K5242-BLT, In the following introduction,  is named as “**MODE**”.  is named as “**UP**” and  is named as “**DOWN**”.

### 3. Note for Users

Be care of the safety use. Don't attempt to release the connector when battery is on power.



Try to avoid hitting.



Don't split the waterproof sticker to avoid affecting the waterproof performance.



Don't modify system parameters to avoid parameters disorder.



Make the display repaired when error code appears.

### 4. Installation Instruction

When the e-bike is powered off, you can insert the connector of display and the corresponding connector of controller to complete the installation, and adjust the display to a suitable angle.

### 5. User Settings

#### 5.1 On / Off

Long press "**MODE**" button then the display will work normally, and the controller will power on at the same time.

With the display on, long press "**MODE**" button, the display will shut down, the display will leave off battery, the leakage current of display on is less than 1 $\mu$ A.



## 5.2 User interface



## 5.3 Walk Assist Mode

Press and hold the “**DOWN**” button for 2 seconds to enter the Walk assist mode. The E-bike will travel at a constant speed of 6km/h.

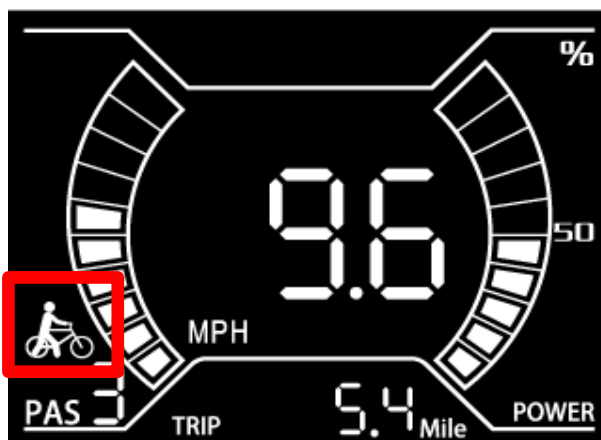

Walk assist mode interface

 **Walk Assist function can only be used as pushing the e-bike by hands. Please don't use this function when riding.**

### 5.4 PAS Level Selection

Short press the "UP" or "DOWN" button to switch the PAS level in the main interface, the motor output power will be changed accordingly by the PAS level of E-bike. The default range of PAS level is 0-5 levels. Level 1 is the lowest output level, and the level 5 is the highest output power level of the motor.

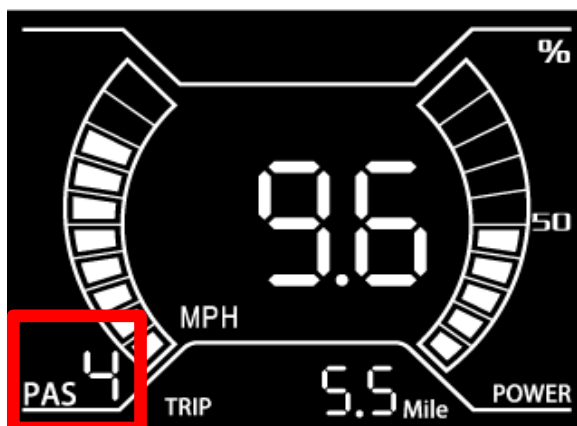

PAS level indicator

### 5.5 Battery Indicator

The battery power is shown as a percentage bar. When the battery is fully charged, the power bar shows 100%, each grid represents 10% Battery power.



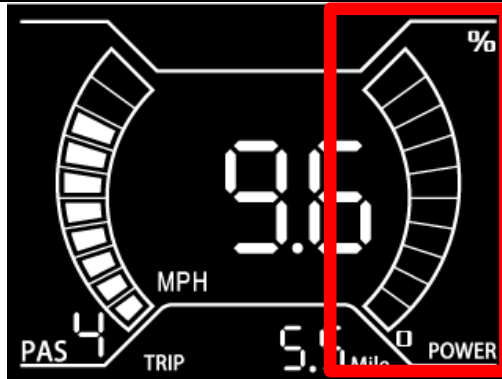

0% Battery indicator

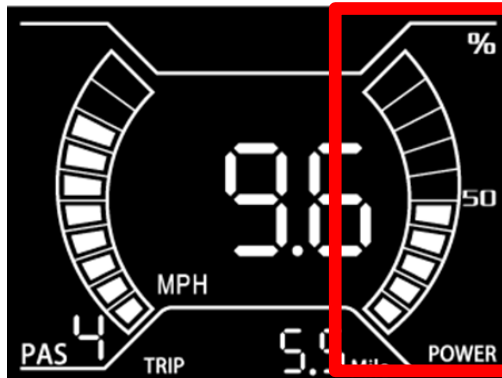

50% Battery indicator

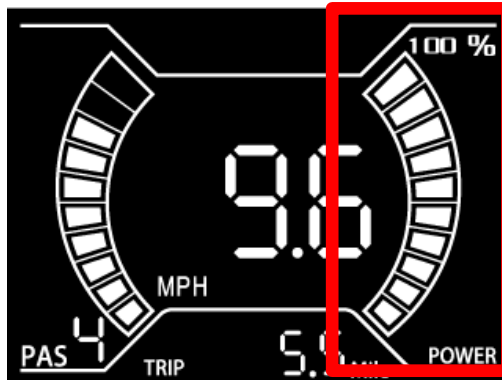

100% Battery indicator

## 5.6 Speed/Single Trip/Odometer

### 5.6.1 Real time speed, Trip display interface

When display is powered on, it shows the real-time speed and single trip mileage interface by default. When the speed is zero, long press "MODE" and "DOWN" button for 2 seconds, and the current single trip mileage will be cleared. After the display is shut down and restarted, the single trip mileage will not be cleared.

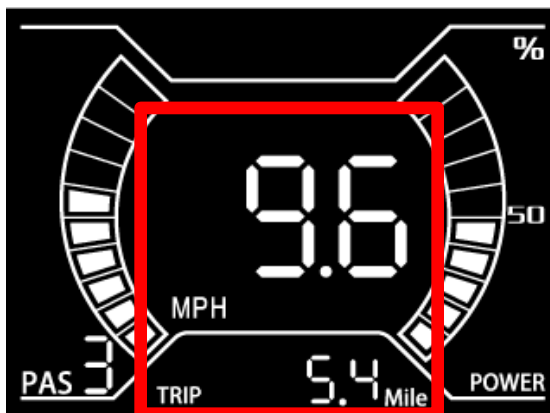

### 5.6.2 Max Speed, Odometer display interface

When display is powered on, short press "MODE" button in the normal interface to switch the Max speed and Odometer mileage data. The Max speed represents the maximum speed during this ride, and the Odometer mileage is the total mileage of the E-bike.

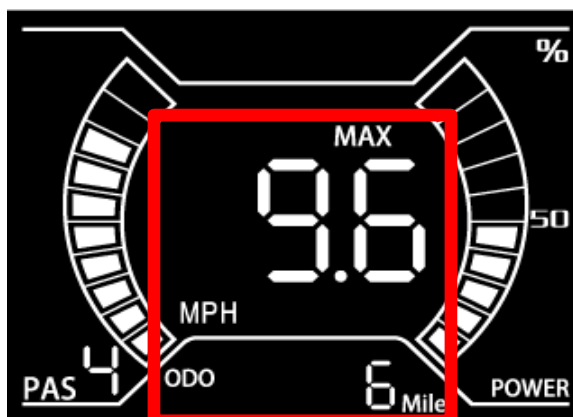

### 5.6.3 Avg Speed, To Go display interface

Short press "MODE" button again to switch to the Avg speed and To Go mileage display interface. The Avg speed represents the average speed during this ride, and the To Go mileage represents the remaining mileage that the E-bike can go.

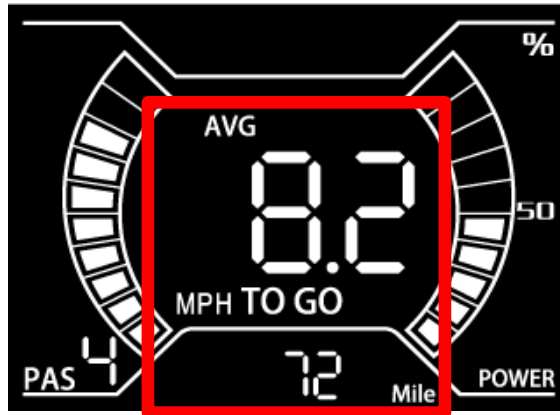

## 5.7 Error Code

When the e-bike electronic control system fails, the display will automatically indicate the error code. For the definition of detailed error codes, see appendix 1.

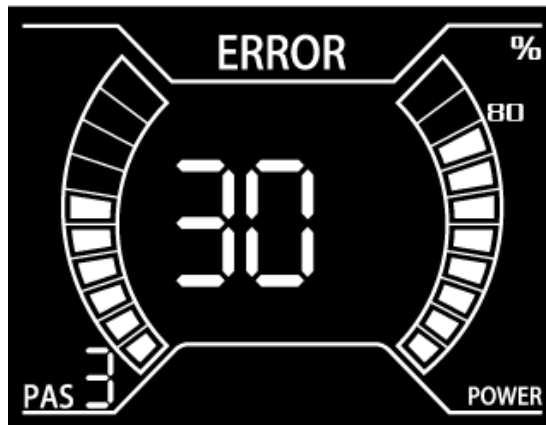

The fault can only be exited when the fault is eliminated, and the E-bike cannot continue to drive after a fault occurs.

## 6. User Settings

When there is no speed in the power on state, press and hold the "UP" and "DOWN" button at the same time for 2 seconds, and the display will enter the setting interface.

## 6.1 Wheel Size Setting

When enter the wheel size setting option. The settable values are: 16, 18, 20, 22, 24, 26, 700C, 27.5, and 28 inch. Select the corresponding wheel diameter of the E-bike through “UP” and “DOWN” button to ensure the accuracy of the speed display and mileage display. Long press “MODE” button to return to the normal interface.



## 6.2 Speed Limit Setting

Short press “MODE” button enter the speed limit setting option. The optional range of the maximum speed setting is 17Km/h to 45Km/h (11MPH to 28 MPH). It can be set by “UP” and “DOWN” button. The default setting is 45Km/H (28MPH). Long press “MODE” button to return to the normal interface.



### 6.3 Backlight Brightness Setting

Short press “**MODE**” button to enter the backlight brightness setting option. The setting options: 1, 2 and 3 indicates the backlight brightness, 1 is the darkest, 2 is standard brightness, 3 is the brightest. The default value is 3. Long press “**MODE**” button to return to the normal interface.

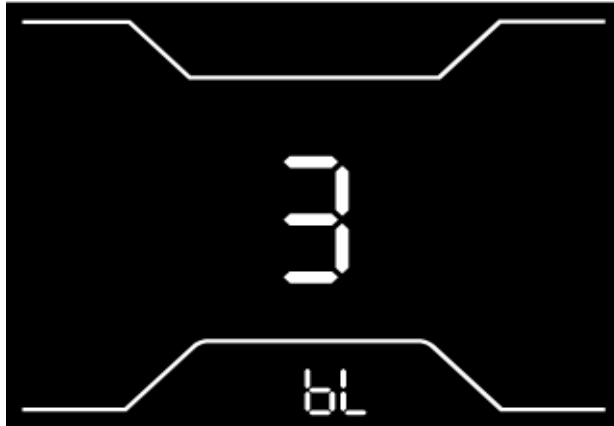

### 6.4 Display Unit Setting

Short press “**MODE**” button to enter the Unit setting option. The setting parameters are Km/h and Mile/h. Km/h or Mile/h can be selected by pressing “**UP**” and “**DOWN**” button. Km/h means the unit is metric system, and MPH means the unit is Imperial system. The default setting is MPH. Long press “**MODE**” button to return to the normal interface.

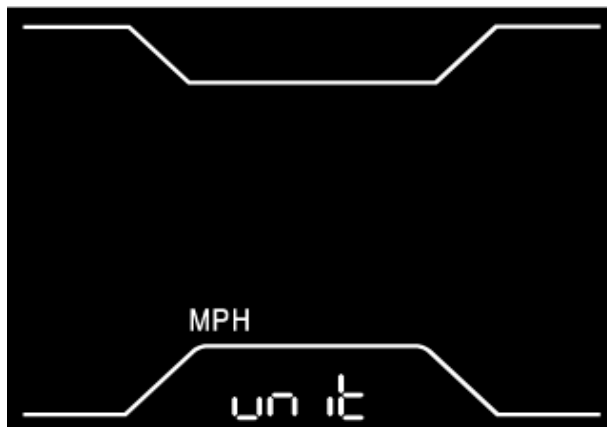

## 7. Preparation Before Startup

Please read the instruction carefully before using the display.

## 8. FAQ

Q: Why can't turn on the display?

A: Please check whether the battery is turned on or the leakage lead wire is broken

Q: How to deal with the error code display?

A: Contact the e-bike maintenance station in time.

## 9. Quality Assurance and Warranty Scope

I, Warranty Information:

1, King-Meter will be responsible for all faults arising during normal operation that are caused by a quality defect.

2, The warranty time is 24 months from the day the display leaves the factory.

II, The following are not covered by warranty:

1, Shell opened.

2, Connector damaged.

3, After display out of factory, the shell is scratched or damaged.

4, Lead wire of display scratch or break.

5, The fault or damage is caused by the force majeure (such as fire, earthquake, etc.) or natural disasters (such as lightning, flooding, etc.)

6, Product exceeded warranty period.

**Appendix 1: Error Code Definition**

Error Code	Definition	Solution
21	Current Abnormal	Check whether the three phase wires of the motor are short-circuited
22	Throttle Abnormal	Check whether the throttle is restored to the initial state
23	Motor phase problem	Check whether the phase wires are in good condition; Check whether the motor phase line is well connected to the controller
24	Motor Hall defect	No Hall controller: check whether the phase wire is in good condition With Hall controller: check whether the Hall outlet is good
25	Brake Failed	Check whether the brake lever is reset before power on.
30	Communication failure	Check whether the connection between display and controller is good



CITY MODEL 10 Monitor/Display made by King Meter (K5242)

---