

JustiFix® II JK

SICHERHEIT IM HOLZBAU GARANTIERT AUSSERGEWÖHNLICHES

MA Nr. 38483/20/1

SIHGA APP
GET IT ON Google Play
Download on the App Store



TAKE THE BEST

SIHGA GmbH | 4694 Ohlsdorf bei Gmunden | AUSTRIA
Tel.: +43 (0) 7612 - 74 370 - 0 | Fax DW 10 | E-Mail: info@sihga.com | www.sihga.com

JustiFix® II JK



JustiFix® JK 50 H

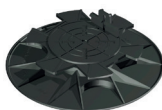

JustiFix® II JK 50 S

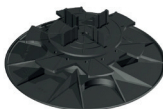

JustiFix® II JK 50

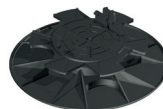

A 1 JustiFix® JK 50 H / II JK 50S / II JK 50



=



JustiFix® II JK
90 H/125 H / 160 H

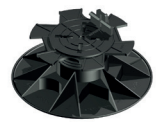

JustiFix® II JK
90 S/125 S/160 S

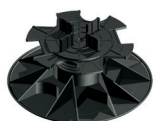

JustiFix® II JK
90/125/160

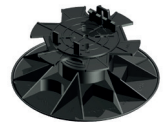

JustiFix® JA 70



B 1 JustiFix® II JK H / JK S / JK



=



von

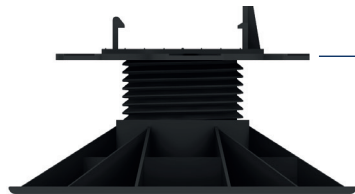

bis

Dimension JustiFix® II JK	Justierbereich		Auflagefläche Durchmesser
	von	bis	
Type	[mm]		[mm]
50	30	50	210
90	50	90	210
125	50	125	210
160	120	160	210

A/B 2

JustiFix® II JK

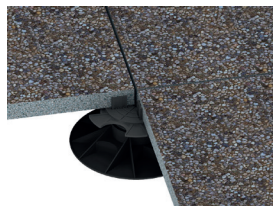

JustiFix® II JK H



JustiFix® II JK



C 1



C 2

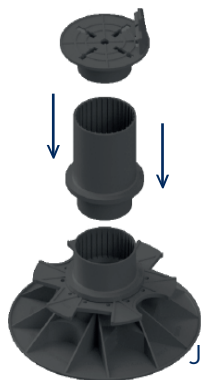

JustiFix® JA 70

JustiFix® II JK 125

C 3

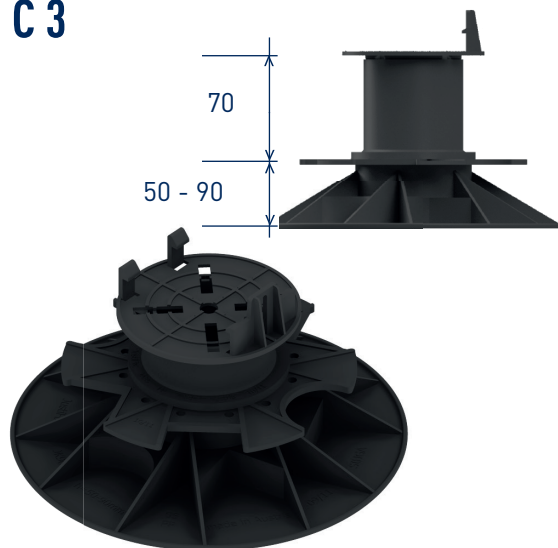

C 4

