



CADENCE



xenith

XAM Series Ultra Compact Full Range Digital Amplifiers // Owners Manual

TABLE OF CONTENTS

XAM600.1 Amplifier feature descriptions -----	Page 2
XAM400.2 Amplifier feature descriptions -----	Page 3
XAM500.4 Amplifier feature descriptions -----	Page 4
XAM500.4BT Amplifier feature descriptions -----	Page 5
XAM600.1 Mono block amplifier applications -----	Page 6
XAM400.2 2 Channel amplifier applications -----	Page 7
XAM500.4 4 Channel amplifier applications -----	Page 8
XAM500.4BT 4 Channel amplifier applications -----	Page 9
XAM Series amplifier features -----	Page 10
XAM600.1/XAM400.2/XAM500.4/XAM500.4BT Amplifier applications -----	Page 11
Troubleshooting -----	Page 12

INTRODUCTION

Thank you for purchasing this Cadence XAM Series amplifier. Over the years, the technology used to create audio amplifiers has grown by leaps and bounds. We have tens of thousands of satisfied customers still using our first generation Ultra Drive amplifiers which are more than 16 years old. We consider it our mission to use our expertise in developing the latest technologies and to bring you the absolute best sounding, most powerful amplifiers on the market and of course at a reasonable price. You will be amazed at the quality and power that these new amps offer.

Please read this installation guide carefully for proper use of your Cadence power amplifier. Should you need technical assistance during or after your installation please call our technical-line between 9:30 am and 5:00 PM PST at (626) 465-3383. Read this entire guide fully before attempting your installation.

When installing the amplifier, secure it tightly. An unmounted amplifier in your car can cause serious injury to passengers and damage to your vehicle if it is set in motion by an abrupt driving maneuver or short stop.

AMPLIFIER FEATURE DESCRIPTIONS

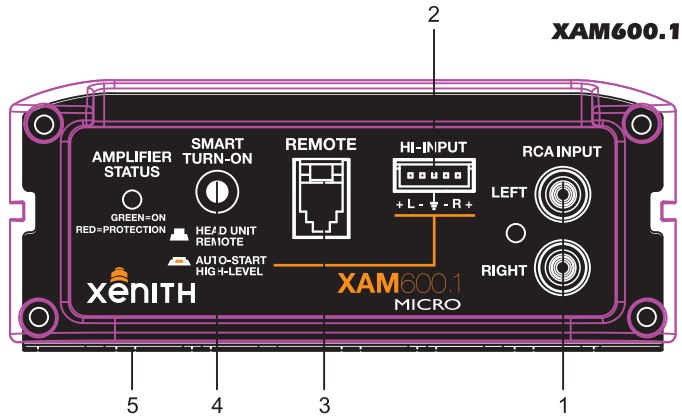

XAM600.1

- 1.Line Input RCA Jacks: These inputs are for signal cables from the source.
- 2.High Level Input: If your head unit does not have RCA outputs, use the speaker outputs for the audio source.
- 3.Remote Bass Control: Remote controls the subwoofer level.
- 4.Smart Turn On: Turn on by headunit remote or high level input auto start.
- 5.Power & Protection Indicators: The bi-color LED glows green when power is on and no problems are present. If one of the protection circuits comes on, it will change to red.

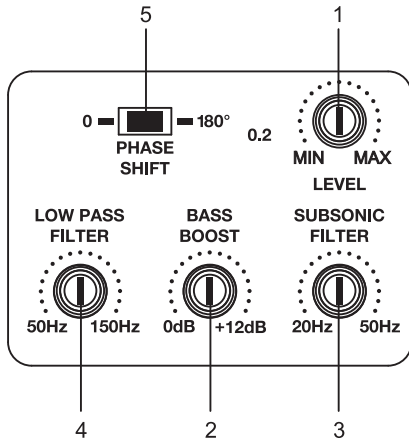

- 1.Input Level Control: Enables the matching of input levels to the output levels from the source.
- 2.Variable Bass Boost: 0~12dB
- 3.Subsonic: This setting acts as a low frequency cut off for your subwoofer. The subwoofer will not play frequencies below the subsonic setting.
- 4.Low Pass Filter: Variable from 50Hz to 150Hz
- 5.Phase Switch: 0°or 180°

AMPLIFIER FEATURE DESCRIPTIONS

XAM400.2

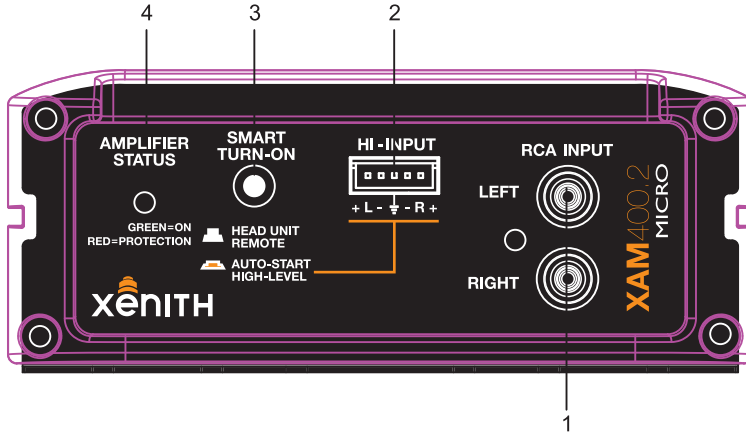

- 1.Line Input RCA Jacks: These inputs are for signal cables from the source.
- 2.High Level Input: If your head unit does not have RCA outputs, use the speaker outputs for the audio source.
- 3.Smart Turn On: Turn on by headunit remote or high level input auto start.
- 4.Power & Protection Indicators: The bi-color LED glows green when power is on and no problems are present. If one of the protection circuits comes on, it will change to red.

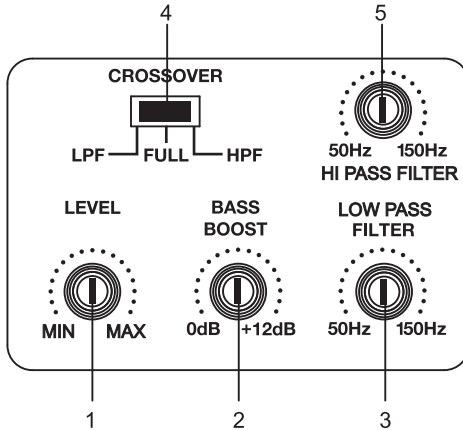

- 1.Input Level Control: Enables the matching of input levels to the output levels from the source.
- 2.Variable Bass Boost: 0~12dB
- 3.Low Pass Filter: Variable from 50Hz to 150Hz
- 4.Crossover Mode: Low pass, Full range or High pass
- 5.High Pass Filter: Variable from 50Hz to 150Hz

AMPLIFIER FEATURE DESCRIPTIONS

XAM500.4

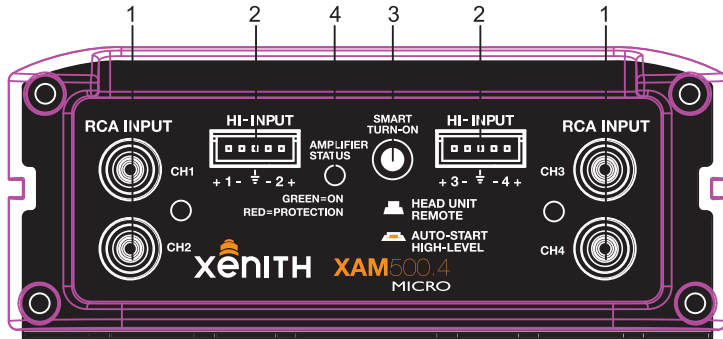

1. Line Input RCA Jacks: These inputs are for signal cables from the source.
2. High Level Input: If your head unit does not have RCA outputs, use the speaker outputs for the audio source.
3. Smart Turn On: Turn on by headunit remote or high level input auto start.
4. Power & Protection Indicators: The bi-color LED glows green when power is on and no problems are present. If one of the protection circuits comes on, it will change to red.

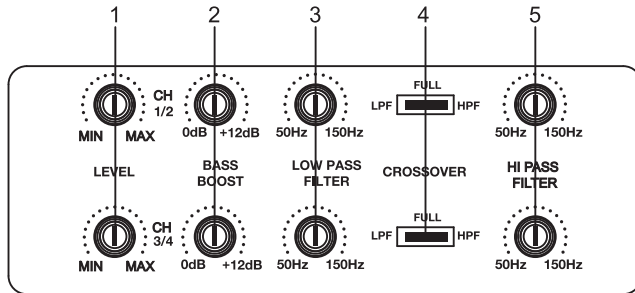

1. Input Level Control: Enables the matching of input levels to the output levels from the source.
2. Variable Bass Boost: 0~12dB
3. Low Pass Filter: Variable from 50Hz to 150Hz
4. Crossover Mode: Low pass, Full range or High pass
5. High Pass Filter: Variable from 50Hz to 150Hz

AMPLIFIER FEATURE DESCRIPTIONS

XAM500.4BT

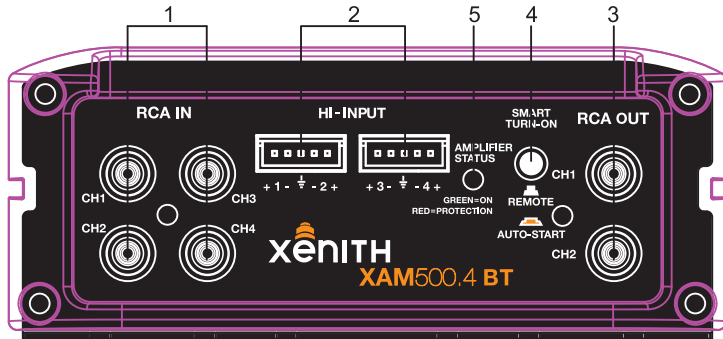

1. Line Input RCA Jacks: These inputs are for signal cables from the source.
2. High Level Input: If your head unit does not have RCA outputs, use the speaker outputs for the audio source.
3. Output RCA Jacks: To audio Inputs of satellite amplifier(if present).
4. Smart Turn On: Turn on by headunit remote or high level input auto start.
5. Power & Protection Indicators: The bi-color LED glows green when power is on and no problems are present. If one of the protection circuits comes on, it will change to red.

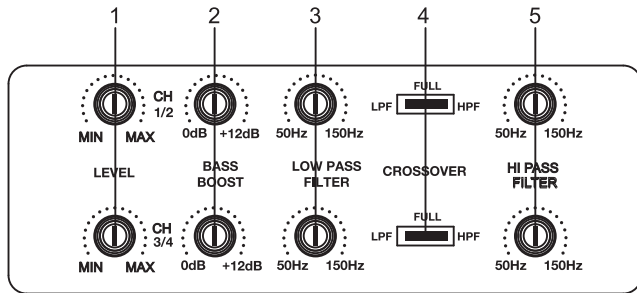

1. Input Level Control: Enables the matching of input levels to the output levels from the source.
2. Variable Bass Boost: 0~12dB
3. Low Pass Filter: Variable from 50Hz to 150Hz
4. Crossover Mode: Low pass, Full range or High pass
5. High Pass Filter: Variable from 50Hz to 150Hz

6. Bluetooth:

- * Surface Mounted Antenna for Superb Range and Strength
- * Bluetooth Password: "5004"

7. Controlled feature via handset Bluetooth connection:

- * "Pause" & "Play"
- * Music "Next" & "Previous" selection
- * Volume controller "Up" & "Down"

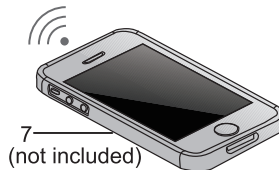

XAM600.1 MONO BLOCK AMPLIFIER APPLICATIONS

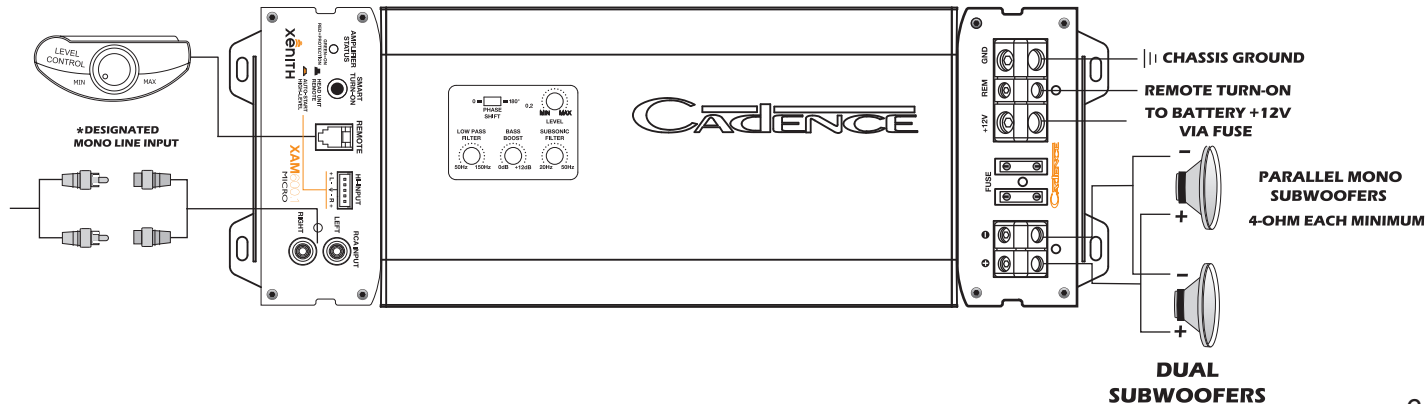
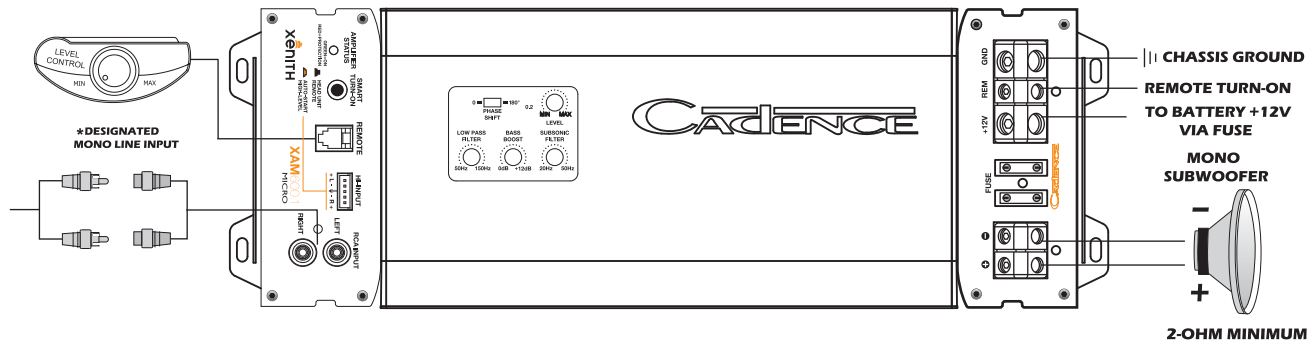

XAM400.2 2 CHANNEL AMPLIFIER APPLICATIONS

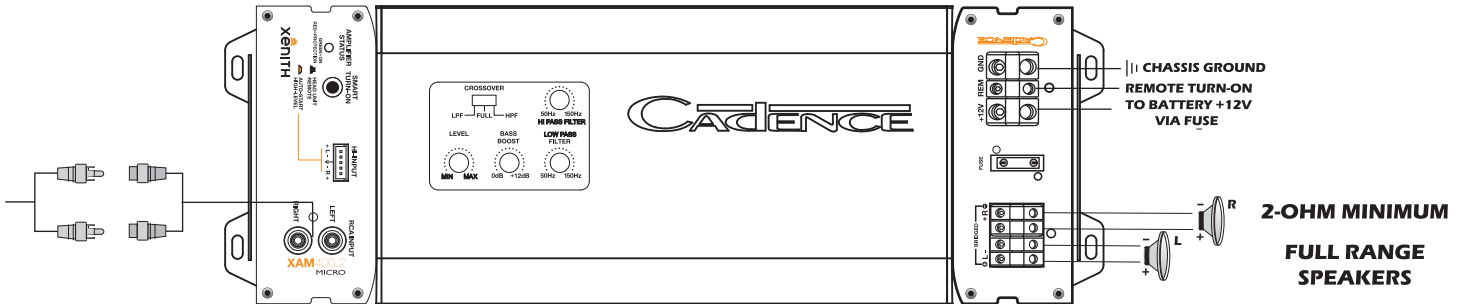
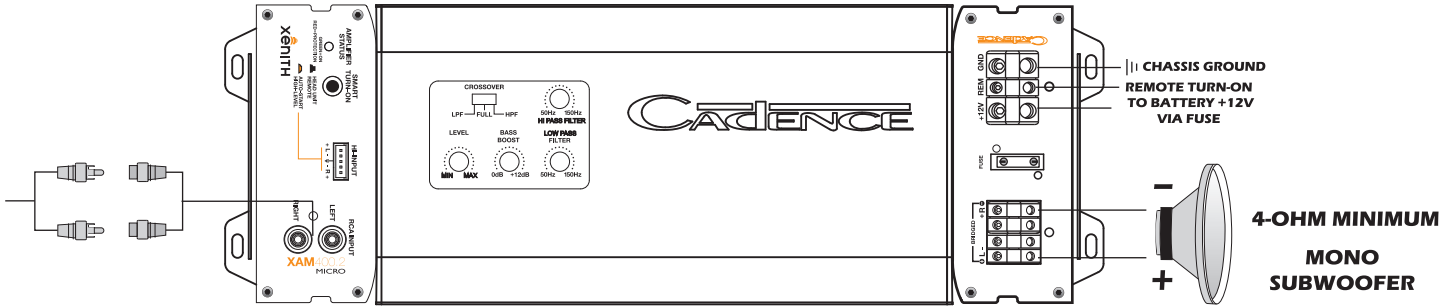

XAM500.4 4 CHANNEL AMPLIFIER APPLICATIONS

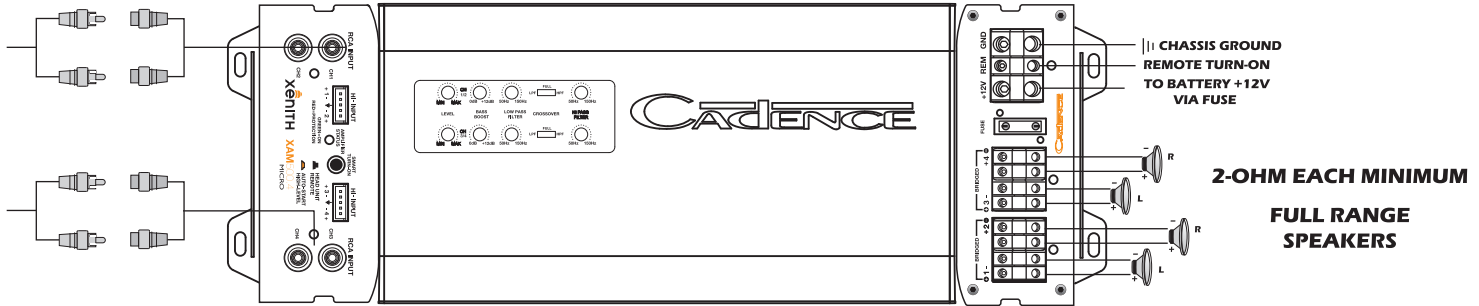
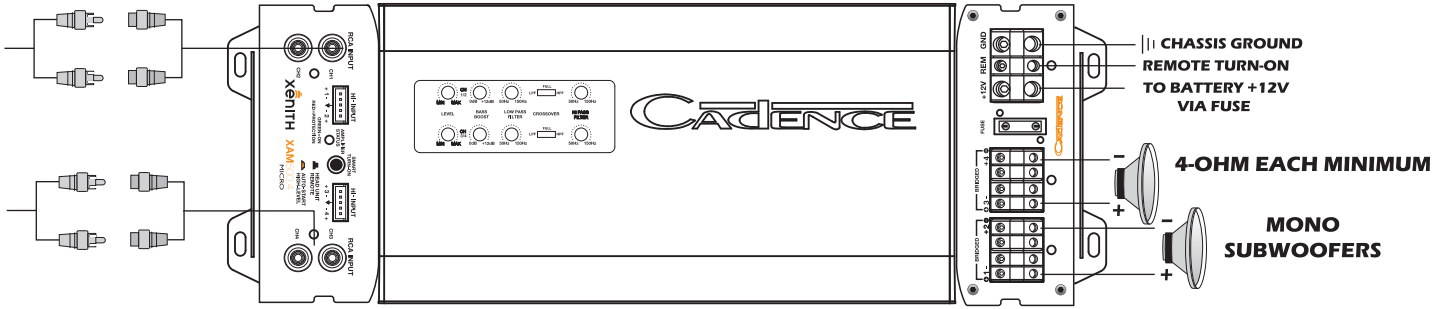

XAM500.4BT 4 CHANNEL AMPLIFIER WITH BLUETOOTH APPLICATIONS

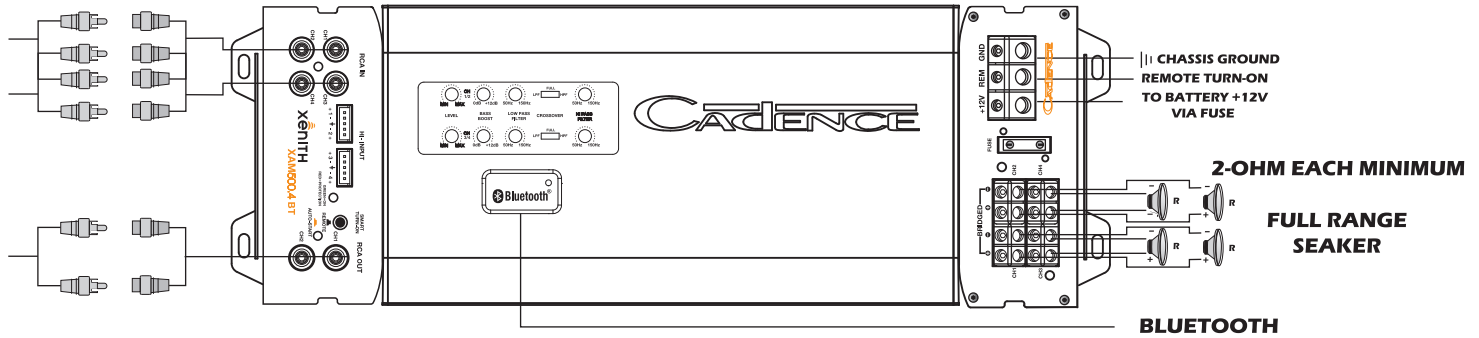
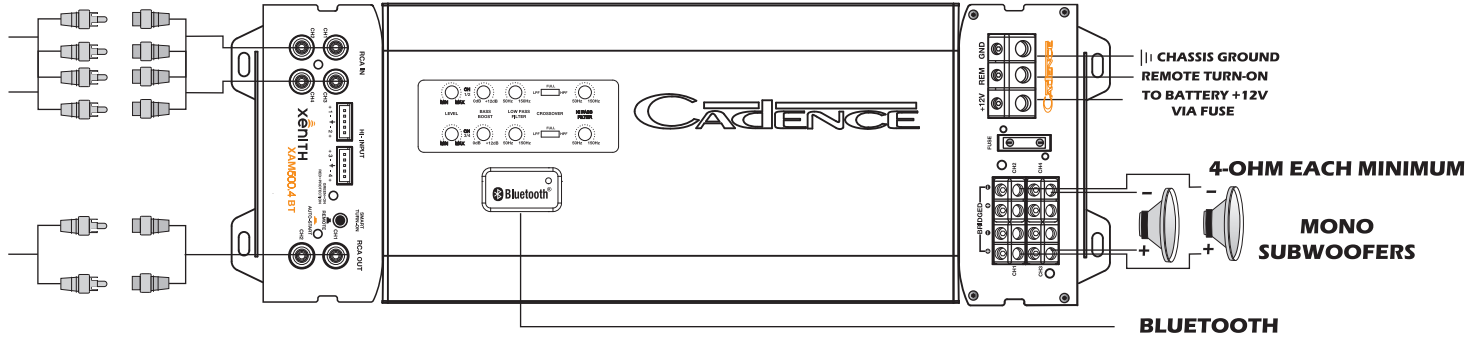

XAM SERIES AMPLIFIER FEATURES

MODEL	XAM600.1	XAM400.2	XAM500.4	XAM500.4BT
Output Power Rating				
RMS @ 4 OHM	300W x 1	125W x 2	90W x 4	90W x 4
RMS @ 2 OHM	600W x 1	200W x 2	125W x 4	125W x 4
RMS @ 4 OHM Bridged	N/A	400W x 1	250W x 2	250W x 2
RCA Low Level Input	Yes	Yes	Yes	Yes
High Level Input	Yes	Yes	Yes	Yes
Green & Red Power Status Indicators	Yes	Yes	Yes	Yes
Phase Switch	0 or 180°	N/A	N/A	N/A
Adjustable Input Sensitivity	Yes	Yes	Yes	Yes
Variable Bass Boost	0 to +12dB@45Hz	0 to +12dB@45Hz	0 to +12dB@45Hz	0 to +12dB@45Hz
Crossover Mode	Low Pass	Low Pass / Full / High Pass	Low Pass / Full / High Pass	Low Pass / Full / High Pass
Low Pass Filter	50-150Hz	50-150Hz	50-150Hz	50-150Hz
Subsonic Filter	20-50Hz	N/A	N/A	N/A
High Pass Filter	N/A	50-150Hz	50-150Hz	50-150Hz
Subwoofer Gain Remote Control	Yes	N/A	N/A	N/A
Hi-Level Signal Auto Turn-on /off	Yes	Yes	Yes	Yes
Thermal, Short and Overload Protection Circuits	Yes	Yes	Yes	Yes
Soft Delay Remote Turn-On	Yes	Yes	Yes	Yes
RCA Output	N/A	N/A	N/A	Yes
Bluetooth	N/A	N/A	N/A	Yes
Fuse Rating	2×25A	1×40A	1×40A	1×40A
Dimensions	11.18"(L) x 5"(W) x2"(H)	11.18"(L) x 5"(W) x2"(H)	12.91"(L) x 5"(W) x2"(H)	12.91"(L) x 5"(W) x2"(H)

XAM600.1/ XAM400.2/XAM500.4 /XAM500.4BT AMPLIFIER APPLICATIONS

General:

At this point you are ready to get more specific on the settings for your amplifier.

Subsonic:

This setting acts as a low frequency cut off for your system bass reproduction. The point that you set it at cuts off any frequencies from reproduction beyond this point. The 12 o'clock position is a great starting point. EXAMPLE: If you adjust the Subsonic to 25Hz, the amplifier will not play frequencies below 25Hz but will play frequencies from 25Hz to the chosen Low Pass frequency.

Bass EQ:

This setting is a fixed bass boost at 45Hz that is variable from 0-12dB. This feature provides impact to your bass, but if not adjusted correctly, it can be over used and cause damage to your subwoofers and amplifiers. It is best to slowly turn this setting clockwise until the desired punch is felt, it is not recommended to exceed the 12 o'clock position unless listening at a low volume or a low recording quality as this can result in high distortion and possibly clipping.

Low Pass:

The Low pass control acts as a ceiling and doesn't allow frequencies to the right of the desired setting to be reproduced. The 12 o'clock position is a great starting point. EXAMPLE: If you adjust the Low Pass to 80Hz, the amplifier will not play frequencies above 80Hz but will play frequencies from 80Hz to the chosen Subsonic frequency.

Phase:

The phase switch allows you to change the phase of your subwoofer so that it best blends with your component speakers. While listening to a song with strong bass material set the switch to the position that gives the best blending of the subwoofers and component speakers.

High Pass:

When in Hi Pass operation this setting acts as a low frequency cut off your system reproduction. The point that you set it at cuts off any frequencies from reproduction beyond this point. The 12 o'clock position is a great starting point. EXAMPLE: If you adjust the High Pass to 100Hz ,the amplifier will not play frequencies below 100Hz but will play frequencies from 100Hz to the chosen Low Pass frequency.

Level (GAIN) Control Setup:

Ensure that the level is turned completely to the left prior to turning the system on. Next you should insert a CD or cassette that you are familiar with to use as a reference, and turn the head unit volume control to about 80% of its full setting. The system sound level will of course be very low, and the following procedures will help you to match the amplifier input sensitivities properly to the head unit output signal level. It is important to match the amplifier LEVEL input sensitivity to the Radio/CD output sensitivity. This can be located in the Radio/CD manual. If the Radio/CD output sensitivity is 2 volts, then adjust the amplifier LEVEL input to 2 volts.

If you are not sure what the Radio output sensitivity is, follow these general guide lines:

Turn the level control up slowly, till you hear distortion, then back off a few degrees on the control, If at any point your amplifier goes into protection. you will need to turn the Level to the left a bit and then try again. If you reach a point where the output does not increase, stop turning the Level control to the right as the amplifier/subwoofer combo has reached its max output on this application.

TROUBLESHOOTING

Before removing your amplifier, refer to the list below and follow the suggested procedures. Always test the speakers and their wires first.

AMPLIFIER WILL NOT POWER UP.

- Check for good ground connection.
- Check that remote DC terminal has at least 13.8v DC.
- Check that there is battery power on the + terminal.
- Check all fuses.
- Check that protection LED is not lit, If it is lit, shut off amplifier briefly and then repower it.

HIGH HISS OR ENGINE NOISE (ALTERNATOR WHINE) IN SPEAKERS.

Disconnect all RCA inputs to the amplifier(s)-if hiss/noise disappears, then plug in the component driving the amplifier and unplug its inputs. If hiss/noise disappears, go on until the faulty/noisy component is found.

It is best to set the amplifier's input level as insensitive as possible. The best subjective S/N ratio is obtainable this way. Try to drive as high a signal level from the head unit as possible.

PROTECTION LED COMES ON WHEN THE AMPLIFIER IS POWERED UP.

- Check for shorts on speaker leads.
- Check that the volume control on the head unit is turned down low.
- Remove speaker leads, and reset the amplifier. If the Protection LED still comes on, then the amplifier is faulty.

AMPLIFIER(S) GETS VERY HOT:

- Check that the minimum speaker impedance for that model is correct.
- Check for speaker shorts.
- Check that there is good airflow around the amplifier. In some applications, an external cooling fan may be required.

DISTORTED SOUND

- Check that the Level control(S) is set to match the signal level of the head unit.
- Check that all crossover frequencies have been properly set.
- Check for shorts on the speaker leads.

HIGH SQUEAL NOISE FROM SPEAKERS.

This is always caused by a poorly-grounded RCA patch cord.

// Features and specifications subject to change and or improvement without notice.
Though we tried our best to ensure that this manual is free and clear of errors please don't hold us responsible for printing errors. //

Copyright by Cadence Acoustics LTD.
www.cadencesound.com