

## 1. APPLICATION DESCRIPTION

In several industrial applications thin sheets need nuts to be welded to a hole to allow screws to be mounted. As those processes are almost fully automated there is a need for sensors to detect if a nut is indeed present before the screw is mounted.

As nuts are sometimes mounted on hardly accessible parts of a metallic sheet it is often needed to measure for the other side, through the metal sheet.

Contrinex full metal sensors provide a cost-effective and freely configurable solution for nut detections measuring through the sheet (Side where the screw will be mounted)

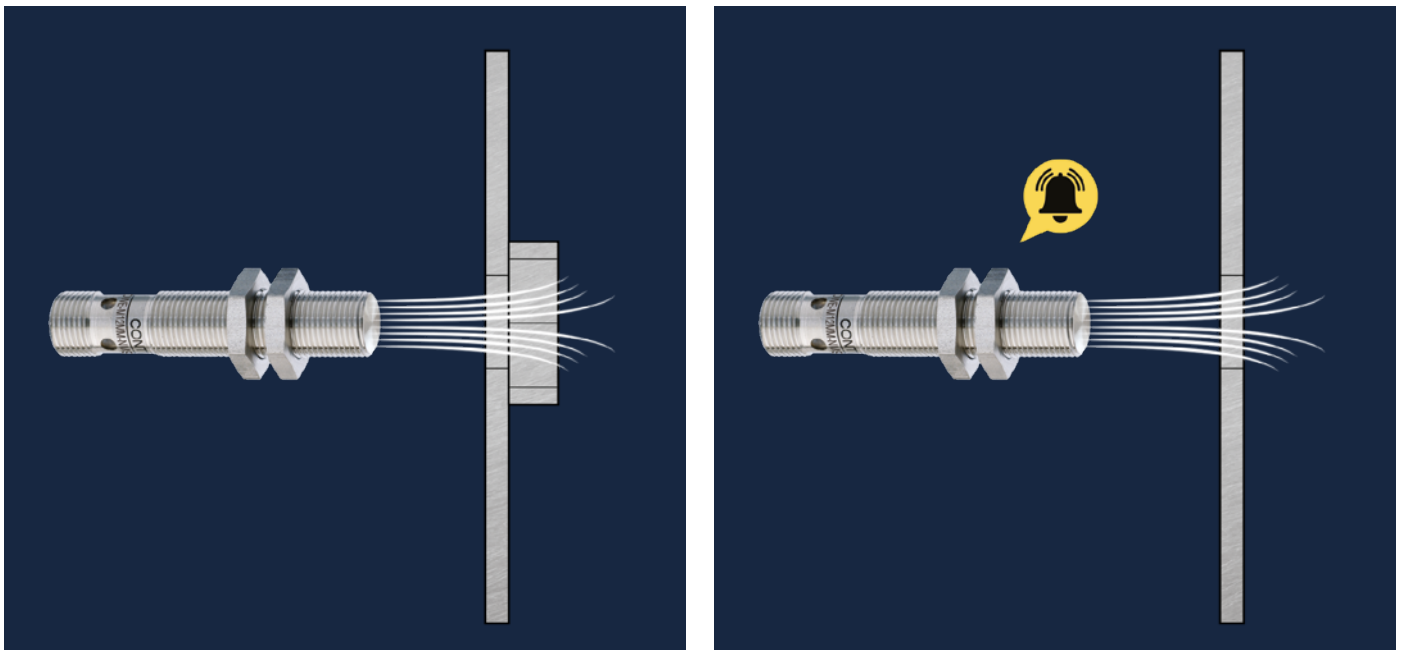

Contrinex smart sensors can utilize the distance measurement principle to determine the presence of the nut on the other side of the sheet. The presence of the nut causes results in a smaller distance measurement compared to a sheet without a nut. The configurable detection thresholds of Contrinex smart sensors allow for the detection of various sheet thickness, nut sizes and materials.

Applications where the nut is fixated on the others side than the sensor and no hole is drilled in the sheet can also work but need more evaluation as the measurement drop will not be as pronounced as a sheet with the whole for a screw.

## 2. CONFIGURATIONS



### 2.1. IDWX-MXXMM-NMS-A0 NUT DETECTION CONFIGURATION

<https://app.pocketcodr.com/follow-config/b259911e-1eef-484c-bac0-415c71d11be3/>

### 3. CONTRINEX SMART SENSOR TYPE

Contrinex does recommend using inductive DMS smart sensors from the full metal family.

#### IDWE-MxxMM-NMS-A0

The full metal smart sensors suit best for this type of application due to their measuring technology which will detect better added material than the smart sensor with a plastic sensing face (detect better added surface).

The size of the sensors (M12 or M18) will depend on the target material, thickness of the sheet and the size of the nut. This needs to be determined by testing.

### 4. APPLICATION REQUIREMENTS

Any metallic nut can be detected with the inductive full metal smart sensors. Although to ensure a correct detection the following requirements need to be full filled.

Consistent positioning and distance to the target are required when approaching the sensor.

REQUIREMENT	MINIMUM RESULT	COMMENT
Distance measurement value of the sheet without the nut mounted	$\geq 20\%$	Increase distance between sensor and the sheet if the measurement is lower.
Measurement drop when adding the nut	$\geq 5\%$	Because of the minimum hysteresis width
Distance measurement value of the sheet with the nut	$\geq 15\%$	Increase the distance between the sensor and the sheet if the measurement is lower.
Hysteresis configuration for SSC2	$\geq 5\%$	Can be configured bigger depending on the application

#### 4.1. TARGETS

In this example the sheets are 1mm thick stainless-steel plates which have an 8.3mm diameter hole in the center.

The nut is a standard M8 nut with a thickness of 2.5 mm.



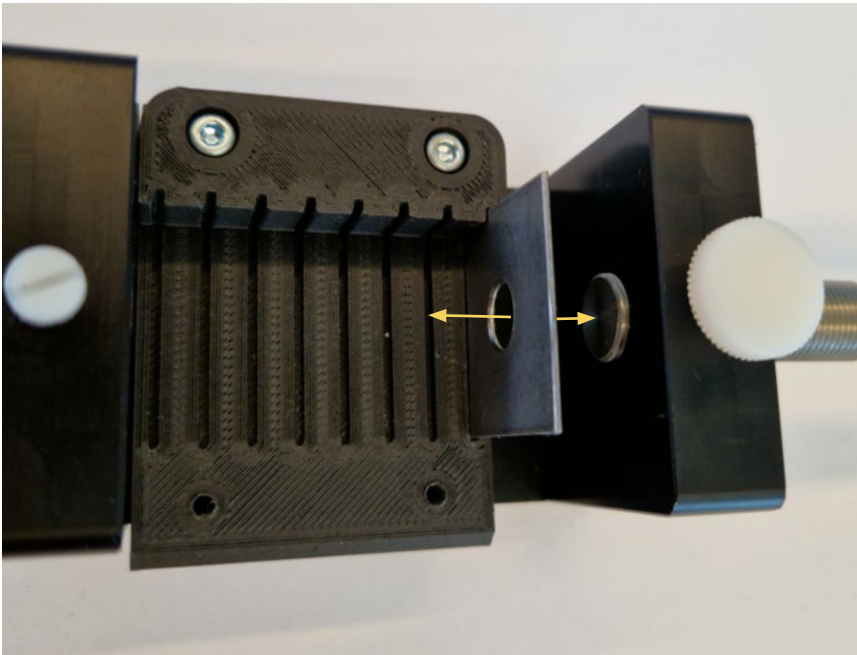

**4.2. APPROACHING THE SENSING FACE TO THE TARGET**

In order to achieve a stable reference point and ensure measurement repeatability, it is necessary to approach either the target or the sensor along the sensing axis. This approach should culminate in a consistent position and distance between the target and the sensor.

In the case the hole on the target is not centered in front of the sensor the measurement might trigger the detection point for a nut detection.

**4.3. MEASUREMENT OF A SHEET WITHOUT THE NUT**

It is important that the sheet without the nut does not saturate the measurement value beneath 20% to be able to latter on detect the case with a nut reliably.

**15% (not recommend area to set SSC's) + 5% (min recommended hysteresis width) = 20%**

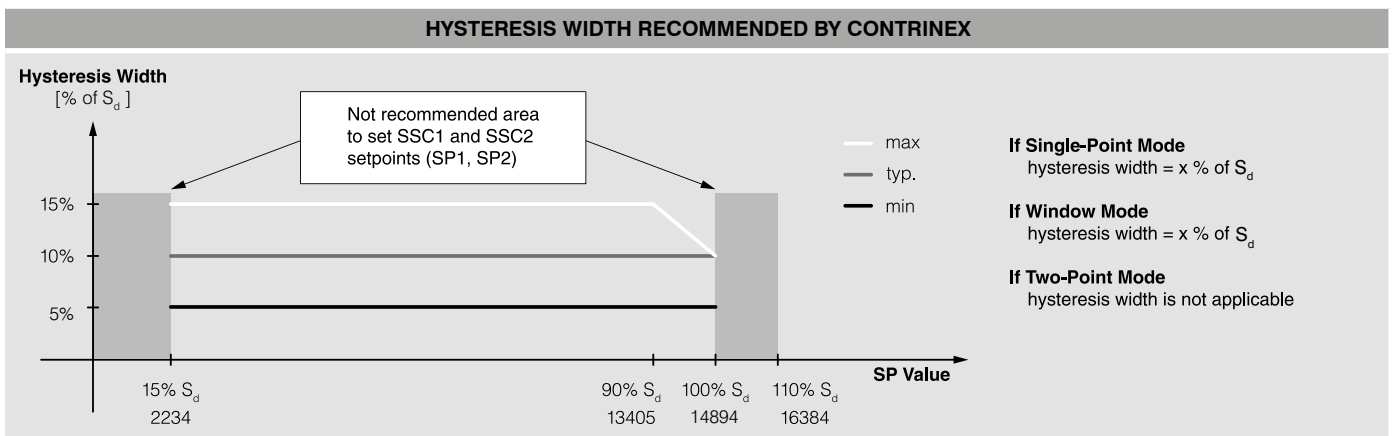

If the first sheet does bring down the measurement value beneath 20% increasing the distance between the sensor and the first sheet will resolve the issue.



#### 4.4. MEASUREMENT OF A SHEET WITH THE NUT

As it is not recommended to place switch points beneath 15% distance measurement the sheet with the nut must not be beneath 15% and be at least 5% lower than the measurement of the sheet without the nut.

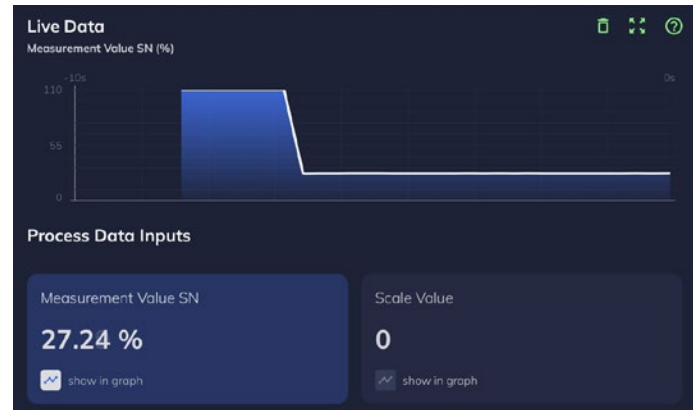

The user can configure the hysteresis with a bigger value than 5 % depending on the needs of the specific application.

## 5. CONFIGURATION DESCRIPTION

All configurations in the examples have been done with the PocketCodr app and the widgets available in the app.

With the link below the configuration examples can be linked to the PocketCodr account and synchronized to the wished device.

The switch points (SSC1 and SSC2) setpoints will need to be redefined for the respective application.

Recalibration to do on this configuration.

- Teach SSC1 (Single point) to detect the target sheet without the mounted nut.

It is recommended to teach the position of the sheet without the nut at the furthest possible distance to the sensor. This ensures a reliable first sheet detection.

- Teach SSC2 (Single point) to detect when sheet with a nut mounted on it is placed in front of the sensing face.

- It is recommended to teach the position of the sheet with the nut at the furthest possible distance to the sensor. This ensures a reliable nut detection.

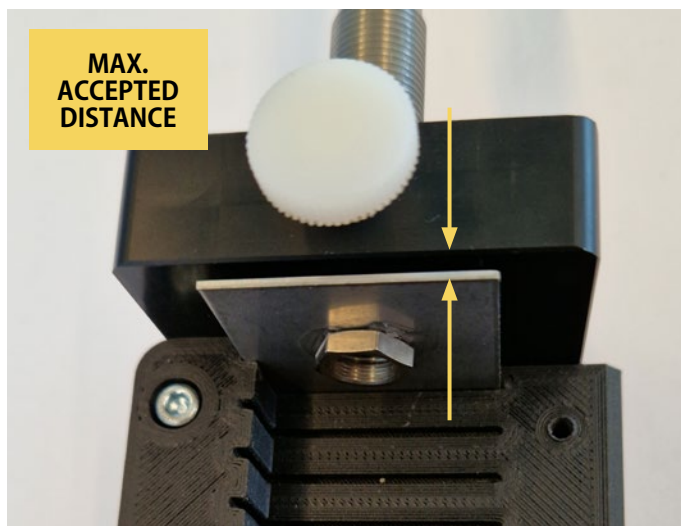
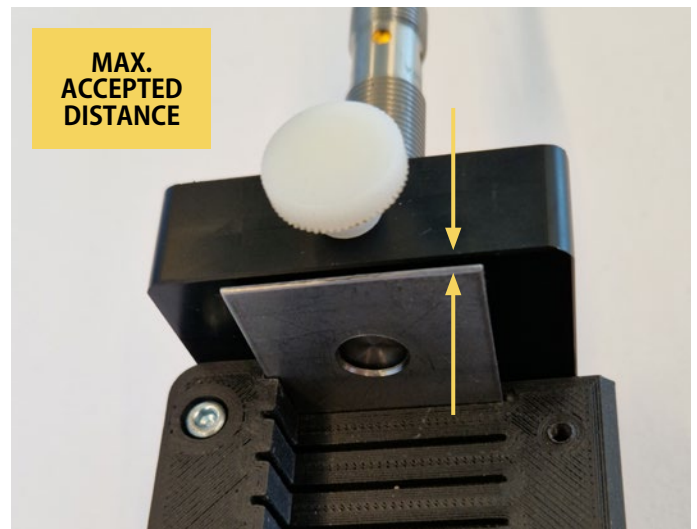

- The counter is configured to count the number of times a sheet with a nut has been detected.
- The outputs OSS1 is configured to signal the presence of a sheet in front of the sensor
- The output OSS2 is configured to signal the presence of a mounted nut on the other side of the sheet.

## 5.1. SSC1

SSC1 is configured in single point mode so it does switch on as soon as any sheet is detected (with and without a nut mounted).

To cater to the requirements of the application, it is necessary to adjust the setpoints of the system. This adjustment can be accomplished either by manually inputting the setpoint values or by utilizing a teaching procedure. By doing so, the SSC1 is configured only to detect when an actual sheet is present in front of the sensor. The user can change the setpoint and the hysteresis to adjust the sensibility of the sheet detection.



It is visible that the SSC1 switches on only when the predefined level is configured. This indicates that a sheet is present in front of the sensor.

## 5.2. SSC2

Switch point SSC2 is configured to detect only when there is a sheet with a mounted nut present in front of the sensor.

To do this SSC2 is configured in as single point detection configured with a lower threshold than SSC1.

SSC2 will identify excessive target material in front of the sensor, indicating the presence of a nut. The desired threshold can be programmed using any method, causing SSC2 to activate when additional material is detected. However, it is advised to position SSC2 5% closer to the sensor than SSC1, to prevent the hysteresis of SSC2 from approaching the detection point of SSC1 too closely.

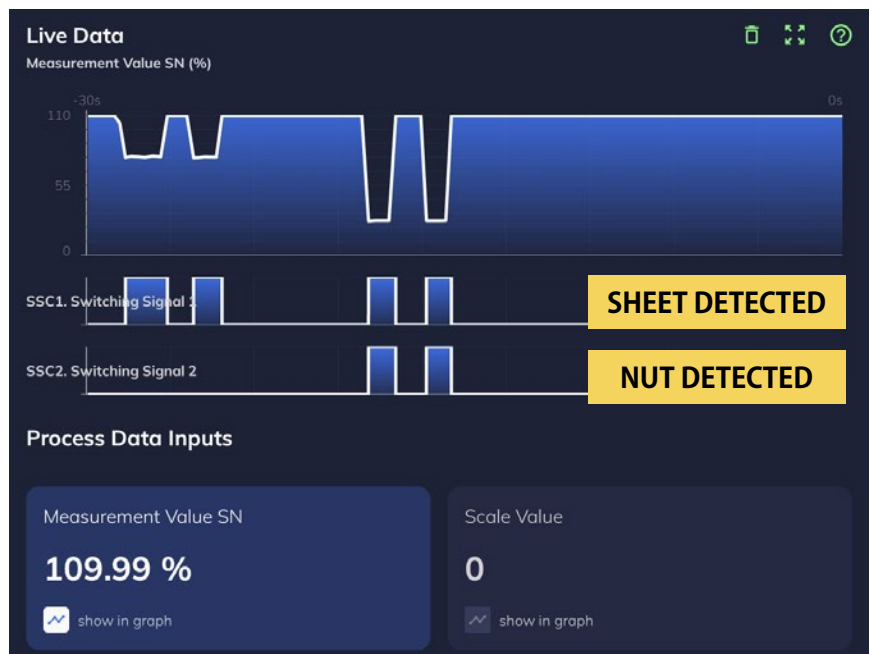

### 5.3. OUTPUT PIN 4 OSS1

The first output OSS1 will give the state of a sheet detection. It is configured to give an output signal when SSC1 did detect a sheet.

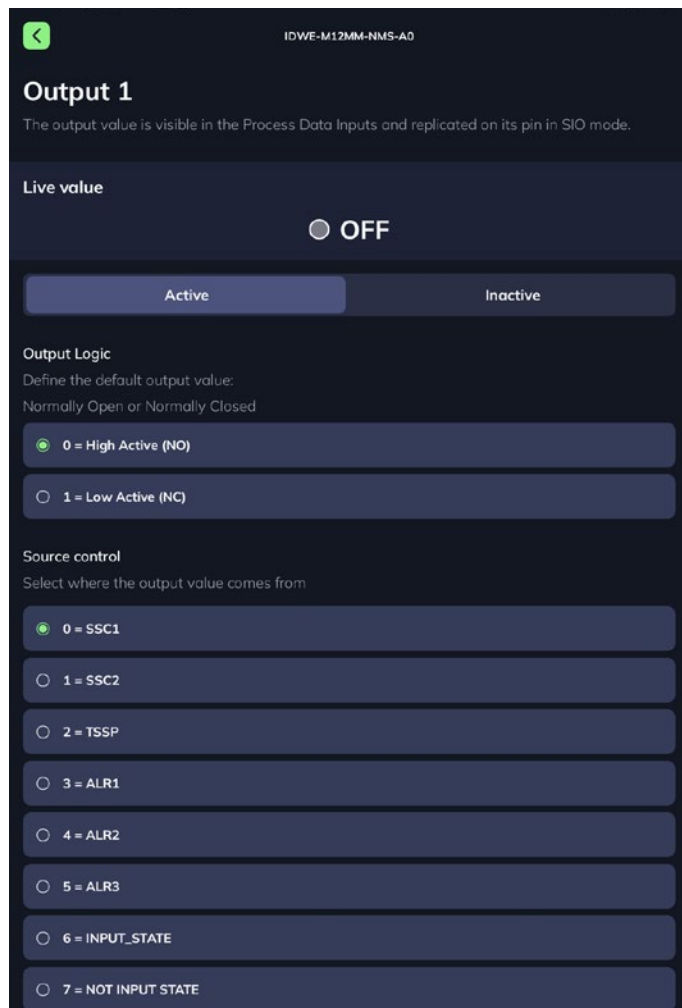

If IO-Link is used the user can read out the signal OSS1 through the process data.

### 5.4. OUTPUT PIN 2 OSS2

OSS2 is configured to switch on when SSC2 is triggered. This allows to give out a signal when a nut is detected.

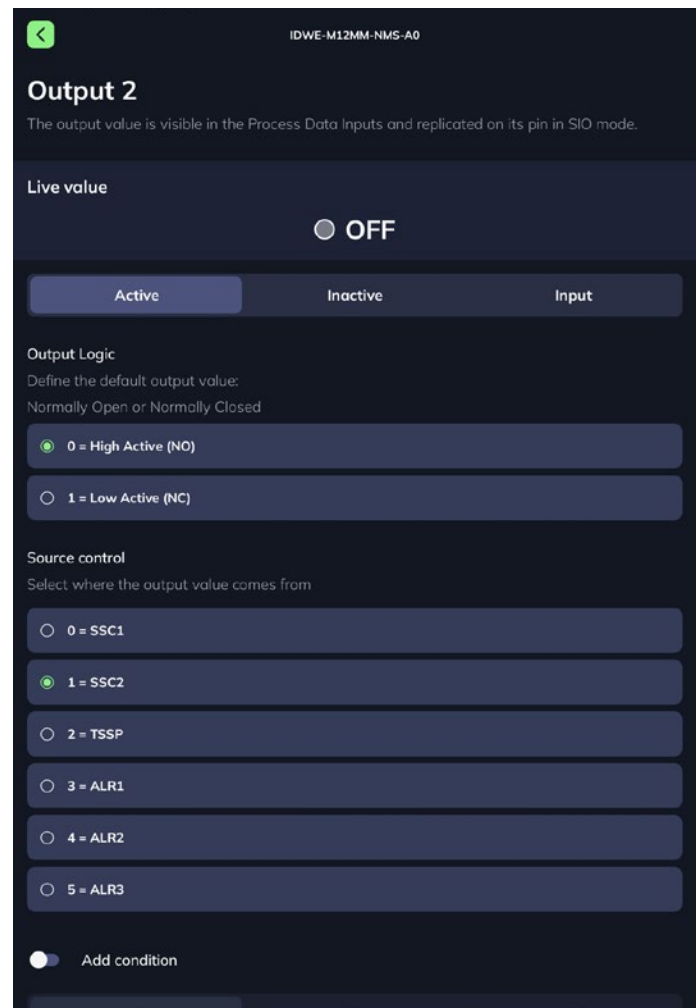

## 5.5. ADDITIONAL CONFIGURATIONS

Those additional configurations allow for more indicative data which can be read out of the sensor if needed. They do not alter anyhow the functioning of the nut detection.

### 5.5.1. COUNTER

In this configuration example the counter is set to count the number of times the sensor detected a nut on the application. For this the rising edge of the switch point SSC2 is counted.

This value can be read out through IO-Link or could be configured as the measurement value of the process data with the Sensor configuration unit (SCU) in the “all value” widget.

The counter can be reset to 0 by either one of the three alarms, by writing the counter index through IO-Link or with the available button in the PocketCodr app.

In this configuration example no Alarm has been activated and the reset of the value can be done on the PocketCodr counter widget.

