

MECHANICAL DATA

Self-adhesive	Yes
Material	PMMA
Temperature	-40 ...+70°C
Protection	IP67
Weight	9 g

AVAILABLE TYPES

Part number	Part reference
622 000 095	LXR-0000-046

Operators of the products we supply are responsible for compliance with measures for the protection of persons. The use of our equipment in applications where the safety of persons might be at risk is only authorized if the operator observes and implements separate, appropriate and necessary measures for the protection of persons and machines. Terms of delivery and rights to change design reserved.

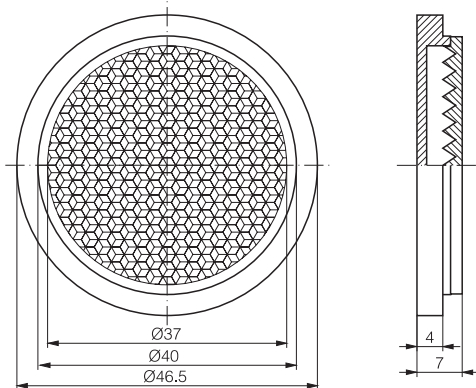
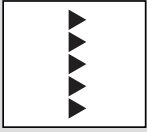

DONNÉES MÉCANIQUES

Autocollant	Oui
Matériau	PMMA
Température	-40 ...+70°C
Protection	IP67
Poids	9 g

MODÈLES DISPONIBLES

Numéro d'article	Désignation
622 000 095	LXR-0000-046

Les exploitants des produits que nous fournissons sont tenus d'assurer des mesures adéquates de protection des personnes. L'utilisation de nos appareils dans des applications comportant un risque possible pour la sécurité des personnes n'est admissible que si l'exploitant observe et met en œuvre des mesures séparées, appropriées et nécessaires pour la protection des personnes et des machines. Sous réserve de modifications et de possibilités de livraison.

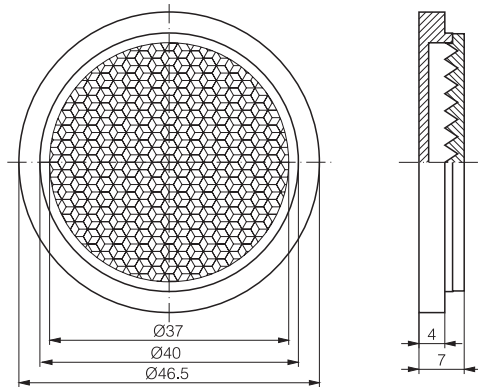
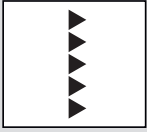

MECHANISCHE EIGENSCHAFTEN

Selbstklebend	Ja
Material	PMMA
Temperatur	-40 ...+70°C
Schutz	IP67
Gewicht	9 g

VERFÜGBARES PROGRAMM

Artikel Nummer	Bezeichnung
622 000 095	LXR-0000-046

Die Einhaltung der Personenschutzmaßnahmen obliegt dem Betreiber der von uns gelieferten Produkte. Der Einsatz unserer Geräte in Anwendungen, bei welchen die Sicherheit von Personen gefährdet sein könnte, ist nur dann zulässig, wenn der Betreiber gesonderte geeignete und notwendige Maßnahmen für die Personen- und Maschinensicherheit einhält und vornimmt. Änderungen und Liefermöglichkeiten vorbehalten.