

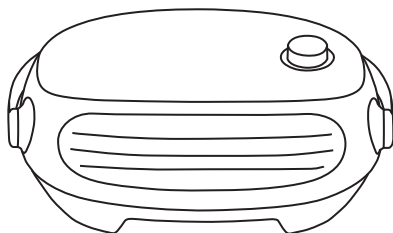

適用型號 MODEL

PBH-191

移動浴室寶
**PORTABLE
BATHROOM HEATER**



**使用說明
USER MANUAL**

i 使用產品前，請仔細閱讀本使用說明書。本產品僅限家居使用。

Before using the product, please read this user manual carefully and keep it for future reference.
This product is intended for indoor use.

i 本說明書中產品設計、規格及功能僅供參考，實際產品功能和規格可能會有不同。
產品資料如有更改，恕不另行通知。如中英文版本有差異時，應以中文版為準。

The product design, specifications and functions in this manual are for reference only. Actual product may vary. Product details are subject to change without prior notice. In case there is any inconsistency or conflict between English version and Chinese version of the terms, the Chinese version shall prevail.

Bear•為香港蝸居而誕生

成立於2006年3月，於2019年8月23日正式掛牌上市。

Bear微家電/小家電集合實用、多功能、簡約、時尚、小巧等多種特色，放在家裡每個角落，也能成為裝潢的一部分，營造出家居品味。這些特點讓 Bear成為香港小家庭及單身男女在選購小家電時的優先選擇。

Bear以人為本，產品由入廚到生活家電，滿足你生活上各種需求，對於繁忙又對生活有要求的人，絕對是家中必備。

幸福就是那麼簡單！

Bear帶給你生活中的一點甜蜜幸福。無論是忙碌早晨的一片果醬鬆脆厚多士，夏日午後的一杯清新慢磨果汁，還是冬日睡前的暖暖花果茶。Bear為香港人繁忙的生活打造出片刻寧靜與優雅，療癒你的身心靈。

Bear•小餐桌上的廚樂

不需要大廚房，不需要巧手廚藝，只要一張小餐桌及Bear小廚具家電，你也做到的簡單料理，讓每個人也可體驗入廚樂趣。

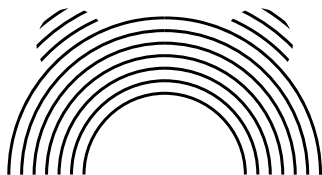



產品簡介

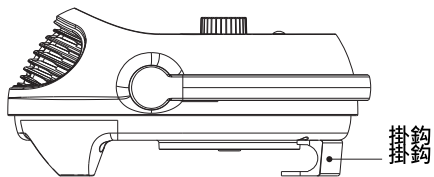
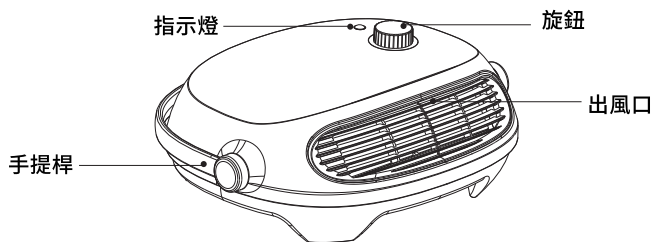
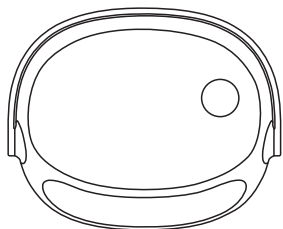



使用指南

安全注意事項

為防止觸電、火災、燙傷等事故，請遵守以下內容。

- 為避免過熱，禁止覆蓋加熱器。
- 請勿在無人看管下使用本產品。本產品僅適用於家庭使用。
- 請勿以拔插電源的方式開關本產品。
- 產品正常使用或閒置時，請遠離火源和火種1.5米以上，並避免陽光直射。
- 請勿在易燃、易爆、受熱易變形、變色、變質的物體附近或有嚴重粉塵的地方使用本產品。
- 請勿在有易落下懸掛物、易受衝擊或擺放不穩的地方使用。使用本產品時應平放，切勿翻倒或傾斜。
- 請勿將本產品浸入水中。在浴缸、花灑或泳池的四周不得使用本產品。
- 請勿用金屬絲或其他異物插入機體任何的孔縫中，以免發生觸電。
- 請勿將本產品對著電源插座，加熱器不可直接放置在電源插座下方。
- 請勿與其他大功率電器共用插座，請勿直接拉扯電源線移動本產品。
- 請勿把本產品當作動植物的保溫、加熱設備。
- 切勿擅自改裝產品或使用非生產商提供的零件進行維修，否則可造成危險既令保修服務無效。
- 產品長時間閒置時，請清潔乾淨，裝入包裝箱，置放於通風和乾燥的地方，以免受潮，影響使用。
- 本產品在使用時嚴禁小孩以及肢體不健全、感覺或精神上有障礙或缺乏相關經驗和知識的人單獨操作，若有小孩在旁，須加倍小心使用本產品。切勿將本產品置於小孩能觸及的地方。

功能說明

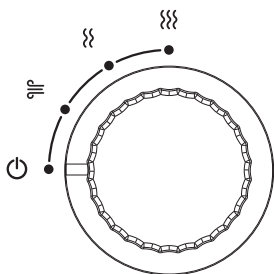

- ⏻ - 關閉
- 🌀 - 涼風
- 〰️ - 低檔暖風
- 〰️〰️ - 高檔暖風

使用場景說明

建議使用方式示範

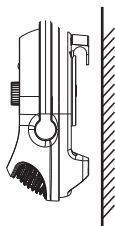

壁掛使用

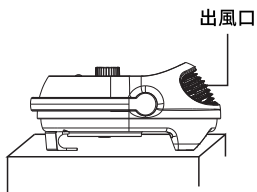

平放使用

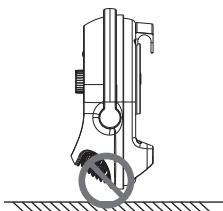

請勿貼地使用

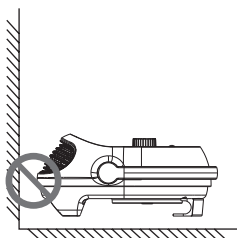

請勿對牆使用

安裝說明

安裝方法

用電鑽在牆上鑽出兩個水平距離為16.5cm的孔，再將釘膠塞入孔內，鑽入螺絲後再將機體背部兩個孔位勾到螺絲上。

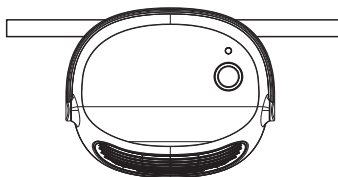
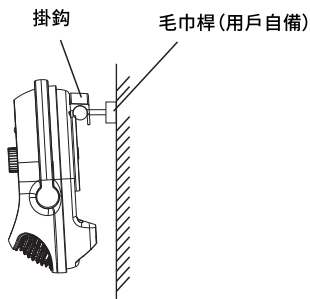
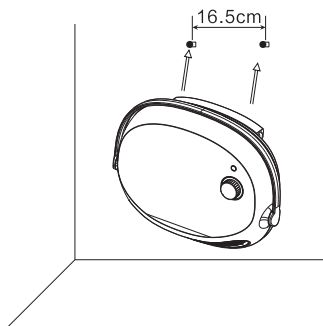
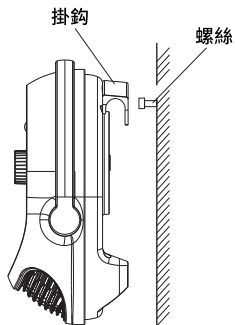

注意：

- 座枱式使用時：請將機體平放，將手提桿放置在機體的後方。請勿在座枱式使用狀態將手提桿插在出風口處。
- 座枱式使用時不可在浴缸、花灑頭或泳池附近使用。
- 螺絲掛腳必須安裝在同一水平上及安裝穩固。
- 掛牆使用時機體需與兩側牆身及其他物品保持50cm以上，上下60cm內不可有遮擋物，有利空氣對流。
- 本產品安裝高度不可低於180cm。
- 在浴室、泳池旁邊安裝使用時，必須防止本產品滑落浴缸、淋浴間及泳池內。
- 安裝位置請盡量遠離浴缸、花灑頭、泳池，並確保在浴缸內或池浴間內的人不能夠觸及到電源開關和其保控制器。



清潔及保養

1. 在清潔本產品前，請先關閉電源並且拔去電線插頭，待機體完全冷卻後再進行清潔。
2. 清潔保養後，必需待所有部件完全乾燥才可再次通電或收納。長時間不使用時，請先將
3. 電線插頭拔起，建議使用原包裝包好，收藏於乾燥的地方。
4. 禁止用水直接沖洗機身，可用含少量中性清潔劑的軟布輕擦，然後抹乾。請勿使用如天拿水等溶劑。
5. 請避免碰傷或劃傷產品，以免表面塗層受損。



常見問題

故障現象	原因分析	解決方法
加熱時突然停機	溫度超出限溫器閾值	待機體冷卻後再使用
接通電源後，電源指示燈不亮，無法運作。	開關按鍵接觸不良	檢查插頭是否正確插入插座內
	機體損壞	檢查檔位旋鈕是否旋轉至接通位



產品規格

產品型號	PBH-191
額定電壓	220V~
額定頻率	50Hz
額定輸入功率	1900W
外形尺寸(長x寬x高)	372X295X137 (mm)



Product Overview

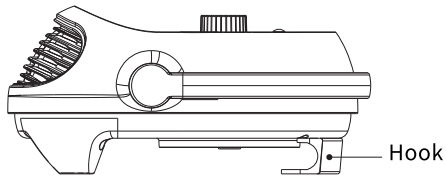
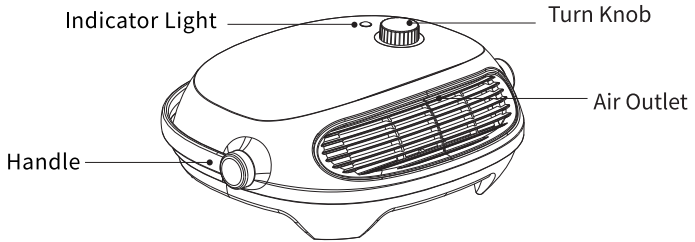
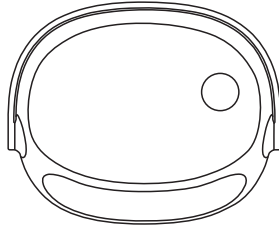



Instructions





Safety Instructions

Strictly observe the following instructions to prevent any accidents or injuries:

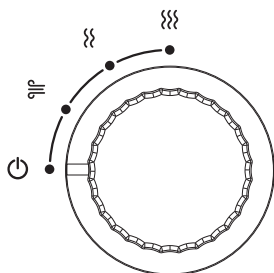
- To avoid overheating, do not cover the heater.
- This product is suitable for indoor use only, not for outdoor useage.
- Please properly dispose of the packaging materials and small articles, keep them away from infants or children to avoid any accident.
- Do not touch the plug or product with wet hand. Do not use the product with bare feet to prevent electric shock or other injury.
- Do not leave the product unattended when it is powered on.
- Please turn off the power and unplug from socket when not in use.
- Do not use the method of plugging (unplugging) the power cord to replace the power switch on and switch off.
- To prevent circuit overload, please do not insert other electrical appliances in the same socket.
- Please use grounded socket to prevent risk of electric shock.
- Do not pull the cable to disconnect the product from the power socket, always grasp and pull the plug to disconnect.
- Keep power cable away from the hot surface, sharp edge or avoid being squeezed.
- Do not use the cable to drag or move the product.
- Do not use the product if the cable or power plug is damaged or loosen when inserted into the power socket, in order to avoid risk of electric shock or fire.
- Do not use the product if it has been dropped or if there is visible damage.
- If there is any technical trouble or abnormal reaction, stop using the product immediately and unplug it to prevent accident.
- For safety reasons, do not attempt to disassemble, fix or perform other changes to the product. Please contact the dealer or customer service for examination and repair.
- Do not set the product close to fire or near flammable, perishable materials (such as gasoline) to avoid fire hazard.

Operating Instructions



-  - Off
-  - Fan
-  - Low Heat
-  - High Heat

Usage Instructions

Recommended Setting

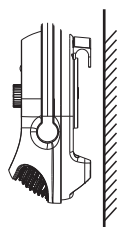

Floor

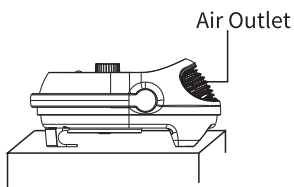

Desk

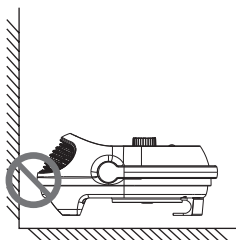
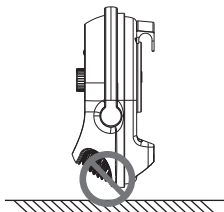

* Maintain a distance of at least 50 cm between the air outlets and walls or any other objects.

Instructions

1. Use the coordinate sheet to the mark position.
2. Use an electric drill to drill two holes (0.2 - 0.25cm in depth) on the wall with a horizontal distance of 16.5 cm.
3. Insert the screw plugs into the holes.
4. Insert the screws into the screw plugs and secure it.

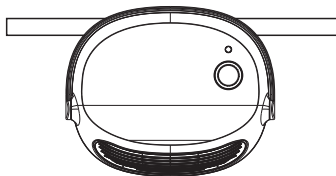
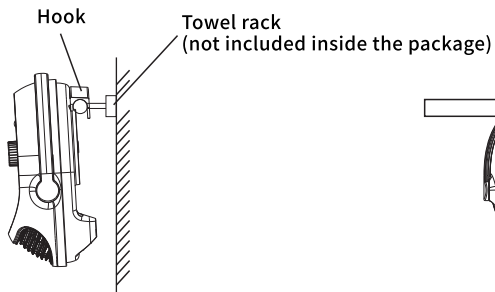
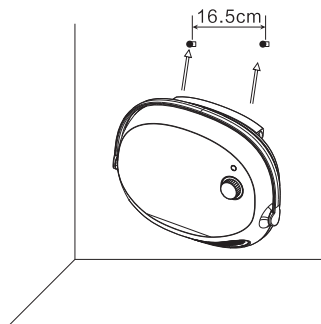
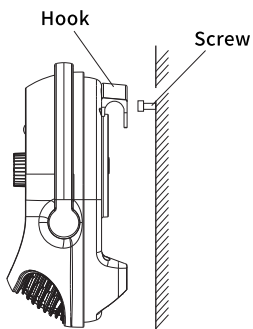

Reminder :

- When using the product on desk, please put the handle at the back of the body. Do not put the hook before air outlet.
- When placing this product on desk, do not use the product immediately surrounding bathtub, shower head or swimming pool.
- The product must be mounted on wall with a horizontal and stable surface.
- Please maintain a distance of at least 50 cm between the air outlets and walls or any other objects.
- The product must be mounted higher than 180cm.
- When using the product in bathroom or swimming pool, please avoid the product slide off in water.
- Make sure the product is mounted far away from the bathtub, shower or swimming pool.



Cleaning and Maintenance

1. Unplug the appliance and let it cool down before cleaning.
2. After Cleaning, make sure all the components are desiccated than it can be started to use or storage.
3. Put it into the packaging box and place it in a ventilated and dry place to prevent dampness.
4. Clean the surface and air outlet with a damp cloth. Do not use gasoline, thinner, or corrosive detergent or solvent.
5. To avoid the coating scrape off, do not use gasoline, thinner, or corrosive detergent or solvent.



Troubleshooting

Fault Description	Possible Cause	Solution
Stopped suddenly	Product is overheat	Turn it off and let it cool down.
Not functioning. The indicator light is not on.	Plug not inserted properly	Check whether the plug is inserted into the socket correctly.
	Product not switched on	Check if the knob is turned to the right position.



Specifications

Model	PBH-191
Voltage	220V~
Frequency	50Hz
Power	1900W
Dimensions	372x295x137mm

Bear

www.bears.com.hk

Bear

Manufacturer: **BEAR ELECTRIC APPLIANCE CO., LTD.**

Distributor: **HOMESTUFF INTERNATIONAL COMPANY LIMITED**

電郵 Email: info@bears.com.hk

官方網站 Official Website: www.bears.com.hk

Find Us On



Bear Hong Kong