

BAGGED VACUUM CLEANER
USER GUIDE
Model : RBC02

VYTRONIX

BUILT FOR EVERYDAY



RBC08/0510

IMPORTANT SAFETY INSTRUCTIONS

When using an electrical appliance, basic precaution should always be followed, including the following:

READ ALL INSTRUCTIONS BEFORE USING (THIS APPLIANCE)

WARNING-To reduce the risk of fire, electric shock, or injury:

1. Do not leave vacuum cleaner when plugged in. Unplug from outlet when no use and before servicing.
2. To reduce the risk of electric shock, do not use outdoors or on wet surfaces
3. Use only as described in this manual. Use only Vytronix recommended attachments.
4. Do not use with damaged cord or plug. If vacuum cleaner is not working as it should, has been dropped, damaged, left outdoors or dropped into water, please contact Vytronix.
5. Do not pull or carry by the cord, use the cord as a handle, close door on the cord, or pull the cord around sharp edges or corners. Do not run the vacuum cleaner over the cord. Keep the cord away from heated surfaces.
6. Do not unplug by pulling on cord. To unplug, grasp the plug, not the cord.
7. Do not handle plug or vacuum cleaner with wet hands.
8. Do not put any object into openings. Do not use with any opening blocked. Keep free of dust, lint, hair and anything that may reduce airflow.
9. Keep hair, loose clothing, fingers and all parts of body away from openings and moving parts.
10. Turn all controls off before unplugging.
11. Take extra care when using the vacuum on the stairs.
12. Do not use to pick up flammable or combustible liquids, such as gasoline, or use in areas where they may be present.
13. Hold plug when rewinding onto cord reel. Do not allow plug to whip when rewinding.
14. Unplug before connecting the hose
15. Do not pick up anything that is burning or smoking, such as cigarettes, matches or hot ashes.
16. Do not use without dust bag and filter in place.
17. If the supply cord is damaged, it must be replaced by Vytronix in order to avoid a hazard.
18. This appliance is not intended for use by persons such as children or those with reduced physical, sensory or mental capabilities, or lack of experience and knowledge, unless they have been given supervision or instructions concerning the use of the appliance by a person responsible for their safety.
19. Children should be supervised to ensure that they do not play with the appliance.

SAVE THESE INSTRUCTIONS!

Don't forget to register for your 12 month guarantee at www.vytronix.com using product code: **brandnew-vytronix-rbc02**

COMPONENTS AND EQUIPMENT

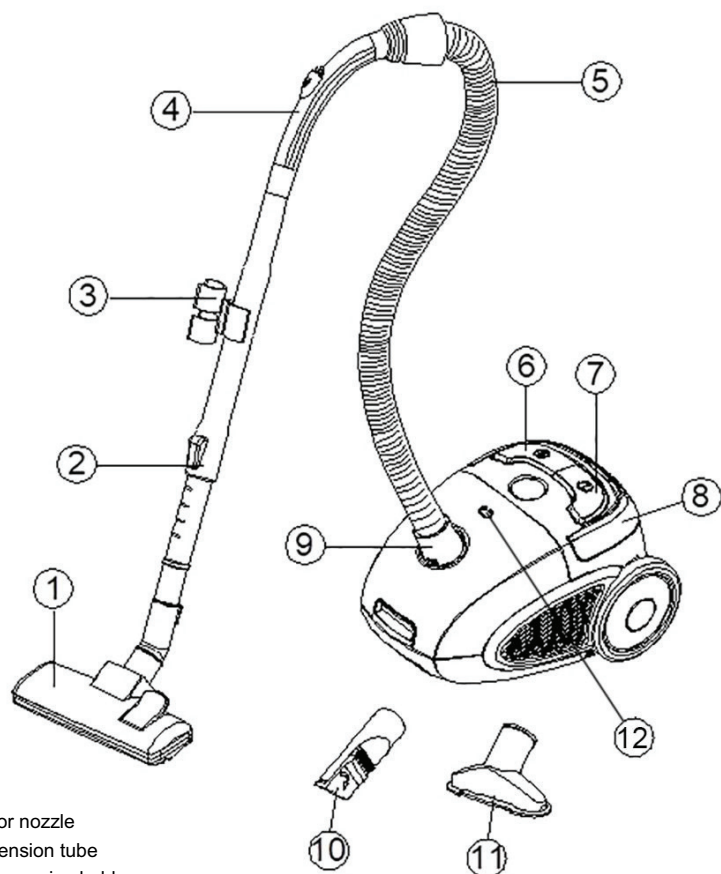

1. Floor nozzle
2. Extension tube
3. Accessories holder
4. Suction control slider
5. Suction hose
6. Cord rewind button
7. ON/OFF button
8. Carrying handle
9. Suction hose connection
10. Crevice Nozzle
11. Upholstery nozzle
12. Dust bag full indicator

Don't forget to register for your 12 month guarantee at www.vytronix.com using product code: **brandnew-vytronix-rbc02**

ACCIDENT PREVENTION

Switch off the vacuum cleaner immediately if the air intakes, the floor brushes or the telescopes tube becomes blocked. Before starting the vacuum cleaner up again remove the substance causing the blockage:

1. Never use the vacuum cleaner in the immediate vicinity of fires or radiators or any other appliance emitting heat. Do not suck up hot objects such as cigarette ends or ashes.

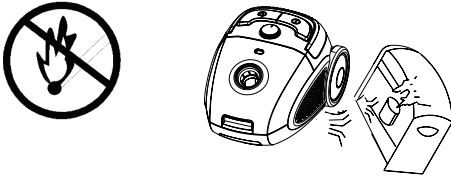

2. Only place the plug in the socket when your hands are dry.

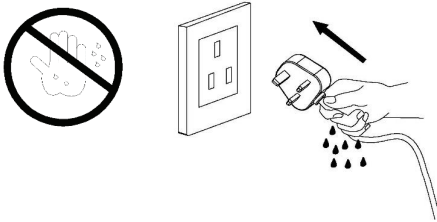

3. Please remove large or sharp objects from the floor before using the vacuum cleaner to avoid any possible damage to it.

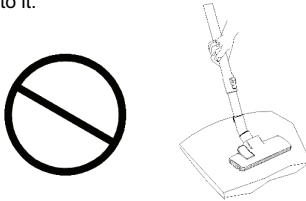

4. Do not pull by the mains cable when pulling out the plug.

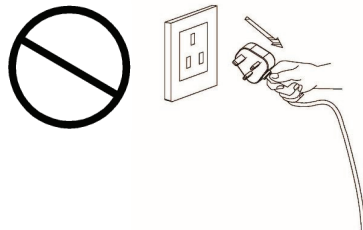

Don't forget to register for your 12 month guarantee at www.vytronix.com using product code: **brandnew-vytronix-rbc02**

PREPARING THE VACUUM CLEANER

Before starting

1. Open the dust bag cover and check that the dust bag is in place.
2. When you close the lid, ensure that the hole in the dust bag is lined up with the opening on the top cover of the vacuum.

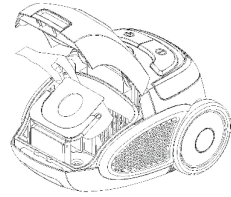

If during use, you discover dirt / debris inside the bag chamber, check the bag is fitted correctly.

3. Fit the hose on the vacuum cleaner by inserting the rotating hose connection into the vacuum cleaner until you hear a click. To remove the hose, press the button at the side of the hose connection and pull it out.

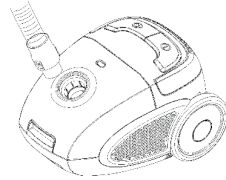

Assembling the telescopic extension tube and accessories

1. Fit the telescopic tube onto the other end of the hose.
2. Fit the floor brush onto the extension tube.

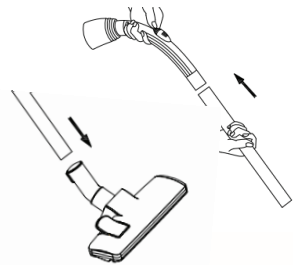

Floor Nozzle

The floor nozzle has two settings. When cleaning hard surfaces (parquet flooring, flooring tiles, etc.), the nozzle brushes should be extended. When cleaning carpets and mats, the brushes should be retracted into the nozzle. Press the brush change button to switch between the two settings.

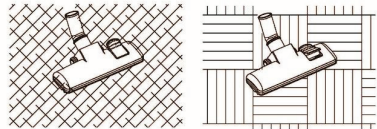

Cleaning carpet

Cleaning wooden floor

Crevice nozzle

For radiators, corners, skirting, etc.

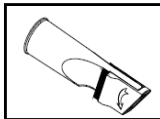

Furniture nozzle

For furniture, curtains, drapes, etc.

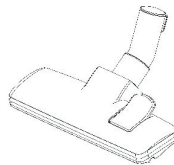
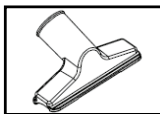

Don't forget to register for your 12 month guarantee at www.vytronix.com using product code: **brandnew-vytronix-rbc02**

USING THE VACUUM CLEANER

1: Before using the vacuum, first pull out a sufficient length of mains cable and plug into the mains socket. The yellow mark on the electric flex cable is the maximum length that must not be exceeded. To switch on the device, press the foot pedal button  on the casing with your foot or hand.



2: To rewind the power cable, press the button . Hold the cable with one hand and guide the cord  to ensure that it does not whip causing damage.

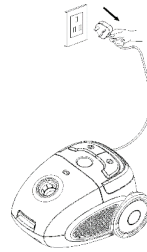

Caution:

Never operate the vacuum cleaner without the dust bag or motor filter fitted, otherwise the device could be damaged.

REPLACING THE DUST BAG

Replace the dust bag as soon as the “bag full” indicator becomes fully illuminated.

1. Switch off the vacuum and unplug from the mains power supply.
2. Remove the hose from the top cover of the vacuum and open the dust bag cover.
3. Carefully pull the cardboard holder to remove the dust bag and then dispose of full bag.
4. Insert a new dust bag by lining up the cardboard holder with the plastic tracks and sliding straight down.
5. Adjust the corners of the bag to fill the bag compartment.
6. Close the dust bag cover and check that the hole in the bag lines up with the opening on the top cover.
7. Reattach the hose and mains power and continue cleaning.

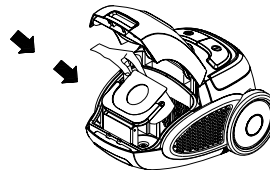
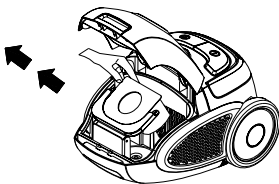

Don't forget to register for your 12 month guarantee at www.vytronix.com using product code: **brandnew-vytronix-rbc02**

Cleaning the motor filter

1. The motor filter can be found in the dust bag container.

It protects the motor from dust and should be cleaned at least twice a year, when it is dirty, or if suction force is reduced.

2. Pull the filter holder up out of the vacuum cleaner
3. open the filter holder and remove the filter. Rinse the filter in tepid water and allow it to dry for 24hours. Do not use a hair dryer or similar to dry the filter
4. Return the filter to the holder and replace the filter holder in the vacuum cleaner.

IMPORTANT! Never use the vacuum cleaner without a motor filter.

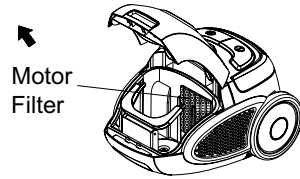

TROUBLE SHOOTING AND IMPORTANT INFORMATION

This Vacuum Cleaner is fitted with an internal safety thermal cut out.

The Vacuum Cleaner will switch off automatically when it overheats.

The Vacuum Cleaner may overheat if the filters are clogged, the hose is blocked or the dust bag is full.

If the Vacuum Cleaner cuts out, empty the dust bag, remove any blockages and clean the filter out before using again.

The Vacuum Cleaner will be functional again 30-60 minutes after cooling down.

TRANSPORT AND STORAGE

1. You can lift and carry the vacuum cleaner using the carrying handle. Never pull or lift the vacuum cleaner by the cord.
2. Before putting the vacuum away, rewind the cord. Switch off the socket, unplug, and press the cord rewind button until the cord is fully rewound.
3. To save space, the vacuum can be stored upright on its end cover. The telescopic tube can be hung on the vacuum cleaner by inserting the parking fixture into the vertical parking holder.

WARRANTY AND SPARES

To register your free one year Vytronix warranty visit www.vytronix.com/vytronix-product-registration

Your product code for registration is: **brandnew-vytronix-rbc02**

To purchase spares for your vacuum, please visit www.vytronix.com/spares

If you have any queries or require assistance with using your product, including set up, troubleshooting or registration please email our customer services team on support@vytronix.com

Don't forget to register for your 12 month guarantee at www.vytronix.com using product code: **brandnew-vytronix-rbc02**

SAFE DISPOSAL



This marking indicates that this product should not be disposed with other household waste throughout the EU. To prevent possible harm to the environment or human health from uncontrolled waste disposal, recycle it responsibly to promote the sustainable reuse of material resources. To arrange safe disposal of your used device, please use the return and collection systems or contact the retailer where the product was purchased.

If you have any queries or require assistance with using your product, including set up, troubleshooting or registration please email our customer services team on support@vytronix.com

Don't forget to register for your 12 month guarantee at www.vytronix.com using product code: **brandnew-vytronix-rbc02**

EU DECLARATION OF CONFORMITY

No.: 20LVD1402AC03
Manufacturer:
Company name: Vytronix Ltd
Address:
260-270 Butterfield
Great Marlings
Luton
LU2 8DL
United Kingdom

Authorized Representative:
Company name: Alura Group BV
Address:
Kroonwiel 2
Weert
6003 BT
Netherlands

This declaration of conformity is issued under the sole responsibility of the manufacturer.

Object(s) of the declaration:

RBC02 Bagged Cylinder Vacuum

The object of the declaration described above is in conformity with the relevant Community harmonization legislation:

- *Directive 2014/30/EU of 26 February 2014 on the harmonisation of the laws of the Member States relating to electromagnetic compatibility (recast)(in short referred to as "the EMC Directive");*
- *Directive 2014/35/EU of the European Parliament and of the Council of 26 February 2014 on the harmonisation of the laws of the Member States relating to the making available on the market of electrical equipment designed for use within certain voltage limits (in short "the Low Voltage Directive" or "the Low Voltage Equipment Directive"),*
- *Directive 2011/65/EU of the European Parliament and of the Council of 8 June 2011 on the restriction of the use of certain hazardous substances in electrical and electronic equipment (in short referred to as "the RoHS Directive" or "2011/65/EU"),*
- *Directive 2012/19/EU of the European Parliament and of the Council of 4 July 2012 on waste electrical and electronic equipment (WEEE) (in short referred to as "the WEEE Directive" or "2012/19/EU")*

References to the relevant harmonised standards used or references to the specifications in relation to which conformity is declared:

EN 55014-1:2006+A1+A2; EN55014-2:1997+A1+A2; EN 61000-3-2:2006+A1+A2; EN 61000-3-3:2013; EN 60335-1:2012+A11:2014+A13:2017; EN 60335-2-54:2008+A11; EN62233:2008

Additional information:

Signed for and on behalf of Vytronix Ltd
Great Marlings, LU2 8DL, 11 March 2020

Ross Taylor
Director
..... (Signature)

Don't forget to register for your 12 month guarantee at www.vytronix.com using product code: **brandnew-vytronix-rbc02**



If you have any queries or require assistance with using your product, including set up, troubleshooting or registration please email our customer services team on support@vytronix.com