



CYCLING BEARS

Table of Contents

About Us	6
Pent.	9
Colmia™	11
Colmia™ Light Horizontal	12
Colmia™ Power Horizontal	13
Colmia™ Ultimate Set Vertical	14
Lova™	16
Moxa™	18
Lesna™ & Bystra™	20
Banka™	22
Scala™ Advance Plus	26
Scala™ Basic	27
Lina™	28
Pent. Accessories	29
Pent. Multifunctional Sets	33
Ciclote	39
Teckell™	40
Bike	42
Nohrd™	45
Sprintbok	46
WaterRower	48
Slimbeam	51
Stil-Fit	53
Ergometer Pure	54
Functional Trainer	56
Flow One	59
Showroom	61





The world's
finest fitness
equipment
curated and
customized
just *for you.*

About Us



Cycling Bears designs fitness spaces for homes, hotels, yachts and private clubs, and supplies the finest fitness equipment which are all customisable to blend in seamlessly with your luxurious space.

Using sustainably sourced natural materials and working with partners who share similar beliefs, Cycling Bears uses equipment that do not have any planned obsolescence.

We welcome you to experience luxury first-hand at our showroom where we have featured a range of our products for you to try out, amidst the earthy warmth of the wood and the intoxicating scent of leather.

Current Trends

In this post covid world, wellness and health are top of mind for most people and many want their own fitness space at home. To differentiate themselves, hotels, spas, resorts are currently developing high-end fitness centres, coaching programs and classes for travellers who want to stay fit while on the road.

A common issue today is a less-informed consumer being sold more than required equipment by suppliers who have a 'sales first' approach.

In line with the needs and demands of our clients, we have curated fitness equipment that covers all essential aspects - function, form, design and sustainability.





Bespoke Solutions

We work with our clients, interior designers and architects to create the perfect fitness space, following a three-step-process.

1. We first understand your fitness goals so that we can identify what equipment would best suit your needs.
2. We then work on the spatial planning when specifying the equipment.
3. Finally, we work on the aesthetic customization -materials, colour and personalization.

Our products cater to both form and function by featuring elegant designs. They are handmade from natural materials that you feel comfortable working out on them -like real wood, which exudes warmth while having antibacterial properties, natural Italian leather and marine grade stainless steel.

No two projects are identical.

A modern gym interior with a dark grey wall and light grey wood-look flooring. In the background, a tall wooden ladder stands against the wall. To the left, a wooden rack holds six grey medicine balls. In the foreground, a wooden bench with a grey cushioned top is positioned on the floor. A large window on the right side of the frame offers a view of a lush green forest. A white rectangular box is overlaid in the center of the image, containing the text 'PENT.'

PENT.

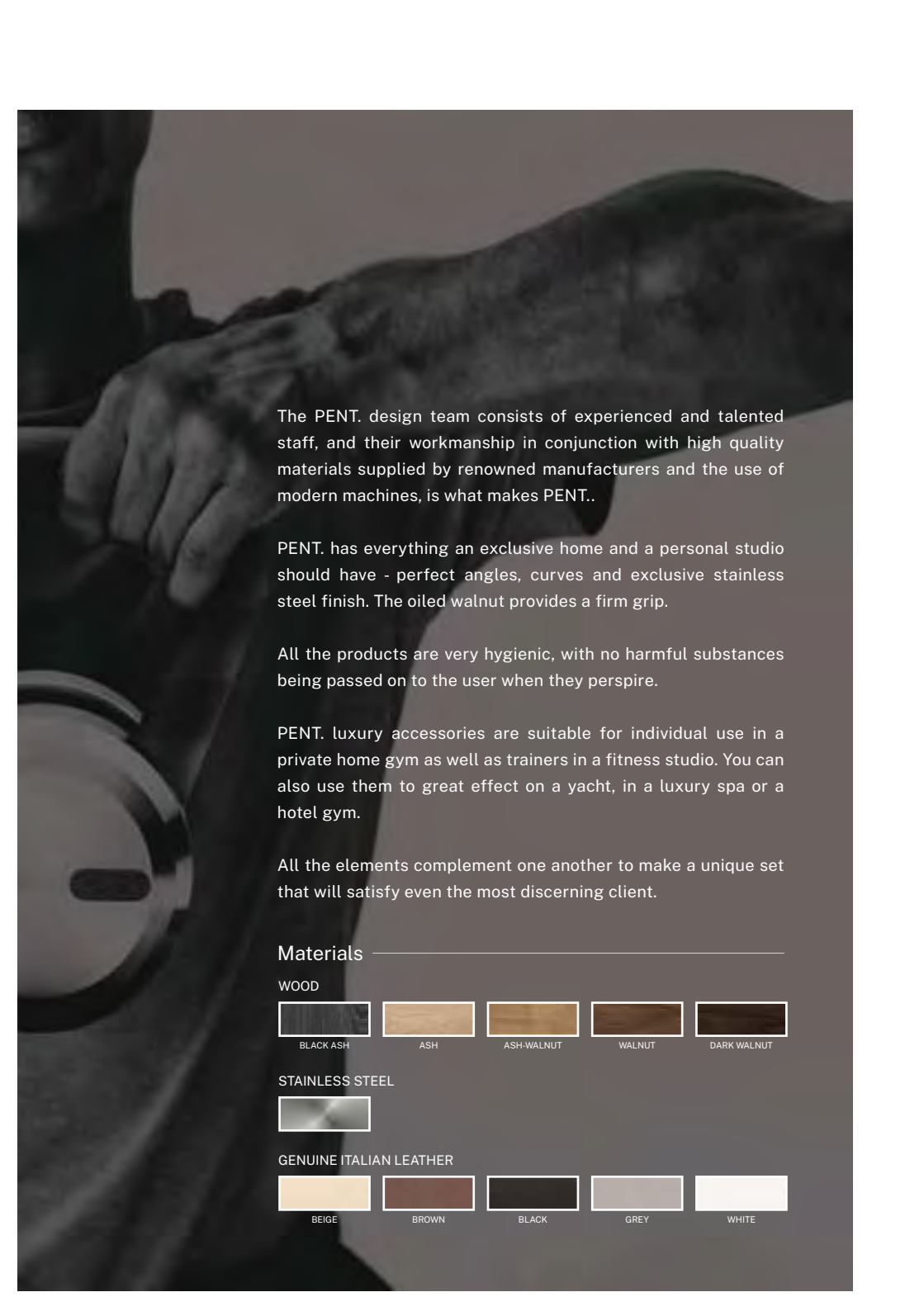

The PENT. design team consists of experienced and talented staff, and their workmanship in conjunction with high quality materials supplied by renowned manufacturers and the use of modern machines, is what makes PENT..

PENT. has everything an exclusive home and a personal studio should have - perfect angles, curves and exclusive stainless steel finish. The oiled walnut provides a firm grip.

All the products are very hygienic, with no harmful substances being passed on to the user when they perspire.

PENT. luxury accessories are suitable for individual use in a private home gym as well as trainers in a fitness studio. You can also use them to great effect on a yacht, in a luxury spa or a hotel gym.

All the elements complement one another to make a unique set that will satisfy even the most discerning client.

Materials

WOOD



BLACK ASH



ASH



ASH-WALNUT



WALNUT



DARK WALNUT

STAINLESS STEEL



GENUINE ITALIAN LEATHER



BEIGE



BROWN



BLACK



GREY

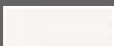

WHITE

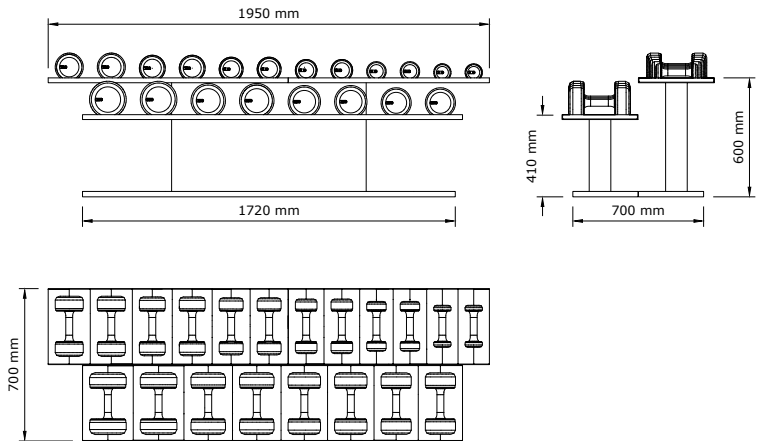

COLMIA™ HORIZONTAL ULTIMATE SET - 2 to 20kg

Bespoke luxury dumbbells, simply designed, in a combination of wood and stainless steel. Natural wood provides a good grip and exhibits antibacterial properties. Stainless steel is resistant to corrosion which is crucial when using these luxurious accessories in exposed conditions.

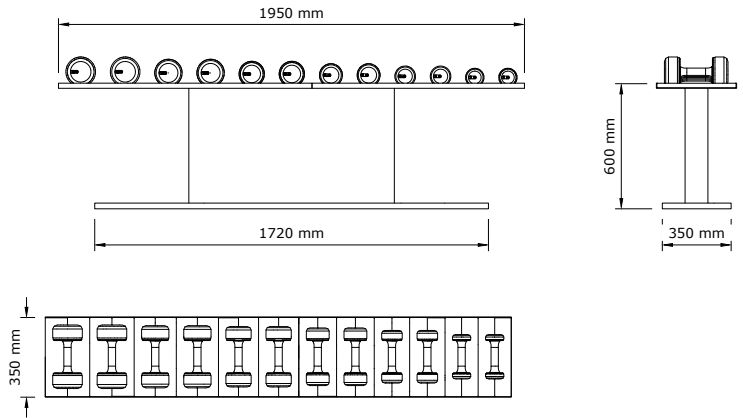

COLMIA™ LIGHT HORIZONTAL

Bespoke luxury dumbbells, simply designed, in a combination of wood and stainless steel. Natural wood provides a good grip and exhibits antibacterial properties. Stainless steel is resistant to corrosion which is crucial when using these luxurious accessories in exposed conditions.

Available as an individual pair, or in a complete set on a handmade horizontal or vertical stand, from 2 to 30kg.

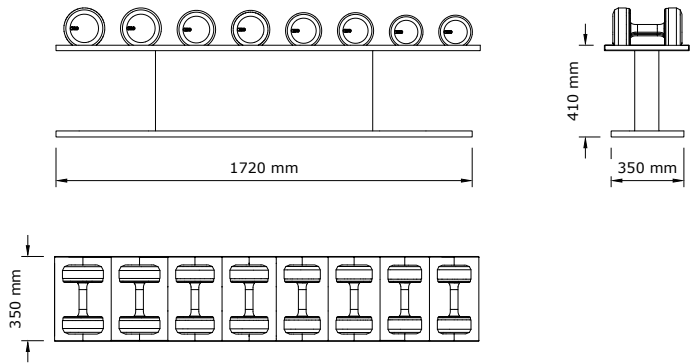

COLMIA™ POWER HORIZONTAL

Bespoke luxury dumbbells, simply designed, in a combination of wood and stainless steel. Natural wood provides a good grip and exhibits antibacterial properties. Stainless steel is resistant to corrosion which is crucial when using these luxurious accessories in exposed conditions.

Available as an individual pair, or in a complete set on a handmade horizontal or vertical stand, from 2 to 30kg.

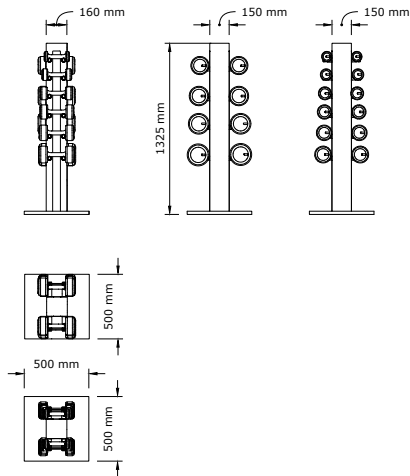

COLMIA™ ULTIMATE SET VERTICAL

Bespoke luxury dumbbells, simply designed, in a combination of wood and stainless steel. Natural wood provides a good grip and exhibits antibacterial properties. Stainless steel is resistant to corrosion which is crucial when using these luxurious accessories in exposed conditions.

Available as an individual pair, or in a complete set on a handmade horizontal or vertical stand, from 2 to 30kg.



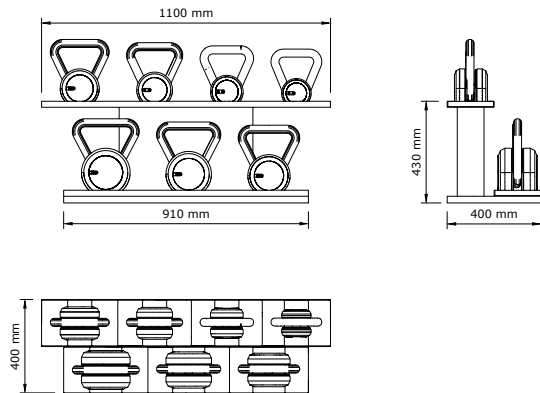

LOVA HORIZONTAL ULTIMATE SET-4 to 20kg

Bespoke luxury Kettlebells ergonomically designed while exuding quality, they are an assembly of wood and stainless steel. Natural wood provides a good grip and exhibits antibacterial properties. Wood and Steel marry well, creating a harmonious system of health and nature. Our stainless steel is resistant to corrosion which is crucial when using these luxurious accessories in exposed conditions.

Available individually, or in a complete set on a handmade horizontal or vertical stand, from 4 to 24kg.



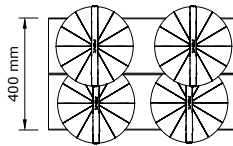
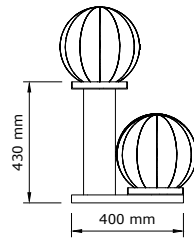
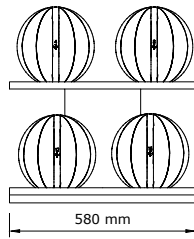

MOXA HORIZONTAL POWER SET -12 to 24kg

Each Medicine Ball is Handmade from Genuine Italian Leather, while the stand is hand crafted from natural wood, stainless steel and genuine Italian leather. It is just as practical as it is good looking!

Available individually, or in a complete set on a handmade horizontal or vertical stand, from 4 to 24kg.



LESNA™ & BYSTRA™ SET

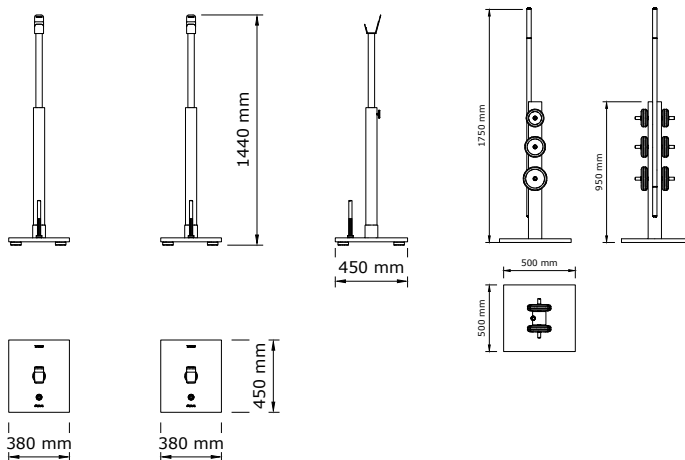

LUXURY BARBELL SET & BENCH PRESS RACK — UP TO 70KG

A barbell set handmade of the best luxury materials. The stylish and simple form of the stand is perfectly matched with the selection of weights. As with all our products, the attention to details and hours of handmade work make the set refined in every aspect, delighting everyone who has the opportunity to see it with their own eyes. It is ideal for a home or a hotel gym. Available in bench press rack option.



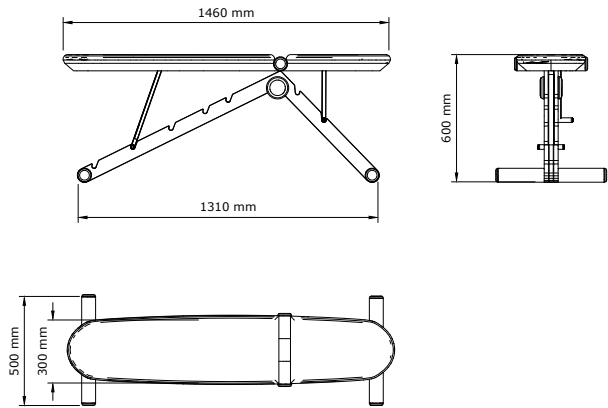

LUXURY FITNESS BENCH

Wooden bench combined with a stainless steel core, it is constructed conscientiously to provide comfort fitting both your body and your weight lifting needs. Its shape allows you to reach with maximum movement while providing stability while exercising. Wood is lighter and softer in touch than steel. The very first reps will bring noticeable difference to the back. It is worthy to note the antibacterial properties of the natural wood used in this handmade equipment. The combination of simplicity and design makes this perfect for both the home and public gyms which seek prestige and comfort.



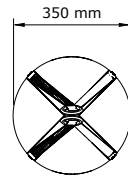
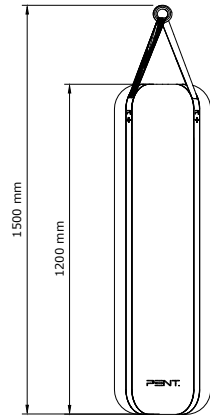

LUXURY GENUINE LEATHER BOXING BAG AND GLOVES

PENT. boxing bags have proven their reliability in the most extreme conditions in home, residential & hotel luxury gym. To ensure the quality of its products, PENT. designs and produces in-house the essential components of its. Add some luxury style to your gym or training area with a stunning genuine leather bag from PENT.



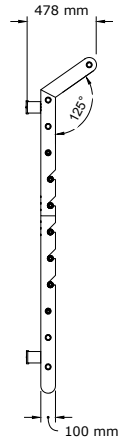
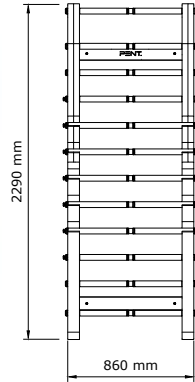

SCALA™ ADVANCE PLUS WALL BAR

The set combines a frame, which is wall and floor mounted, and 5 removable rods weighing 2 to 6 kilograms for functional training TRX-a training tool which uses the weight of the rod and weight of the user to perform complex multi-functional exercise. Ergonomics and functional utility are the design cues of the Scala wall bar, its dimensions and options available. The set is available in solid natural wood, treated with a carefully selected mineral oil. Metal parts are made of stainless steel which is resistant to the specific conditions prevailing in the gym.

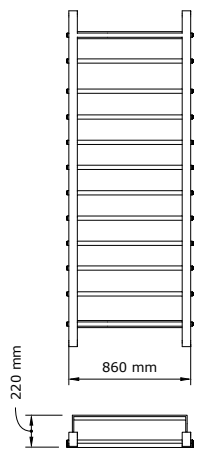

SCALA™ BASIC WALL BAR

Bespoke luxury dumbbells, simply designed, in a combination of wood and stainless steel. Natural wood provides a good grip and exhibits antibacterial properties. Stainless steel is resistant to corrosion which is crucial when using these luxurious accessories in exposed conditions.

Available as an individual pair, or in a complete set on a handmade horizontal or vertical stand, from 2 to 30kg.

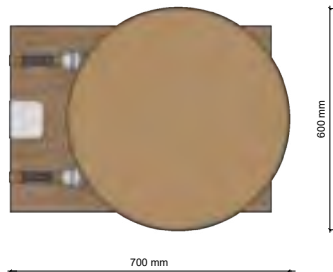
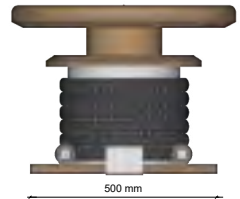
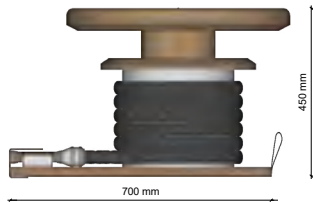

LUXURY BATTLE ROPE WITH STAND

This battle rope comes with marine grade stainless steel and wooden handles, wrapped in luxurious Italian leather, packed neatly into its own handmade wooden stand, which has a leather seat.

A modern gym is set up on the deck of a yacht. The gym equipment, including dumbbells and kettlebells, is neatly arranged on wooden racks. The deck is made of light-colored wood, and the background shows a clear blue sky and the ocean. The text "PENT. ACCESSORIES" is overlaid in the center of the image.

PENT.
ACCESSORIES

PENT. ACCESSORIES



ROLA™
LUXURY FITNESS ROLLER



KOHA™
LUXURY YOGA BLOCK



PASA™
LUXURY YOGA STRAP



MESNA™
LUXURY FITNESS BALL



MATA™
LUXURY FITNESS MAT

PENT. ACCESSORIES



SIENNA™
LUXURY SKIPPING ROPE



TRESNA™
LUXURY BALANCE BALL



KALNA™
LUXURY HANDMADE BULGARIAN BAG



TWISTA™
LUXURY AB ROLLER WHEEL



LIPOVA™
LUXURY PUSH UP BARS





PENT.
MULTIFUNCTIONAL SETS

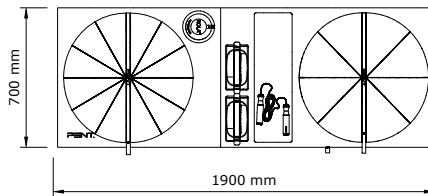
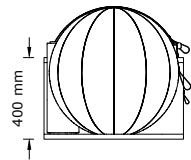
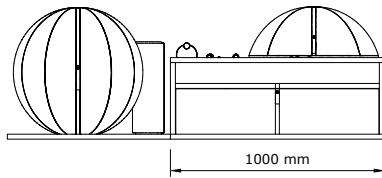

LUXURY SET OF FITNESS ACCESSORIES

Upgrade your fitness gear with PENT. Luxury fitness accessories. Are you a devoted fitness lover and a design addict? Well, look no further than PENT., the equipment brand that ticks all the boxes. RACKA™ stand has a goal of providing consumers with customized equipment that suits their needs in terms of athletics and aesthetics alike.

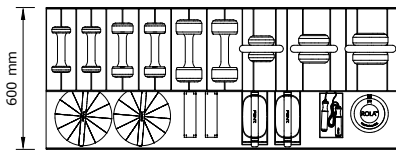
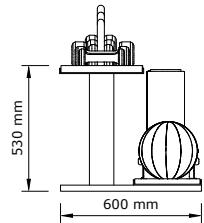
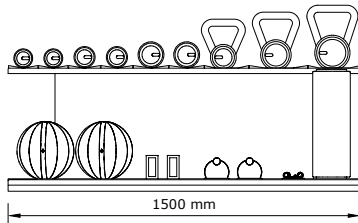

LUXURY SET OF FITNESS ACCESSORIES

PENT. is not just a fitness equipment, but also a beautiful piece of furniture. Are you a devoted fitness lover and a design addict? Well, look no further than PENT., the equipment brand that ticks all the boxes. We have a goal of providing customized equipment that suits the consumer's athletic and aesthetic needs.

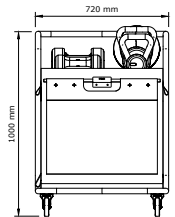
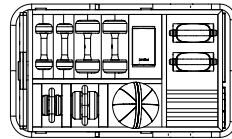
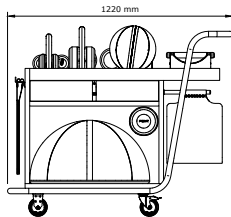

THE GLOBAL INNOVATION

Created as a complete set for the most demanding people. Complementary set of dumbbells, kettlebells, exercise mat and essential fitness accessories. The ergonomic design includes drawers for smaller but extremely important accessories such as a jump rope or a push-up device. A place for towels, water and an Ipad with your favorite music or exercise routines from your library.

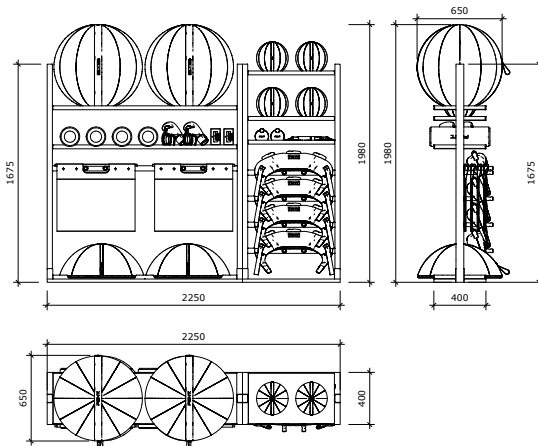

SOFT EQUIPMENT AND ACCESSORIES STORAGE SOLUTION

The Stora is a compact stand that neatly stores workout equipment. Ideally suited for hotels or larger home gyms, it artfully displays your entire collection. In order to ensure safety and best results, STORA requires to be fixed permanently to a wall (fixing solution provided).



A red stationary exercise bike is positioned in a bright room with large windows. A red lamp hangs from the ceiling, and a white table with chairs is visible in the foreground. The bike has a large red flywheel and a black seat. The brand name 'CICLOTTE' is visible on the flywheel.

CICLOTTE[®]

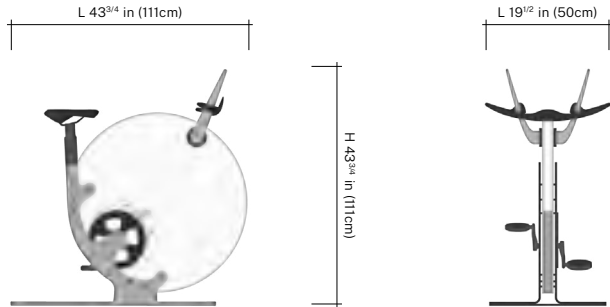

LUXURY CRYSTAL EXERCISE BIKE

Ciclote Teckell™, with its minimalistic shapes, is the only designer exercise bike in crystal. Developed by following an accurate ergonomic study and featuring a transmission with a turn multiplier system, the bike is able to replicate the sensation of pedalling on the road and ensure high training workouts. Ultimate solution for the interior of private home gym, Ciclote Teckell™ is the modern exercise bike conceived for the interior design of luxury homes, office contractors, hotel gyms and amazing yacht fitness activities.



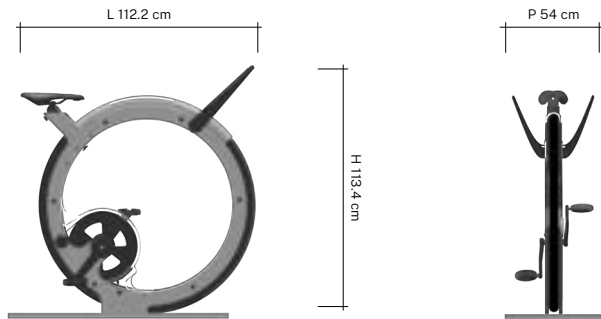

LUXURY EXERCISE BIKE

Conceptualised by Milan-based designer Luca Schieppati, this award-winning designer exercise bike, boasting an iconic circular shape, is bound to anchor any space it occupies. Performance wise, the bike is equally impressive, featuring five spinning positions and a turn multiplier transmission to replicate the sensation of cycling on the road.







SPORT IN STYLE

SPRINTBOK



The Sprintbok by NOHRD's most appealing aesthetic feature is its smoothed, curved frame design made of solid hardwood. In function, the wooden frame contributes to vibration reduction when the machine is in use. Using the highest quality materials, the Sprintbok is a maintenance-free machine. Aside from regular dusting of all surfaces, there is no belt-tightening, oiling or greasing of parts necessary.

Materials





WATER ROWER

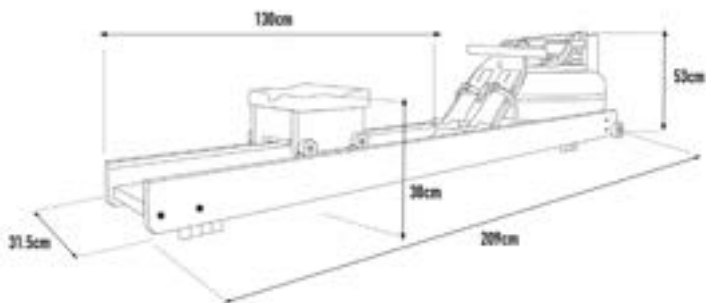

The WaterRower was invented by American, John Duke in 1988. It was developed to function easily and simulate the given conditions on water as closely as possible. Each WaterRower rowing machines have been manufactured with the utmost care and passion for detail for more than 25 years. These machines stand for design in your home interior, at the workplace and in the fitness spece of any luxury hotel.

Materials



ASH



OAK



CLUB



CHERRY



WALNUT





SLIMBEAM



The SlimBeam is an award-winning professional, multi-use cable station. One of its key features is the butterfly function, allowing you to train on one or both sides. It can be swiveled and set to any height. The sleek and straightforward use of forms, along with its selection of high-quality wood, render the SlimBeam the appeal of an exquisite piece of furniture, which will fit into any home interior or private gym.



An aerial, black and white photograph of a rowing team on a body of water. The team consists of several rowers in a long, narrow boat, with their oars dipping into the water. The water shows ripples and a wake from the boat. A white rectangular box is superimposed over the center of the image, containing the text 'STIL-FIT INT.' in a clean, sans-serif font.

STIL-FIT^{INT.}

ERGOMETER PURE



The STIL-FIT ergometer offers you everything you need for an efficient cardio workout in the smallest of spaces. Perfect ergonomics, sophisticated technology and innovative equipment. Our goal was to develop an ergometer that can be easily integrated into any living environment. We are convinced that this is the only way to achieve a real and permanent fitness effect



NTL 917

FUNCTIONAL TRAINER

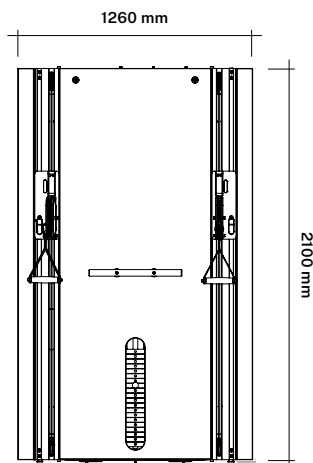
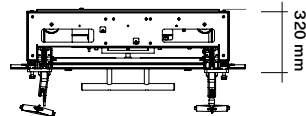

MAKE EVERY ROOM A WORKOUT ZONE

Our unique Functional Trainer provides you with a complete gym in the smallest space. It was designed to meet today's demands for an active and individual lifestyle. Elegant, flexible, adaptable and ideal for a comprehensive strength training with free, three-dimensional movements to improve strength, coordination and flexibility.

FUNCTIONAL TRAINER ACCESSORIES



BICEPS BAR-TRICEPS BAR
BLACK



BICEPS BAR-TRICEPS BAR
WALNUT



CHOP BAR
BLACK



CHOP BAR
WALNUT



LATBAR
BLACK



LATBAR
WALNUT



FOOTSTRAP LEATHER



FLOW ONE



LUXURIOUS WOODEN ROWING MACHINE

The beautiful feeling of powerfully rowing the slender and elegant body of a rowing boat over a quiet lake or along a calm river. Every powerful stroke of the oar lets the slim boat glide elegantly through the water. The STIL-FIT rowing machine FLOW ONE combines an elegant design, which is reminiscent of a slim rowing boat, with the sound of oars diving into the water and thus conveys precisely this sensual experience.

FLOW ONE is the rowing machine that fits into any living environment, during the workout and afterwards. It can be easily stored vertically, takes up only half a square meter of space and decorates every room.



Showroom

We welcome you to experience luxury first-hand at our showroom where we have featured a range of our products for you to try out, amidst the earthy warmth of the wood and the intoxicating scent of leather.

We are moving closer to our clients all around the world and have showrooms in Singapore, Melbourne and Manila and are excited to help you design your fitness sanctuary!







 info@cyclingsbears.com

 +65 8620 3760

 www.cyclingsbears.com



Singapore

387 Joo Chiat Road,
Singapore 427623

Melbourne

W1.04/15-87 Gladstone Street,
South Melbourne, VIC 3205 Australia

Manila

Unit 474, Level 4, Main Wing,
Shangri-La Plaza, EDSA corner
Shaw Boulevard, Mandaluyong City,
Philippines