

Operation Manual

TPB

Interface Scale

V1.1

CONTENTS

1. INTRODUCTION	1 -
2. INSTALLATION	1 -
2.1 Installation	1 -
2.2 Leveling	1 -
2.3 Power Connection	1 -
2.4 Rechargeable battery operation	1 -
2.4.1 Charging the battery	2 -
2.4.2 Battery maintenance	2 -
3. KEYS DESCRIPTION	2 -
4. DISPLAY SYMBOLS	3 -
5. OPERATION	3 -
5.1 Switching on/off	3 -
5.2 Zeroing	3 -
5.3 Using Tare	3 -
5.4 Select Weighing Units	4 -
5.5 Back light Setting	4 -
5.6 Power auto off	4 -
5.7 Bluetooth Operation (Optional)	5 -
5.7.1 Bluetooth Testing Tool Installation	5 -
5.7.2 CON1 Communication Protocol Testing	5 -
5.7.3 CON2 Communication Protocol Testing	7 -
5.7.4 ASK Command Testing	9 -
5.8 POS/ECR protocol selection	11 -
6 PARAMETER SETTING	12 -
6.1 MENU BLOCK	13 -
7. DIAGRAM: Serial interface	14 -
8. SPECIFICATION	15 -
9. DIMMENSIONS(inch/mm)	16 -
10.ERROR MESSAGE	17 -

1. INTRODUCTION

- The TPB series interface scale that amplifies signals from a load cell, converts it to digital data and displays it as a mass value
- It is suitable for general weighing applications
- 15 mm LCD with white LED back light display
- Standard RS232 port can be connected to computer, ECR or POS
- Capacity 6 kg to 30 kg (12 lb to 60 lb)

2. INSTALLATION

2.1 Installation

- Remove transport lock from bottom of the scale base
- Place the scale on a level surface
- Install the stainless steel pan on top of the plastic pan

2.2 Leveling

- The scale is equipped with a level indicator located back side of device.
- Use the adjustable leveling feet located on the bottom of the scale until the bubble appears in the center of the indicator.

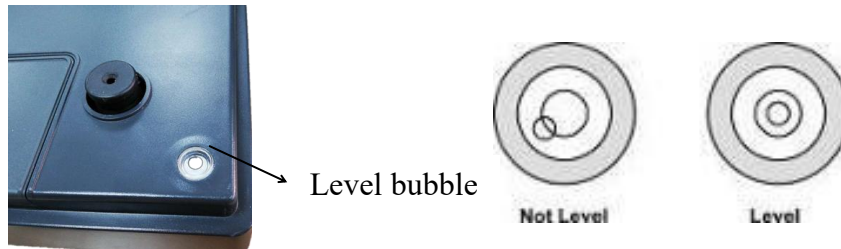

2.3 Power Connection

- Connect the adaptor pin into the indicator adaptor jack. Adaptor jack is locating below the left side of the scale.
- Adaptor connects into your AC power socket. Pluggable equipment must be installed near an easily accessible socket outlet with a protective ground/ earth contact.

2.4 Rechargeable battery operation

Note: Please charge the battery before using the scale for the first time.

- The symbol BATT on the weight display indicates that the battery is getting low. it's time to charge the battery with the AC power. If scale goes on being used without proper charging, <BAT-LO> words will flicker on the display.
- Approximately 1 hours of instrument usage are left; afterwards it will shut off automatically.
- Please use the supplied battery charger for charging the battery immediately, or scale cannot be used.

2.4.1 Charging the battery



- Before the first use, the battery should be charged by connecting it to the mains power supply for at least 10 hours.
- When the scale is plugged into the mains power the internal battery will be recharged.
- Verify that the AC power socket outlet is properly protected.
- Right side of the weight display there is an charging LED to indicate the status of battery charging
- Charge status of rechargeable battery is indicated by the LED display.
 Red: Charging storage battery
 Green: Rechargeable battery is completely charged

2.4.2 Battery maintenance

- Do not use any other type of power adaptor than the one supplied with the scale.
- Recharge battery should be charged in every three months when not in use.
- If the scale is not used for an extended period of time,remove the battery from the battery compartment to avoid leakage.
- Store the battery in a sealed bag or box in a dry, temperate environment.

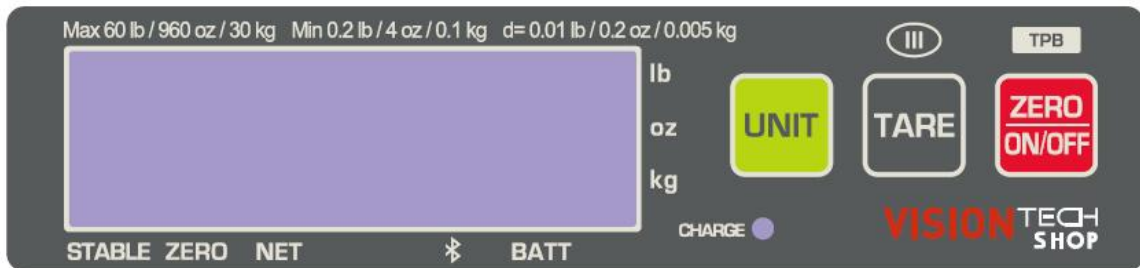
3. KEYS DESCRIPTION





Keys	Description
	1)On/Off key,Used to switch on/off the scale. 2)Zero key,Used to clear and zero the display. 3) Enter key, Used to confirm selection in parameters option. 4)Left arrow key. Used to shift the location and move the digit to the left.
	1)Tare key,Used to perform a tare function, Subtracts weights. 2)Value increment key. Used to change the selected digit value. 3)Set up key,Used to enter setup menu setting. 4)To change the menu option in menu setting.
	1)Units key,Used to change weighing units(kg/lb/oz).

4. DISPLAY SYMBOLS

CHARGE	Charging indicator, indicates scale has been connected with power
STABLE	Stable indicator. Indicates the scale weight is stable.
NET	Net indicator. Indicates scale is displaying the net weight.
ZERO	Zero indicator. Indicates the scale is at zero.
kg	Indicates the unit of measure in use (kilogram).
lb	Indicates the unit of measure in use (pounds).
oz	Indicates the unit of measure in use (ounces).
	Bluetooth indicator, Indicates the scale is in Bluetooth mode
BATT	Battery low indicator, Indicates the battery need to be charged

5. OPERATION

5.1 Switching on/off

- Switch on the scale by pressing  key, Display will be show the scale version and then come to normal weighing mode.
- To switched off the scale, press  key again.

5.2 Zeroing

Environmental conditions can lead to the balance exactly zero in spite of the platform not taking any strain. However, you can set the display of your balance to zero any time by

pressing  key and therefore ensure that the weighing starts at zero.

5.3 Using Tare

To enable Tare function, it's required to enter parameters to select f4 tare >ON, Before access to the parameter, it need to press the calibration switch that is locating below the scale.

The weight of any container can be tared by pressing  button so that with subsequent weighing the net weight of the object being weighed is always displayed.

Taring a container

- Load weight on the platform.
- Press  key. Zero is displayed, and tare is subtracted. The [▼] indicator above Net indicator appears.
- Remove weight on the platform. Tared weight is displayed. It can set only one tare value. It will be shown with a minus value.

Clearing tare





- To clear the tare value, remove the load from the platform
- Press  key. Zero is displayed, The [▼] indicator above Net indicator disappears ,tare weight is cleared.

5.4 Select Weighing Units

By pressing  key in turn in normal weighing mode, it can convert the weighing units (kg/lb/oz), the relative symbol will turn on in the display.

5.5 Back light Setting





It allows choosing the back light operation.

- 1 Press  key during that start up ,display will be show "FO bL"
- 2 Press  key to enter.
- 3 Press  key to change the settings back light display mode to Auto/Off/On.
- 4 Press  key to confirm.

Display	Description
AUTO	Backlight will be turned on, when start to use or when weight is not in zero.
oFF	Backlight function will be turned off
on	Backlight will be always turned on

Note:If battery is getting low, the backlight function will not available

5.6 Power auto off

- 1 Press  key during that start up ,display will be show "FO bL".
- 2 Press  key to select the menu until display show "F I oFF".
- 3 Press  key to confirm.
- 4 Press  key to select the options.

F1 OFF	off	To set auto off function turn off, for scale always on
	3	Set to turn off 3 minutes later
	10	Set to turn off 10 minutes later
	30	Set to turn off 30 minutes later

5.7 Bluetooth Operation (Optional)







5.7.1 Bluetooth Testing Tool Installation

Note: The following steps used for testing communication (only BLE Utility available for testing)



- Turn on the BLE Utility software  in your phone, it can be download from AppGallery
- Scale should be in the allowed limits of the distance to connect Bluetooth.

5.7.2 CON1 Communication Protocol Testing

- 1 Turn on the scale.
- 2 Press  key during that start up ,display will be show “*FD bL*”.
- 3 Press  key until display show “*F2 Coñ*”.
- 4 Press  key to confirm,display will be show “*bL*”
- 5 Press  key to enter,display will be show “*Con 1*”
- 6 Press  key to confirm,display show “*F2 Coñ*”.
- 7 Press  key to select “*bACT*” option.
- 8 Press  key to confirm and back to normal weighing mode.

Testing steps in the mobile phone

- 1 Tab the connect button in your mobile phone to connect the Bluetooth module
- 2 Select the Unknown Service the last but one
- 3 Tab it and turn on the icon,Once set it successfully ,The [▼] indicator above[] Bluetooth indicator in the scale appears.
- 4 Tab logs ,the weighing data will be show

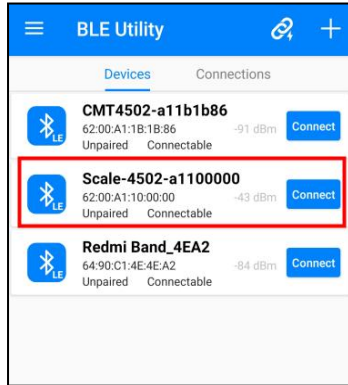

①

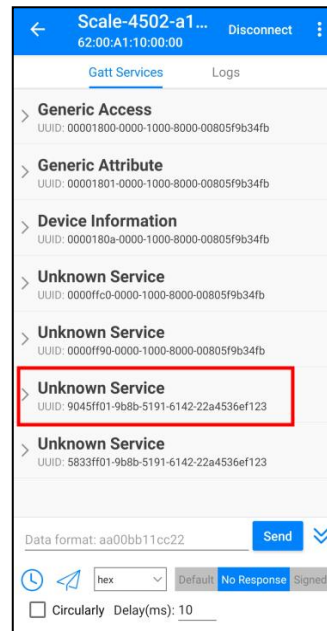

②

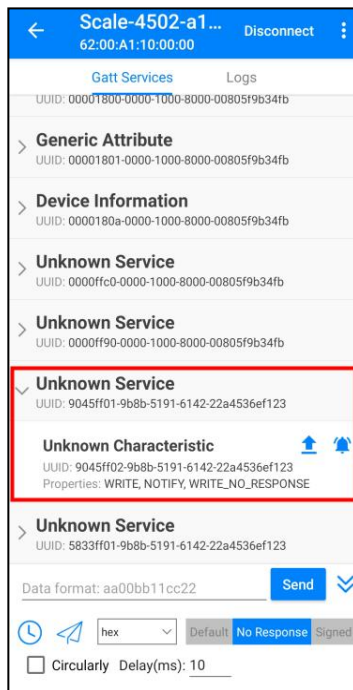



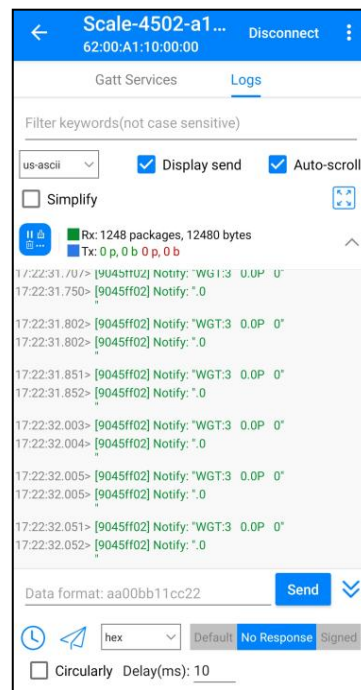





③



④

5.7.3 CON2 Communication Protocol Testing

- 1 Turn on the scale.
- 2 Press  key during that start up ,display will be show “*FD bL*”
- 3 Press  key until display show “*F2 Con*”
- 4 Press  key to confirm,display will be show “*bL*”
- 5 Press  key to enter,display will be show “*Con 1*”
- 6 Press  key to select “*Con 2*”
- 7 Press  key to confirm,display show “*StA*”
- 8 Press  key to confirm
- 9 Press  key to select “*BACK*” option
- 10 Press  key to confirm and back to normal weighing mode.

Testing steps in the mobile phone

- 1 Tab the connect button in your phone to connect the Bluetooth module.
- 2 Select the Unknown Service the last but one .
- 3 Tab it and turn on the icon,Once set it successfully ,The [▼] indicator above ] Bluetooth indicator in the scale appears .
- 4 Tab logs ,the weighing data will be show.

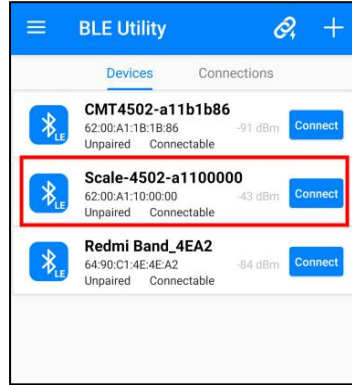

①

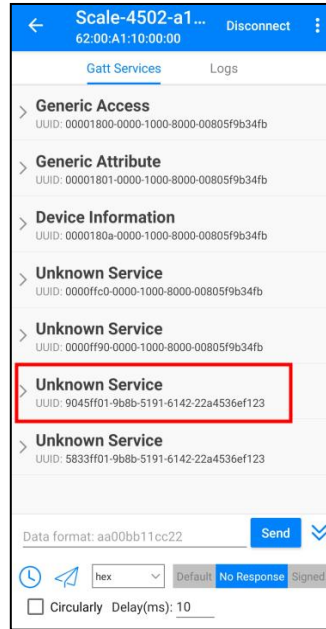

②

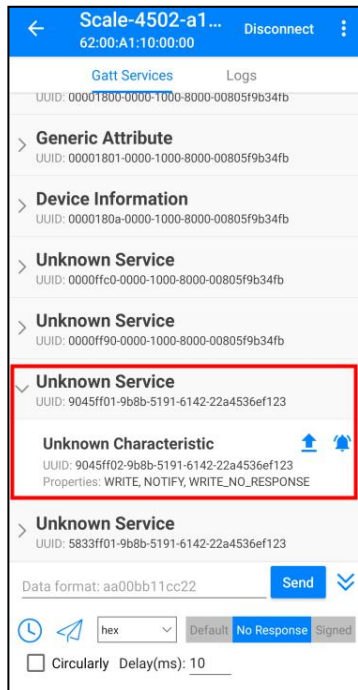



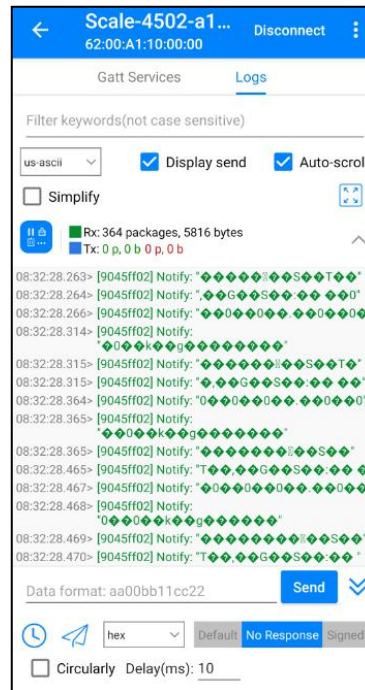





③



④

5.7.4 ASK Command Testing

- 1 Turn on the scale.
- 2 Press  key during that start up ,display will be show “*FD bL*”.
- 3 Press  key until display show “*F2 Coñ*”.
- 4 Press  key to confirm,display will be show “*bL*”
- 5 Press  key to enter,display will be show “*Con I*”
- 6 Press  key until display show “*AST*”
- 7 Press  key to confirm,display show “*F2 Coñ*”.
- 8 Press  key to select “*bACT*” option.
- 9 Press  key to confirm and back to normal weighing mode.

Testing steps in the mobile phone

- 1 Tab the connect button in your phone to connect the Bluetooth module
- 2 Select the Unknown Service the last but one
- 3 Tab it and turn on the icon,Once set it successfully ,The [▼] indicator above[] Bluetooth indicator in the scale appears.
- 4 Tab logs and Entered the Command to receive the corresponding data
Command W: read data
Command TARE: Tare
Command ZERO: Zero

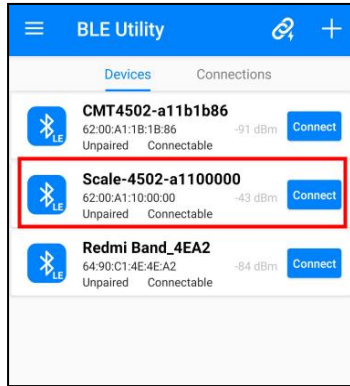

①

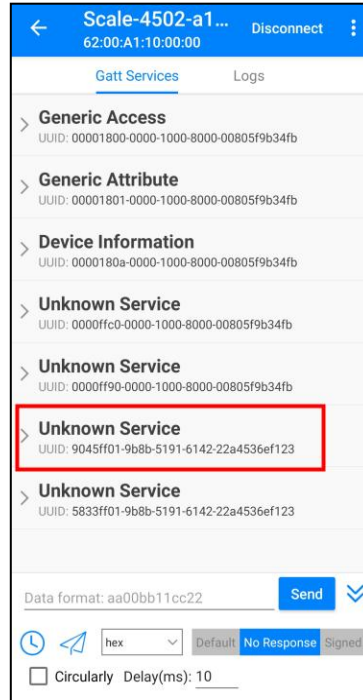

②

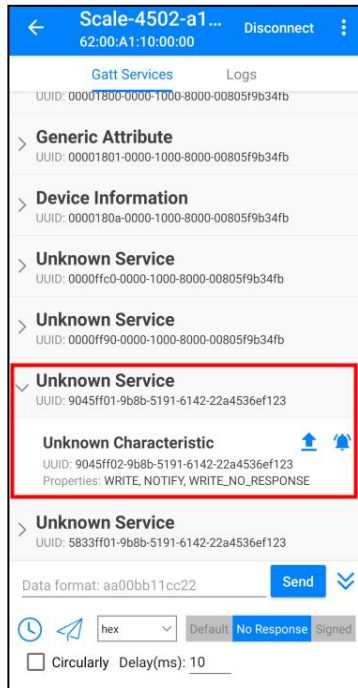



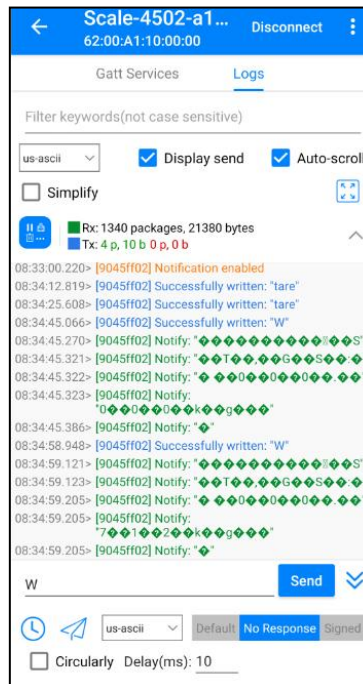







③



④

5.8 POS/ECR protocol selection

- 1 Turn on the scale.
- 2 Press  key during that start up ,display will be show “*FD bL*”
- 3 Press  key until display show “*F2 Coñ*”
- 4 Press  key to confirm,display will be show “*bt*”
- 5 Press  key to select “*Port*” option
- 6 Press  key to confirm,display show “*oFF*”
- 7 Press  key until display show “*CAS 2*”
- 8 Press  key to confirm
- 9 If necessary, Press  key to select protocol from type 0 ~ type 6 (TYPE 0,2,4,5,6)
- 10 Press  key to confirm,display show “*F2 Coñ*”
- 11 Press  key to select “*bACT*” option
- 12 Press  key to confirm and back to normal weighing mode.

6 PARAMETER SETTING

Enter into the Menu

- Press  key during that start up ,display will be shown “*FO 6L*”

Enter to Selected Menu

- Press  , it can confirm which will be shown displayed.

Select the Menu

- Press  key to choose menu block one by one.

Return to Weighing Mode

- Press  key to select “*BACK*” option in parameters to escape from the menu and back to normal weighing mode.

To access the technical parameters F4 TARE & TECH, it's required to press the calibration switch, switch is locating below the scale

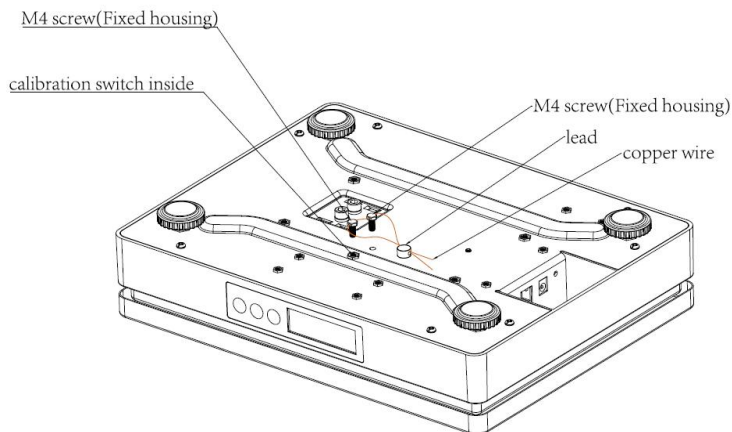

6.1 MENU BLOCK

Menu	Sub-Menu		Description	
F0 bL	oFF		To set backlight function	
	on			
	AUto			
F1 oFF	oFF		Auto off function disable	
	3		Scale will be auto off three minutes later	
	10		Scale will be auto off 10 minutes later	
	30		Scale will be auto off 30 minutes later	
F2 Coñ	bt	Con 1	Continuous Protocol 1	
		Con 2	CoUt	Continuous Protocol 2
			StA	Send stable weighing data
		CAS	ACt	CAS Active Protocol
			PAS	CAS Passive Protocol
		ASt	Ask mode 1) Command W: read data 2) Command TARE: Tare 3) Command ZERO: Zero	
		oFF	Bluetooth Communication port off	
		CAS 2	N.A	
		Port	Con 1	Continuous Protocol 1
			Con 2	CoUt
	StA			Send stable weighing data
	CAS		ACt	CAS Active Protocol
			PAS	CAS Passive Protocol
	ASt		Ask mode 1) Command W: read data 2) Command TARE: Tare 3) Command ZERO: Zero	
	oFF		RS232 Communication port off	
	CAS 2		TYPE 0	CAS POS /ECR protocol
			TYPE 2	
			TYPE 4	
		TYPE 5		
		TYPE 6		
F3 iSn	To show the internal counts			
F4 tArE	oFF	To disable tare function		
	*on	To enable tare function		
tECH	For any approved version, it's required to press the calibration switch			
	APPRou	CPA	CPA approval	
		o iñL	OIML approval	

		<i>nTEP</i>	NTEP approval
		<i>nonE</i>	None approval
		<i>SLSI</i>	SLSI approval
	<i>P1 CAL</i>	<i>CAL FG</i>	Calibration
		<i>CAL Lb</i>	
	<i>P2 RES</i>	<i>3000\3000r\</i> <i>3000\16000</i>	Set external resolution
	<i>P3 CAP</i>	<i>6FG (12 Lb)</i>	Set Scale Capacity
		<i>12FG(30 Lb)</i>	
		<i>30FG(60 Lb)</i>	
	<i>P4 GRA</i>		Set the local gravity
<i>P5 STA</i>	<i>on</i>	Multi-Tare operation enable	
	<i>off</i>	Multi-Tare operation disable	
<i>BACT</i>	Escape from setting menu and back to normal weighing mode		

Note: To calibrate in "kg" or "lb" unit, capacity will be show in kg or lb values.

Default setting is marked by *

7. DIAGRAM: Serial interface

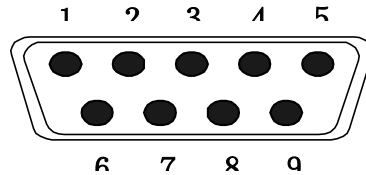

Pin 2	RXD	Input	Receiving data
Pin 3	TXD	Output	Transmission data
Pin 5	GND	—	Signal ground

9pin D Connector:

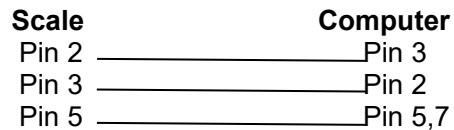

8. SPECIFICATION

MODEL	TPB-12	TPB-30	TPB-60
Maximum Capacity	12 lb / 6 kg / 192 oz	30 lb / 12 kg / 480 oz	60 lb / 30 kg / 960 oz
Minimum Capacity	0.04 lb / 20 g / 1 oz	0.1 lb / 40 g / 2 oz	0.2 lb / 100 g / 4 oz
Readability	0.002 lb/0.001 kg/0.05 oz	0.005 lb/0.002 kg / 0.1 oz	0.01 lb / 0.005 kg / 0.2 oz
Max. Divisions	1/6000		
Weighing Units	kg/lb/oz		
Front Display	0.59inch /15mm digits LCD Display with white LED back Light		
Platter size	13.6 x 10.4 inch / 343 x 263mm		
Housing	Plastic housing (steel base) with stainless steel pan		
Interface	RS232 Output standard		
Operation Temperature	14°F - 104°F / -10°C - + 40°C		
Power	Input AC 100-240V, output DC 12V/500mA 6V/3.2Ah rechargeable battery		
Battery life	Approx. 48 hours with Bluetooth and backlight of continuous use Approx. 52 hours with Bluetooth or backlight of continuous use Approx. 68 hours without Bluetooth or backlight of continuous use		
Keypad	3 membrane keys		
Dimensions (inch/mm)	13.6 (W) x 10.4 (D) x 3.4 (H) / 345 (W) x 265 (D) x 86 (H)		
Net weight	9.7 lb (4.4 kg)		
Gross weight	11.0 lb (5.0 kg)		
Approvals	NTEP: Certificate No.22-010		

9. DIMMENSIONS(inch/mm)

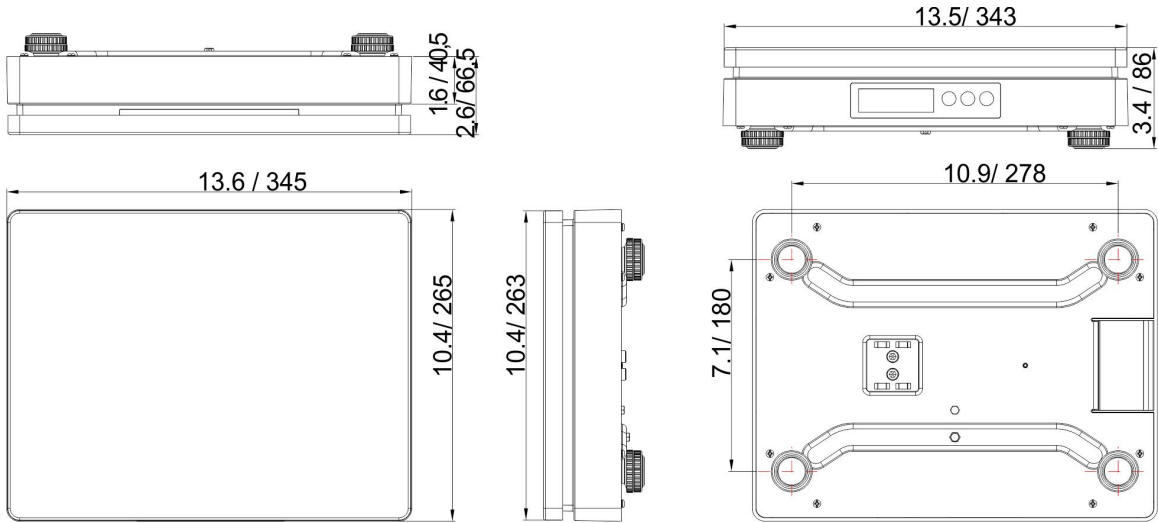

10.ERROR MESSAGE

Error Message	Description	Solution
<i>Err 4</i>	Zero setting error	Zero setting range exceeded due to switching on.(4%max) Make sure platform empty.
<i>Err 5</i>	A/D value out of range	Make sure platform empty and check the pan is installed proper. Check the load cell connectors.
<i>--oL--</i>	Over range	Remove the load. Re calibrate
<i>FA iL</i>	Calibration Error	Check the calibration weight and re calibrate

VISIONTECH
SHOP www.VisionTechShop.com

100 Temple Ave. Hackensack, NJ 07601

Tel:+ 1-201-679-7793