

**VISION**TECH  
SHOP

# Operation Manual

**TBW**  
**Bench Scales**

## Contents







1. INTRODUCTION.....	1
2. KEY DESCRIPTIONS.....	1
2.1 Second fuctions of the keys.....	1
3. DISPLAY SYMBOLS.....	2
4. BASIC OPERATION.....	2
4.1 Power On/Off.....	2
4.2 Zero.....	2
4.3 Tare.....	2
4.4 Select Unit and Sampling operation.....	3
5. CHECK WEIGHING.....	3
5.1. Set Limits.....	3
5.2. Set Check Weighing.....	3
6. ACCUMULATION.....	4
6.1. Memory Recall.....	4
6.2. Memory Clear.....	4
6.3. Automatically accumulation.....	4
7. PARTS COUNTING.....	5
8. ANIMAL WEIGHING.....	5
9. KEYBOARD LOCK.....	6
10. SET AUTO POWER OFF.....	6
11. SET BACK LIGHT.....	6
12. SPECIFICATION.....	7
13. DIMENSIONS (INCH/MM).....	7
14. ERROR MESSAGE.....	8
15. RS232 OUT PUT.....	8









## 1. INTRODUCTION

- ✓ The TBW series platform scales that amplifies signals from a load cell, converts it to digital data and displays it as a mass value.
- ✓ It is suitable for general weighing or more specialized applications such as check weighing, animal weighing and accumulation applications.
- ✓ It can connect the indicator to a printer or a PC.
- ✓ Large LCD with white LED back light displays

## 2. KEY DESCRIPTIONS

Keys	Description
	Power turn ON/OFF
	Set the Zero Display
	To perform a tare function, Subtracts weights.
	Accumulator key, current values will store to the memory, To send the data to printer or PC
	Shift to Gross / Net Weight.
	Counting
	To change the unit

### 2.1 Second functions of the keys

Function	Keys
To confirm the selected menu	
To change the menu and to increase the active digit	
To move the active digit to right	
To move the active digit to left	
To enter the menu	
Escape from the menu to normal operation.	

### 3. DISPLAY SYMBOLS

Display	Description
STABLE	Indicate when the scale is stable
ZERO	Indicate when the scale in Zero
TARE	Indicate when the scale in Tare
NET	Indicate when the scale in Net mode.
GROSS	Indicate when the scale in Gross mode
kg	Indicate when the scale in Kilogram (kg) unit
pcs	Indicate when the scale in counting
%	Indicate when the scale in percent
	Indicate when the battery charge is getting low
Hold	Indicate when the scale in Hold mode
Auto	Indicate when the scale in Auto

### 4. BASIC OPERATION

#### 4.1 Power On/Off:

Switch on the balance by pressing on/ off key.

The display is switched on and the test is started and if want to switch off, press the key again.



#### 4.2 Zero

Environmental conditions can lead to the balance exactly zero despite the platform not taking any strain. However, you can set the display of your balance to

zero any time by pressing  key and therefore ensure that the weighing starts at zero.

#### 4.3 Tare

The weight of any container can be tared by pressing  button so that with subsequent weighing the net weight of the object being weighed is always displayed.

- Load weight on the platform.
- Press  key. Zero is displayed, and tare is subtracted.
- Remove weight on the platform. Tared weight is displayed. It can set only one tare value. It will be shown with a minus value.
- Press G/N to change between gross weight and net weight.
- To clear the tare value, remove the load and press  key. Zero is displayed, tare weight is cleared.

#### 4.4 Select Unit and Sampling operation













Press  key, it can change unit and sampling operation.

### 5. CHECK WEIGHING





It can set an upper or lower limit when weighing with limit range.

During the limit controls dividing the unit will indicate whether a value upper or lower limits with an alarm sound.

#### 5.1. Set Limits

- Press  and  key together, display will be show **set h**.
- Press  key to select **set h** or **set l**
- Press  key to confirm, display will show **00000** and will blink the last digit.
- Enter the high limit value by using  and  keys to change the active digits and press  key to increase the value.
- Press  key to confirm, display will show **set l**
- Enter the high limit value by using  and  keys to change the active digits and press  key to increment the value.
- Press  key to confirm.
- To escape from the settings press  key.

#### 5.2. Set Check Weighing

- Press  and  key together, display will show **set h**.
- Press  key to select display **beep**.
- Press  key to confirm, display will show **none** or **ok** or **ng**
- **Check mode none:** No beep sound in the limits. Function turned off.
- **Check mode ok:** When the weight is between the limits. OK will be shown and beeper will be sounded.
- **Check mode ng:** When the weight is out of the limits, the beeper will be sounded, and Ok will be shown.

**Note: Check weighing available only when weight more than 20d.**

## 6. ACCUMULATION

The scale can be set to accumulate manually by pressing  key. For settings, see the parameter **p 1 Com » mode » pr 2**

Before operation scale should be stable and return to zero, accumulation available only when weight more than 20d

### Accumulation Operation

- Place the load on the platform.
- Press  key, when displayed STABLE indication.
- Display will be show **acc 1** then will be show the total saved value. These displays will be shown only three seconds.
- Remove the weight from the pan.
- When display get zero and stable then place the second weight.
- It can continue until the memory gets fully or 99 items.

### 6.1. Memory Recall

To recall the memory press  key when there is no load on the platform. Display will show **acc X** (X: Total number of accumulation) then will show the total saved value. These displays will only be shown for three seconds.

### 6.2. Memory Clear

To clear the memory, press  and  keys together.

Display will be show **Acc 0**, all accumulation memory cleared from the memory.

### 6.3. Automatically accumulation.

The scale can be set to accumulate automatically. For settings, see the parameter **p 1 Com » mode » auto**

### Automatic Accumulation Operation

- Place the load on the platform.
- When display gets STABLE indication, display will show **acc 1**, then will be show the total saved value. These displays will be shown only three seconds.
- Remove the weight from the platform.
- When display is zero and stable then place the second weight.
- It can continue until the memory gets full or 99 items.

## 7. PARTS COUNTING

To enter the parts counting, press  key and select until display shows **p 10**

Press  to change the parts quantity.

Options: **p10 / p20 / p50 / p100 / p200**











### Parts Counting Operation

- Place the load on the platform
- Select the parts quantity as per the option
- Choose from option depending on how many pieces/items are on the scale
- Press  key to confirm, display will be shown ---- then will show the quantity
- Then can add goods on the platform, display will update the parts quantity automatically

Press  key go back to the weighing mode.

## 8. ANIMAL WEIGHING

TBW can use for vibrate loads weigh. This function can use for animal weighing. For settings, see the parameter *P 3 oth » Ann*

- 1 Press  key during the self checking.
- 2 Display show PN, in succession press ,  and  to enter.
- 3 Display will be show **p 0 chk.**
- 4 Press  key until display show **p 3 oth.**
- 5 Press  key to confirm.
- 6 Press  key to select ON/OFF.
- 7 Press  key to confirm.
- 8 Press  key twice to back to normal weighing mode and scale will start self-checking.
- 9 Press  &  key together to enter animal weighing mode ,the HOLD indicator will be on
- 10 Bring the load on the platform, display will be show the reading
- 11 It can add or remove loads also update the weighing values.
- 12 To complete the current weighing, remove the weight from the platform.





- 13 To exit animal mode ,Press  &  key together again
- 14 To disable the animal weighing function, set the parameter *P 3 oth » Anñ » off*

### 9. KEYBOARD LOCK





It can set lock keyboard, for settings, see the parameter *p 3 oth » lock*

When the keys are not using within 10 minutes, the keys will be lock automatically. After entering the lock function, when we press the keys display will be show **k-lok**. Then will come to normal display.

If want to unlock and want to use the keys press and hold ,  and  keys three seconds. Display will be show **u lck** Then will come to normal display

### 10. SET AUTO POWER OFF

It can set auto power of the scale - when scale not in use, scale will turn off after a set time.



- Hold  key three seconds display will show **setbl**
- Press  key to change **Set of** and press  key to confirm
- Press  key to change the options.

<b>Set of</b>	<b>off</b>	To set auto off function turn off, for scale always on
	<b>Of 5</b>	Set to turn off five minutes later
	<b>Of 15</b>	Set to turn off fifteen minutes later

- After selecting the auto off option press  key to confirm and press  key to escape from the settings.

### 11. SET BACK LIGHT

It can set back light when scale in use.

- Hold  key three seconds display will show **setbl**
- Press  key to confirm

<b>setbl</b>	<b>au</b>	To set auto option. When start to use back light will be on and when stop the operation back light also will off.
	<b>on</b>	To set always on. After turning on the power, back light also will be on.
	<b>off</b>	To set back light turn off. No back light in the operations

- After selecting the backlight option press  key to confirm and press  key to escape from the settings.

## 12. SPECIFICATION

Model	TBW-100	TBW-200	TBW-500
Capacity	100 lb / 50 kg	200 lb / 100 kg	500 lb / 250 kg
Resolution	1/5000		
Readability	0.02 lb / 0.01 kg	0.05 lb / 0.02 kg	0.1 lb / 0.05 kg
Housing	ABS plastic		
Weighing units	kg / lb		
Operating Temperature	14°F - 104°F / -10°C - 40°C		
Display	2.05inch / 52mm LCD		
Key Pad	7 Keys		
Power	AC (110V/60Hz)/ Battery (6V/4Ah)		
Calibration	Automatic External		
Interface	RS-232 Output		
Load cell drive Voltage	Max: 5V/150mA		
Load Cells	Up to 4 load cell		
ADC	Sigma Delta		
ADC Update	≤1/10 second		
Stabilization Time	One seconds typical		
Gross Weight	40.3 lb (18.3 kg)		

## 13. DIMENSIONS (INCH/MM)

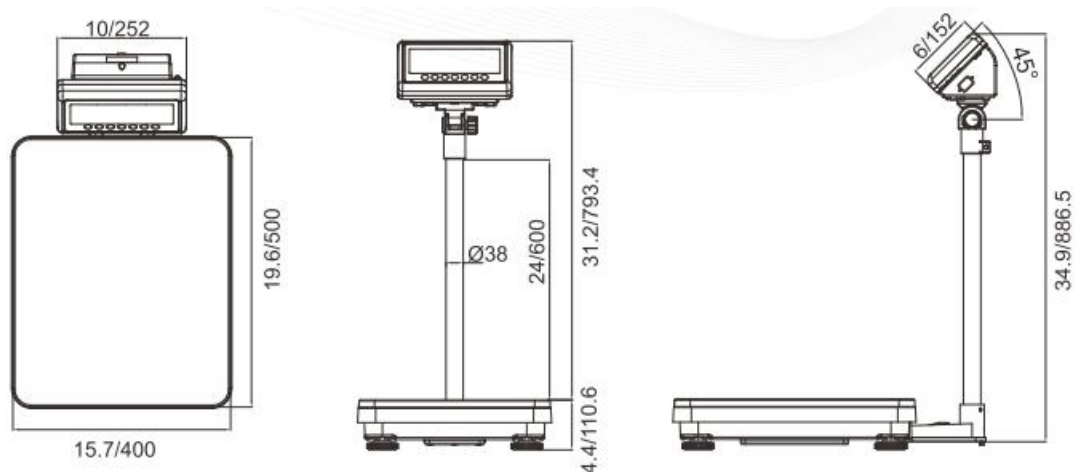

### 14. ERROR MESSAGE

Error Message	Description	Solution
-----	Maximum load exceeded	Unload or reduce weight
Err 1	Incorrect date	Enter the date by using format "yy;mm:dd"
Err 2	Incorrect time	Enter the time by using format "hh:mm:ss"
Err 4	Zero setting error	Zero setting range exceeded due to switching on (4%max) Make sure platform empty.
Err 5	Key board error	Check the keys and connecter.
Err 6	A/D value out of range	Make sure platform empty and check the pan is installed proper. Check the load cell connectors.
Err I	Approval setting error	Check the PCB jumper settings. Must be connect jumper pin to K1 (TBW series)
--ol--	Over range	Remove the load. Re calibrate
--lo--	Underload	Minus weight, check the platform and restart or calibrate.

### 15. RS232 OUT PUT

The TBW series of scales can be ordered with a standard RS-232 output. It can be connected to DEP-50 receipt printer & DLP-50 label printer.

#### 15.1 Print Format

<div style="border: 1px solid gray; padding: 5px; width: fit-content; margin: 0 auto;"> <p><b>THANK YOU</b></p> <p>Weight: <b>1.745 lb</b></p> <p>MAR. 05. 2021 07:42:48</p> </div> <p>Label Format</p>	<div style="border: 1px solid gray; padding: 5px; width: fit-content; margin: 0 auto;"> <pre> ----- 1  1.100 lb 2  1.100 lb 3  1.105 lb 4  1.100 lb 5  1.100 lb 6  1.100 lb ----- TOTAL : 6.605 lb COUNT : 6 -----                     </pre> </div> <p>Receipt Format # 1</p>	<div style="border: 1px solid gray; padding: 5px; width: fit-content; margin: 0 auto;"> <pre> Gross : 0.500 lb Tare  : 0.000 lb Net   : 0.500 lb  Gross : 0.106 lb Tare  : 0.000 lb Net   : 0.106 lb  Gross : 0.606 lb Tare  : 0.106 lb Net   : 0.500 lb  ----- TOTAL : 1.106 lb -----                     </pre> </div> <p>Receipt Format # 2</p>
---	--	--

15.2 Diagram: Serial interface, RS-232 (9pin D type connector)

Pin 2	RXD	Input	Receiving data
Pin 3	TXD	Output	Transmission data
Pin 5	GND	—	Signal ground

**9pin D Connector:**

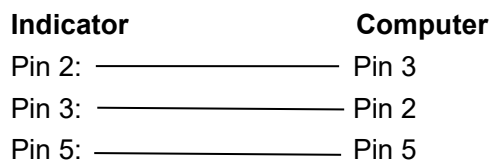

**VISION**<sup>TECH</sup>  
SHOP [www.visiontechshop.com](http://www.visiontechshop.com)

100 Temple Ave. Hackensack, NJ 07601  
Tel: + 1-201-679-7793