

Operating manual

Model : PW-200

US V1.0

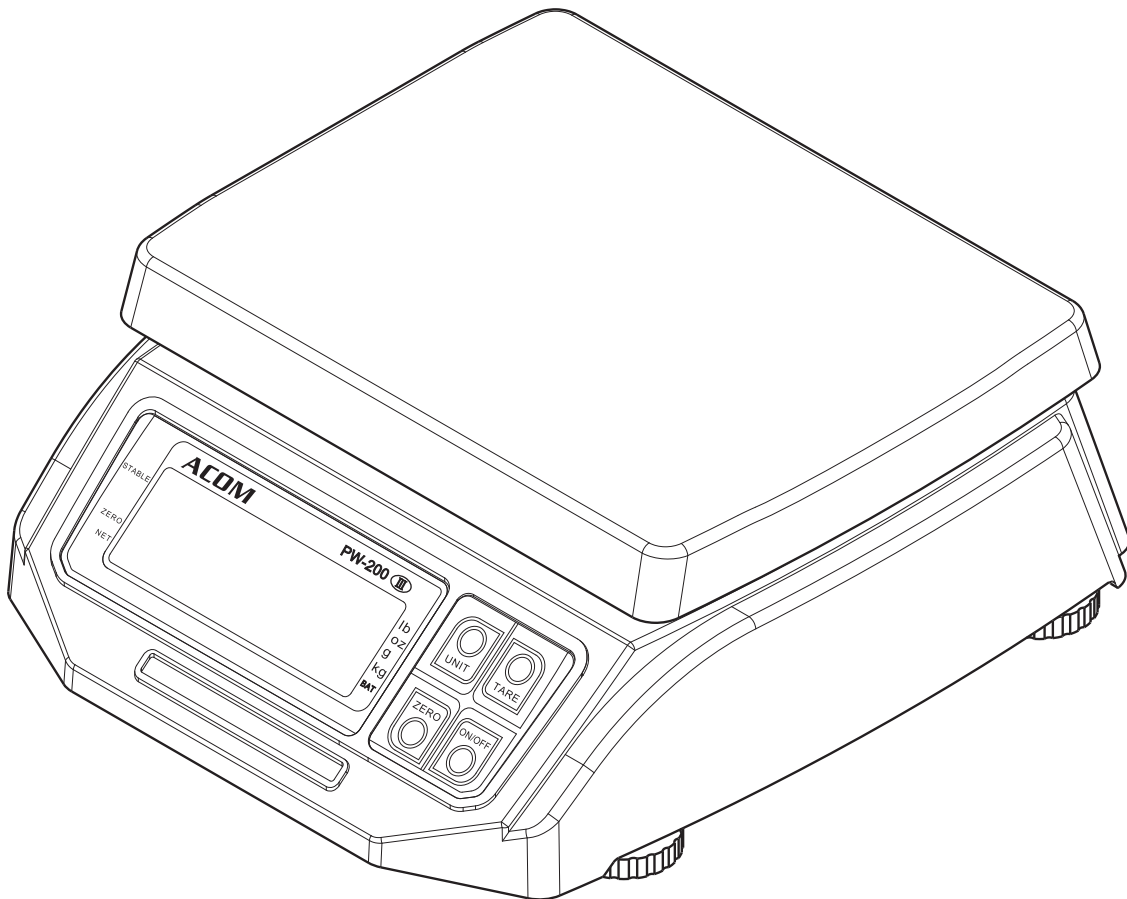

ACOM

PRECAUTIONS



Please be aware before use the scales to avoid any danger and damages.

* Object can be modified without notice

● Extreme caution

	Might can get serious damage.
-----------------------------------------------------------------------------------	-------------------------------

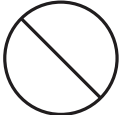
● Content of sign

 Prohibition	Never do.
	Disassemble is not allowed.
	Must follow the steps

Warning

Make the bubble position to the middle of level gauge.

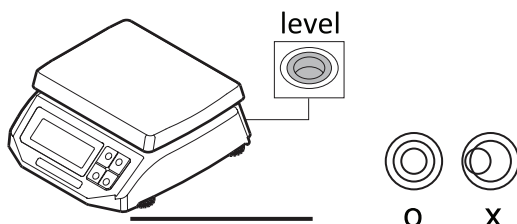

Avoid any liquid which including thinner or alcohol when clean up the scale.

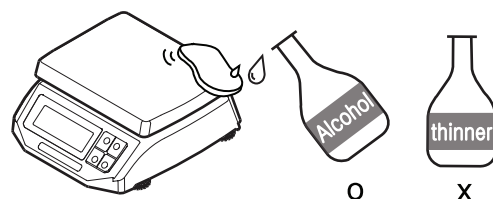

- Please keep the follow things.

Extreme cautions

Be careful not to damage the power cable.
(Can bring electric shock or fire)

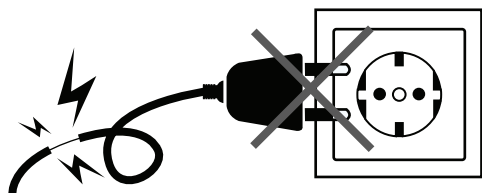

Do not convert by your self.
(Scale can be damaged)



Do not touch the switch with wet hands.

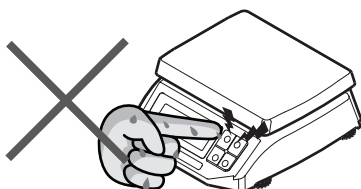

Make sure not to get wet.
(May can be the reasons for electric shock, and scale damaged.)

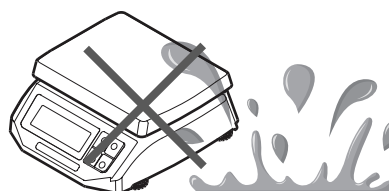

Cautions

Place the scale where wind free and vibration free.

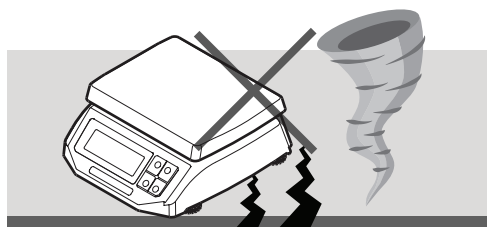

Place the scale where direct light free.

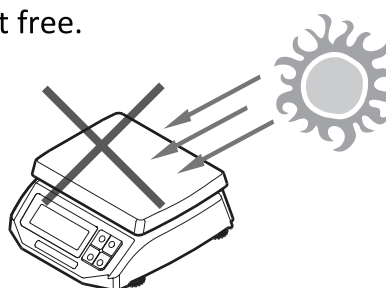

Place the scale for from high electric wave.

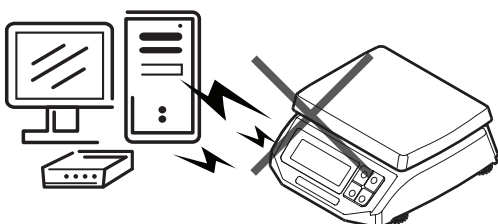

Please avoid to give sudden impact on the scale tray.



Preface

Acom Inc. would like to thank you for purchasing ACOM product model name PW-200 simple weighing scale. We are committed to create the high quality and low maintenance required products to supply ACOM customers with diligent customer services.

Specification

Model	PW-200(6)	PW-200(15)	PW-200(30)	PW-200(60)
Maximum capacity	6 lb	15 lb	30 lb	60 lb
Minimum graduation	0.002 lb	0.005 lb	0.01 lb	0.02 lb
Maximum tare weight	- 6 lb	- 15 lb	- 30 lb	- 60 lb
Auxiliary Capacities	96 x 0.05 oz 3,000 x 1 g 3 x 0.001 kg	240 x 0.1 oz 6,000 x 2 g 6 x 0.002 kg	480 x 0.2 oz 15,000 x 5 g 15 x 0.005 kg	960 x 0.5 oz 30,000 x 10 g 30 x 0.01 kg
A/D conversion speed	10 Updates / SEC			
Internal resolution	1 / 60,000			
Display type	LCD display			
Power source	D size battery 1.5V x 4EA(6V) , 9V/300mA DC Adaptor			
Operating time	Alkaline Battery : 2500 hr			
Operating temp	-10°C ~ 40°C / 14°F ~ 104°C			
Keys	UNIT, TARE, ZERO, ON/OFF			
Communication	RS-232C			
Power consumption	0.05 Watt			
Stainless weighing pan (in/mm)	(W)11.81 x (D)10.43 / (W)300 x (D)265			
Product size (in/mm)	(W)9.64 x (D)10.86 x (H)4.33 / (W)245 x (D)276 x (H)110			
Product weight	5.51 lbs / 2.5 kg			
Option	RS-232C interface , Customer(Rear) Display			

Installation and precaution

- ※ PLACE THE SCALE ON THE FLAT AND RIGID SITE WHERE FREE OF VIBRATIONS.
- ※ PLEASE AVOID THE RADIO DEVICES WHICH EMITS STRONG ELECTROMAGNETIC FIELDS NEAR BY TO INSTALL.
- ※ DO NOT APPLY SUDDEN IMPACT ONTO THE WEIGHING PAN.
- ※ DO NOT SPILL THE WATER TO THE SCALE.
- ※ DO NOT USE CLEANERS INCLUDE SOLVENT OR SINNER.
- ※ THIS PRODUCT HAVE TO GET THE PERIODIC INSPECTION OBLIGATORILY, PLEASE MAKE A PROOFREADING PERIODICALLY.

Name for each parts

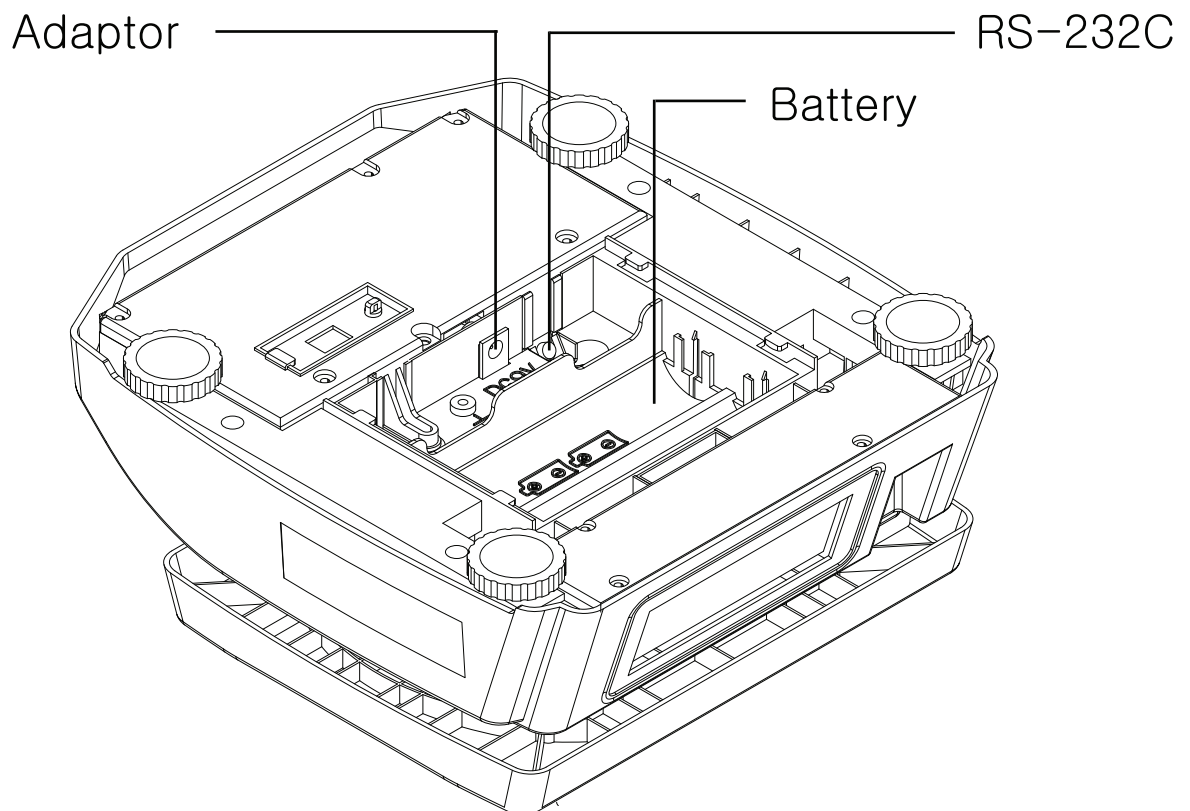
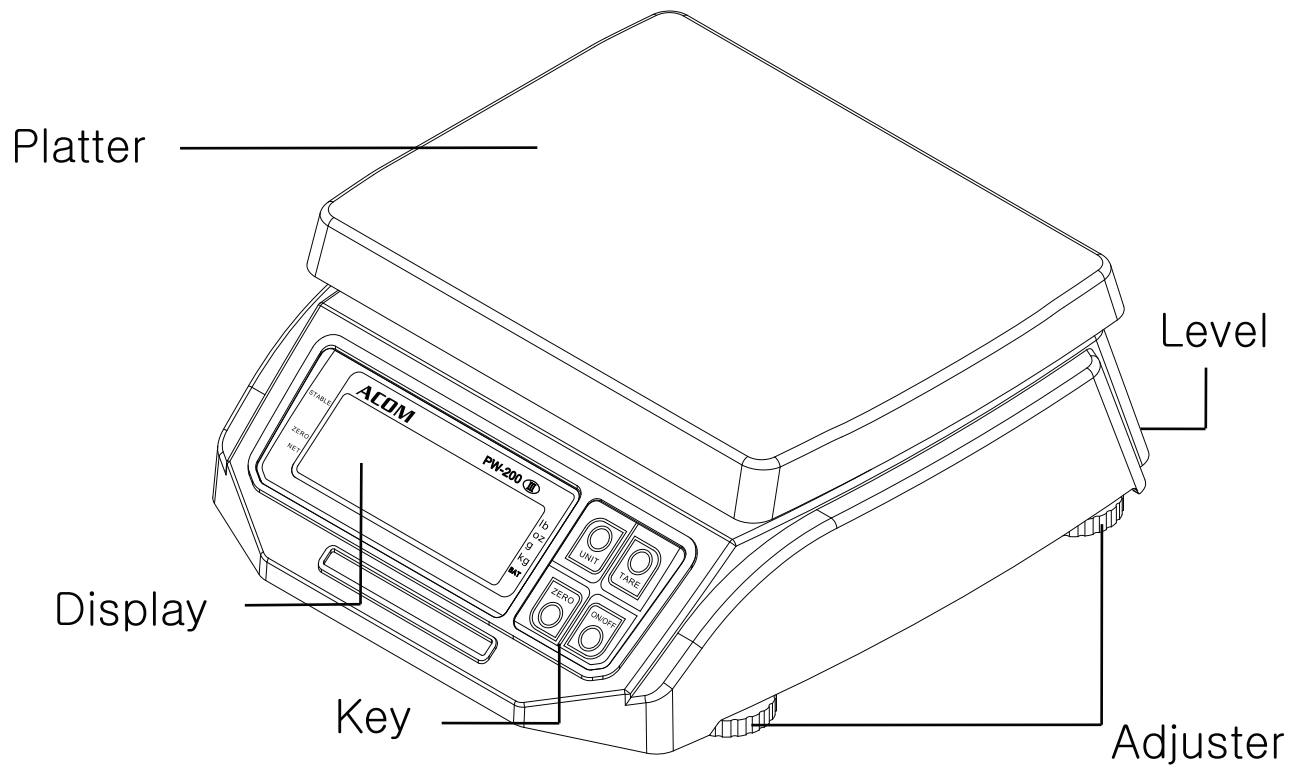

Key & Function

※ DISPLAY & KEYBOARD

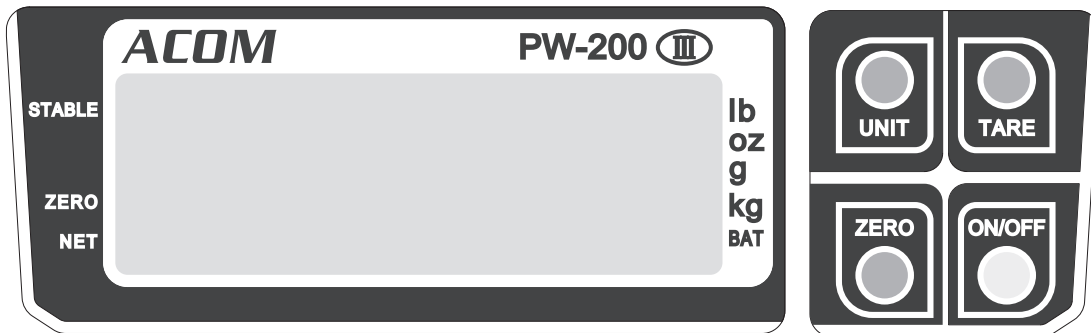

※ FUNCTION



Power : ON/OFF



UNIT : This key is used to convert the unit of weight
lb → oz → g → kg → lb



This key is used to set the tare or delete the tare
*Tare = A container



This key is used to correct the weight to zero

The designators

Designators	Meaning
ZERO	It designates the weight is zero
STABLE	It designates the weight is stable
NET	It designates the tare set
Bat	It designates when the battery need to be changed
lb	It designates unit of weight is pound
oz	It designates unit of weight is ounce
g	It designates unit of weight is gram
kg	It designates unit of weight is kilogram

How to use

1. General weighing

Please check the designators that "ZERO" and "STABLE" before weighing

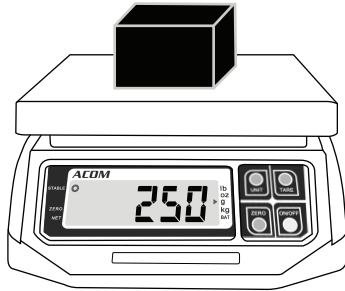

- ① Put the goods on the weighing pan
- ② Read the correct value after the "STABLE" sign turned on

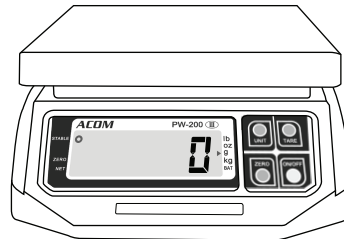

- ③ Remove the goods on the weighing pan

2. Weighing with TARE function



- ① Place the tare on the weighing pan

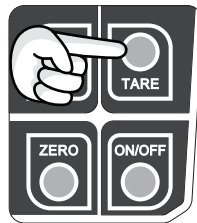

- ② Press the "TARE" key, then weight will be "0" and the designator NET will be turned on



- ③ Put the goods on the tare (A container)
Read the correct value after the "STABLE" sign turned on

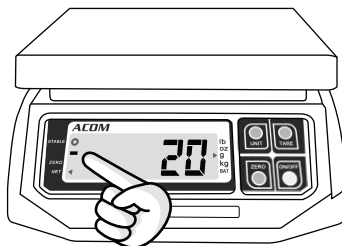

- ④ Remove the tare (A container) and goods, then the display will show the weight of the tare with "-" sign

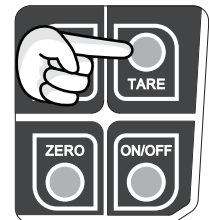

- ⑤ If you do not want to use the tare then press "TARE" key then the sign of tare will be turned off

3. Converting unit of weight

You can select one of lb, oz, g and kg by “UNIT” key. (Default setting is lb)

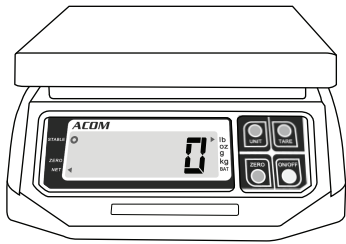

① Turn on the scale

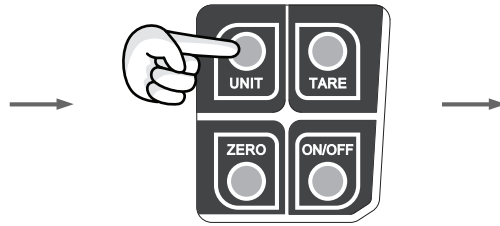

② Press “UNIT” key

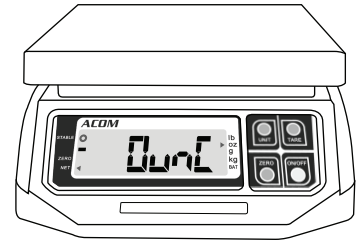

③ Display shows lb, oz, g and kg, please select by “UNIT” key

- Display -

lb : **Lb**

oz : **0.00**

g : **0.00**

kg : **0.00**

* A current unit of weight is saved automatically into the memory.

4. Error table

ERROR	Meaning	Solution	
Zero	Zero initializing failure	Remove the weight on the weighing pan then restart the scale	Otherwise, call the service
EEP	Memory IC error of the circuit	Call the service	
AdC	Analogue circuit error	Call the service	
PARA	Memory loading failure	Call the service	

How to set the user parameter

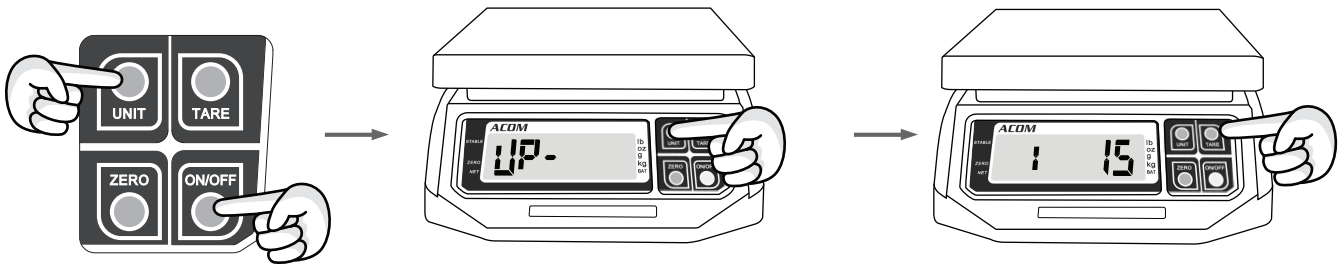

- ① Turn on the scale while “UNIT” key is being pressed.
- ② Press “UNIT” key.
- ③ In this mode, “UNIT” key acts as Enter, “TARE” key acts as Inc(Increment), “ZERO” key acts as Shift.

1. Display, Function

	Value	Function explanation
UP-1	05	Count down → battery voltage → weighing mode
	25	Count down → weighing mode

2. Off time

	Value	Function explanation	Value	Function explanation
UP-2	x0	No off	x5	5 min
	x1	15 sec	x6	10 min
	x2	30 sec	x7	20 min
	x3	1 min	x8	30 min
	x4	2 min		

3. RS-232C mode

	Value	Function explanation
UP-3	21	Hand shake mode, Baudrate : 9600 bps (default setting)
	01	Stream mode at stable, Baudrate : 9600 bps
	11	Stream mode at every A/D conversion, Baudrate : 9600 bps

4. RS-232C protocols 0~6, Contact your dealer for more information.

ACOM

ACOM Inc.

15th, 101 YUGYO-RO, GUNNAE-MYUN, POCHON-SI, GYEONGGI-DO
KOREA POSTAL CODE 11157

<http://www.acominc.co.kr>

Copyright 2018. All rights reserved.