



HK-SYSTEMS HK-7200 Series Electronic Cash Register

Operating and Programming Manual



All specifications are subject to change without notice.
HK-7200 Series Manual v1.1

ATTENTION

The product that you have purchased contains a rechargeable Lithium battery. This battery is recyclable. At the end of its useful life, under various state and local laws, it may be illegal to dispose of the battery into the municipal waste system.

Check with your local solid waste officials for details concerning recycling options or proper disposal.

WARNING

This is a Class A product. In a domestic environment this product may cause radio interference in which case the user may be required to take adequate measures.



NOTE

The socket outlet shall be installed near the equipment and shall be easily accessible.

Precaution Statements

Follow these safety, servicing and ESD precautions to prevent damage and to protect against potential hazards such as electrical shock.

1-1 Safety Precautions

1. Be sure that all built-in protective devices are replaced. Restore any missing protective shields.
2. When reinstalling the chassis and its assemblies, be sure to restore all protective devices, including nonmetallic control knobs and compartment covers.
3. Make sure there are no cabinet openings through which people - particularly children - might insert fingers and contact dangerous voltages. Such openings include excessively wide cabinet ventilation slots and improperly fitted covers and drawers.
4. Design Alteration Warning:
Never alter or add to the mechanical or electrical design of the ECR. Unauthorized alterations might create a safety hazard. Also, any design changes or additions will void the manufacturer's warranty.
5. Components, parts and wiring that appear to have overheated or that are otherwise damaged should be replaced with parts that meet the original specifications. Always determine the cause of damage or over- heating, and correct any potential hazards.
6. Observe the original lead dress, especially near the following areas: sharp edges, and especially the AC and high voltage supplies. Always inspect for pinched, out-of-place, or frayed wiring. Do not change the spacing between components and the printed circuit board. Check the AC power cord for damage. Make sure that leads and components do not touch thermally hot parts.
7. Product Safety Notice:
Some electrical and mechanical parts have special safety-related characteristics that might not be obvious from visual inspection. These safety features and the protection they give might be lost if the replacement component differs from the original - even if the replacement is rated for higher voltage, wattage, etc.
Components that are critical for safety are indicated in the circuit diagram by shading, () or (). Use replacement components that have the same ratings, especially for flame resistance and dielectric strength specifications. A replacement part that does not have the same safety characteristics as the original might create shock, fire or other hazards.

CAUTION

Danger of explosion if battery is incorrectly replaced. Replace only with the same or equivalent type recommended by the manufacturer. Dispose used batteries according to the manufacturer's instructions.

ATTENTION

Il y a danger d'explosion s'il y a remplacement incorrect de la batterie. Remplacer uniquement avec une batterie du même type ou d'un type équivalent recommandé par le constructeur. Mettre au rebut les batteries usagées conformément aux instructions du fabricant.

1-2 Servicing Precautions

WARNING: First read the-Safety Precautions-section of this manual. If some unforeseen circumstance creates a conflict between the servicing and safety precautions, always follow the safety precautions.

WARNING: An electrolytic capacitor installed with the wrong polarity might explode.

1. Servicing precautions are printed on the cabinet. Follow them.
2. Always unplug the units AC power cord from the AC power source before attempting to:
 - (a) Remove or reinstall any component or assembly
 - (b) Disconnect an electrical plug or connector
 - (c) Connect a test component in parallel with an electrolytic capacitor
3. Some components are raised above the printed circuit board for safety. An insulation tube or tape is sometimes used. The internal wiring is sometimes clamped to prevent contact with thermally hot components. Reinstall all such elements to their original position.
4. After servicing, always check that the screws, components and wiring have been correctly reinstalled. Make sure that the portion around the serviced part has not been damaged.
5. Check the insulation between the blades of the AC plug and accessible conductive parts (examples : metal panels and input terminals).
6. Insulation Checking Procedure: Disconnect the power cord from the AC source and turn the power switch ON. Connect an insulation resistance meter (500V) to the blades of AC plug. The insulation resistance between each blade of the AC plug and accessible conductive parts (see above) should be greater than 1 megohm.
7. Never defeat any of the B+ voltage interlocks. Do not apply AC power to the unit (or any of its assemblies) unless all solid-state heat sinks are correctly installed.
8. Always connect an instrument's ground lead to the instrument chassis ground before connecting the positive lead ; always remove the instrument's ground lead last.

1-3 Precautions for Electrostatically Sensitive Devices (ESDs)

1. Some semiconductor (solid state) devices are easily damaged by static electricity. Such components are called Electrostatically Sensitive Devices (ESDs); examples include integrated circuits and some field-effect transistors. The following techniques will reduce the occurrence of component damage caused by static electricity.
2. Immediately before handling any semiconductor components or assemblies, drain the electrostatic charge from your body by touching a known earth ground. Alternatively, wear a discharging wrist-strap device. (Be sure to remove it prior to applying power - this is an electric shock precaution.)
3. After removing an ESD-equipped assembly, place it on a conductive surface such as aluminum foil to prevent accumulation of electrostatic charge.
4. Do not use freon-propelled chemicals. These can generate electrical charges that damage ESDs.
5. Use only a grounded-tip soldering iron when soldering or unsoldering ESDs.
6. Use only an anti-static solder removal device. Many solder removal devices are not rated as anti-static; these can accumulate sufficient electrical charge to damage ESDs.
7. Do not remove a replacement ESD from its protective package until you are ready to install it. Most replacement ESDs are packaged with leads that are electrically shorted together by conductive foam, aluminum foil or other conductive materials.
8. Immediately before removing the protective material from the leads of a replacement ESD, touch the protective material to the chassis or circuit assembly into which the device will be installed.
9. Minimize body motions when handling unpackaged replacement ESDs. Motions such as brushing clothes together, or lifting a foot from a carpeted floor can generate enough static electricity to damage an ESD.

Contents

- Contents** **5**

- Introduction** **11**
 - About the HK-7200 Series..... 11
 - Using This Manual 12
 - Using Flowcharts..... 12
 - Identifying Components & Connections..... 13
 - Display..... 16
 - Graphic Blue Backlit LCD 16
 - Printer/Printers 19
 - Control Lock..... 20
 - Keyboards 21
 - HK-7200 Flat Keyboard Versions 21
 - HK-7240 Raised Keyboard Versions 21
 - HK-7215 Raised Keyboard Versions 22
 - Initial Clear 23

- Getting Started** **24**
 - Quick Start Steps 24
 - Steps In this chapter: 24
 - Unpacking..... 24
 - Installing the Paper 25
 - Clearing Memory..... 26

- Operations** **28**
 - Introduction 28
 - Overview 28
 - Function key Descriptions 29
 - Clerk Operations..... 33
 - Clerk Sign On Instructions 33
 - Clerk Sign Off Instructions 33
 - Item Registrations 34
 - Keyboard PLU Entries 34
 - Open Keyboard PLU Entry 34
 - Preset Price Keyboard PLU 35
 - Gallonage PLU Entry 35
 - Keyboard PLU Repeat Entry 36
 - Keyboard PLU Multiplication 36
 - Keyboard PLU Multiplication with Decimal Point 37

Split Pricing (Keyboard PLU)	37
Single Item Keyboard PLU	38
Open Code Entry PLU.....	38
Preset Price Code Entry PLU	39
Code Entry PLU Multiplication	39
Code Entry PLU Multiplication with Decimal Point.....	39
Split Pricing Code Entry PLU	40
PLU Price Inquiry	40
Modifier Key	41
Price Level Key	42
Promo	43
Waste	43
Shifting or Exempting Tax	44
Shifting Tax	44
Exempting Tax	45
Percent Key Operations	47
Preset Percent Discount on an Item.....	47
Enter a Percent Discount on an Item	47
Percent on Sale Total.....	48
Coupon on Sale (Vendor Coupon)	48
Coupon on Item (Store Coupon)	49
Return Merchandise Registrations	49
Voids and Corrections	50
Error Correction (Void Last Item).....	50
Void Previous Item.....	50
Cancel.....	51
VOID MODE Operations.....	51
No Sale Operations	52
Open Drawer	52
Non Add Number	52
Received On Account Operations.....	53
Paid Out Operations.....	54
Subtotaling a Sale	54
Eat-In, Take Out and Drive Thru.....	54
Totaling and Tendering.....	55
Totaling a Cash Sale.....	55
Totaling a Check Sale.....	55
Tendering a Cash Sale	56
Tendering a Check Sale.....	56
Totaling a Charge Sale	57
Tendering a Charge Sale	57
Check Cashing.....	58
Split Tender	58
Post Tender.....	59
Receipt On/Off and Receipt on Request.....	59
Currency Conversion.....	60
Scale Operations	61
Direct Scale Entry	62
Automatic Scale Entry.....	62
Tare Weight Entry	63
Manual Tare Weight Entry.....	63
Manual Weight Entry	64
Check Tracking Operations	65
Overview	65
Posting Balances Manually	67
Soft Check	69

Hard Check.....	72
Fast Food Drive Thru	74
Clerk Interrupt Operation.....	75
To Use Clerk Interrupt System.....	75
Not Found PLU.....	76
Not Found PLU List.....	76

Manager Mode (X Mode) 77

Introduction	77
Overview	77
Manager Mode/Report Mode.....	78
X Reports.....	79
Electronic Journal Operation	80
Declaration.....	81
Training Mode	82
Stock Entry	83
Open Table	85
Save Report.....	85
Receipt On / Off.....	85
IRC Report Polling	86

Z-Mode 87

Overview	87
Accessing Z-Mode Functions	87
Z Reports	88
Reset Electronic Journal	89
Reset Not Found PLU.....	89
Open Table	90

Service Mode Programming 91

Introduction	91
Overview	91
Accessing Service Mode Functions.....	92
Self Test.....	92
Memory Clear.....	94
Clear Totals	94
Clear Grand Total.....	94
Clear PLU File.....	94
Clear Price=0.....	94
Edit Counters	95
Clear Non Mover.....	95
Memory Allocation.....	96
Function Key Assignment	97
Define Port.....	99
Serial Port Setting.....	99
USB Setting.....	100
ECR Setup	101
ROM INFO.....	101
Print Density.....	101
LCD Contrast for 16-Character LCD	101
LCD Contrast for Graphic LCD	101
Set Network.....	101
Program Backup and Restore	103
Program Backup	103

Restore Program	105
Saving Reports	105
Load/Save Receipt Images	107
Saving Images	108
Loading Images	108
Flash ROM Updates	109
Flash ROM Update by SD.....	109
Flash ROM Update by PC.....	110
Help Menu.....	112
IRC Setup	113
REG# (1-8).....	113
IRC SERVER.....	113
IRC CLIENT	114
IRC SELECT.....	114

Program Mode Programming 115

Descriptor Programming Methods.....	116
Descriptor Overlay Method.....	116
Descriptor Code Method	120
Program Mode Menu	122
PLU Programming	123
Add/Change PLU	124
PLU Options - Reference Information	125
Delete PLU	128
PLU STOCK	129
NLU Code# Program.....	130
Group Programming	131
Function Key Programming.....	133
#/NS Function Options	134
%1 -%5 Function Options	135
ADD CHECK Key Program Notes	136
CANCEL Key Program Notes	136
CASH Key Program Notes.....	137
CHARGE 1-8 Keys Program Notes	138
CHECK Key Program Notes	139
CHECK CASHING Key Program Notes	139
CHECK ENDORSEMENT Key Program Notes	140
CHECK # Key Program Notes	141
CURRENCY CONVERSION 1-4	142
EAT-IN, TAKE OUT, DRIVE THRU Key Program Notes	142
ERROR CORRECT Key Program Notes	143
GUEST Key Program Notes.....	143
PRICE LEVEL 1-2 Key Program Notes	144
RETURN Key Program Notes	144
MODIFIER 1-5 Key Program Notes.....	145
PBAL Key Program Notes	145
PAID OUT 1-3 Keys Program Notes	146
PRINT CHECK Key Program Notes	146
PROMO Key Program Notes	147
RECD ON ACCT 1-3 Keys Program Notes.....	147
SCALE Key Program Notes.....	148
SERVICE Key Program Notes.....	148
SUBTOTAL Key Program Notes.....	149
TABLE Key Program Notes.....	149
TARE Key Program Notes	149

TAX EXEMPT Key Program Notes	150
TIP Key Program Notes	150
VOID Key Program Notes	151
WASTE Key Program Notes.....	151
ALPHA TEXT Key Program Notes	151
AUTO CASH 1-8 Keys Program Notes.....	152
PRICE CHANGE Key Program Notes.....	152
VALIDATION Key Program Notes.....	152
Macro Key Programming	153
To Program a Macro.....	153
To Remove a Macro	154
Options Programming.....	155
SYSTEM Options.....	156
PRINT Options.....	160
REPORT Options	161
TAX Options	163
CURRENCY Options.....	164
ROUNDING Options	164
LOGO Options	165
KITCHEN PRINTER Options	165
BARCODE Options	166
EJ Options	166
TRAIN MODE Options	167
TABLE Options	168
DETAIL PRINT Options	168
Employee Programming	169
Clerk Programming - Reference Information.....	169
Time.....	170
Time & Date	170
Time Schedule	170
Taxes Programming.....	172
Programming an Add-On Tax Rate Percentage	172
Programming a VAT Tax (Value Added Tax).....	173
Programming Canadian GST.....	174
Messages.....	177
Postamble	177
Endorsement.....	178
Financial Report	178
Clerk Report	180
Mix & Match Program.....	182
Program Scans	183
Program Down.....	184

Sample Reports

185

Financial	185
Time.....	189
PLU.....	190
Clerk	191
Individual Clerk.....	192
Groups	193
Day	194
Stock.....	194
Check File.....	195
Drawer Totals	195
Balancing Formulas	196

Required ECR Program Settings	197
Define Port (Serial Port Options)	197
System Options.....	198
Function Key Programming	199
Glossary	202
Manual Revision Record	209

Introduction

About the HK-7200 Series

Congratulations! You have selected a very flexible electronic cash register designed for years of reliable service. HK-7200 Series will fit many shops and restaurants, providing fast transaction processing, security, and detailed sales information.

The HK-7200 Series features a unique operator screen that allows you to view itemized transaction information, as well as providing on screen programming that is simple and easy to use. This manual includes in instructions for all models. The keyboard and printer configuration define the model. All other features are same, unless otherwise noted.

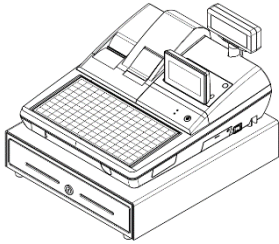
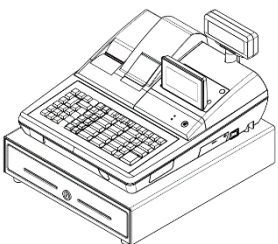
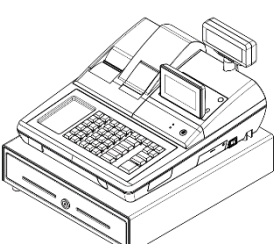
	Flat Keyboard (160 Keys)	Raised Keyboard (90 Keys)	Raised Keyboard (60 Keys)
Two Printer Stations (Receipt and Journal Printers)	 <p>Receipt and Journal Printers Flat Keyboard</p>	 <p>Receipt and Journal Printers Raised Keyboard</p>	 <p>Receipt and Journal Printers Raised Keyboard</p>

Using This Manual

This manual provides you with a means to use your HK-SYSTEMS cash register to its fullest potential. It is divided into seven sections:

1. **“Getting Started”** on page 24 provides quick start steps to help you get up and running for basic applications.
2. **“Operations”** on page 28 guides you through basic operation sequences.
3. **“Manager Mode (X Mode)”** on page 77 explains manager controlled functions, along with X reports and balancing information.
4. **“Z-Mode”** on page 86 explains how to reset register reports as well as other functions performed in the S-Mode: mix & match discounts, PLU lookups and DataTran operations.
5. **“Service Mode Programming”** on page 91 provides instructions for secure programming – usually done by the installing dealer prior to installation.
6. **“Program Mode Programming”** on page 115 provides complete programming instructions, including PLU, function key programs, and options. This section is recommended for use by storeowners and managers. Call your HK-SYSTEMS dealer if you find you need programming assistance.
7. **“Sample Reports”** on page 184 provides a sample of each register report.

The HK-SYSTEMS HK-7200 Series allows many different user applications. This manual was written with this in mind. Although we have tried to touch on all available options, your specific application may differ.

If you have questions concerning the configuration of your HK-7200 Series, please contact your authorized HK-SYSTEMS dealer.

Using Flowcharts

Flowcharts are used to supplement step-by-step instructions throughout this manual. For example, the following flowchart describes how to register \$1.00 into the PLU1 key:



This flowchart means:

- Press numeric key 1.
- Press numeric key 0.
- Press numeric key 0.
- Press PLU #1.

Follow the flowchart from left to right, pressing the keys in the order they are shown. Numeric keypad entries are shown as square keys. PLU and function keys are shown as rectangular keys.

Identifying Components & Connections

Identifying Components

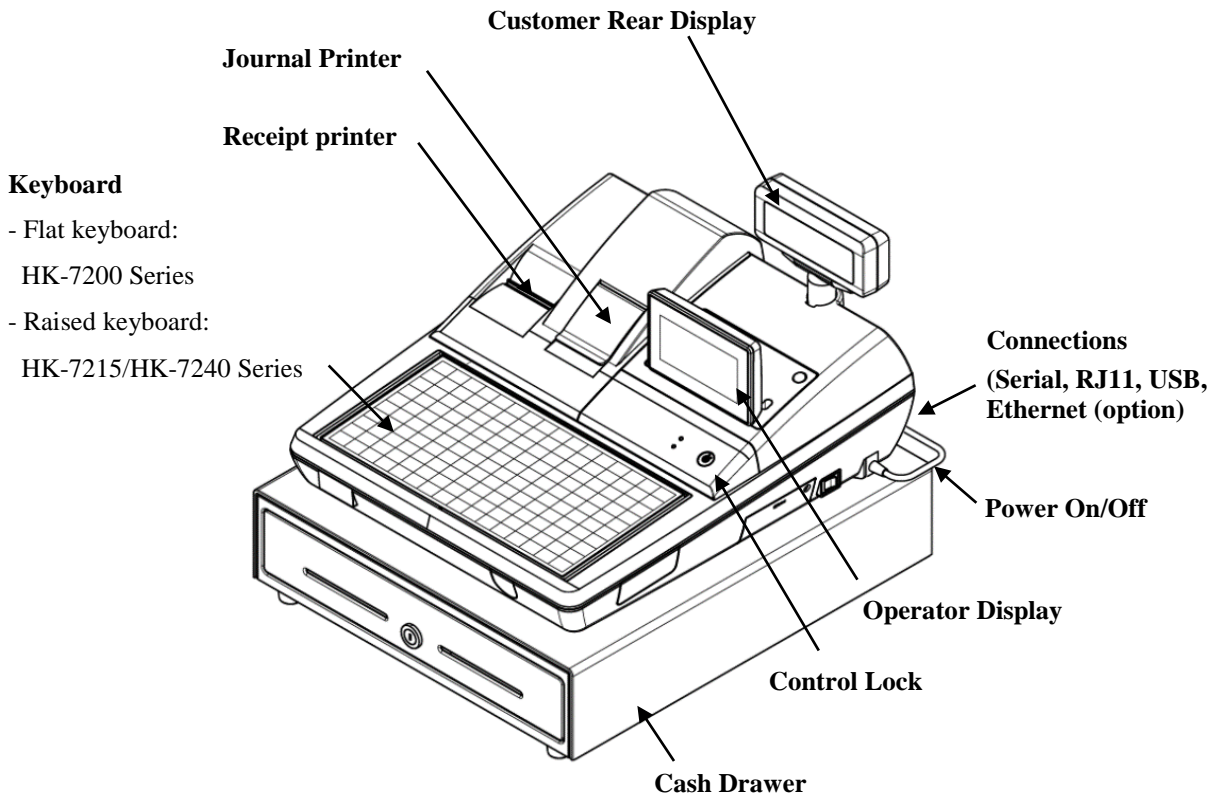

Inserting External SD Card

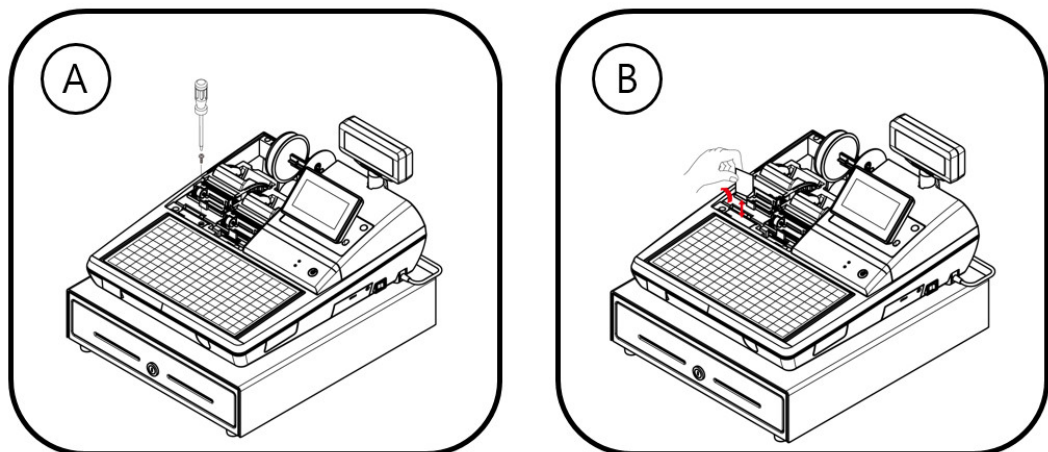

- The SD slot is located in the printer compartment. Remove the printer cover.
- Remove the security screw to access the slot.
- Insert or Remove the SD card.

Connections

- The Serial port can be connected to PC, Scanner, Kitchen Printer Scale and Pole display.
- The USB (Device and Host) port can be connected to PC, scanner or memory device.
- If you want to know more details, See page 100 for USB specification.
- The Ethernet port(LAN) is option.

Programmable Features

- Memory Allocation System Supports:
 - ⇒ Over 10,000 Price Look Ups (PLU's) are available
 - ⇒ Up to 99 clerks with separate report totals
 - ⇒ Up to 99 PLU Group totals
 - ⇒ Up to 2 Price levels for each PLU
 - ⇒ Electronic Journal
 - ⇒ Hard or Soft Guest Checks
- Up to 5 PLU modifier keys (i.e. small, medium, and large)
- 18-character programmable descriptors for PLU's and functions
- Four tax rates with value added tax (VAT) and ADD-ON capability.
- Programmable functionality for each key location
- 24-hour real-time clock with automatic day and date change
- Check, Cash, and up to 8 charge tender functions
- Currency conversion capability for up to 4 foreign currencies
- Training mode
- Programmable discount/surcharge/coupon keys
- Error Correct, Void, and Cancel Transaction functions
- Function keys for posting charges and payments to accounts or guest checks
- Macro, Price Inquiry, Promo and Waste functions
- Management X and Z reports
- Electronic Journal capability
- 6-line programmable preamble and postamble messages
- Programmable descriptors for financial and clerk reports
- Up to 100 Mix & Match discounts

Display

The operator display of HK-7200 Series comes with a 192 x 64 Graphic blue backlit LCD or 2 Line 16-character blue backlit LCD.

As items are registers, the item description will display on the first line; price and quantity information will display on the second line. Additional information and error messages will display as appropriate, and may be accompanied by an error tone.

Note: This manual has been described on basis of Graphic LCD model.

Graphic Blue Backlit LCD

REGISTER MODE

Note: The “CLOSED” message will display if a clerk is not signed on.

```
R:ON CLERK 00      K1 P1
                    REGISTER MODE
                                   CLOSED
```

```
R:ON CLERK 01      K1 P1
                    REGISTER MODE
```

VOID MODE

Note: The “CLOSED” message will display if a clerk is not signed on.

```
R:ON CLERK 00      K1 P1
                    VOID MODE
                                   CLOSED
```

```
R:ON CLERK 01      K1 P1
                    VOID MODE
```

MANAGER MODE (X)

```
R:ON CLERK 00      K1 P1  
  
MANAGER MODE  
CLOSED
```

- Press the **CASH** to display X MODE menu.

```
          X MODE  
1.X REPORTS      ←  
2.DECLARATION  
3.FLASH REPORT  
4.SET TRAIN MODE  
5.STOCK ENTRY  
6.SAVE RPT SD  
          -PAGE 1/2-
```

```
          X MODE  
7.RCPT ON/OFF   ←  
  
          -PAGE 2/2-
```

- Press the ↑ key and the ↓ key to select menu and press the **CASH** key to confirm.
- You can also select menu by **page**↑ key and **page**↓ key.

Z-MODE

```
          Z MODE  
1.Z REPORTS      ←  
2.RESET E.J  
3.RESET NOT FOUND PLU LIST  
4.CONNECT SERVER  
5.DATATRAN FUNCTION  
6.DATATRAN TRANSACTION  
          -PAGE 1/1-
```

- Press the ↑ key and the ↓ key to select menu and press the **CASH** key to confirm.
- You can also select menu by **page**↑ key and **page**↓ key.

PROGRAM MODE (P)

```
PROGRAM MODE
1. PLU
2. GROUP
3. FUNCTION KEY
4. OPTIONS
5. EMPLOYEE
6. TIME
-PAGE 1/2-
```

```
PROGRAM MODE
7. TAXES
8. MESSAGES
9. MIX & MATCH
10. PGM SCAN
11. PROGRAM DOWN
-PAGE 2/2-
```

- Press the ↑ key and ↓ key to select menu and press the CASH key to confirm.
- You can also select menu by page ↑ key and page ↓ key.

SERVICE MODE (S)

```
SERVICE MODE
1. SELF TEST
2. MEMORY CLEAR
3. ALLOCATION
4. KEY ASSIGN
5. DEFINE PORT
6. ECR SETUP
-PAGE 1/2-
```

```
SERVICE MODE
7. PROGRAM BACKUP
8. HELP MENU
9. IRC SETUP
-PAGE 2/2-
```

- Press the ↑ key and the ↓ key to select menu and press the CASH key to confirm.
- You can also select menu by **page** ↑ key and **page** ↓ key.

Printer/Printers

For information about loading paper into the printer, refer to the section “Installing the paper” which can be found on page “25”.

HK-7200 Series (2 Station)

HK-7200 Models feature separate receipt and journal printers.

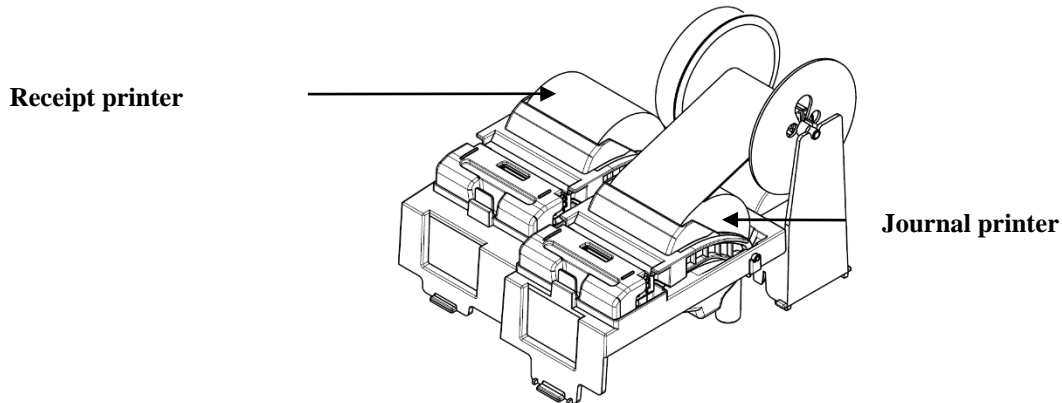

Printer Specifications

Paper		58mm Thermal Paper
Paper Loading:		Drop-in Loading
Paper Diameter:		70 Ø_max
Print Speed:	Normal	50mm/s
	Max	70mm/s
Paper end sensor		YES

Control Lock

The control lock has 7 positions, accessed with 5 keys. Each ECR is shipped with two full sets of keys.

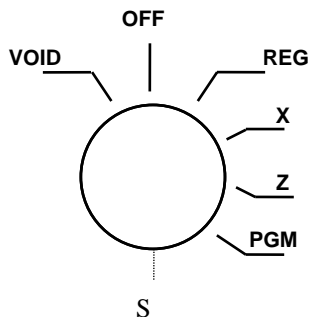

VOID	Use to void (correct) items outside of a sale.
OFF	The register is inoperable.
REG	Use for normal registrations.
X	Use to read register reports.
Z	Use to read register reports and reset totals to zero.
PGM	Use to program the register.
S	The S position is a hidden position reserved for dealer access.

Before performing any operations in Register Mode, a clerk must be signed on. See “Clerk Sign-On/Sign-Off” for a description of clerk operations.

Control Keys

All HK-7200 Series models include two sets of keys that may be used to access the following control lock positions.

<u>Key</u>	<u>Positions Accessible</u>
REG	OFF, REG
VD	VOID, OFF, REG, X
Z	VOID, OFF, REG, X, Z
P	VOID, OFF, REG, X, Z, PGM
C	ALL POSITIONS

Note: Keys may be removed from the control lock in the OFF or REG positions.

Keyboards

HK-7200 Flat Keyboard Versions

The HK-7200 keyboard is shown below with the default legends and key assignments. This configuration has 110 keyboard NLU locations.

Programmable key locations are shown with a bold border.

1	11	21	31	41	51	61	71	81	91	101	FEED	JOURNAL FEED	RCPT ON/OFF	VOID	CLERK
2	12	22	32	42	52	62	72	82	92	102	% 1	RECD ACCT	PAID OUT	# / NS	RETURN
<	>	?	=								% 2	TAKE OUT	EAT IN	TAX 2	TAX 1
!	@	#	\$	%	^	&	*	()	~	% 3	CHECK #	SERVICE	TABLE #	PRINT CHECK
Q	W	E	R	T	Y	U		O	P	*	↑ YES	PAGE UP	ERROR CORR	PAGE DOWN	CANCEL
A	S	D	F	G	H	J	K	L	;	'	↓ NO	CLEAR	PLU	X/TIME	ADD CHECK
Z	X	C	V	B	N	M	,	.	/	:	MACRO1	7	8	9	CHARGE 1
CAPS	DOUBLE	SPACE	SPACE	SPACE	SPACE	SPACE	SPACE	DOUBLE	BACK SPACE	*	MACRO2	4	5	6	CHECK
9	19	29	39	49	59	69	79	89	99	109	MACRO3	1	2	3	SBTL
10	20	30	40	50	60	70	80	90	100	110	MACRO4	0	00	.	CASH

HK-7240 Raised Keyboard Versions

The HK-7240 is shown below with the default legends and key assignments. This configuration has 15 keyboard NLU locations.

Programmable key locations are shown with a bold border.

FEED	JOURNAL FEED	RCPT ON/OFF	#/NS	TAX1	TAX2	RECD ACCT SEP	PAID OUT MACKSPACE	MACRO1 SPACE	MACRO2 DOUBLE	MACRO3 CAPS	MACRO4	F/S SHIFT	F/S SUB (PAGE↑)	CLERK (PAGE↓)	
ERROR CORR	PLU	CLEAR		X/TIME		1	6	11		F/S TEND (↑)	CHECK (↓)		F/S TEND (↑)	CHECK (↓)	
VOID		7	8	9		2	7	12							CHARGE
CANCEL		RETURN	4	5		6	3	8							13
%1	%3	1	2	3		4	9	14							CASH
%2	%4	0	00	.		5	10	15							
						**0*	! , &	. (-)							

HK-7215 Raised Keyboard Versions

The HK-7215 keyboard is shown below with the default legends and key assignments. This configuration has 5 keyboard NLU locations.

Programmable key locations are shown with a bold border.

RECEIPT FEED	DETAIL FEED	RECEIPT ON/OFF	TAX1 SHIFT CAP	TAX2 SHIFT DOUBLE	MACRO1 SPACE	MACRO2 BACKSPACE	F/S SHIFT AB	F/S SUB (PAGE↑) CD	CLERK (PAGE↓) EF
VOID \$■	#/NS #e	CLEAR	PLU	X/TIME	1	GHI		F/S TEND (↑) JK	CHECK (↓) LM
RETURN .(ERROR CORR -)	7	8	9	2	NOP		CHARGE QR	
%1 %-	CANCEL *?)	4	5	6	3	STU		SBTL	
%2 I*	P/O +@:	1	2	3	4	VWX		CASH	
%3 SKP	R/A ,&*	0	00	.	5	YZ			

Initial Clear

CAUTION: Do not share this information with unauthorized users. This procedure will not affect register programming, or clear previously stored totals in RAM memory.

The initial clear function allows you to exit any register activity and return to a beginning or cleared state. Any transaction that is in progress will be exited and totals for that transaction will not be updated.

Here are some reasons you may want to perform an initial clear:

- The register is in an unknown state, and you wish to exit the current program or transaction without following normal procedures.
- You have performed a function that includes a compulsory activity and you wish to bypass the compulsion.
- An initial clear may be necessary as part of servicing or troubleshooting.

Perform this procedure only as necessary. Contact your HK-SYSTEMS dealer first if you have questions about operating or programming your HK-SYSTEMS HK-7200 Series.

To Perform an Initial Clear:

1. Move to the **PROGRAM MODE**.
2. Turn the power switch located on the right side of the register to the **OFF** position.
3. Press and hold the key position where the **SUBTOTAL** key is located on the default keyboard layout.
4. While continuing to hold the **SUBTOTAL** key, turn the power switch to the **ON** position. When the "INITIAL CLEAR" message displays release the **SUBTOTAL** key.

INITIAL CLEAR
ENTER CASH KEY

5. Press the **CASH** key.

ARE YOU SURE?
Y=CASH N=CLEAR

6. Press the **CASH** key. The message "INITIAL CLEAR OK!" prints when the initial clear is complete. To resume operations, you will need to sign on a clerk.

Getting Started

Quick Start Steps

HK-SYSTEMS ECRs are designed to work out-of-the-box. You can sign on a clerk, enter amounts and finalize a sale. Most functions are active and ready to use.

Use the Quick Start Instructions provided here to prepare your HK-7200 Series ECR for entering a program. Because the HK-7200 Series features on-screen programming, the dealer or user can simply follow the menus presented when the mode is moved to the **PROGRAM MODE**. Detailed programming steps and reference information is found in the Program section of this manual.

Steps In this chapter:

1. Unpacking
2. Installing the Paper
3. Clearing All Memory

Unpacking

1. Unpack and unwrap the cash register.
2. Locate in the packing the following items:
 - a. Paper roll(s)
3. Plug the register into a grounded outlet, turn the power switch on.

Installing the Paper

1. Remove the printer cover.
2. Lift up to open the paper cover.
3. Ensure that the paper is being fed from the bottom of the roll and then close the paper cover slowly until it locks firmly.
4. Pass the leading edge of the paper through the tear-bar slot. Tear off the excess paper. Replace the printer cover.

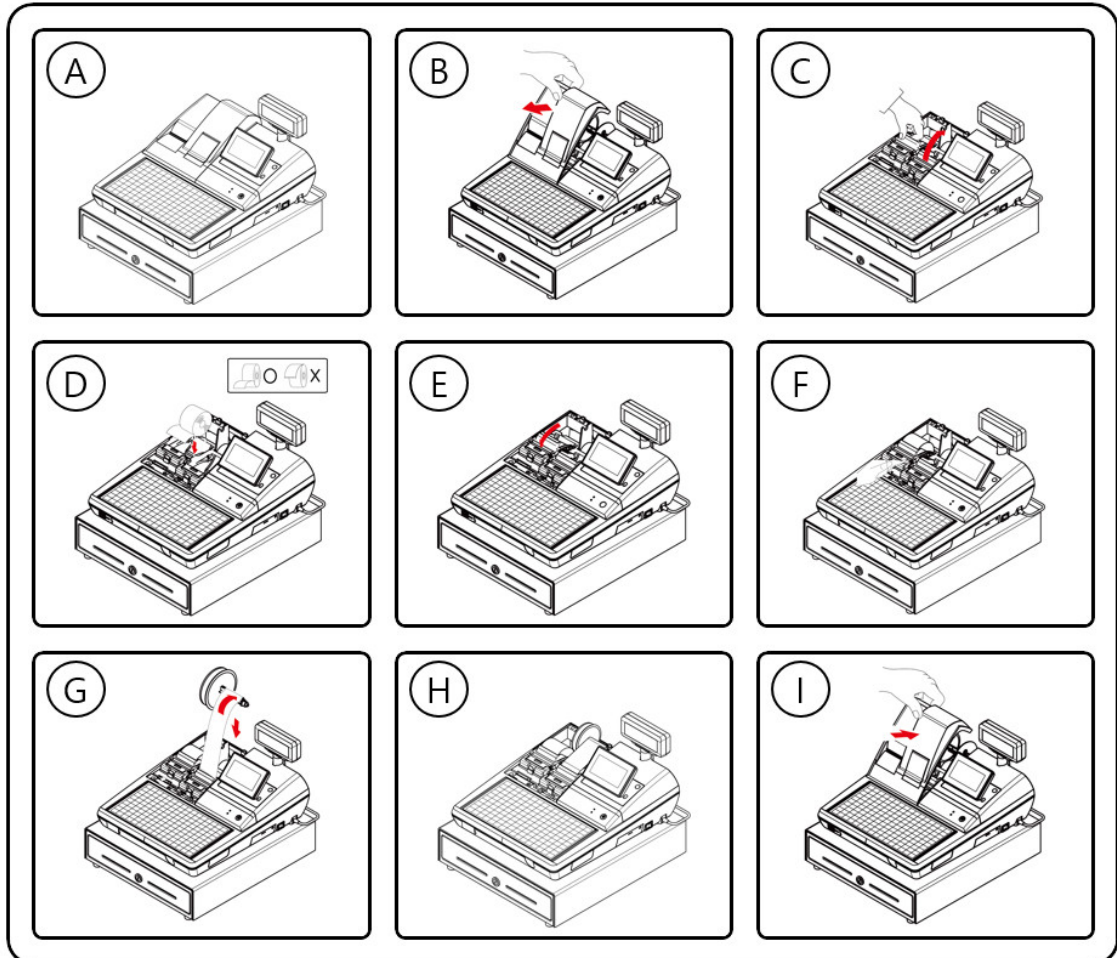

Clearing Memory

Before you use your HK-7200 Series ECR for the first time, you **must** perform a memory all clear to ensure that all totals and counters are cleared and that the default program is installed.

CAUTION: The procedures described in this area are security sensitive. Clearing the HK-7200 Series memory after the register is put into service will erase all programming as well as totals and counters. Do not share this information with unauthorized users and distribute the “SERVICE MODE” access key only to those you may want to perform these functions.

1. Move to the **SERVICE MODE**.
2. Turn the power switch located on the right side of the register to the **OFF** position.
3. Press and hold the key position where the **CHECK** key(HK-7200) ,
SBTL key(HK-7240/7215) is located on the default keyboard layout.
4. Continue to hold the appropriate key while turning the power switch to the **ON** position. The message “**RAM ALL CLEAR**” displays.
5. Press the **Upper Left** key of the keyboard, then the **Lower Left** key, then the **Upper Right** key, and finally press the **Lower Right** key.

<HK 7200 Flat Keyboard>

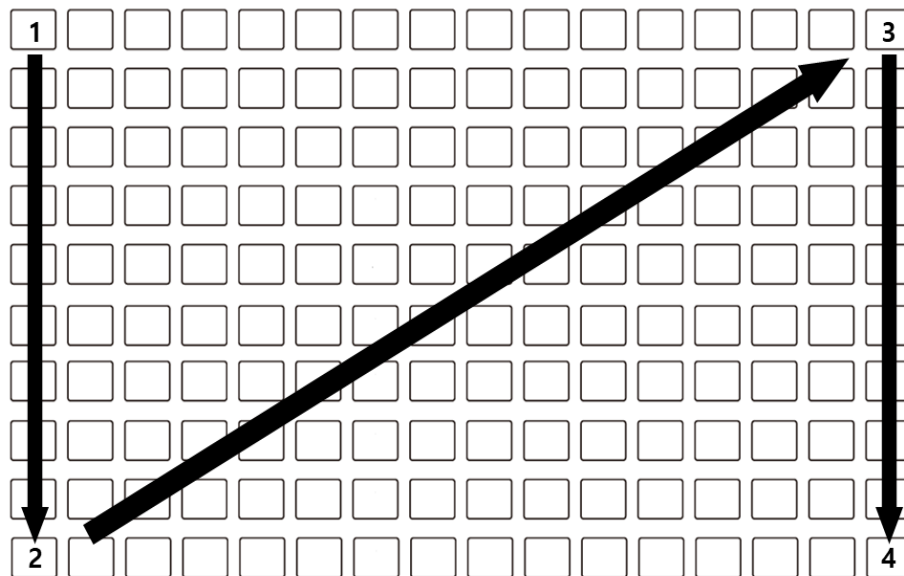

<HK 7240 Raised Keyboard>

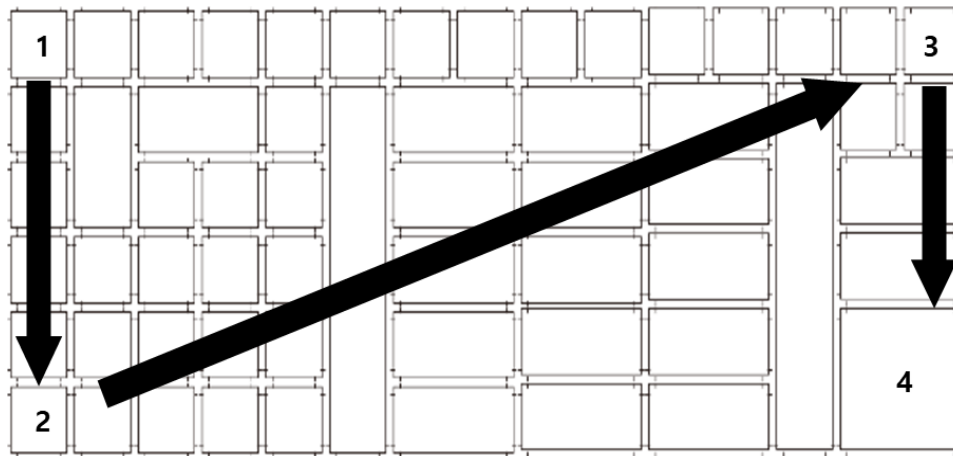

<HK 7215 Raised Keyboard>

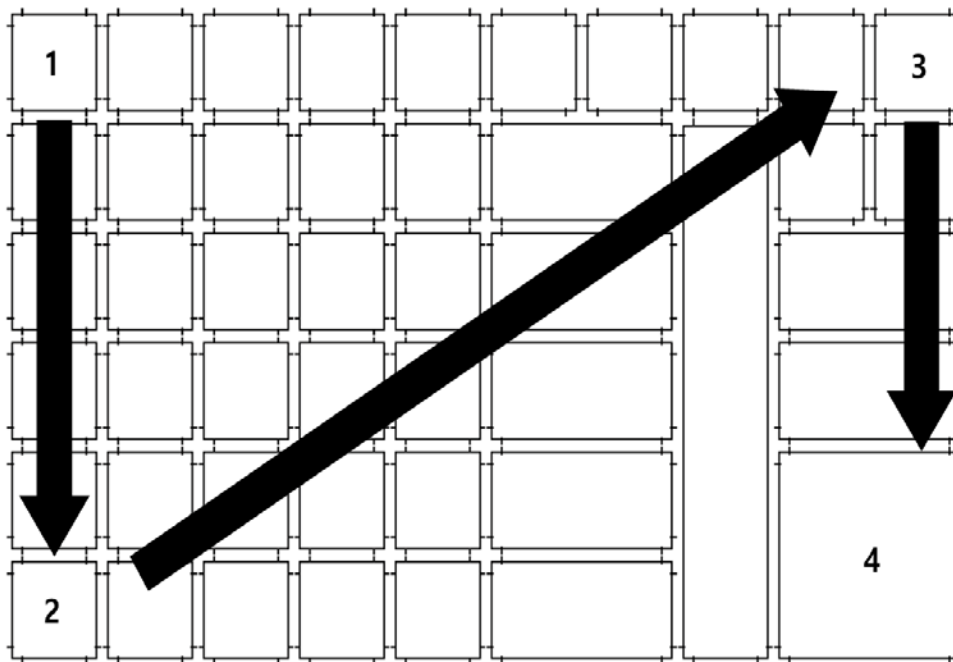

6. The SERVICE MODE menu displays. The RAM Clear procedure is complete and the receipt prints.

Operations

Introduction

HK-7200 is designed for easy sale operation. You just need to select numbers and PLU's for sales operation without any unnecessary work. You can also operate easier by using Program Mode.

Overview

The following procedures are done from the Register Mode menu:

- ◆ Clerk Operations
- ◆ Item Registrations
- ◆ Shifting or Exempting Tax
- ◆ Percent Key Operations
- ◆ Return Merchandise Registrations
- ◆ Voids and Corrections
- ◆ No Sale Operations
- ◆ Received On Account Operations
- ◆ Paid Out Operations
- ◆ Subtotaling a Sale
- ◆ Eat in / Take Out / Drive Thru Sales
- ◆ Totaling and Tendering
- ◆ Check Tracking Operations
- ◆ Not Found PLU

Function key Descriptions

Keys are listed in alphabetical order. Many of the keys described below are not included on the default keyboard. See “Function Key Assignment” on page 97 to add or change programmable keys.

Function key	Description
#/NS	Use as a non-add key to print a numeric entry (up to 8-digits) on the receipt and journal. This entry will not add to any sales totals. The #/NS key is also used to open the cash drawer without making a sale.
X/TIME	Use to multiply a quantity of items or calculate split pricing on PLU entries.
00, 0-9, DECIMAL	Use to make numeric entries in REG, X, Z, VOID, or P positions. The decimal key is used for decimal or scale multiplication, when setting or entering fractional percentage discounts, or when programming fractional tax rates. <i>Do not use the decimal key</i> when making amount entries into PLU's.
ADD CHECK	Use to combine individual trays (such as in a cafeteria situation). Each tray subtotal can advance the consecutive number, depending on programming.
CANCEL	Cancels a transaction without updating PLU, or function key totals. The Cancel function may only be used prior to tendering. Once tendering begins, the Cancel function may no longer be used. The CANCEL key corrects the appropriate totals and counters and the Financial report records total of transactions canceled.
CASH	Use to finalize cash sales. Calculates the sale total including tax and opens the cash drawer. Change computation is allowed by entering an amount before pressing the CASH key. The cash drawer will open only if the amount tendered is equal to or greater than the total amount of the sale. Post tendering is also available should a second change calculation be necessary. Re-enter the tendered amount and press the CASH key to show the new change computation. Press the CASH key a second time to issue a buffered receipt when the receipt on/off function is OFF.
CHECK CASHING	Use to exchange a check for cash. Cash-in-drawer and check-in-drawer totals are adjusted.
CHECK ENDORSEMENT	Use to print a check endorsement message on an optional slip printer. A programmable message up to 10 lines can also be printed.
CHECK	Use to finalize check sales. Calculates the sale total including tax, finalizes the sale, and opens the cash drawer. Change computation is allowed by entering an amount before pressing the CHECK key. The cash drawer will open only if the amount tendered is equal to or greater than the total amount of the sale. Change issued will be subtracted from the cash-in-drawer total.
CHECK#	The CHECK # key is used to begin a new or access an existing balance (hard check) or itemized bill (soft check.) Check track numbers that are entered manually may be set at a fixed length of one to nine digits. Check track numbers assigned automatically will begin with #1. Existing checks are accessed by entering the check track number and pressing the CHECK # key.
CHARGE (1-8)	Use to finalize charge sales. Calculates the sale total including tax, finalizes the sale, and opens the cash drawer. Change computation is allowed by entering an amount before pressing the CHARGE key. The cash drawer will open only if the amount tendered is equal to or greater than the total amount of the sale. Change issued will be subtracted from the cash-in-drawer total.
CLEAR	Use to clear entries made into the 10-key numeric pad or X/TIME key before they are printed. Also used to clear error conditions.

Function key	Description
CLERK	<p>The register will not operate in register mode unless a clerk has been signed on. Direct or secret code sign on procedures accomplishes clerk sign-on.</p> <p>All entries made on the register will report to one of the 10 clerk totals. When a clerk is signed on, all entries following will add to that clerk's total until another clerk is signed on.</p> <p>To sign a clerk off, enter 0 (zero) and then press the CLERK key. The "CLOSED" message displays. The register cannot be operated until another clerk is signed on. The current clerk must first be signed off before another clerk may be signed on.</p>
CONV (1-4)	<p>The currency conversion function, allowed after subtotal, converts and displays the new subtotal at a preprogrammed exchange rate. Tendering is allowed after using the currency conversion function. Change is calculated and issued in home currency. The amount of foreign currency tendered is stored in a separate total on the Financial report, but not added to the drawer total.</p>
EAT-IN TAKE OUT DRIVE THRU	<p>Eat-In, Take Out and Drive Thru are subtotal functions. In areas that have different tax rules for eat-in and take out sales, the EAT-IN, TAKE OUT and DRIVE THRU keys can be programmed to automatically charge or exempt taxes.</p> <p>Sales may not be split between Eat-In, Take Out and Drive Thru.</p> <p>The EAT-IN, TAKE OUT and DRIVE THRU keys maintain separate totals on the Financial report.</p>
ERROR CORR	<p>Use to correct the last entry. The ERROR CORR key corrects the appropriate totals and counters.</p>
GUEST	<p>Use to enter the count of guests served as part of a guest check. The entry of a guest count can be enforced when opening a guest check, or for all transactions.</p>
LEVEL (1-2)	<p>Price Level keys shift the price PLU that is being registered. Levels can be stay down; pop-up after each item to register, for example large, medium or small soft drink; pop-up after each transaction to register, for example, toppings of various pizza sizes.</p>
MACRO (1-10)	<p>Macro keys may be programmed to record, and then later perform, up to 50 keystrokes. For example, a macro key could be set to tender (preset tender) a common currency, such as \$5 into the cash key.</p>
RETURN	<p>Used to return or refund merchandise. Returning an item will also return any tax that may have been applied.</p>
RECEIPT ON/OFF	<p>When 'OFF' no receipt will print during a sale. (If the receipt is off, a buffered receipt is available by pressing the CASH key a second time.)</p>
MODIFIER (1-5)	<p>A modifier key alters the next PLU registered, either by changing the code number of the PLU so that a different item is registered, or by adding the modifier descriptor (and not changing the code of the subsequent PLU.)</p>
PAID OUT (1-3)	<p>Use to record money taken from the register to pay invoices, etc. The paid out amount subtracts from the cash-in-drawer total. Paid outs are allowed outside of a sale only.</p>
PBAL	<p>Use to enter the amount of an outstanding balance. The PBAL key will take the recall function if the drive thru feature is enabled in CHECK # key programming.</p>
%1 - %5	<p>Up to five % keys may be placed on the keyboard. Each % key is set with a specific function, such as item discount or surcharge, or sale discount or surcharge. The percent rate may be entered or preprogrammed, or the percent keys can be programmed with a negative open or preset price, thus acting as coupon keys.</p>
PLU	<p>The PLU key is used to register price lookups by number entry. PLU's can be programmed open or preset, and positive or negative.</p>

Function key	Description
PRINT CHECK	Use to print a guest check. The check can be printed on an optional (RS-232C) printer or can be printed on the receipt printer. The PRINT CHECK key can be set to automatically service the check.
PRICE CHANGE	Use to change the price of a PLU in register mode.
PRICE INQUIRY	Use to display the price of a PLU without registering the price.
PROMO	The PROMO key allows you to account for promotional items, as in "buy two, get one free". Pressing this key will remove an item's cost from the sale but will include the sale of the item in the item's sales counter.
FEED	Advances the receipt paper one line, or continuously until the key is released.
RECD ACCT (1-3)	The RA (received on account) key is used to record media loaned to the cash drawer, or payments received outside of a sale. The cash drawer will open. The amount received adds to the cash-in-drawer total.
SCALE	Use to make weight entries. When a scale is attached, press the scale key to show the weight in the display, then press (or enter) a PLU to multiply the weight times the price. When a scale is not attached, you can manually enter the weight (using the decimal key for fractions). PLU's may be programmed to require an entry through the scale key.
SERVICE	Use to temporarily finalize Previous Balance or check tracking transactions.
SUBTOTAL	Displays subtotal of sale including tax. Must be pressed prior to a sale discount or sale surcharge.
TABLE	You can enforce the entry of a table number for guest check transactions, or for all transactions. If you are tracking guest check balances, the balance can be recalled either by entering the check number or the table number.
TARE	Tares are container weights. If you are using the scale function, you can preset up to 5 different tare weights. The tare is subtracted automatically when a specific PLU is registered, or the tare can be subtracted by manually inputting the tare number and pressing the TARE key. Tare #5 can be programmed for entering tare weights manually.
TAX EXEMPT	Press the TAX EXEMPT key to exempt tax 1, tax 2, tax 3, and/or tax 4 from the entire sale.
TAX SHIFT (1-4)	When pressed before a PLU entry, the tax shift keys reverse the tax status of the PLU, i.e., a PLU with non-tax status would become taxable or a PLU with tax status would become non-taxable.
TIP	The TIP key allows a gratuity to be added to a guest check before payment. The tip amount is deducted from the Cash-in-Drawer amount for the Clerk/Cashier closing the guest check. The TIP key may be programmed as either a percentage or amount. If programmed as a percentage, tax programming defines whether the percentage is calculated on the net amount, or the amount after taxes.
VOID	Use to correct an item entered earlier within a sale. The VOID key corrects the appropriate totals and counters. To correct the last item, use the ERROR CORR key. For void operations outside of a sale (Transaction Void), use the VOID MODE . The Financial report records totals for each type of void separately.

Function key	Description
WASTE	Allows control of inventory by accounting for items that must be removed from stock due to spoilage, breakage or mistakes. Press the WASTE key before entering wasted items, and then press the WASTE key again to finalize. The WASTE key may be under manager control, requiring the mode to be in the MANAGER MODE . The WASTE key is not allowed within a sale.
VALIDATION	Press to initiate a single line validation. Note that an optional printer with validation capability must be attached to the HK-7200 and identified.

Clerk Operations

The number of clerks available is determined by memory allocation. (The default configuration provides 10 clerks.) See “ALLOCATION” in the “*Service Mode Programming*” chapter to set the number of clerks as well as other memory variables.

You can choose a Direct sign-on or code entry clerk system:

- You can provide maximum security in a multiple clerk system with the code entry system. Enter the clerk secret code, and then press the **CLERK** key to sign on the register.
- You can sign off a clerk by entering **0**, then pressing the **CLERK** key.

You can also select stay down or pop-up mode for clerk operation:

- Stay down means that once a clerk is signed on, the same clerk will remain signed on until the clerk signs off. A stay down clerk system might be used when only one operator uses the register at a time and a different operator begins when a work shift is changed.
- Pop-up means that the clerk is automatically signed off at the end of each transaction. To begin a transaction, you must first sign a clerk on. A pop-up clerk system might be used in a department store, where several clerks use the register during the same shift and clerk sales information is required.

See “SYSTEM Options” of “Options Programming” in the “Program Mode Programming” chapter to set clerk options.

Clerk Sign On Instructions

When a clerk is not signed on, the message "CLOSED" is shown on the display. Note that the current clerk must be signed off before a new clerk can be signed on.

Direct Sign-on

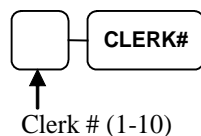

Code Entry

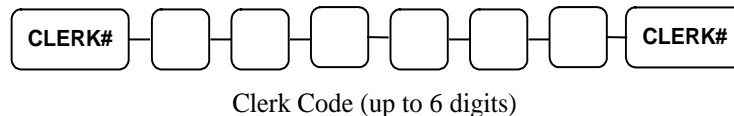

Clerk Sign Off Instructions

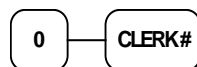

Item Registrations

All registrations are accumulated into PLU's. Keyboard PLU's are fixed keys on the keyboard (like traditional department keys) that access specific PLU's.

- Traditional code-entry PLU's can also be registered by entering the PLU number and pressing the PLU key.
- If optional scanning is implemented, the PLU number corresponds to the UPC number and a PLU is registered when an item is scanned.

As you make item registrations, you can follow your entries by viewing the display. Remember that the sale and tax totals are updated automatically with each entry.

Keyboard PLU Entries

As you make PLU registrations, you can follow your entries by viewing the display.

In the following examples:

- PLU1 is programmed with a preset price of \$1.99 and is taxable by Tax 1.
- PLU2 is programmed for open entries.
- PLU3 is programmed with a preset price of \$2.99 and is taxable by Tax 1.
- PLU5 is programmed with a preset price of \$1.29 and is taxable by Tax 1.
- PLU6 is programmed with a single item of \$6.00.
- Tax 1 is programmed at 6%.

Open Keyboard PLU Entry

1. Enter an amount on the ten-key pad. *Do not use the decimal key.* For example, for \$2.99, enter:

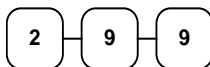

2. Press a PLU key. Example: press **PLU 1**:

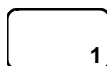

THANK-YOU CALL AGAIN		
05/01/2019 WED		08:33
PLU1 T1		\$2.99
TAX1		\$0.18
TOTAL		\$3.17
CASH		\$3.17
CLERK 01	000011	00001

Preset Price Keyboard PLU

A preset PLU registers the price that was previously programmed for the PLU. See “PLU Programming” in the "*Program Mode Programming*" chapter to program preset prices.

1. Press a preset PLU key. For example, press **PLU 5**:

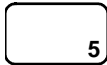

THANK-YOU		
CALL AGAIN		
05/01/2019 WED		08:33
PLU5		\$1.29
TOTAL		\$1.29
CASH		\$1.29
CLERK 01	000011	00001

Gallonge PLU Entry

1. Enter the total fuel purchase on the ten-key pad. *Do not use the decimal key.* For example, for \$20.00, enter:



2. Press a PLU key set to gallonage function. For example, press **PLU 7**:

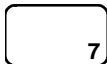

THANK-YOU		
CALL AGAIN		
05/01/2019 WED		08:33
GAL CNT		#5.26
GAL AMT	@	3.799
PLU7		\$20.00
TOTAL		\$20.00
CASH		\$20.00
CLERK 01	000011	00001

Keyboard PLU Repeat Entry

Open or preset price PLU's can be repeated as many times as necessary by pressing the same PLU again. The number of times the item is repeated is shown on the display.

1. Enter an amount on the ten-key pad. *Do not use the decimal key.* For example, for \$2.99, enter:

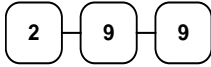

2. Press a PLU key. Example: press **PLU 1**:



3. To register a second item exactly as the first, press the PLU key a second time. For example, press **PLU 1**:



THANK-YOU CALL AGAIN		
05/01/2019 WED		08:33
PLU1 T1		\$2.99
PLU1 T1		\$2.99
TAX1		\$0.36
TOTAL		\$6.34
CASH		\$6.34
SUNNY	000011	00001

Keyboard PLU Multiplication

When several of the same items are to be entered into the same PLU, you can use multiplication. You can enter a quantity (1 to 999.999) using the **X/TIME** key. You can multiply open or preset PLU's.

1. Enter the quantity of items being purchased; press the **X/TIME** key. For example, enter **4** on the numeric key pad and press the **X/TIME** key:



2. Enter an amount on the ten-key pad. *Do not use the decimal key.* For example, for \$1.99, enter:

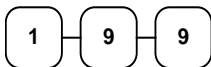

3. Press a PLU key. For example: press **PLU 1**:

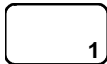

THANK-YOU CALL AGAIN		
05/01/2019 WED		08:33
4X	@1.99	
PLU1 T1		\$7.96
TAX1		\$0.48
TOTAL		\$8.44
CASH		\$8.44
SUNNY	000011	00001

Keyboard PLU Multiplication with Decimal Point

If you are selling items by weight, or if you are selling yard goods, you can use the X/Time key to multiply a fraction of a unit.

1. Enter the amount with the decimal point; press the **X/TIME** key. For example, for \$3.75 of produce, enter:

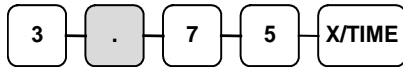

2. Enter an amount on the ten-key pad. *Do not use the decimal key.* For example, if the price is \$0.99 per pound, enter:



3. Press a PLU key. For Example: press **PLU 1**:

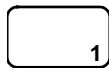

THANK-YOU CALL AGAIN		
05/01/2019 WED		08:33
3.75X	@0.99	
PLU1 T1		\$3.71
TAX1		\$0.22
TOTAL		\$3.93
CASH		\$3.93
CLERK 01	000011	00001

Split Pricing (Keyboard PLU)

When items are priced in groups, i.e. 3 for \$1.00, you can enter the quantity purchased and let the register calculate the correct price.

1. Enter the quantity purchased; press the **X/TIME** key. For example, enter:



2. Enter the quantity of the group price; press the **X/TIME** key. For example, if the items are priced 3 for \$1.00, enter:

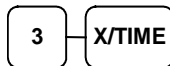

3. Enter an amount on the ten-key pad. For example, if the items are priced 3 for \$1.00, enter:

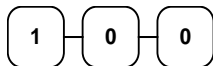

4. Press a PLU key. For example: press **PLU 1**:

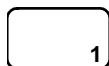

THANK-YOU CALL AGAIN		
05/01/2019 WED		08:33
2@3FOR	@1.00	
PLU1 T1		\$0.67
TAX1		\$0.04
TOTAL		\$0.71
CASH		\$0.71
CLERK 01	000011	00001

Single Item Keyboard PLU

Single item PLU's automatically total as a cash sale immediately after registration. Use single item PLU's for speedy one item sales. For example, if you are selling admission tickets, and all ticket sales are one item sales, you can use an open or preset PLU. After each registration, the drawer will immediately open, and a separate transaction receipt is printed. See "PLU Programming" in the "Program Mode Programming" chapter to program a single item PLU.

1. Press a single item preset PLU key (or enter a price and press a single item open PLU key.) For example, press **PLU 6**:

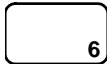

THANK-YOU CALL AGAIN		
05/01/2019 WED		08:33
PLU6		\$1.29
TOTAL		\$1.29
CASH		\$1.29
CLERK 01	000011	00001

Open Code Entry PLU

If the PRESET status of a PLU is set to N (no), the PLU will operate as an open PLU.

See "PLU Programming" in the "Program Mode Programming" chapter to program PLU descriptors and options.

1. Enter the PLU number; press the PLU key.
For example, enter:



2. The display will prompt "ENTER PRICE". Enter an amount on the ten-key pad. *Do not use the decimal key.* For example, for \$2.99, enter:

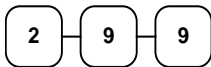

3. Press the **PLU** key again.



THANK-YOU CALL AGAIN		
05/01/2019 WED		08:33
PLU2 T1		\$2.99
TAX1		\$0.18
TOTAL		\$3.17
CASH		\$3.17
CLERK 01	000011	00001

Preset Price Code Entry PLU

1. Enter the PLU number; press the PLU key.
For example, enter:



THANK-YOU CALL AGAIN		
05/01/2019 WED		08:33
PLU1		\$1.29
TOTAL		\$1.29
CASH		\$1.29
CLERK 01	000011	00001

Code Entry PLU Multiplication

When several of the same items are to be entered into the same PLU, you can use multiplication. You can enter a quantity (1 to 999.999) using the **X/TIME** key. You can multiply open or preset PLU's.

1. Enter the quantity of items being purchased; press the **X/TIME** key. For example, enter **4** on the numeric key pad and press the **X/TIME** key:



2. Enter the PLU number; press the **PLU** key.
For example, enter:



THANK-YOU CALL AGAIN		
05/01/2019 WED		08:33
4X	@1.99	
PLU1 T1		\$7.96
TAX1		\$0.48
TOTAL		\$8.44
CASH		\$8.44
CLERK 01	000011	00001

Code Entry PLU Multiplication with Decimal Point

If you are selling items by weight, or if you are selling yard goods, you can use the X/Time key to multiply a fraction of a unit.

1. Enter the quantity with the decimal point; press the **X/TIME** key. For example, for \$3.75 of produce, enter:

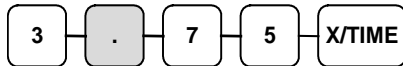

2. Enter the PLU number; press the **PLU** key.
For example, enter:



THANK-YOU CALL AGAIN		
05/01/2019 WED		08:33
3.75X	@2.99	
PLU3 T1		\$11.21
TAX1		\$0.67
TOTAL		\$11.88
CASH		\$11.88
CLERK 01	000011	00001

Split Pricing Code Entry PLU

When items are priced in groups, i.e. 3 for \$1.00, you can enter the quantity purchased and let the register calculate the correct price.

1. Enter the quantity purchased, press the **X/TIME** key. For example, enter:



2. Enter the quantity of the group price, press the **X/TIME** key. For example, if the items are priced 3 for \$1.00, enter:

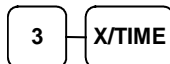

3. Enter the PLU number; press the PLU key. For example, enter:



THANK-YOU		
CALL AGAIN		
05/01/2019 WED		
08:33		
2@3FOR	@2.99	
PLU3 T1		\$1.99
TAX1		\$0.12
TOTAL		\$2.11
CASH		\$2.11
CLERK 01	000011	00001

PLU Price Inquiry

You can check the price of a PLU without registering the PLU by placing a price inquiry function key on the keyboard.

1. Press the **PRICE INQ** key. The message "PRICEINQ" displays:



2. Press a preset PLU key, or enter a PLU number and press the PLU key:

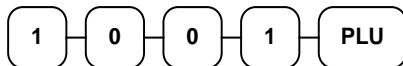

3. The PLU descriptor and price display on the screen. If the PLU has prices at more than one price level, all prices will be shown.
4. Press **CLEAR** to remove the price information from the screen or enter the PLU again to register the item.

SCREEN EXAMPLE:

HAMBURGER
1 : 1.25

Modifier Key

Pressing a modifier key alters the next PLU registered, either by changing the code number of the PLU so that a different item is registered, or by just adding the modifier descriptor and registering the same PLU. See “MODIFIER 1-5” in the “*Program Mode Programming*” chapter in order to determine how the modifier key will affect the PLU entry.

Modifiers can be:

- *Stay Down* - so that registrations will be modified by the same modifier until another modifier is selected,
- *Pop-Up after each item* - to register, for example large, medium or small soft drink, or
- *Pop-Up after each transaction* - to register the same modification for the item until the transaction is finalized.

See the “SYSTEM Options” settings in “*Options Programming*” in the “*Program Mode Programming*” chapter to select stay down/pop-up status.

Pop-Up Modifier Key Affecting PLU Code

1. Press a preset PLU key. For example, press **PLU 1** with a price of \$1.00.



2. Press the **MOD 1** key. The message "MOD1" displays.



3. Press the same PLU key. In this example the modifier 1 will add the digit 1 to the fourth PLU # position, resulting in the registration of PLU #1001.

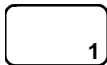

4. Press another PLU key. In this example press **PLU 2** with a price of \$1.50.

THANK-YOU CALL AGAIN		
05/01/2019 WED		08:33
PLU1		\$1.00
MOD1		
#1001		\$1.25
PLU2		\$1.50
TOTAL		\$3.75
CASH		\$3.75
CLERK 01	000011	00001

Price Level Key

If you choose to use the price level feature, you must allocate memory for each level. See "ALLOCATION" in the "Service Mode Programming" chapter. Note that the default program selects one price level. You must also place price level keys on the keyboard. See "Function Key Assignment" in the "Service Mode Programming" chapter.

If you use this feature, the same PLU can be given up to 2 different preset prices. Price Level keys shift the price that is being registered. Levels can be:

- *Stay Down* - so that registrations will stay in the selected level until another level is selected,
- *Pop-Up after each item* - to register, for example large, medium or small soft drink,
- *Pop-Up after each transaction* - to register the same level until the transaction is finalized.

See "SYSTEM Options" of "Options Programming" in the "Program Mode Programming" chapter to set how the price level keys operate.

Pop-Up Price Level Keys

1. Press a preset PLU key. For example, press PLU **1** programmed with a price of \$1.00 for price level 1.



2. Press the **LEVEL 2** key. The message "LEVEL 2" displays.



3. Press the same PLU key. In this example the PLU 1 key is programmed with a price of \$2.00 for price level 2.



4. Press another PLU key. In this example press PLU **2** programmed to register PLU #2 with price level 1. Note that the level 1 price is registered.

THANK-YOU		
CALL AGAIN		
05/01/2019 WED		08:33
PLU1		\$1.00
PLU1		\$2.00
PLU2		\$1.50
TOTAL		\$4.50
CASH		\$4.50
CLERK 01	000011	00001

Promo

The **PROMO** key allows you to account for promotional items, as in "buy two, and get one free". Pressing this key will remove an item's cost from the sale, and the promo item will not be added to the PLU sales total, but it is added to the item sales counter. If stock (inventory) reporting is used, the item will be subtracted from inventory.

1. Register an item. For example, press PLU **1** programmed with a price of \$1.00 for price level 1.

1

2. Press the **PROMO** key. The message "PROMO" displays.

PROMO

3. Enter the item you want to promo. (*You cannot enter an item that has not been already registered in this transaction.*)

1

```
THANK-YOU
CALL AGAIN

05/01/2019 WED      08:33

PLU1                $1.00
***PROMO***

PLU1
TOTAL                $0.00
CASH                 $0.00
CLERK 01           000011 00001
```

Waste

The **WASTE** key allows control of inventory by accounting for items that must be removed from stock due to spoilage, breakage or mistakes. Press the **WASTE** key before entering wasted items, and then press the **WASTE** key again to finalize. The **WASTE** key may be under manager control, requiring the mode to be in the **MANAGER MODE**. The **WASTE** key is not allowed within a sale.

1. Press the **WASTE** key. The message "WASTE" displays at the top of the screen.

WASTE

2. Enter the item or items that are wasted.
3. Press the **WASTE** key again to total the wasted items:

WASTE

```
THANK-YOU
CALL AGAIN

05/01/2019 WED      08:33

***WASTE***

PLU1                $1.25
PLU2                $1.50
***WASTE***

TOTAL                $2.75
CLERK 01           000011 00001
```

Shifting or Exempting Tax

Shifting Tax

PLU's can be programmed to automatically add the appropriate tax or taxes. Occasionally, you may need to sell a normally taxable item without tax, or a normally non-taxable item with tax. You can perform this tax shifting with one of the four tax shift keys.

1. Press the tax shift for the tax you wish to shift. For example, Press **TAX SHIFT 1**:

**TAX 1
SHIFT**

2. Enter an amount on the ten-key pad. *Do not use the decimal key.* For example, for \$2.99, enter:

2 9 9

3. Press a PLU key. For example, press PLU **1**. If PLU **1** is normally taxable by tax 1, the registration will be non-taxable.

1

THANK-YOU		
CALL AGAIN		
05/01/2019 WED		08:33
PLU1		\$2.99
TOTAL		\$2.99
CASH		\$2.99
CLERK 01	000011	00001

Exempting Tax

Occasionally, you may need to exempt tax from an entire sale. For example, you might remove all state and local taxes when you sell merchandise to a church or charitable institution.

You can exempt tax by using the tax shift keys and the **SUBTOTAL** key, or you can use the **TAX EXMT** (tax exempt) function key.

Exempting Tax with Tax Shift Keys

1. Enter an amount on the ten-key pad. *Do not use the decimal key.* For example, for \$2.99, enter:

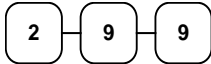

2. Press a taxable PLU key. For example, press PLU 1:

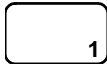

3. Press **SUBTOTAL**:

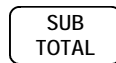

4. Press the tax shift key (or keys) that represents the tax you wish to shift. For example, to exempt tax 1 press **TAX SHIFT 1**, then press **SUBTOTAL**:



5. The display reflects the transaction without added taxes; Total the sale with **CASH**, **CHECK**, or **CHARGE**. The sale will not include Tax1.

THANK-YOU		
CALL AGAIN		
05/01/2019 WED		08:33
PLU1 T1		\$2.99
TOTAL		\$2.99
CASH		\$2.99
CLERK 01	000011	00001

Exempting Tax with the Tax Exempt Key

You can program the **TAX EXEMT** function to remove all or selected taxes.

1. Enter an amount on the ten-key-pad. *Do not use the decimal key.* For example, for \$2.99, enter:

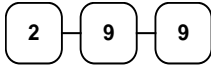

2. Press a taxable PLU key. For example, press **PLU 1**:



3. Press **SUBTOTAL**:

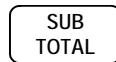

4. Press the **TAX EXMT** key (or access the **TAX EXMT** function from a function look up menu key):



5. The display reflects the transaction without added taxes. Total the sale with **CASH**, **CHECK**, or a **CHARGE** function. The sale will not include tax1.

THANK-YOU		
CALL AGAIN		
05/01/2019 WED		08:33
PLU1 T1		\$2.99
TOTAL		\$2.99
CASH		\$2.99
CLERK 01	000011	00001

Percent Key Operations

A total of five % functions are available. (%1) is located on the default keyboard of the HK-7200 Series. Each function is individually programmable to add or subtract, from an individual item or from a sale total, amounts (coupons) or percentages. You can also program the percentage key taxable or non-taxable, so that sales taxes are calculated on the net, or the gross amount of the item or sale. You can also program preset prices or percentages.

The operation examples in this section show the percentage key in a variety of configurations. See "Function Key Programming" in the "Program Mode Programming" chapter to assign a specific function to each percentage key.

Preset Percent Discount on an Item

In this example the %1 function is preset with a rate of 10 %.

1. Register the item.
2. Press the %1 key:

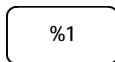

3. The discount is automatically subtracted.

THANK-YOU CALL AGAIN		
05/01/2019 WED		08:33
PLU2		\$10.00
% 1		-10.000%
AMOUNT		-1.00
TOTAL		\$9.00
CASH		\$9.00
CLERK 01	000011	00001

Enter a Percent Discount on an Item

You can also operate the percentage functions by entering the percentage of the discount or surcharge. If necessary, you can enter a fractional percentage up two 3 digits beyond the decimal (i.e. 99.999%).

1. Register the discounted item.
2. Enter the percentage. If you are entering a fraction of a percent, you must use the decimal key. For example, for one third off enter:



3. Press the %1 key:

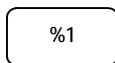

4. The discount is automatically subtracted.

THANK-YOU CALL AGAIN		
05/01/2019 WED		08:33
PLU2		\$10.00
% 1		-33.333%
AMOUNT		-3.33
TOTAL		\$6.67
CASH		\$6.67
CLERK 01	000011	00001

Percent on Sale Total

The percent can be an open or preset amount. In this example an open percentage surcharge of 15% is applied.

1. Register the items you wish to sell.
2. Press the **SUBTOTAL** key:



3. Enter the percentage, press the appropriate discount key. For example, for 15% enter:

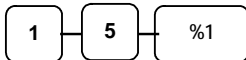

4. The surcharge is automatically added.

THANK-YOU		
CALL AGAIN		
05/01/2019 WED		08:33
PLU2		\$10.00
% 1		15.000%
AMOUNT		\$1.50
TOTAL		\$11.50
CASH		\$11.50
CLERK 01	000011	00001

Coupon on Sale (Vendor Coupon)

When programmed as "amount", "sale", "open" and "negative", a % key will perform a coupon against a sale (or vendor coupon.) Also, depending upon programming:

- You may be allowed to enter only one coupon in a sale, after the **SUBTOTAL** key is pressed,
- You may be allowed to enter multiple coupons, but you must press the **SUBTOTAL** key before each coupon entry, or
- You may be allowed to enter multiple coupons, without first pressing **SUBTOTAL**.

In this example, a coupon may be entered only once, and you must first press **SUBTOTAL**.

1. Register the items you wish to sell.
2. Press the **SUBTOTAL** key:

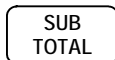

3. Enter the amount of the coupon, press the appropriate % key. For example:

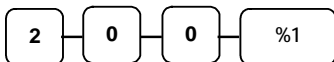

4. The coupon is subtracted.

THANK-YOU		
CALL AGAIN		
05/01/2019 WED		08:33
PLU2		\$10.00
%1		-2.00
TOTAL		\$8.00
CASH		\$8.00
CLERK 01	000011	00001

Coupon on Item (Store Coupon)

When programmed as "amount", "item", "open" and "negative", a % key will perform a coupon against an item (or store coupon.) In this case, you must press the PLU (or enter the PLU number) of the PLU you wish the coupon to be subtracted from.

1. Register the items you wish to sell.
2. Enter the amount of the coupon, press the appropriate % key. For example:

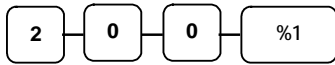

3. Press the PLU key you wish to subtract the coupon from (or enter the PLU number of the PLU you wish to subtract the coupon from and press **PLU**.)

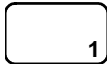

4. The coupon is automatically subtracted.

THANK-YOU		
CALL AGAIN		
05/01/2019 WED	08:33	
PLU1		\$10.00
PLU1 C		-2.00
TOTAL		\$8.00
CASH		\$8.00
CLERK 01	000011	00001

Return Merchandise Registrations

If you wish to return or refund an item, press **MDSE RETURN**, then re-enter any item. You can return merchandise as part of a sale, or you can return merchandise as a separate transaction and return cash to the customer.

1. Press **RETURN**:



2. Enter the price of the item you wish to return, then press the PLU key where it was registered originally.

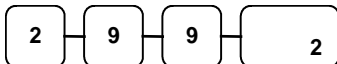

3. Total the sale with **CASH**, **CHECK**, or a **CHARGE** function.

THANK-YOU		
CALL AGAIN		
05/01/2019 WED	08:33	
***** RETURN *****		
PLU2 T1		-2.99
TAX1 AMT		-0.18
TOTAL		-3.17
CASH		-3.17
CLERK 01	000011	00001

Voids and Corrections

Error Correction (Void Last Item)

This function corrects the last item entered.

1. Register the item you wish to sell.
2. Press the **ERROR CORR** key:

ERROR
CORR

THANK-YOU CALL AGAIN		
05/01/2019 WED		08:33
PLU1 T1		\$2.29
PLU2		\$1.29
ERR CORR	-----	
PLU2		-1.29
TAX1 AMT		\$0.14
TOTAL		\$2.43
CASH		\$2.43
CLERK 01	000011	00001

Void Previous Item

This function allows you to correct an item registered previously in a transaction.

1. Register an item. Then register a second item.
2. To correct the first item, press **VOID**:

VOID

3. Enter the price of the first item; then press the PLU key where it was registered originally.

1 2 9 2

THANK-YOU CALL AGAIN		
05/01/2019 WED		08:33
PLU2		\$1.29
PLU1 T1		\$2.29
VOID	-----	
PLU2		-1.29
TAX1 AMT		\$0.14
TOTAL		\$2.43
CASH		\$2.43
CLERK 01	000011	00001

Cancel

The **CANCEL** key allows you to stop any transaction. Anything registered within the transaction before the **CANCEL** key is pressed is automatically corrected. The **CANCEL** key can be inactivated through programming, see "Function Key Programming" in the "*Program Mode Programming*" chapter, or the key can be programmed to require manager control.

1. Register the items you wish to sell.
2. Press the **CANCEL** key.

CANCEL

```
THANK-YOU
CALL AGAIN

05/01/2019 WED                08:33

PLU1 T1                        $2.29
PLU2                            $1.50
CANCEL *****
CLERK 01                000011  00001
```

VOID MODE Operations

You can use the **VOID MODE** to correct any complete transaction. To correct any transaction:

1. Move to the **VOID MODE**.
2. Enter the transaction you wish to correct exactly as it was entered originally in the **REGISTER MODE**. You can enter discounts, voids, returns, tax exemptions or any other function.
3. All totals and counters are corrected as if the original transaction did not take place.

```
THANK-YOU
CALL AGAIN

05/01/2019 WED                08:33

***** VOID MODE *****
PLU1 T1                        -2.29
PLU2                            -1.00
TAX1 AMT                        -0.14
TOTAL                          -3.43
CASH                            -3.43
CLERK 01                000011  00001
```

No Sale Operations

Open Drawer

The **#/NO SALE** key will open the cash drawer when you have not already started a transaction. The no sale function can be disabled or placed under manager control through programming, see "Function Key Programming" in the "*Program Mode Programming*" chapter.

1. Press **#/NS**:



2. The drawer will open, and the receipt will print as in the example on the right.

```
THANK-YOU
CALL AGAIN

05/01/2019 WED           08:33

NO SALE -----
CLERK 01           000011  00001
```

Non Add Number

You can also use the **#/NO SALE** key to print any number (up to 9 digits) on the printer paper. You can enter the number any time during a transaction. For example, if you wish to record a checking account number, enter the number and press the **#/NO SALE** key before totaling the sale with the **CHECK** key.

1. Register the items you wish to sell.
2. Enter the number you wish to record, for example enter:

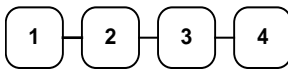

3. Press **#/NS**:



4. Press **CHECK**:



```
THANK-YOU
CALL AGAIN

05/01/2019 WED           08:33

PLU1 T1                   $2.99
NON-ADD#                   123456789
TAX1 AMT                   $0.18
TOTAL                   $3.17
CHECK                   $3.17
CLERK 01           000011  00001
```

Received On Account Operations

You can use one of the received on account functions (**RA1-RA3**) to accept cash or checks into the cash drawer when you are not actually selling merchandise. For example, use received on account to accept payments for previously sold merchandise or record loans to the cash drawer.

1. Press one of the received on account keys (**RA1-RA3**).

RA1

2. Enter the amount of cash received, press **CASH**.

1 0 0 0 CASH

3. Enter the check amount received, press **CHECK**.

1 0 0 0 CHECK

4. Enter the charge amount received, press **CHARGE**.

1 0 0 0 CHARGE

5. You can continue to itemize receipts, or you can finalize by pressing or selecting the same received on account key.

RA1

THANK-YOU			
CALL AGAIN			
05/01/2019 WED		08:33	
RA1			
CASH		\$10.00	
CHECK		\$10.00	
CHARGE		\$10.00	
RA1		\$30.00	
CLERK 01	000011	00001	

Paid Out Operations

You can use the **PAID OUT** function to track cash or checks paid out or to record loans from the cash drawer.

1. Press one of the paid out keys (**PO1-PO3**).

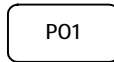

2. Enter the amount of cash paid out, press **CASH**.

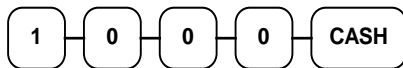

3. Enter the check amount paid out, press **CHECK**.

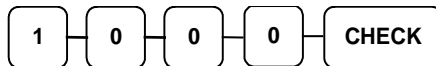

4. You can continue to itemize paid outs, or you can finalize by pressing or selecting the same paid out key.

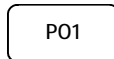

THANK-YOU			
CALL AGAIN			
05/01/2019 WED		08:33	
PO1			
CASH			-10.00
CHECK			-10.00
PO1			-20.00
CLERK 01	000011	00001	

Subtotaling a Sale

1. Register the items you wish to sell.
2. Press **SUBTOTAL**. The subtotal will display with the message "SUBTOTAL" indicated on the rear display.

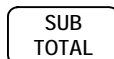

The subtotal can be printed if the print option is set. See "PRINT Options" of "Options Programming" in the "Program Mode Programming" chapter.

Eat-In, Take Out and Drive Thru

Different types of sales such as "Eat In", "Take Out" and "Drive Thru" can be categorized by placing the separate destination keys on the keyboard. **Eat-In, Take Out and Drive Thru** keys function as subtotal keys. Separate totals will be maintained on the financial report to detail sales counts and amounts for each key.

Note: Eat-In, Take-Out and Drive-Thru keys can be programmed to exempt taxes to accommodate areas where food is taxed differently.

Totaling and Tendering

There are ten tender functions available to categorize sales. **CASH** and **CHECK** are individual keys on the keyboard.

Depending upon how your register is programmed you might find charge keys as individual function keys on the keyboard.

Totaling a Cash Sale

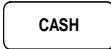
1. Register the items you wish to sell.
2. To total a cash sale, press **CASH**:

3. The display will indicate the total amount of the cash sale.

THANK-YOU CALL AGAIN		
05/01/2019 WED		08:33
PLU2		\$7.96
TOTAL		\$7.96
CASH		\$7.96
CLERK 01	000011	00001

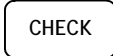
Totaling a Check Sale

1. Register the items you wish to sell.
2. To total a cash sale, press **CHECK**:

3. The display will indicate the total amount of the cash sale.

THANK-YOU CALL AGAIN		
05/01/2019 WED		08:33
PLU2		\$7.96
TOTAL		\$7.96
CHECK		\$7.96
CLERK 01	000011	00001

Tendering a Cash Sale

1. Register the items you wish to sell.
2. Enter the amount tendered by the customer. For example, for \$20.00 enter:

2 0 0 0

3. Press **CASH**:

CASH

4. The display will indicate the total amount of the cash tendered and the change due, if any.

THANK-YOU CALL AGAIN		
05/01/2019 WED		08:33
PLU1 T1		\$2.99
PLU1 T1		\$2.99
4X	@1.99	
PLU2		\$7.96
TAX1		\$0.36
TOTAL		\$14.30
CASH		\$20.00
CHANGE		\$5.70
CLERK 01	000011	00001

Tendering a Check Sale

1. Register the items you wish to sell.
2. Enter the amount tendered by the customer. For example, for \$20.00 enter:

2 0 0 0

3. Press **CHECK**:

CHECK

4. The display will indicate the total amount of the check tendered and the change due, if any.

THANK-YOU CALL AGAIN		
05/01/2019 WED		08:33
PLU1 T1		\$2.99
PLU1 T1		\$2.99
4X	@1.99	
PLU2		\$7.96
TAX1		\$0.36
TOTAL		\$14.30
CHECK		\$20.00
CHANGE		\$5.70
CLERK 01	000011	00001

Totaling a Charge Sale

Use the charge keys to track charge or credit card sales. See "Function Key Programming" in the "Program Mode Programming" chapter to change the descriptors for the charge tender functions. For example, you can use CHARGE 1 to track Visa card sales. The descriptor "VISA" will display on the screen and print on the printer. You can also set tendering options for the charge keys, i.e. whether to allow over tendering or to enforce tendering.

1. Register the items you wish to sell.
2. Press one of the charge key if it is located on the keyboard:

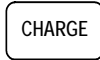

THANK-YOU CALL AGAIN		
05/01/2019 WED		08:33
PLU1 T1		\$2.99
PLU1 T1		\$2.99
4X	@1.99	
PLU2		\$7.96
TAX1		\$0.36
TOTAL		\$14.30
CHARGE		\$14.30
CLERK 01	000011	00001

Tendering a Charge Sale

Tendering a charge sale may or may not be allowed. See "Function Key Programming" in the "Program Mode Programming" chapter to set tendering options for the charge keys, i.e. whether to allow over tendering or to enforce tendering.

1. Register the items you wish to sell.
2. Enter the amount of the charge and press one of the charge keys if it is located on the keyboard:

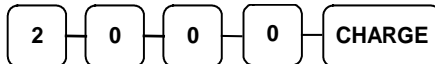

THANK-YOU CALL AGAIN		
05/01/2019 WED		08:33
PLU1 T1		\$2.99
PLU1 T1		\$2.99
4X	@1.99	
PLU2		\$7.96
TAX1		\$0.36
TOTAL		\$14.30
CHARGE		\$20.00
CHANGE		\$5.70
CLERK 01	000011	00001

Check Cashing

Check cashing means exchanging cash for a check. If you wish to cash checks, you must place a **CHKCASH** key on the keyboard. See "Function Key Assignment" in the "Service Mode Programming" chapter.

1. Enter the amount of the check tendered by the customer. For example, for \$20.00 enter:



2. Press **CHKCASH**:

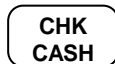

3. The display will indicate the amount of the check and the cash change.

THANK-YOU		
CALL AGAIN		
05/01/2019 WED	08:33	
CHKCASH		
CHECK		\$20.00
CASH		-20.00
CLERK 01	000011	00001

Split Tender

Split tendering is paying for one transaction by more than one payment method. For example, a \$20.00 sale could be split so \$10.00 is paid in cash, and the remaining \$10.00 is paid by a check. If necessary, you can make several different payments.

Note: By default, CASH and/or CHECK under tenders are allowed. This can be changed through function key programming.

1. Register the items you wish to sell.
2. Enter the amount of cash tendered by the customer. For example, enter \$10.00 and press **CASH**:

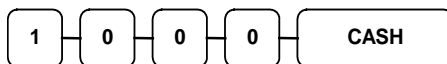

The display will indicate the \$10.00 cash tender and the \$10.00 total still due.

3. Enter the amount of check tendered by the customer. For example, enter \$10.00 and press **CHECK**:

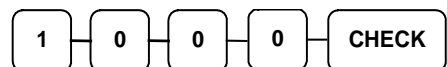

4. When the total tendered equals or exceeds the total due, the receipt will print, and the transaction is complete.

THANK-YOU		
CALL AGAIN		
05/01/2019 WED	08:33	
PLU2		\$20.00
TOTAL		\$20.00
CASH		\$10.00
TOTAL		\$10.00
CHECK		\$10.00
CLERK 01	000011	00001

Post Tender

Post tendering means computing change after the sale has been totaled and the drawer is open. This feature is useful when a customer changes the amount of the tender or when a "quick change artist" confuses a clerk. Normally, this function is not allowed. If you wish to allow post tendering, you must set the appropriate options program. See "SYSTEM Options" of "Options Programming" in the "Program Mode Programming" chapter. (A separate system option determines whether the drawer opens on the post tender.)

1. Register the items you wish to sell.
2. Press **CASH**:

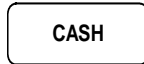

3. The display will indicate the total of the cash sale.
4. Enter the amount of the new tender, Press **CASH**:



5. The display will indicate the change due.

THANK-YOU CALL AGAIN		
05/01/2019 WED		08:33
PLU1 T1		\$2.00
TAX1		\$0.12
TOTAL		\$2.12
CASH		\$2.12
CLERK 01	000011	00001

Receipt On/Off and Receipt on Request

When a receipt is not normally issued, you can turn the receipt function off. See "Receipt On/Off" in the "Manager Mode (X Mode)" chapter.

If the receipt is off, you can still issue a receipt after the sale has been completed.

Printing a Receipt after the Sale

After the sale has been totaled, but before the next transaction is started, press **CASH**:

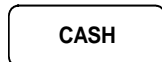

Currency Conversion

If you normally accept currency from neighboring nations, you can program the HK-7200 Series to convert the subtotal of a sale to the equivalent cost in the foreign currency. You can set up to four separate conversion functions for different foreign currencies. To do this, you need to program the conversion factor. For example, if the US dollar (home currency) is worth 1.3720 Canadian dollars (foreign currency), the conversion factor is 1.3720. See "Function Key Programming" in the "Program Mode Programming" chapter to set a conversion factor.

1. Register the items you wish to sell.
2. Press the **CONV1** key if it is located on the keyboard:

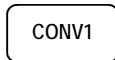

3. The amount due in foreign currency is displayed.
4. Enter the amount of the foreign currency tender, Press **CASH**:



5. The display will indicate the amount of foreign currency tendered and display \$5.17 change due. **The change due is computed in home currency!**

THANK-YOU CALL AGAIN		
05/01/2019 WED		08:33
PLU1 T1		\$2.00
TAX1		\$0.12
TOTAL		\$2.12
CONV 1		¥2.90
CHANGE RATE		@1.3720
HOME AMT.		\$10.00
CHANGE		\$5.17
CLERK 01	000011	00001

The currency symbol you program will display here.
See "System Options → PRINT Options" in the "Program Mode Programming" chapter.

Scale Operations

The HK-7200 Series can be interfaced to an optional load-cell scale. The scale interface allows direct entry of an item's weight using the **SCALE** function. You can also choose "manual entry" scale operation if you are working with a standalone scale that is not interfaced to the cash register.

- PLU's must be set to "scalable" status to allow scale multiplication. If you attempt an entry into a PLU that has been programmed "scalable", an error tone will sound and the message "REQ SCALE" will display.
- PLU's can be set to "auto scale" status to speed up scale entries by automatically retrieving the weight on the scale and multiplying it times the amount entered.

A tare is the amount of weight accounted for by the container or packaging. By entering a tare weight (as required by law in some areas) the weight of the container is subtracted and only the true weight of the product is measured on the scale. By entering the tare number (1-5) the operator can automatically subtract the predetermined container weight when a product is on the scale.

- PLU's can be set to "auto tare" status to automatically subtract one of the preprogrammed tare weights when the PLU is registered.

Refer to the "*Service Mode Programming*" and "*Program Mode Programming*" chapters to set your scale options. See:

- "Define Port" to attach a scale to one of the ports.
- "Function Key Assignment" to place SCALE and TARE keys on the keyboard.
- "Function Key Programming" to set options for the SCALE and TARE keys.
- "PLU Programming" to set scalable, auto scale, or auto tare status.

Direct Scale Entry

Place a product on the scale and access the **SCALE** function to display the weight on the cash register. Then make the appropriate entry; the PLU must have "scalable" status setting.

1. Place an item on the scale.
2. Press the **SCALE** key.



3. Note that the weight is displayed on the screen. Enter the price per pound on the ten-key pad. *Do not use the decimal key.* For example, for \$3.00, enter:

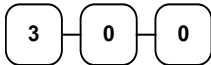

4. Press a PLU key. For example, press **PLU 1**:



THANK-YOU CALL AGAIN		
05/01/2019	WED	08:33
1.50 lb	@3.00/lb	
PLU1		\$4.50
TAX1		\$0.27
TOTAL		\$4.77
CASH		\$4.77
CLERK 01	000011	00001

Automatic Scale Entry

Place a product on the scale and make the appropriate PLU entry. The PLU must be set as "scalable" and "auto scale" in the PLU status settings.

1. Place an item on the scale.
2. Press a PLU key, if the item is a preset item, or enter the price per pound on the ten-key pad. *Do not use the decimal key.* For example, for \$3.00, enter:

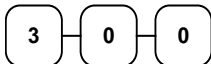

3. Press a PLU key. For example, press **PLU 1**:

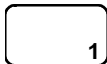

THANK-YOU CALL AGAIN		
05/01/2019	WED	08:33
1.50 lb	@3.00/lb	
PLU1		\$4.50
TAX1		\$0.27
TOTAL		\$4.77
CASH		\$4.77
CLERK 01	000011	00001

Tare Weight Entry

1. Place an item on the scale.
2. Enter the preprogrammed tare number.
Press the **TARE** key.



3. Press the **SCALE** key.



4. Note that the weight, less the tare weight, is displayed on the screen. Enter the price per pound on the ten-key pad. *Do not use the decimal key.* For example, for \$3.00, enter:

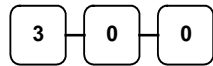

5. Press a PLU key.
For example, press **PLU 1**:

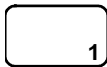

THANK-YOU CALL AGAIN		
05/01/2019 WED		08:33
1.50 lb	@3.00/lb	
PLU1		\$4.50
TAX1		\$0.27
TOTAL		\$4.77
CASH		\$4.77
CLERK 01	000011	00001

Manual Tare Weight Entry

1. Place an item on the scale.
2. Enter the manual tare number, **5**. Press the **TARE** key:



3. Enter the weight of the tare, for example, enter **.01**, press the tare key:

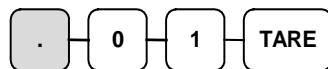

4. Press the **SCALE** key.



5. Note that the weight, less the tare weight, is displayed on the screen. Enter the price per pound on the ten-key pad. *Do not use the decimal key.* For example, for \$3.00, enter:

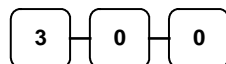

6. Press a PLU key.

For example, press **PLU 1**:

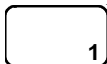

THANK-YOU CALL AGAIN		
05/01/2019 WED		08:33
1.50 lb	@3.00/lb	
PLU1		\$4.50
TAX1		\$0.27
TOTAL		\$4.77
CASH		\$4.77
CLERK 01	000011	00001

Manual Weight Entry

Note: Manual weight entry is allowed only when a scale is not connected, and the Serial port is not set to the scale function. Manual Weight is also used when voiding or returning a scale item without using the scale.

Operators can make manual weight entries if the item has been programmed to accept them. You must use the decimal key to enter fractional manual weights.

1. Place an item on the scale.
2. Enter the weight using the decimal key for fractional weights. Press the **SCALE** key:

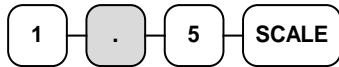

3. Enter the price per pound on the ten-key pad. *Do not use the decimal key.* For example, for \$3.00, enter:

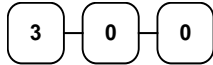

4. Press a PLU key.
For example, press **PLU 1**:

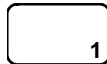

THANK-YOU		
CALL AGAIN		
05/01/2019 WED		08:33
1.500 lb	MANUAL WT. @3.00/lb	
PLU1		\$4.50
TAX1		\$0.27
TOTAL		\$4.77
CASH		\$4.77
CLERK 01	000011	00001

Check Tracking Operations

Overview

The HK-7200 Series can employ a manual previous balance, hard check, or soft check system. (You must select hard or soft check posting in memory allocation programming - the default selection is soft.)

- If manual previous balance is selected, the check balance is not saved in memory and is input manually by the operator (use the **PBAL** key).
- If a hard check system is selected, only the previous balance is maintained in memory.
- If a soft check system is selected, the check detail is kept in memory until the check is paid. (The maximum size of the soft check is set in memory allocation programming.)

Options

For hard or soft check operations, the following tracking options are available:

- Tracking by manually entering the check number. (The number of digits in the check number may be set from 0-9, with zero meaning no fixed length.)
- Tracking by automatically assigning a check number. The starting check is always #1.
- Enforcing entry of a table number, where a check number is also assigned, allows the check balance to be recalled by either the check or table number. Multiple checks may be assigned at the same table. (If there are multiple checks assigned to the same table, an attempt to recall by table number will recall the check with the lowest number.)
- The check number can be scanned from a printed bar code. For example, a bar code can be printed on a customer identification badge.

For soft check operations, the following option is available:

- Consolidation of like items can be selected for guest check printing. For example, if three rounds of drinks are served, the check will print "3 TAP BEER" rather than "1 TAP BEER" three times.

Function Keys for Check Tracking

Although none of the functions necessary for check tracking operations appear on the default keyboard, any or all of the following functions can be located on the keyboard:

CHECK #	<p>The CHECK # key is used to begin a new or access an existing balance (hard check) or itemized bill (soft check.)</p> <p>Check track numbers that are entered manually may be set at a fixed length of one to nine digits. Check track numbers assigned automatically will begin with #1.</p> <p>Existing checks are accessed by entering the check track number and pressing the CHECK# key. In a drive thru system, simply pressing the PBAL key will recall the oldest open balance (lowest check track#).</p>
GUEST	<p>Use to enter the count of guests served as part of a guest check. The entry of a guest count can be enforced when opening a guest check, or for all transactions.</p>
P/BAL	<p>Use to enter the amount of an outstanding balance. The P/BAL key will take the recall function if the <i>drive thru</i> feature is enabled in CHECK # key programming.</p>
SERVICE	<p>Use to temporarily finalize Previous Balance or check tracking transactions. (If you are using a hard check system, you must program the SERVICE key for the port where the slip printer is connected.)</p>
TABLE	<p>You can enforce the entry of a table number for guest check transactions, or for all transactions. If you are tracking guest check balances, the balance can be recalled either by entering the check number or the table number.</p>
PRINT CHECK	<p>Use to print a guest check. The check can be printed on an optional (RS-232C) printer or can be printed on the receipt printer. The PRINT CHECK key can be set to automatically service the check.</p>
TIP	<p>The TIP key allows a gratuity to be added to a guest check before payment. The tip amount is deducted from the Cash-in-Drawer amount for the Clerk/Cashier closing the guest check.</p> <p>The TIP key may be programmed as either a percentage or amount. If programmed as a percentage, tax programming defines whether the percentage is calculated on the net (taxable = no) amount, or the amount after taxes.</p>

See "Function Key Assignment" in the "Service Mode Programming" chapter to place the functions necessary for your application. See "Function Key programming" in the "Program Mode Programming" chapter to set the options for each function.

Posting Balances Manually

Opening a Check

1. Enter the previous balance (if this is the first posting, enter **0**) press the **PBAL** key:

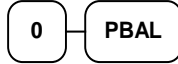

2. Register the items you wish to sell.
3. To total the posting, press **SERVICE**:



4. Place a slip in an optional slip printer, press the **PRINT CHECK** key.

THANK-YOU CALL AGAIN			
05/01/2019	WED		08:33
PBAL			\$0.00
PLU2			\$1.00
SERVICE			\$1.00
BFD			\$1.00
CLERK 01	000011	00001	

Adding to a Check

1. Enter the previous balance, press the **PBAL** key:

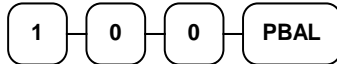

2. Register the next items you wish to sell.
3. To total the posting, press **SERVICE**:



4. Place a slip in an optional slip printer, press the **PRINT CHECK** key.

THANK-YOU CALL AGAIN			
05/01/2019	WED		08:33
PBAL			\$1.00
PLU3			\$2.00
SERVICE			\$2.00
BFD			\$3.00
CLERK 01	000011	00001	

Paying a Manual Balance

1. Enter the previous balance, press the **PBAL** key:

3 0 0 PBAL

2. If necessary, add additional items. If you wish to add a tip, press **SUBTOTAL**, then enter the tip amount and press the **TIP** key:

SUB
TOTAL

5 0 TIP

3. Pay the balance as you would normally tender a transaction, with **CASH**, **CHECK**, or one of the **CHARGE** functions. If the tender is greater than the balance due, change is displayed:

1 0 0 0 CASH

4. Place a slip in an optional slip printer, press the **PRINT CHECK** key.

THANK-YOU		
CALL AGAIN		
05/01/2019 WED		08:33
PBAL		\$3.00
TIP		\$0.50
CHECKS PAID		\$3.50
CASH		\$10.00
CHANGE		\$6.50
CLERK 01	000011	00001

Soft Check

Opening a Soft Check

1. Enter the number of the guest check, press the **CHECK #** key:

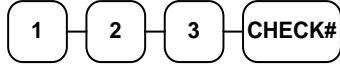

or, press the **CHECK #** key to automatically assign a check:



2. If required, enter the table number and press the **TABLE** key:



3. If required, enter the number of guests and press the **GUEST** key:

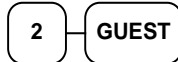

4. Register the items you wish to sell.
5. To total the posting, press **SERVICE**:



Receipt Example:

THANK-YOU			
CALL AGAIN			
05/01/2019	WED		08:33
CHECK #			#123
TABLE			#3
GUEST			#2
CHICKEN			\$7.00
STEAK			\$10.00
SERVICE			\$17.00
BFWD			\$17.00
CLERK 01		000011	00001

Note: If a table number entry is required for all guest checks, and checks are assigned by register, the check will be assigned by the register when the table # is entered.

Adding to a Soft Check

1. Enter the number of the guest check, press the **CHECK #** key:

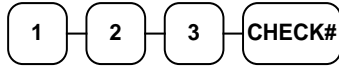

or, if you entered a table number, enter the table number and press the **TABLE** key:



2. Register the next items you wish to sell.
3. To total the posting, press the **SERVICE** key.



Receipt Example:

THANK-YOU CALL AGAIN		
05/01/2019 WED	08:33	
CHECK #	#123	
TABLE	#3	
GARLIC BREAD	\$2.00	
SERVICE	\$2.00	
BFWD	\$19.00	
CLERK 01	000011	00001

Printing a Soft Check

1. Enter the number of the guest check, press the **CHECK #** key:

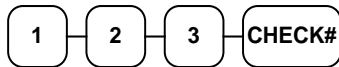

or, if you entered a table number, enter the table number and press the **TABLE** key:



2. Press **PRINT CHECK** to print the complete check. If programmed to do so, the **PRINT CHECK** key will automatically service the check:



Sample of soft check printed on an optional printer:

THANK-YOU CALL AGAIN		
05/01/2019 WED	08:33	
CHECK #	#123	
TABLE	#3	
CHICKEN	\$7.00	
STEAK	\$10.00	
GARLIC BREAD	\$2.00	
SERVICE	\$0.00	
BFWD	\$19.00	
CLERK 01	000011	00001
	CHK # :	1

The number of times each check has been printed is counted and printed on the check

Paying a Soft Check

1. Enter the number of the guest check, press the **CHECK #** key:

1 — 2 — 3 — **CHECK#**

or, if you entered a table number, enter the table number and press the **TABLE** key:

3 — **TABLE**

2. If necessary, add additional items. If you wish to add a tip, press **SUBTOTAL**, then enter the tip amount and press the **TIP** key:

SUB
TOTAL

3 — 0 — 0 — **TIP**

3. Pay the balance as you would normally tender a transaction, with **CASH**, **CHECK**, or one of the **CHARGE** functions. If the tender is greater than the balance due, change is displayed.

2 — 5 — 0 — 0 — **CASH**

Sample of soft check printed on the receipt:

THANK-YOU	
CALL AGAIN	
05/01/2019 WED	08:33
CHECK #	#123
TABLE	#3
TIP	\$3.00
CHECKS PAID	\$22.00
TOTAL	\$22.00
CASH	\$25.00
CHANGE	\$3.00
CLERK 01	000011 00001

Hard Check

Opening a Hard Check

1. Enter the number of the guest check, press the **CHECK #** key:

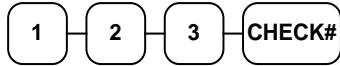

or, press the **CHECK #** key to automatically assign a check:



2. If required, enter the table number and press the **TABLE** key:



3. If required, enter the number of guests and press the **GUEST** key:

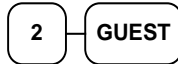

4. Register the items you wish to sell.
5. Place a slip in an optional slip printer, the check will print automatically when you press **SERVICE**:



Adding to a Hard Check

1. Enter the number of the guest check, press the **CHECK #** key:

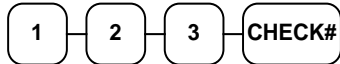

or, if you entered a table number, enter the table number and press the **TABLE** key:



2. Register the next items you wish to sell.
3. To total the posting, press **SERVICE**:



Receipt Example:

THANK-YOU		
CALL AGAIN		
05/01/2019 WED		09:15
CHECK #		# 1 2 3
PBAL		\$0.00
TABLE		#3
GUEST		#2
CHICKEN		\$7.00
STEAK		\$10.00
SERVICE		\$17.00
BFWD		\$17.00
CLERK 01	000011	00001

Receipt Example:

THANK-YOU		
CALL AGAIN		
05/01/2019 WED		10:15
CHECK #		# 1 2 3
PBAL		\$17.00
TABLE		#3
GARLIC BREAD		\$2.00
SERVICE		\$2.00
BFWD		\$19.00
CLERK 01	000011	00001

Paying a Hard Check

1. Enter the number of the guest check, press the **CHECK #** key:

1 — 2 — 3 — CHECK#

or, if you entered a table number, enter the table number and press the **TABLE** key:

3 — TABLE

2. If necessary, add additional items. If you wish to add a tip, press **SUBTOTAL**, then enter the tip amount and press the **TIP** key:

SUB
TOTAL

3 — 0 — 0 — TIP

3. Pay the balance as you would normally tender a transaction, with **CASH**, **CHECK**, or one of the **CHARGE** functions. If the tender is greater than the balance due, change is displayed.

2 — 5 — 0 — 0 — CASH

Sample of Hard Check postings printed on an optional printer:

DATE	07/20/2015	MON
CHECK #		#123
PBAL		\$0.00
CHICKEN		\$7.00
STEAK		\$10.00
SERVICE		\$17.00
BFWD		\$17.00
No.000011	CLERK 01	TIME 09:15
DATE	07/20/2015	MON
PBAL		\$17.00
GARLIC BREAD		\$2.00
SERVICE		\$2.00
BFWD		\$19.00
No.000012	CLERK 01	TIME 10:15
DATE	07/20/2015	MON
PBAL		\$19.00
TIP		\$3.00
CHECKS PAID		\$22.00
TOTAL		\$22.00
CASH		\$25.00
CHANGE		\$3.00
No.000013	LERK 01	TIME 11:15

Fast Food Drive Thru

For fast food drive thru windows, the HK-7200 Series has the capability of storing orders when they are taken, and then recalling the next order automatically at the payment window. (Note: Drive thru storing & recalling must be done at the same register.)

- The **PBAL** function becomes a recall function when the drive thru feature is enabled in the **CHECK #** function key program. Press the **PBAL** key to recall the lowest tracking number balance.
- Orders are stored by first pressing the **CHECK #** key to automatically assign the next tracking number, then pressing **SERVICE**. (A macro sequence key could be created to execute both functions sequentially by pressing the **MACRO** key.)

See “Function Key Programming” in the "Program Mode Programming" chapter.

Taking a Drive Thru Order

1. Register the items you wish to sell.
2. Press the **CHECK #** key to begin an automatically assigned check:

CHECK#

3. To store the posting, press **SERVICE**:

SERVICE

Receipt Example:

THANK-YOU			
CALL AGAIN			
05/01/2019	WED		08:33
HAMBURGER			\$2.00
FRIES			\$1.00
CHECK #			# 3
PBAL			\$0.00
SERVICE			\$3.00
BFWD			\$3.00
CLERK 01		000011	00001

Paying a Drive Thru Order

1. Press the **PBAL** key:

PBAL

2. If necessary, add additional items, register discounts or coupons.
3. Pay the balance as you would normally tender a transaction, with **CASH**, **CHECK**, or one of the **CHARGE** functions. If the tender is greater than the balance due, change is displayed.

5 0 0 CASH

Receipt Example:

THANK-YOU			
CALL AGAIN			
05/01/2019	WED		08:33
CHECK #			# 3
PBAL			\$3.00
CHECKS PAID			\$3.00
TOTAL			\$3.00
CASH			\$5.00
CHANGE			\$2.00
CLERK 01		000011	00001

Clerk Interrupt Operation

Clerk interrupt allows you to temporarily suspend a transaction in progress by allowing a new clerk to sign on and register a new transaction. After the new transaction is complete, the original clerk can sign on, the suspended transaction is recalled and may be completed.

You must use the code entry method for clerk sign on; Program the 'Password' for each employee. See "Employee Programming" in the "Program Mode Programming" chapter.

Set the options: 'Clerk Entry' as 'CODE' and 'Clerk Interrupt' as 'Y'. See "SYSTEM Options" of "Options Programming" in the "Program Mode Programming" chapter.

NOTE: Using the clerk interrupt feature requires allocation of at least one guest check for each clerk and sufficient soft check lines to support the interrupted transaction (i.e. if 20 soft check lines are allocated, a transaction with up to 20 lines can be interrupted.)

To Use Clerk Interrupt System

1. Enter the number of the Clerk and press the **CLERK#** key, or press the **CLERK1,2,3** keys.

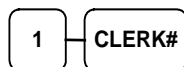

2. Register the items you wish to sell.
3. To total the posting and save for further items.
4. Enter the number of the next Clerk and press the **CLERK#**, or press the **CLERK1,2,3** keys.

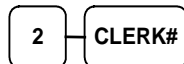

5. Repeat as above until all items have been sold
6. To accept payment press **CASH**, **CHECK** or and other payment function

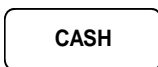

THANK-YOU CALL AGAIN		
05/01/2019 WED	08:33	
PLU1		\$1.00
** CLERK INTERRUPT **		
CASH		\$1.00
CLERK 01	000011	00001

Not Found PLU

Note: The “SYSTEM Options” of “Options Programming” in the "Program Mode Programming" chapter. The option “ENABLE NOT FOUND PLU” must be set to YES to allow this function.

The “Not Found PLU” feature is available for use when an optional scanner is used to input PLU’s. If an item is scanned that is not programmed in the PLU file, the operator has the option to input the price of the item and assign it the same descriptor and properties of another PLU. This provides a simple mechanism for quickly building an item file for a simple scanning installation.

1. Scan an item or input a PLU number. If the item is in the PLU file, it will register, if an item is not in the PLU file, the NOT FOUND PLU screen will display:

```
NOT FOUND PLU
STOP : 0   SAVE : 1
```

2. Press the numeric “1” key to allow the registration of the PLU. The screen will display PRICE field.

```
NOT FOUND PLU
ENTER RICE+CASH
0.00
```

3. Enter the PLU PRICE and press the CASH key. The screen will be display:
4. Not Found PLU

```
NOT FOUND PLU
SELECT COPY PLU
0
```

5. Press a PLU on the keyboard or enter a PLU number and press the PLU key. The PLU will register using the descriptor and tax status of the copied PLU.

Note: The not found PLU will assume the same attributes of the PLU selected here. For example, if the item scanned is a “liquor” item, then press another PLU in the liquor category, or if you are using a PLU designated to accept open liquor entries, that PLU must be set to be a preset PLU with a preset value of zero and preset override allowed.

(If you copy an open price PLU, the not found PLU will also be an open price PLU.)

Not Found PLU List

Managers will typically use the “Not Found PLU list” as a tool to update the PLU file. A list of up to 50 not found PLU items can be retained in the list. When capacity is reached, you must RESET NOT FOUND PLU LIST.

- To print the NOT FOUND PLU list, choose X REPORTS → PLU → NOT FOUND PLU (selection #3) from the PLU REPORT menu.
- To print and clear (reset) the NOT FOUND PLU list, choose RESET NOT FOUND PLU (selection #3) from the Z-MODE menu.

Manager Mode (X Mode)

Introduction

All Management Functions take place with the control lock in the **X** or **Z** position. In this way, only those with the correct key will have access to these operations. Some register operations may be programmed to require the **MANAGER MODE** in order to operate. All reports require a key that will access the **MANAGE MODE (X REPORT)** or **CLOSING MODE (Z REPORT)** position.

Overview

The following procedures can be performed from the Manager Mode (X mode) menu:

- ◆ Manager Mode / Report Mode
- ◆ X Reports
- ◆ Declaration
- ◆ Flash Report
- ◆ Declaration
- ◆ Set Training Mode
- ◆ Program Stock Entry
- ◆ Save Report to SD Card
- ◆ Receipt On or Off

Manager Mode/Report Mode

Manager mode allowed only with manager control can be performed.

1. Move to the “**X**” key lock position to display the **MANAGER MODE** screen:

```
R:ON   CLERK 01           K1 P1
                                     MANAGER MODE
                                     0.00
```

2. Press **CASH** to display the **REPORT MODE**.

```
                                     X MODE
1.X REPORTS                       ←
2.DECLARATION
3.FLASH REPORT
4.SET TRAIN MODE
5.STOCK ENTRY
6.SAVE RPT SD
                                     -PAGE 1/2-
```

```
                                     X MODE
7.RCT ON/OFF                       ←
                                     -PAGE 2/2-
```

X Reports

X reports read sales totals and counters within a report without resetting.

1. Move to the “**X**” key lock position to display the **MANAGER MODE** screen:

```
R:ON  CLERK 01          K1 P1
                                     MANAGER MODE
```

2. Press **CASH** to display the **X MODE** menu.
3. From the **X MODE** menu press **1** and **CASH** to view the X Reports menu:

```
          X REPORTS
1 . FINANCIAL          ←
2 . TIME
3 . PLU
4 . CLERK
5 . GROUP
6 . MIX & MATCH
          - PAGE 1 / 2 -
```

4. Press the **↑** key and the **↓** key to select a report from the menu, press the **CASH** key to confirm. You can also select menu by **page↑** key and **page↓** key.

```
          X REPORTS
7 . STOCK              ←
8 . OPEN TABLE
9 . EJ
          - PAGE 2 / 2 -
```

5. When a report is selected, the options with the report class are displayed. In some cases, further options are displayed. the **FINANCIAL** screen displays.
6. Use the **↑** key and the **↓** key to scroll up and down through the options displayed; Press the **CASH** key to select the option.
7. Select the **REPORT LEVEL (DAILY or PERIOD)** then press **CASH**, the report will start.

```
          FINANCIAL
1 . DAILY (X1)        ←
2 . PERIOD (X2)
          - PAGE 1 / 1 -
```

Electronic Journal Operation

An electronic journal feature is available on the HK-7200 Series. The electronic journal captures the sales journal in the register memory. If you intend to use the electronic journal, you must allocate sufficient memory (see "ALLOCATION" in the "Service Mode Programming" chapter) and activate the journal and set related journal capture options (see "EJ" of "Options Programming" in the "Program Mode Programming" chapter.)

Use this program to print all or selected parts of the journal memory. Note: this program will not clear the electronic journal. See "RESET E.J" in the "Z-MODE".

1. Move to the "X" key lock position; Press **CASH** to display the X MODE menu screen. Press **1** and **CASH** to access the **X REPORTS**.
2. From the **X REPORTS** menu, press **9** and **CASH** to display the electronic journal menu:

```

                                EJ
1 . ALL                               ←
2 . CASH
3 . CHECK
4 . CHARGE
5 . PERCENT
6 . RA / PO
                                - PAGE 1 / 3 -
```

3. Press the ↑ key and the ↓ key to select menu and press the **CASH** key to confirm. You can also select menu by **page** ↑ key and **page** ↓ key.

```

                                EJ
7 . RETURN                               ←
8 . ERR CORR . / VOID
9 . NOSALE
10 . CANCEL
11 . NEGATIVE
12 . RESET REPORT
                                - PAGE - 2 / 3
```

```

                                EJ
13 . VOID MODE                               ←
14 . TRAINING
15 . BY CLERK
16 . BY DATE
17 . BY RCPT NO .
18 . BY LINE
                                - PAGE - 3 / 3
```

Declaration

Cash declaration is the process of counting and reporting media in drawer before a report is taken. "Enforce cash declaration" is an option that requires to the operator to declare amounts of media in the drawer before a financial, clerk, or cash in drawer report can be generated. The purpose of this feature is to insure accurate reporting, even in case of an overage. You can enforce declaration by setting the appropriate options program. See "REPORT" of "Options Programming" in the "*Program Mode Programming*" chapter.

1. Move to the "X" key lock position; Press **CASH** to display the X MODE menu screen.
2. From the **X MODE** menu press **2** and **CASH** to display the **DECLARATION** screen. The cash drawer opens.

DECLARATION	
CASH	0 . 00
CHECK	0 . 00
CHARGE #	0 . 00
TOTAL	0 . 00

3. At the **DECLARATION** screen, enter the amounts for **CASH**, **CHECK**'s, and **CARGE**'s:
 - Enter cash amounts, press the **CASH** key. You can make as many entries as you wish, the screen will keep running totals. You may wish to use the **X/TIME** key to multiply. For example, if you are declaring 37 quarters, you can enter **37**, press **X/TIME**, enter **25**, and then press **CASH**. The result is added to the cash declared running total on the screen.
 - Enter checks individually, or enter a check total, press the **CHECK** key.
 - Enter charges in the drawer, press the appropriate **CHARGE** key.
4. When you have completed declaration entries, press the **CASH** key again to finalize and total your declaration.

Training Mode

A training mode is available so that the register can be operated (to practice registrations) without updating totals and counters. If you choose to use training mode, you must set a training mode password (see "TRAIN MODE" of the "Options Programming" in the "*Program Mode Programming*" chapter.)

- The receipt and journal print the message "TRAINING MODE START" when training mode is activated.
- The receipt and journal print the message "TRAINING MODE END" when training mode is exited.
- The message ** TRAINING MODE ** prints on each receipt printed while training mode is active.
- The journal does not print during training mode.
- The total and counter on the financial report labeled "TRAIN TTL" is updated with the net amount of each training transaction.

Note: If you make registrations to check tracking numbers in training mode, remember that the check tracking total will be updated. Remember to pay or clear the check file (CLOSING MODE menu/Z REPORT/TABLE) before resuming normal operations. You must close all open checks prior to entering training mode.

1. Move to the "X" key lock position; Press **CASH** to display the X MODE menu.
2. From the **X MODE** menu press **4** and **CASH** to enter or exit training mode. The **SET TRAIN MODE** screen displays:

```
SET TRAIN MODE  
  
START: 1 / END: 0
```

3. Enter **1** to start training mode, (if you have selected a training password, type your password when prompted) or enter **0** and press **CASH** to end training mode. A chit will print indicating you are starting or ending training mode.

Stock Entry

If you designate a PLU as an inventory item (see PLU programming) then a special PLU stock counter keeps a running inventory count. This program is where you can set the current stock level or print a scan of current stock quantities. You can choose to Add, Subtract, or Replace the current stock level.

Inventory is kept in decimal units two digits beyond the decimal. you must enter stock adjustments to two digits beyond the decimal. For example, for ten units of inventory type 1 0 0 0 (*without pressing the decimal*).

1. Turn the control lock to the **X** position; Press **CASH** to display the X MODE.
2. From the **X MODE** menu, press **5** and **CASH**; the STOCK ENTRY screen is displayed:

STOCK ENTRY	
1 . PROGRAM	←
2 . SCAN	

ONE PLU

3. To program stock on a single PLU, on the Stock Entry screen, press **1** and then press the **CASH** key. The PROGRAM screen is displayed:
4. From the PROGRAM screen, press **1** and **CASH** to add stock to ONE (*individual*) PLU. The Stock Entry **FROM PLU #** screen displays.
5. Enter the number for the PLU you wish to add stock to, then press **CASH**.
6. Use the ↑ and ↓ keys to select the operation you want to perform: **ADD (+)**, **SUB (-)** or **REPLACE**. When you have the appropriate selection, Press **CASH**.
7. On the **ENTER CNT** screen, enter the stock quantity you wish to ADD/SUB/REPLACE, then press **CASH**. For example: ten units would be entered as 1 0 0 0 (*without pressing the decimal*).
8. You are returned to the Stock Entry screen.
9. Continue entering stock quantities for individual PLUs or press **CLEAR** to exit the screen.

PROGRAM	
1 . ONE	←
2 . RANGE	

STOCK ENTRY	
FROM PLU #	0

STOCK ENTRY	
OPERATOR : ADD (+)	
ADD (+)	←

STOCK ENTRY	
PLU25	
CURRENT	0.00
MINIMUM	0.00
ENTER CNT	0.00

STOCK ENTRY	
ENTER PLU #	0

RANGE PLU

10. To enter stock values for a RANGE of PLUs, From the PROGRAM screen, (See step 3 above) press **2** and **CASH** to display RANGE PLU screen.
11. Enter **FROM PLU#** number to display **TO PLU#** screen. Press **CASH** after each entry.
12. Use the **↑** and **↓** keys to select operation you want to perform: **ADD**, **SUB** or **REPLACE** stock; Press **CASH**.
13. When the **ENTER CNT** displays, enter the stock quantity you wish to **ADD/SUBTRACT/REPLACE**, and press **CASH**. For example: ten units would be entered as 1 0 0 0 (without pressing the decimal).
14. You are returned to the Stock Entry screen.
15. Continue entering stock quantities for PLUs or press **CLEAR** to exit the screen.

```

      STOCK ENTRY
FROM PLU #
                                                    0
    
```

```

      STOCK ENTRY

ENTER FROM PLU#
                                                    1
ENTER TO PLU#
                                                    20
    
```

```

      STOCK ENTRY
OPERATOR : ADD (+)
      ADD (+)
                                                    ←
    
```

```

      STOCK ENTRY
OPERATOR : ADD (+)
      ADD (+)
ENTER CNT
                                                    0.00
    
```

```

      STOCK ENTRY
FROM PLU #
                                                    0
    
```

SCAN STOCK

Current PLU stock values for all inventory PLUs can be printed from the PLU Stock Scan.

1. Turn the control lock to the **X** position; Press **CASH** to display the X MODE.
2. From the **X MODE** menu, press **5** and **CASH**; the STOCK ENTRY screen is displayed:

```

      STOCK ENTRY
1 . PROGRAM
2 . SCAN
    
```

3. Press **2** and **CASH** to print the STOCK SCAN.

Sample PLU STOCK SCAN

```

-----
*****  PLU STOCK SCAN  *****
-----
PLU1
  MINIMUM CNT                0
  STCK CNT                    25
PLU2
  MINIMUM CNT                0
  STCK CNT                    25

CLERK 01                    000006 00000
    
```

Open Table

This operation allows access to the check file (*if used*) that is located in the register. Use this report to print out any open checks stored in the register.

1. Turn the control lock to the **X** position; Press **CASH** to display the X MODE.
2. From the **X MODE** menu, press **8** and **CASH**; the OPEN TABLE screen is displayed:
3. Press **1** and **CASH** to initiate (*print*) the report.

```
STOCK ENTRY
1 . DAILY ( X1 )      ←
- PAGE 1 / 1 -
```

```
10/31/2018  WED    11:29
X1 REPORT                00002
-----
OPEN TABLE
CHECK : 11                $14.41
CLERK 01

CLERK 01    000026    00000
```

Save Report

You can save the Daily (X1) Report files as CSV format or REP format. Please refer to ‘Saving Reports’ in the ‘Program Backup and Restore’ of Service Mode Programming.

Receipt On / Off

You can set the register receipt printer to an *on* or *off* condition. When turned *OFF*, transactions will not be printed, but reports will continue to print, if requested.

1. Press **CASH** to display the X MODE.
2. From the **X MODE** menu, press **7** and **CASH** for stock entry.

```
RCPT ON/OFF
ON:0 / OFF:1
```

3. The **RCPT ON/OFF** screen displays. Press the **0** to print or the **1** to not print.

Note: When the receipt is off, a receipt may be printed after the sale by pressing **CASH** after the transaction is complete.

IRC Report Polling

Using IRC, you can generate consolidated X 1(read) reports(FIN,TIME,PLU,CLERK) from all or select registers in the system.

This report accumulates totals of selected registers (clients) by polling reports with Server register totals. Find the sample Financial Consolidation X1 report below.

See "IRC Setup" in the "Service Mode Programming" chapter.

```

      FINANCIAL
1 . DAILY ( X1 )      ←
2 . PERIOD ( X2 )

      - PAGE 1 / 1 -
  
```

```

      DAILY ( X1 )
1 . STANDALONE      ←
2 . IRC COMM

      - PAGE 1 / 1 -
  
```

Sample Receipt

Report polling in communicated register numbers

```

05/01/2019 WED      13:32
X 1   REPORT      00001
-----
FINANCIAL
CONSOLIDATION
MACHINE NO. 1 3

+PLU TTL                      40
                                $128.76
ADJST TTL                      40
                                $128.73
-----
NONTAX                        $114.76
TAX1 SALES                     $ 14.00
TAX1                           $  1.51
NET SALE                        29
                                $128.76
GROSS SALES                    $128.76
CASH SALES                      26
                                $123.76
CASH-IN-D                      26
                                $123.76
CASH SALES                      26
                                $123.76
CASH-IN-D                      26
                                $123.76
*****
GRAND                        $128.76
  
```

Z-Mode

Overview

All Management Functions take place with the control lock in the X or Z position. In this way, only those with the correct key will have access to these functions.

The following procedures are done from the Z-Mode menu:

- Z Reports
- Reset Electronic Journal
- Reset Not Found PLU List
- Connect Server
- Datatran Function
- Datatran Transaction

Accessing Z-Mode Functions

1. Move the key lock to the **Z** position to display the **Z-MODE** menu:

```
          Z-MODEE
1.Z REPORTS          ←
2.RESET E.J.
3.NOT FOUND PLU
4.CONNECT SERVER
5.DATATRAN FUNCTION
6.DATARTRAN TRANSACTION
          -PAGE 1/1-
```

2. Press the ↑ key and the ↓ key to select menu and press the **CASH** key to confirm. You can also select menu by **page** ↑ key and **page** ↓ key.

Z Reports

Z reports reset sales totals and counters within the selected report.

1. From the **Z-MODE** menu press **1** and **CASH** to select Z Reports:

```
      Z  REPORTS
1 . FINANCIAL      ←
2 . TIME
3 . PLU
4 . CLERK
5 . GROUP
6 . MIX & MATCH
      -PAGE 1 / 2-
```

2. Press the **↑** key and the **↓** key to select menu and press the **CASH** key to confirm. You can also select menu by **page↑** key and **page↓** key.

```
      Z  REPORTS
7 . STOCK          ←
8 . OPEN TABLE
      -PAGE 2 / 2-
```

3. When a report is selected, the **FINANCIAL** screen displays.

```
      FINANCIAL
1 . FINANCIAL      ←
2 . DAY
3 . VOID
4 . TRAIN FINANCIAL
      -PAGE 1 / 1-
```

4. Select the **REPORT LEVEL (DAILY or PERIOD)**. After the selection, the report will start.

```
      FINANCIAL
1 . DAILY ( Z1 )   ←
2 . PERIOD ( Z2 )
      -PAGE 1 / 1-
```

Reset Electronic Journal

An electronic journal feature is available on the HK-7200 Series. The electronic journal captures the sales journal in the register memory. If you intend to use the electronic journal, you must allocate sufficient memory (see "ALLOCATION" in the "Service Mode Programming" chapter) and activate the journal and set related journal capture options (see "EJ" of "Options Programming" in the "Program Mode Programming" chapter.)

Use this to clear the journal memory. The journal will not be printed. To read all or selected parts of the E.J., see "Electronic Journal Operation" in the "Manager Mode (X Mode)" chapter.

1. From the **Z-MODE** menu press **2** and **CASH** to clear the electronic journal:

```
RESET E.J
ARE YOU SURE?
Y=CASH N=CLEAR
```

2. The screen asks: **ARE YOU SURE?** Press the **CASH** key for **YES** or **CLEAR** key for **NO** to clear the report.

Reset Not Found PLU

If a PLU number is input, or scanned, that is not programmed in the PLU file, the operator has the option to input the price of the item and assign it the same descriptor and properties of another PLU. Up to 50 "Not Found" entries can be recorded, when capacity is reached, the memory must be cleared. Use this operation to clear the Not found PLU's.

1. From the **Z-MODE** menu press **3** and **CASH** to clear the Not Found PLU's you added.

```
NOT FOUND PLU
ARE YOU SURE?
Y=CASH N=CLEAR
```

2. The screen asks: **ARE YOU SURE?** Press the **CASH** key for **YES** or **CLEAR** key for **NO** to clear the report.

Open Table

This operation allows access to the check file (*if used*) that is located in the register and clear the tracking file.

1. Turn the control lock to the **Z** position; Press **1** and **CASH** to display the Z REPORTS.
2. Press **8** and **CASH**; the select the OPEN TABLE REPORT. The screen is displayed:
3. Press **1** and **CASH** to initiate (*print*) the report. After printing the check file is cleared.

```
OPEN TABLE
1 . DAILY ( Z1 )
- PAGE 1 / 1 -
```

```
10/31/2018  WED  11:29
Z1 REPORT      00002
-----
OPEN TABLE
CHECK : 11      $14.41
CLERK 01

CLERK 01  000026  00000
```

Service Mode Programming

Introduction

Use the Service Mode (S-Mode) to perform secure operations. The S position is one position clockwise from the PGM position. The S position is not labeled. The key marked with a “C” allows access to this position.

The HK-7200 series provides back-up functions of all reports and PGMs, port device settings, and key assignment. Moreover, you could initialize the memory to factory default and reallocate memory.

Overview

The following procedures are performed from the Service Mode menu:

- Self Tests
- Memory clear
- Allocation
- Assignment of functions to keyboard locations
- Define port
- ECR Setup
- Program backup
- Help menu
- IRC Setup

Accessing Service Mode Functions

1. Move to the **SERVICE MODE** to display the **SERVICE MODE** menu:

```
          SERVICE MODE
1.SELF TEST          ←
2.MEMORY CLEAR
3.ALLOCATION
4.KEY ASSIGN
5.DEFINE PORT
6.ECR SETUP
          -PAGE 1/2-
```

2. Press the ↑ key and the ↓ key to select menu and press the **CASH** key to confirm. You can also select menu by **page** ↑ key and **page** ↓ key.

```
          SERVICE MODE
7.PROGRAM BACKUP    ←
8.HELP MENU
          -PAGE 2/2-
```

Self Test

Various components of the HK-7200 Series are tested by using this program.

1. From **SERVICE MODE** menu press **1** and **CASH** to display the SELF TEST menu:

```
          SELF TEST
1.BATCH TEST
2.PRINTER
3.DISPLAY
4.KEYBOARD
5.INTERFACE
6.RTC
          -PAGE 1/1-
```

2. Press the ↑ key and the ↓ key to select menu and press the **CASH** key to confirm.
3. Press the digit representing the test you wish to perform.

Self-Test Operations

Operation	Selection	Description
1. Batch Test		Runs a series of hardware tests; Some tests require additional equipment or inputs from operator.
2. Printer	1. Print Test	Prints the printer test pattern.
	2. Reverse Image	Prints a test receipt image in reverse.
	3. Endless Print	Prints a test transaction continuously, press clear to exit the test.
	4. Barcode Test	Prints a Test Barcode.
	5. Make Barcode	Print a barcode for numeric entry up to 13 digits.
3. Display	1. LCD Test	Runs the LCD Tests.
	2. Contrast Test	Performs the Contrast Test.
4. Keyboard	1. Keyboard Test	Allows keyboard test – press desired keys to test.
	2. Mode Key Test	Mode test – tune mode key to VOID and back to S-Mode.
5. Interface	1. Port 1	Port tests require a Loop-Back connector be attached to the port for testing.
	2. Port 2	
	3. Drawer	Press CASH to Kick the drawer, close the drawer to repeat test; press CLEAR to exit the test.
	4. USB Host	Insert USB drive to run test.
	5. External SD	Insert SD Card to run test.
	6. Micro SD	Insert Micro SD to run test.
	7. Ethernet	Requires Ethernet connection to run test.
6. RTC	1. RTC Set	Set Date & Time
	2. RTC View	View the Date & Time

Memory Clear

Before you use your HK-7200 Series for the first time, you **must** perform a memory all clear to ensure that all totals and counters are cleared and that the default program is installed. Go to “*Clearing Memory*” on page “26” to complete this procedure.

From the Service Mode menu, you can clear selected areas of memory without clearing memory entirely.

1. From **SERVICE MODE** menu press **2** and **CASH** to display the MEMORY CLEAR screen:
2. Press the **↑** key and the **↓** key to select menu and press the **CASH** key to confirm. You can also select menu by **page ↑** key and **page ↓** key.

```
MEMORY CLEAR
1 . CLEAR TOTAL      ←
2 . CLEAR GRAND
3 . CLEAR PLU
4 . CLEAR PRICE=0
5 . EDIT COUNTERS
6 . NON MOVER CLR
```

3. Press the **↑** key and the **↓** key to select menu and press the **CASH** key to confirm. You can also select menu by **page ↑** key and **page ↓** key.
4. To clear total, press **1** the **CASH**. The screen asks: ARE YOU SURE?

```
ARE YOU SURE?
Y=CASH N=CLR
```

5. Press the **CASH** for YES or the **CLR** for NO.
6. The message "ALL TOTAL CLEAR" is printed and the screen returns to the SERVICE MODE menu.

Clear Totals

This selection clears all totals and counters, including the grand total.

Clear Grand Total

This selection clears only the grand total.

Clear PLU File

This selection clears the entire PLU file, including totals, counters and programming.

Clear Price=0

This selection clears the entire PLU's programmed zero price.

Edit Counters

This selection edits some counters and totals:

Press CASH to edit the Z counter,

Press CASH to edit the Receipt No,

Press CASH to edit the Grand Total and

Press CASH to edit the Train Grand Total.

Press CASH again to exit.

EDIT COUNTERS	
Z COUNTER	1
RECEIPT #	13
GRAND TOTAL	
	100.00
TRAIN GRAND TTL	
	0.00

Clear Non Mover

This selection clears the entire PLU file for items that have not sold, including totals, counters and programming.

Memory Allocation

Note: You must step through every memory allocation field to implement new memory allocation. If you press CLEAR, at any field you will abort memory allocation processes without making changes. Changes to Memory Allocation will clear all program data.

1. From **SERVICE MODE** menu press **3** and **CASH** to display the MEMORY CLEAR screen:
2. Press the \uparrow key and the \downarrow key to select menu and press the CASH key to confirm. You can also select menu by **page** \uparrow key and **page** \downarrow key.

```

ALLOCATION
PLU #
( 60-8000 )
1000

BYTES REMAINING 64747 BYTES
  
```

3. Starting at the PLU's field, enter the quantity of each memory field. Press the **CASH** key after each entry, and the screen will move to the next field.

```

ALLOCATION

ARE YOU SURE?
Y=CASH N=CLEAR
  
```

4. Continue filling each field until completion. Press **CASH** after setting the last field, "CHECK TYPE". The screen will display "ARE YOU SURE ?". Press the **CASH** for YES or the **CLEAR** for No.
5. The message will print either: "MEMORY ALLOCATION OK" or "MEMORY ALLOCATION SIZE OVER" if you attempt to allocate features requiring more memory than is available.

DEFAULT Memory Allocation Specifications

ALLOCATION ITEM	DEFAULT	MAXIMUM
PLU	1000	3200
CLERK	10	99
GROUP	10	99
PRICE LEVEL	1	2
MIX AND MATCH	20	100
EJ LINE	1000	15000
CHECK#	10	500
SOFT CHECK LINES	50	100
CHECK TYPE	0	SOFT(0) / HARD(1)

Function Key Assignment

Any programmable key location may be reprogrammed with a function from the list of available functions on page 98 of this manual. The default program installs the functions as they are shown with the standard key legends.

To change the function key assigned on a specific key:

1. At the **SERVICE MODE**, press **4** and **CASH** for Key Assignment programming. The **KEY ASSIGNMENT** screen displays:

```
KEY ASSIGN                                000
[ HELP ]
■ENTER FUNCTION KEY CODE
■PRESS FUNCTION KEY TO SAVE
■REPEAT OR [CASH] TO END
■[ SUBT ] : CODES      [ CASH ] : END
```

2. Enter a new key code from “*Function key codes*” on page “98” and press key location.

You can Press the SUBTOTAL key to print the key code table.

3. Press **CASH** to save the changes you have made and to return to **SERVICE MODE**.
4. The printer will print out a receipt showing all the changes made to the keyboard.

Notes:

- **Numeric keys (0-9), CLEAR, and CASH** cannot be removed from the keyboard unless they have been assigned to a new keyboard location. This protects the programmer from accidentally removing keys that are required for register programming and operations.
 - **CHARGE** ↑ and **CHECK** ↓ keys are used for navigation throughout the X – Z – P and S-Mode operations. These key locations revert to their navigation operations, ↑ and ↓ when used in the X – Z – P and S-Modes.
 - If you wish to program the **CASH** key, select it immediately after selecting **KEY ASSIGNMENT** from the **SERVICE MODE** menu. After the initial key is programmed, the **CASH** key is used to finalize the program.
-

Function Key Codes

Code	Function
001~300	NLU 1~NLU 300
301~309	Numeric 1~9
311	DOUBLE ZERO
312	DECIMAL
310	ZERO
313	#/NS
314	% 1
315	% 2
316	% 3
317	% 4
318	% 5
319	X/TIME (PRT SCREEN)
320	ADD CHECK
321	CANCEL
322	CASH
323	CHARGE 1
324	CHARGE 2
325	CHARGE 3
326	CHARGE 4
327	CHARGE 5
328	CHARGE 6
329	CHARGE 7
330	CHARGE 8
331	CHECK
332	CHECK CASH
333	ENDORSEMENT
334	CLEAR
335	CLERK#
336	CONV. 1
337	CONV. 2
338	CONV. 3
339	CONV. 4
340	ERR CORRECT
341	F/S SHIFT
342	F/S SUBTOTAL
343	F/S TEND
344	PLU #

345	PRICE LEVEL 1
346	PRICE LEVEL 2
347~356	MACRO1 ~ MACRO10
357	MDSE RETURN
358	MODIFIER 1
359	MODIFIER 2
360	MODIFIER 3
361	MODIFIER 4
362	MODIFIER 5
364	PO 1
365	PO 2
366	PO 3
367	PAPER FEED
368	PROMO
369	RA 1
370	RA 2
371	RA 3
372	SUBTOTAL
373	SCALE
374	TARE
375	TAX EXEMPT
376	TAX SHIFT 1
377	TAX SHIFT 2
378	TAX SHIFT 3
379	TAX SHIFT 4
380	VOID ITEM
381	WASTE
382	VALIDATION
383	PRICE INQUIRY
384	RECEIPT ON/OFF
386	ALPHA TEXT
387	AUTO CASH 1
388	AUTO CASH 2
389	AUTO CASH 3
390	AUTO CASH 4
391	AUTO CASH 5
392	AUTO CASH 6
393	AUTO CASH 7

394	AUTO CASH 8
395	AUTO CASH 9
396	CLERK 1
397	CLERK 2
398	CLERK 3
399	CLERK 4
400	CLERK 5
401	CLERK 6
402	CLERK 7
403	CLERK 8
404	CLERK 9
405	CLERK 10
406	CHARGE #
407	HELP
408	MACRO #
409	PRICE CHANGE
410	STOCK INQUIRY
411	KEY SHIFT 1
412	KEY SHIFT 2
413	KEY SHIFT 3
414~415	RESERVED
416	EMV TIP
417~443	RESERVED
444	EAT IN
445	TAKE OUT
446	DRIVE THRU
447	CHECK #
448	GUEST #
449	PBAL
450	PRINTCHECK
451	SERVICE
452	TABLE #
453	TIP
454	CHECK SPLIT
455~457	Reserved
458	INACTIVE

Define Port

Connection to optional POS devices is provided with one DB9 and two RJ45 standard RS-232C serial ports and one USB port. The port option settings here assign the device and communication protocol for each port.

Serial Port Setting

1. At the **SERVICE MODE**, press **5** and **CASH** for RS232C programming. The port selection screen displays:

```
                DEFINE PORT
1. PORT 1
2. PORT 2
3. USB TYPE
4. SCAN

                - PAGE 1 / 1 -
```

2. Enter the digit (1-5) corresponding to the port you wish to program. Press the **5** and **CASH** to print the settings for ports 1-3. The **appropriate PORT PROGRAM** screen displays:
3. Press the **↑** key and the **↓** key for selecting value. Press **CASH** to confirm the option value and return menu. You can also select menu by **page ↑** key and **page ↓** key.

```
                PORT 1
1. BAUD RATE           [ 9600 ]
2. PARITY              [ NONE ]
3. DATA BITS         [ 8BITS ]
4. STOP BITS          [ 1BIT ]
5. DEVICE             [ NONE ]
6. PRINTER            [ NONE ]
```

```
                PORT 1
7. DISPLAY            [ EPSON ]
8. SCALE              [ NCI ]
9. KP START LINE     [ 0 ]
10. KP END LINE      [ 7 ]
11. SLIP START LINE  [ 0 ]
```

4. Press the **CLEAR** key to finalize and return to the DEFINE PORT screen.

RS232C Settings Screen Program Notes

Option	Description
BAUD RATE	Select 1200, 2400, 4800, 9600, 19200, 38,400, 57,600, or 115,200 from the screen. (9600 is default.)
PARITY	Select NONE, EVEN or ODD. (NONE is default.)
DATA BITS	Select 8 or 7 from the screen. (8 is default.)
STOP BITS	Select 1 or 2 from the screen. (1 is default.)
DEVICE FUNCTION	Select NONE, PC, PRINTER, *SCANNER, POLE, SCALE, EFT, DATATRAN or REMOTE JOURNAL from the screen. (NONE is default.)
PRINTER TYPE	Select the printer type connected to this port.
DISPLAY	Select the pole display type connected to this port.
SCALE	Select the scale type connected to this port.
KP START LINE (0-20)	Enter the number of KP START LINE.
KP END LINE (0-20)	Enter the number of KP END LINE.
SLIP START LINE (0-20)	Enter the number of SLIP START LINE.

*The register will work with lower power USB scanners, but not the Metrologic/Honeywell. The Metrologic/Honeywell scanners can be used with the serial connection, they will require the DB9 to RJ45 adaptor and the power supply.

USB Setting

1. At the **SERVICE MODE**, press **5** and **CASH** for DEFINE PORT.
2. From the DEFINE PORT screen, press **3** and **CASH** for USB TYPE.
3. Press the ↑ key and the ↓ key to select USB type and press the CASH key to confirm

USB TYPE	
DEVICE :	MEMORY
MEMORY	

Note: If you select other types, Your HK-7200 series will be rebooted by itself.

USB Specifications

USB TYPE		USB VERSION	SPEED
PC-COM	For connecting PC	-	-
SCANNER	For using USB scanner	USB 2.0 (only HID type)	FULL SPEED only
MEMORY	For backup & restore	USB 2.0	FULL SPEED

ECR Setup

1. From **SERVICE MODE**, press **6** and **CASH** for ECR SETUP screen displays:

```
          ECR SETUP
1.ROM INFO
2.PRINT DENSITY
3.LCD CONTRAST
4.SET NETWORK
```

2. Press the **↑** key and the **↓** key for selecting value. Press **CASH** to confirm the option value and return menu.

ROM INFO

This selection displays the version information, check sum and date of the Flash ROM. You may be asked to check your Flash ROM version if you contact your dealer for assistance.

1. From **ECR SETUP** menu, press **1** and **CASH** key for ROM INFO.
2. The version information is printed, press **CLEAR** key to returns to the **SERVICE MODE** menu.

Print Density

1. From **ECR SETUP** menu, press **2** and **CASH** to program 'PRINT DENSITY' screen:

```
          PRINT DENSITY
(DENSITY LEVEL:1-3)      2
```

2. Press the **↑** key and the **↓** key for selecting value. Press **CASH** to confirm the density level and return to the ECR SETUP menu.

LCD Contrast for 16-Character LCD

1. From **ECR SETUP** menu, press **3** and **CASH** to program 'LCD CONSTRAST' screen:
2. Press **1** and **CASH** key for Customer Rear Display (Two Line).
3. During check Customer Rear Display press the **↑** key and the **↓** key to change contrast. Press **CASH** to confirm and return to the ECR SETUP menu.

LCD Contrast for Graphic LCD

1. From **ECR SETUP** menu, press **3** and **CASH** to program 'LCD CONSTRAST' screen:
2. Press **2** and **CASH** key for Operator Display (Multi Line).
3. During check Operator Display press the **↑** key and the **↓** key to change contrast. Press **CASH** to confirm and return to the ECR SETUP menu.

Set Network

Use DHCP, ECR IP, ECR SUBNET, ECR GATEWAY, Server IP, Server PORT, ETHERNET USE.

Read Carefully: Store Name Notes

The store name you set on “Store name” in the “SYSTEM Options” is used to identify program and report data on the SD card. Note that the default store name is “STORE001”. When changing the Store Name, always use an 8-character store name.

If you are using the SD Card to move information to a PC or use the program or report data with the PC Utility, you must pay close attention to the store name. Do not use characters such as “-” or “/” that cannot be used in naming a folder on your PC. If you use such a character in your store name, you will not be able to read the files on your PC.

The Store Name field is 8-characters in length.

Note: If you are Using an SD Card for the First Time . . .

NOTE: SD cards must be formatted as FAT 32

NOTE: The SD card supports more than 1GB.

CAUTION: Formatting the SD card will clear all data on the SD card and prepare it for use.

1. Start Windows Explorer.
2. Select the SD card drive, right click and select **Format**. (Win XP screen shown; slightly different procedures are used with different operating systems.)
3. From the **Format** dialog you must select the **File System: FAT32**.

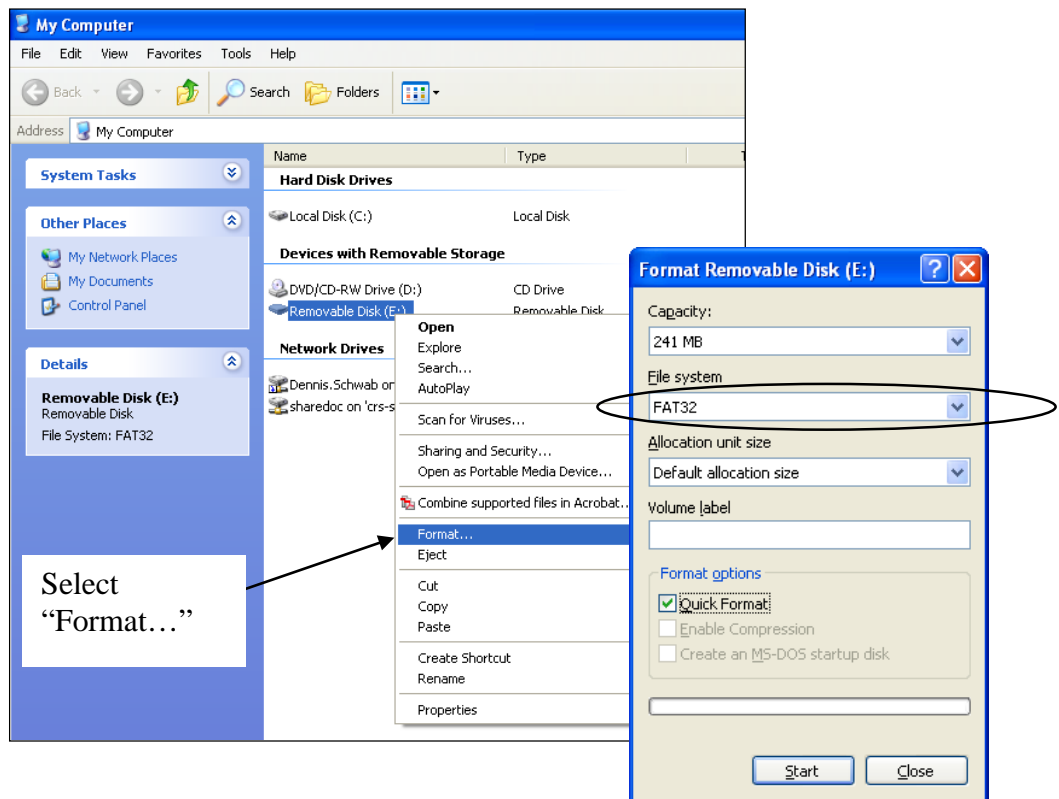

Program Backup and Restore

Use this operation to back up and load (restore) program files, image files or save report data using an SD or USB memory device.

USB and SD Utilities in this program include:

- Program Backup & Restore
- Report Save
- Image Save & Load
- Boot Up SD (Available on SD Only)
- Boot Up COM (Available on SD Only)

Additionally, Flash ROM updates can also be performed by SD card or through a serial connection to a connected PC.

-
- **The SD Card port is located in the printer compartment. Remove the security screw to access the SD port. See “Inserting External SD Card” on page 13 for detail.**
 - **The USB port is located on the connection panel on the back of the ECR. The USB port must be assigned the “Memory” function to be used for backup utilities. See USB Setting” on page 100.**
-

Program Backup

It is a good practice to make note of the memory allocation settings when backing up a program file so that it can be re-entered before restoring the program.

1. Set the store name at *System Option #39* to the name of the store you want to create on your memory device.
2. Insert an SD card in the register’s SD slot (*located in the printer compartment*) or connect a USB drive on the USB port (*located on the back, connection panel*).
3. Move keylock to the **SERVICE MODE**.
4. From the Service Mode menu, select “**7.PROGRAM BACKUP**”. Press **CASH**.
5. The **PROGRAM BACKUP** menu displays:

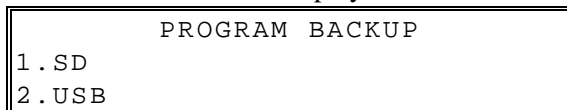

6. From the PROGRAM BACKUP menu select “**1.SD**” or **2.USB**.”
7. From the USB or SD menu select “**1.PGM BACKUP**”.
 - a. The HK-7200 Series will write the program files to the folder:
HK-7200\STORENAME\PGMBACK
 - b. In the example below, the store name is “HK-SYSTEMS”.
8. After a short pause, the register will display confirmation of the successful backup with the message “SUCCESS !”. Below is an Explorer view of the backed-up files.

Example Program Backup File CHANGE

The HK-7200 will write the backed-up program files to the selected removeable memory device to the folder: HK -7200\STORENAME\PGMBACK

Below is a File Explorer view of the backed-up files. In the example below, the store name is “HK-SYSTEMS”.

Note: The default store name is “STORE001”. You can edit this store name as desired. See System Options programming on page 156 for more information about the store name.

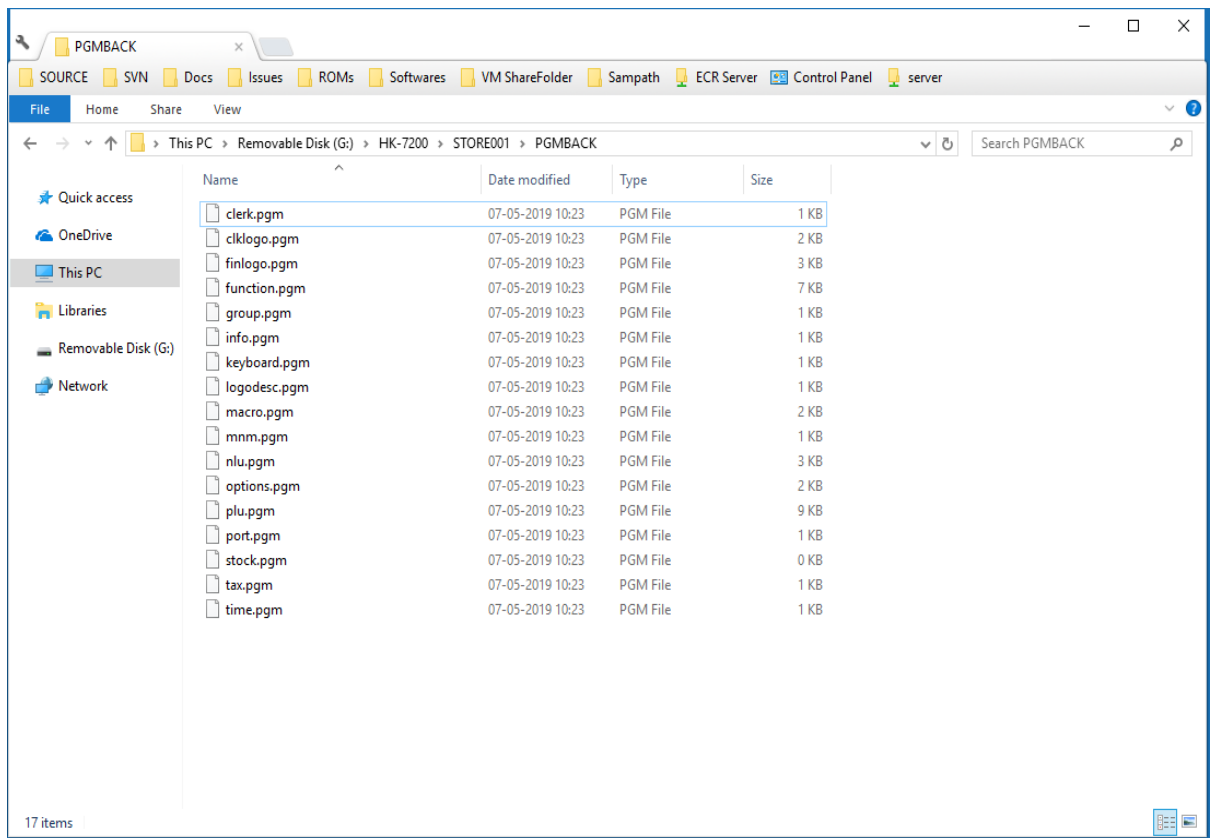

Restore Program

Set the store name on the HK-7200 in System Options programming, option #39, to match the name of the store folder you wish to restore.

CAUTION: Memory allocation must be set the same as the saved program.

1. Set the store name in System Option, option #39, to match the name of the store folder on your memory device you wish to restore.
2. Insert an SD card in the register's SD slot (*located in the printer compartment*) or connect a USB drive on the USB port (*located on the back, connection panel*).
3. Move key lock to the **SERVICE MODE**.
4. From the Service Mode menu, select "**7.PROGRAM BACKUP**". Press **CASH**.
5. The "PROGRAM BACKUP" menu displays:

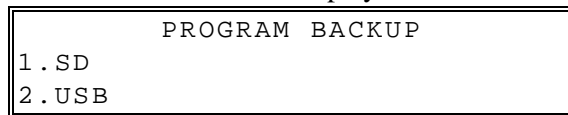

6. From the PROGRAM BACKUP menu select "**1.SD**" or "**2.USB**". Press **CASH**.
7. From the USB or SD menu select "**2.PGM RESTORE**".
8. The register will display confirmation of the successful restoration with the message "SUCCESS !". If the restore is unsuccessful, the register will print a "FAIL !" error message.

Saving Reports

You can choose to save the current X1 report data from the HK-7200 to a USB or SD memory device. Reports can be saved as 'CSV' (*spreadsheet format*) or 'REPORT' format (*to view with the eSpesso PC utility*).

Report Backup Notes

- When backing up and restoring data, the store name must be programmed in the "SYSTEM Options" of "Options Programming". The default store name is: "STORE001".
- The HK-7200 Series will write the program files to folder. For example:
HK-7200/STORENAME/SALEBACK/CSVBACK/DATE/TIME
- or - HK-7200/STORENAME/SALEBACK/REPBACK/DATE/TIME
- The date folder depends on date format option. See "SYSTEM Options" of "Options Programming" in the "*Program Mode Programming*" chapter to set DATE FORMAT.

<u>DATE FORMAT</u>	<u>DATE FOLDER NAME</u>
YYMMDD	20140403
DDMMYY	03042014
MMDDYY	04032014

- Each individual report is named with the time the report was taken. For example, "CLK02332" represents a Clerk report taken at 23:32 (in a 24-hour time format.) In this manner, multiple reports backed up at different times in the same day will collect in the same "date" folder.

To Save Reports

1. Set the store name in System Option, option #39, to match the name of the store folder on your memory device you wish to restore.
2. Insert an SD card in the register's SD slot (*located in the printer compartment*) or connect a USB drive on the USB port (*located on the back connection panel*).
3. Move to the **SERVICE MODE**.
4. From the Service Mode menu, select "**7.PROGRAM BACKUP**"; Press **CASH**.
5. From the PROGRAM BACKUP menu select "**1.SD**" or "**2.USB**"; Press **CASH**.
6. From the SD or USB menu select "**3.REPORT SAVE**"; Press **CASH**.
7. Select type **1.CSV FORMAT** (Spreadsheet format) or **2.REP FORMAT** (for HK-SYSTEMS eSpreso PC Utility format); Press **CASH**.
8. The register will display confirmation of the successful restoration with the message "SUCCESS !". If the save is unsuccessful, the register will print an error message.

Saved Report Examples

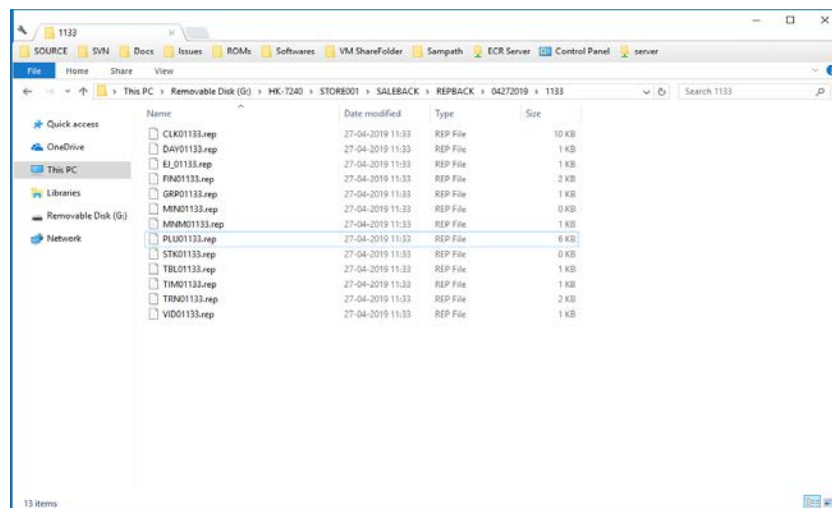
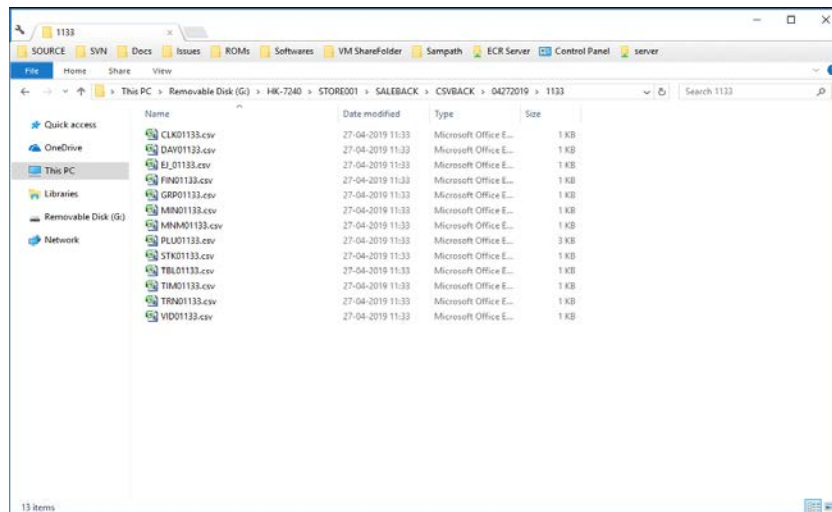

Load/Save Receipt Images

You can load a preamble and postamble image on your receipt or soft guest check. Before loading, the images must be converted by the HK-SYSTEMS PC Utility to .img format. After conversion, they can be loaded directly by connecting a PC to the HK-7200 Series or by copying the images to a SD card and loading (or saving the image) using the SD utility program described here.

Note: After loading the images to the register, you must set the “LOGO Option” (Print preamble image / Print postamble image) of the “Options Programming” in the “Program Mode Programming” to activate the image printing.

Use the HK-SYSTEMS PC Utility(eSpresso) to Convert the Image

1. Install the *eSpresso* on your PC and run it.
2. If you start the *eSpresso* for the first time, you must define the store and register, or if the store and register is already defined, you can select the store from the register list. The *eSpresso* program starts.
3. At the *eSpresso*, choose Image Logo from the Edit Program menu.
4. Click the FILE OPEN (📁) button. Select the image file that you wish to use from the Open dialog and click the Open command button.
5. You can view the original and the converted image of a selected image.
6. You can change the properties of the image. (Sharpness and Brightness)
7. You can select the PREAMBLE IMAGE or POSTAMBLE IMAGE.

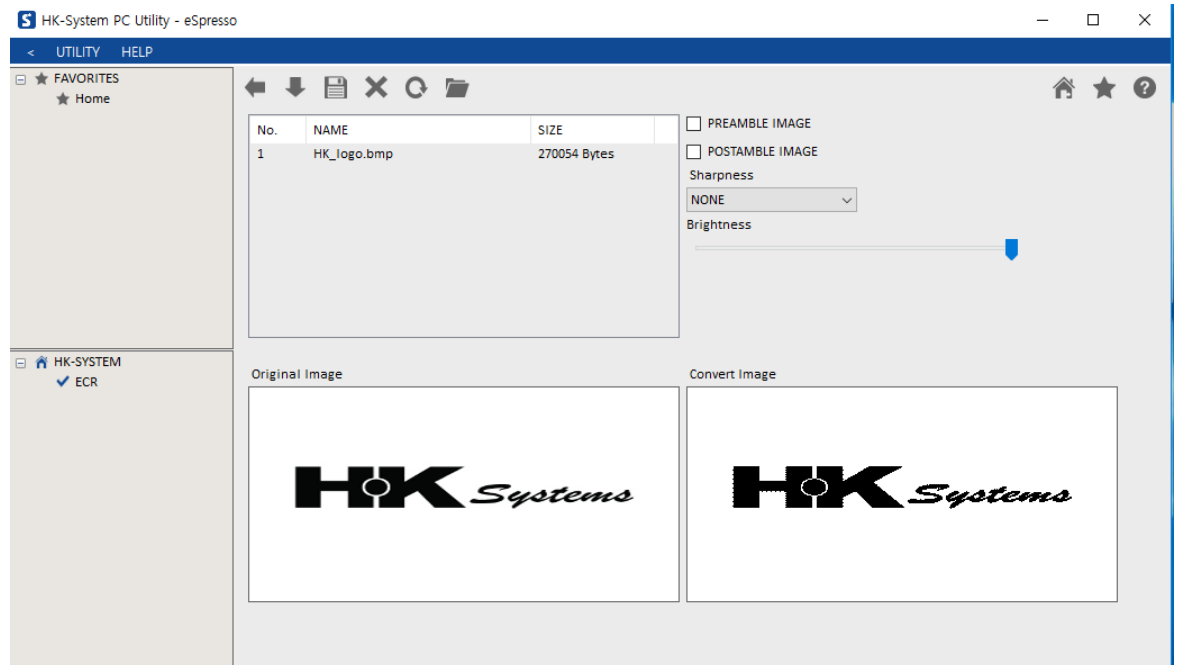

8. Click the DOWN (↓) button. “Download completed” message is displayed.
 - ※ If you want to save the converted image, Click the SAVE (💾) button. (Saved images are stored in My Documents folder.)

Copy the Images to an SD Card

The PC Utility will create two image files:

- USERPRE.IMG
- USERPOST.IMG

They will be located in your PC at:

C:\Users\[Computer name]\Documents\eSpresso\[Store name]\[Register name]

Copy the images to the following path on your SD card:

SD\HK-7200\[Storename]\IMAGE

Important: In the path: C:\Users\[Computer name]\Documents\eSpresso\[Store name]\[Register name], the store name and register name are the names you have defined as the store in the HK-SYSTEMS PC Utility.

Note: You must use the same store name in the HK-7200 Series ECR at “Store name” of “SYSTEM Options, option #39” of the “Options Programming” in the “*Program Mode Programming*”.

Also Note that the default store name is “STORE001”. When changing the Store Name, always use an 8-character store name.

Saving Images

1. Set the store name in System Option, option #39, to match the name of the store folder on your memory device you wish to restore.
2. Insert an SD card in the register’s SD slot (*located in the printer compartment*) or connect a USB drive on the USB port (*located on the back connection panel*).
3. Move to the **SERVICE MODE**.
4. From the Service Mode menu, select “**7.PROGRAM BACKUP**”; Press **CASH**.
5. From the PROGRAM BACKUP menu select “**1.SD**” or “**2.USB**”; Press **CASH**.
6. From the USB or SD menu select “**4.IMAGE SAVE**”; Press **CASH**.
7. The message “SUCCESS !” will display on the LCD.

Loading Images

1. Insert an SD card in the register’s SD slot (*located in the printer compartment*) or connect a USB drive on the USB port (*located on the back connection panel*).
2. Move to the **SERVICE MODE**.
3. From the Service Mode menu, select “**7.PROGRAM BACKUP**”; Press **CASH**.
4. From the PROGRAM BACKUP menu select “**1.SD**” or “**2.USB**”; Press **CASH**.
5. From the SD menu select “**5.IMAGE LOAD**”; Press **CASH**.
6. The message “SUCCESS !” will display on the LCD.

Flash ROM Updates

The HK-7200 Series register software is loaded in flash ROM. This program may occasionally be updated by the manufacturer. Your HK-SYSTEMS dealer can update the software if necessary. The Flash ROM can be loaded through a PC or by SD card.

CAUTION: Flash ROM update by either method must be done by a qualified, trained technician. DO NOT POWER OFF OR ABORT any program loading once it has started. Failure to follow the procedures exactly may cause the program to load incompletely and for the register to fail completely.

Flash ROM Update by SD

The HK-7200 Series Flash ROM program is contained in a binary file. This file contains both the Boot program area and the Application program area.

1. Copy binary file to the update folder of the SD card: SD:/update/NR_ROM.bin
2. Insert the SD card into the register. (The SD slot is located inside the printer compartment. Remove the security screw and open the flap securing the SD slot. Insert the SD card until you hear a click sound and the SD card is locked in.)

Boot Area Update

3. At the HK-7200 Series, move to the **SERVICE MODE**.
4. Press the **↑** key and the **↓** key to select menu and press the **CASH** key to confirm. Select the **7.PROGRAM BACKUP** menu. Then select **“1.SD”**.
5. Select the **6.BOOT UP SD** menu.
6. After a short pause, the register will display confirmation of the successful download with the message **“DOWNLOAD 100 % FINISHED! !**.
7. Turn the ECR power switch **OFF/ON** and proceed directly to the next step: Application Update.

Program Area Update

8. Set the **SERVICE MODE**.
9. Press the **upper right** key and the **lower right** key. A rapid beep-beep-beep sound will be heard. Release the upper right key and the lower right key.
10. Press the **↑** key and the **↓** key to select menu and press the **CASH** key to confirm. Select the **2.SD** menu.
11. The display will flash (Current program is being erased) after a few seconds, the display will continue to flash, but at a slower rate. This continues for about 1-minute while the new program is being loaded. When the load is complete, a rapid beep-beep-beep sound will be heard again the display will stop flashing and display a blue color to confirm update completion.
12. Power the register **OFF**. The FLASH ROM update is complete.
13. Remove the SD card from the register.

14. Perform a **memory all clear** on the ECR (See ‘Clearing Memory’ procedure on page 26). The ECR is now ready to program or to load a previously saved end-user program.

Flash ROM Update by PC

To complete the firmware update via PC, you will need a serial PC cable, the Flash ROM update file and the utility to load the file.

Update Files

To complete the firmware update, you will be supplied with the following files:

- DownLoad.exe (The update utility program)
- Binary file

PC Connection Cable

YOU MUST USE Port #1. Use the following cable:

- Register DB-9MF COM 1 to PC DB-9F

Boot Area Update

1. Connect the Serial Cable from ECR to PC.
2. At the register, move to the **SERVICE MODE**.
3. Press the ↓ key and the ↑ key to select “**7.PROGRAM BACKUP**” menu; Press **CASH**.
4. Then select “**1.SD**”; Press **CASH**.
5. Select the **7.BOOT UP COM** menu; Press **CASH**.
6. At the PC, execute the program “DownLoad.exe”. The Download dialog box displays.

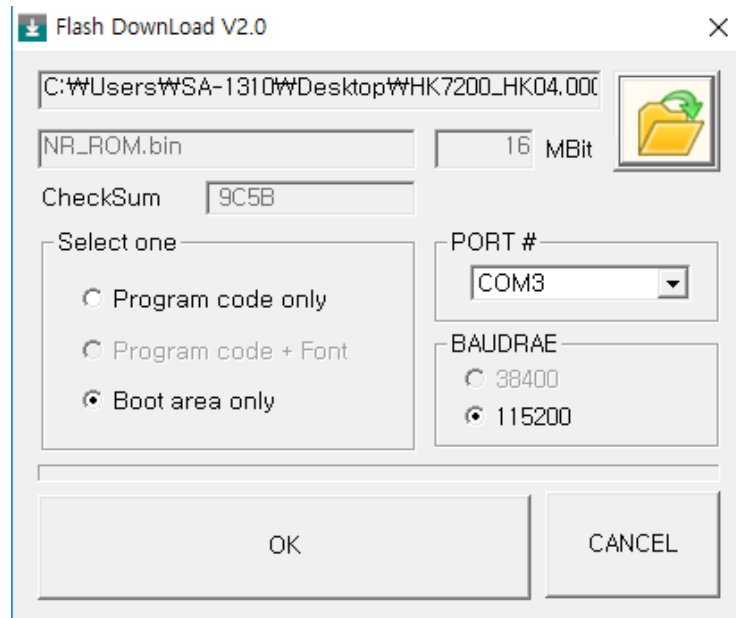

7. Select the appropriate com port connection at your PC at the PORT# option buttons.
8. Click  find the folder where the update files are located and select binary file.

9. Select **Boot Area Only** in the Select One option buttons.
10. Press **OK** Button. The download takes about 30 seconds; the scroll bar will track the progress of the download. At the ECR, the display will flash slowly while the update is taking place.
11. When complete, the message **Completed** displays on the PC. Click **OK** and the Download program will close. At the ECR, the display will change to a blue color indicating the update is complete. Turn the power switch to the **OFF**.

Program Area Update

1. Connect the Serial Cable from ECR to PC.
2. At the register, move to the **SERVICE MODE**.
3. Turn the power switch to the **OFF** position.
4. Press the upper right key and the lower right key. A rapid beep-beep-beep sound will be heard. Release the upper right key and the lower right key.
5. Press the \uparrow key and the \downarrow key to select menu and press the **CASH** key to confirm. Select the **1.SERIAL1** menu.
6. At the PC, execute the program "Download.exe". The Download dialog box displays.
7. Select the appropriate com port connection at your PC at the PORT# option buttons.
8. Click  find the folder where the update files are located and select binary file.
9. Select **Program code only** in the Select One option buttons.
10. Press **OK** Button. The download takes about 3 minutes. At the PC, the scroll bar will track the progress of the download. At the ECR, the display will flash (Current program is being erased), after a few seconds, the display will continue to flash, but at a slower rate. This continues for about 3 minutes while the new program is being loaded.
11. When complete, the message **Completed** displays at the PC. Click **OK** and the Download program will close. At the ECR, when the load is complete, a rapid beep-beep-beep will be heard, and the display will flash rapidly. Turn the power switch to **OFF**, the program update is complete.
12. Disconnect the PC cable.
13. Perform a **memory all clear** on the ECR (See 'Clearing Memory' procedure on page 26). The ECR is now ready to program or to load a previously saved end-user program.

Help Menu

The help menu prints out Menu Operation keys (*function keys used for program navigation*). The Function key list and the character code table can also be printed from this menu.

Menu Usage

1. Move the key lock to the **SERVICE MODE**.
2. From the Service Mode menu, select “**8.HELP MENU**”; Press **CASH**.
3. From the Help Menu, select “**1.MENU USAGE**”; Press **CASH**.
4. The “MENU OPERATION” list prints
CLEAR : EXIT OR CANCEL
↑ : CURSOR UP MENU OR
SELECT 'YES'
↓ : CURSOR DOWN MENU OR
SELCT 'NO'
CASH : CONFIRM

Function Key Code

1. Move the key lock to the **SERVICE MODE**.
2. From the Service Mode menu, select “**8.HELP MENU**”; Press **CASH**.
3. From the Help Menu, select “**2.FUNC. KEY CODE**”; Press **CASH**.
4. The complete “FUNCTION KEY CODE” list prints.

Character Code

1. Move the key lock to the **SERVICE MODE**.
2. From the Service Mode menu, select “**8.HELP MENU**”; Press **CASH**.
3. From the Help Menu, select “**3.CHAR CODE**”; Press **CASH**.
4. The complete “CHAR. CODE TABLE” list prints.

IRC Setup

When multiple registers are connected in an IRC network, you can download programs from one register to any or all of the remaining registers.

1. From **SERVICE MODE**, press **9** and **CASH** for IRC SETUP screen displays:

```
          IRC SETUP
1. REG# (1-8)
2. IRC SERVER
3. IRC CLIENT
4. IRC SELECT
```

2. Press the **↑** key and the **↓** key for selecting value. Press **CASH** to confirm the option value and return menu.

REG# (1-8)

Enter the sequential number of the register in the IRC System.

```
          REG# (1-8)
IRC NUMBER                                     1
```

IRC SERVER

Choose 'Y' in Menu to select register as Server to download programs and poll reports on Client register

```
          IRC SERVER
IRC SERVER                                     Y OR N
SELECT : UP, DOWN
CHNAGE : CASH
CANCEL : CLEAR
```

IRC CLIENT

Choose 'Y' in Menu to select register as Client

IRC CLIENT	
IRC CLIENT	Y OR N
SELECT : UP,DOWN	
CHNAGE : CASH	
CANCEL : CLEAR	

IRC SELECT

Choose 'Y' to select Client register numbers for communication with Server

IRC SELECT							
1	2	3	4	5	6	7	8
N	N	N	N	N	N	N	N
SELECT : UP,DOWN							
CHNAGE : CASH							

Program Mode Programming

Overview

Most register programming takes place in program mode (the control lock is placed in the PGM position.) Programs here include:

- **PLU** – Set PLU prices, descriptors and options. Also, assign PLU's to groups, link to other PLU's, assign to mix and match groups, set stock levels and set additional options
- **Group** – Groups collect sales from sets of items (PLU's) Set descriptors and options for groups here.
- **Function Key** – Set descriptors, entry limits and specific options related to each function key you may be using.
- **Options** – Set options related to the operation of your register.
- **Employee (Clerk)** – Set names, codes and assignments for each clerk.
- **Time** – Set the register date and time.
- **Taxes** – Set tax rates or tables can be set for each of four possible taxes. Value added taxes and GST (Canada) can be set.
- **Messages** – Set receipt messages and report descriptors
- **Mix & Match** – Set up discounts such as “buy 2 and get \$1 off”.
- **Program Scans** – Print a record of you register program.
- **Program Down** – Using IRC, You can program Down

Default Programming

Each HK-SYSTEMS ECR is ready to use after un-boxing, loading the paper and completing the memory all clear procedure (see “Clearing Memory” on page 26.)

- All keyboard PLU's are nontaxable and preset, with a “0” price.
- All system options are set to default. Change only the options that will deviate from default programming.
- All programming (unless otherwise noted) is done with the control lock in the PGM position. Each section details a specific area of register programming.

Descriptor Programming Methods

Descriptors can be programmed for PLU's, function keys, groups, clerks and the logo/messages. Two methods are available to program descriptors, the Program Overlay Method and the Descriptor Code Method. This chapter describes both methods. Refer to each program area for specific steps for programming PLU's, groups, function keys, etc.

Descriptor Overlay Method

This method is the default descriptor program method. When the descriptor field is selected on the program screen, you can simply type the descriptor placing a copy of the overlay over the keyboard. Press **CASH** to finalize your descriptor.

Program Example (HK- 7200 Keyboard)

To program the descriptor "20%" type:

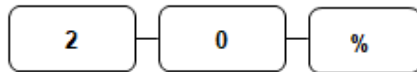

To use BACK and program the descriptor "Apple" type:



To program the descriptor "Apple" type:



NOTE: Use the CAPS key to toggle between upper and lower-case descriptor options.

To program the descriptor "APPLE" with DOUBLE (wide) characters type:



NOTE: Use the DOUBLE to toggle to between double and normal size descriptor options.

Program Example (HK- 7240 Keyboard)

To program the descriptor "20%" type:

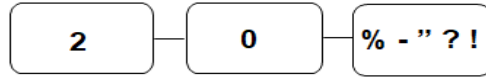

To program the descriptor "Apple" type:

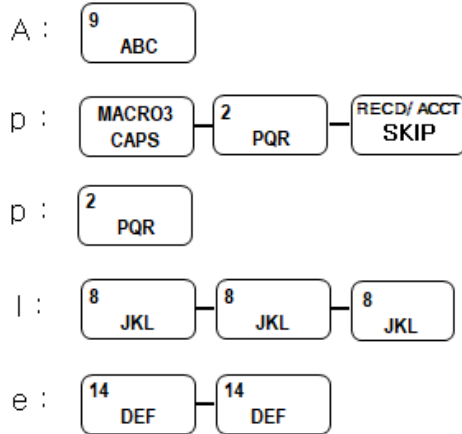

Program Example (HK- 7215 Keyboard)

To program the descriptor "20%" type:

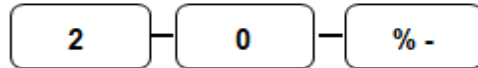

To program the descriptor "Apple" type:

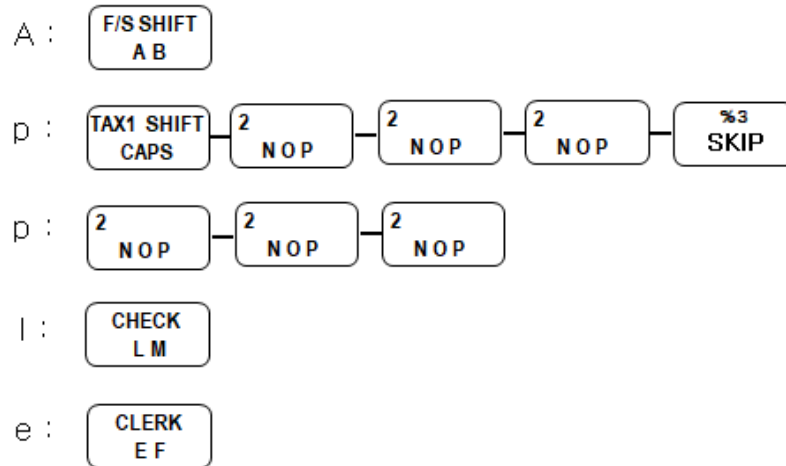

HK-7200 Keyboard Overlay

<	>	?	=												
!	@	#	\$	%	^	&	*	()	-					
Q	W	E	R	T	Y	U	I	O	P	+					
A	S	D	F	G	H	J	K	L	;	'					
Z	X	C	V	B	N	M	,	.	/	:		EXIT			
CAPS	DOBULE	SAPCE	SAPCE	SAPCE	SAPCE	SAPCE	SAPCE	DOBULE	BACK SAPCE	"		4	5	6	
												1	2	3	
												0	00	.	ENTER

HK-7240 Keyboard Overlay

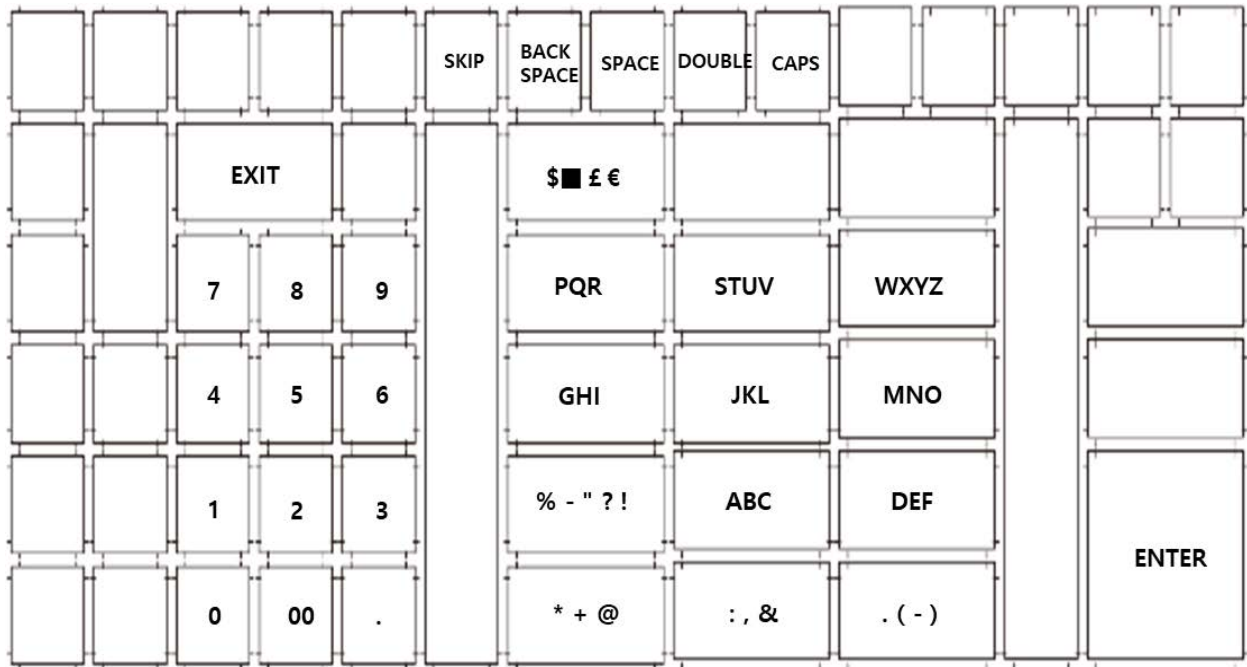

HK-7215 Keyboard Overlay

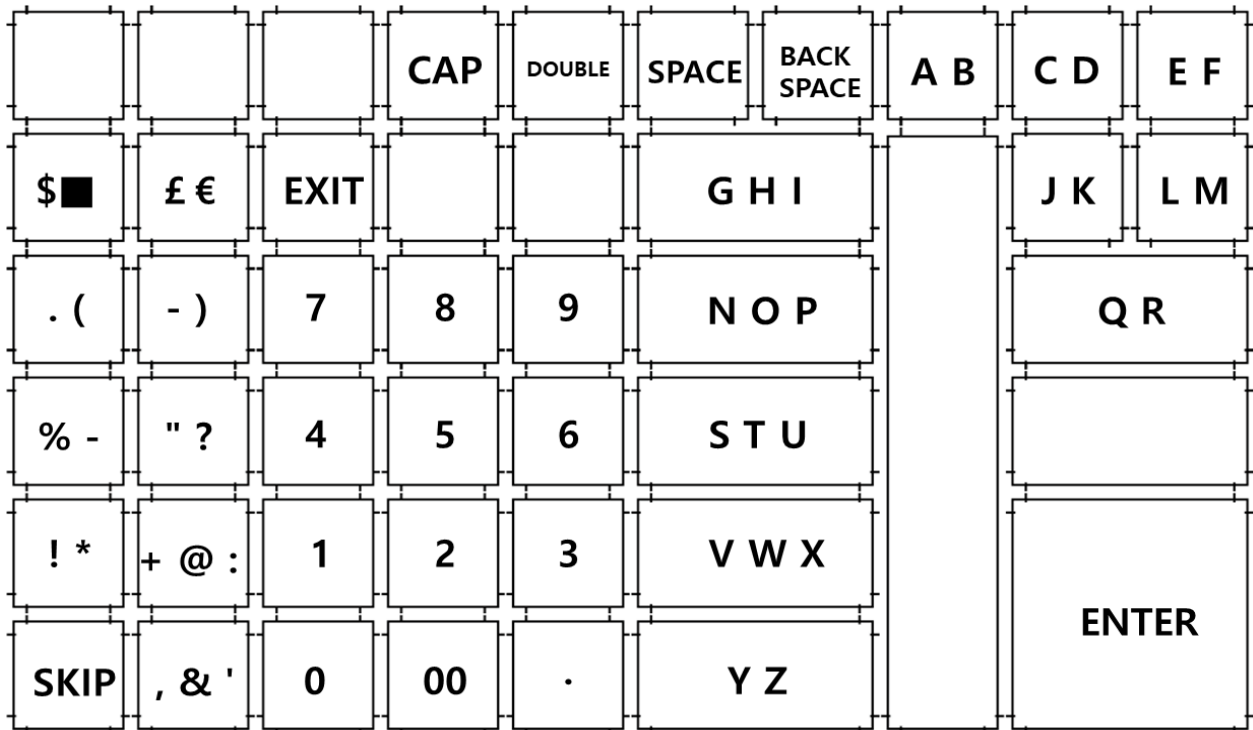

Descriptor Code Method

If you customize your keyboard by covering key locations, or by installing double or quad size keys, you will need to program descriptors using the descriptor code method. See “SYSTEM Options” on page 156. You must set the “DESC. PGM METHOD” option to be CODE TYPE.

Program Sequence

1. With the cursor pointed at a descriptor field, refer to the Descriptor Code Chart below and type the code for the first character.
2. For each additional character, type the code. Each character will be displayed as it is entered.
3. Press **CASH** when the descriptor is complete.

Program Example

To program the descriptor "APPLE", type:

[065] [080] [080] [076] [069] [CASH]

A P P L E

For DOUBLE (wide) characters enter **999** after the descriptor code. For example:

Ⓐ = [999] [065] [CASH]

Descriptor Code Table

Char.	Ç	ü	é	â	ä	à	å	ç	ê	ë
Code	001	002	003	004	005	006	007	008	009	010
Char.	è	ï	î	ì	Ä	Å	É	æ	Æ	ô
Code	011	012	013	014	015	016	017	018	019	020
Char.	ö	ò	û	ù	ÿ	Ö	Ü	·	£	¥
Code	021	022	023	024	025	026	027	028	029	030
Char.	€	SPACE	!	"	#	\$	%	&	'	(
Code	031	032	033	034	035	036	037	038	039	040
Char.)	*	+	,	-	.	/	0	1	2
Code	041	042	043	044	045	046	047	048	049	050
Char.	3	4	5	6	7	8	9	:	;	<
Code	051	052	053	054	055	056	057	058	059	060
Char.	=	>	?	@	A	B	C	D	E	F
Code	061	062	063	064	065	066	067	068	069	070
Char.	G	H	I	J	K	L	M	N	O	P
Code	071	072	073	074	075	076	077	078	079	080
Char.	Q	R	S	T	U	V	W	X	Y	Z
Code	081	082	083	084	085	086	087	088	089	090
Char.							a	b	c	d
Code	091	092	093	094	095	096	097	098	099	100
Char.	e	f	g	h	i	j	k	l	m	n
Code	101	102	103	104	105	106	107	108	109	110
Char.	o	p	q	r	s	t	u	v	w	x
Code	111	112	113	114	115	116	117	118	119	120
Char.	y	z	BACK SPACE			DOUBLE				
Code	121	122	123			999				
Char.	Á	á	Ñ	ñ	Ã	ã				
Code	125	126	127	128	129	130				

Program Mode Menu

1. Move to the **PROGRAM MODE**. The **PROGRAM MODE** menu displays.

```
PROGRAM MODE
1 . PLU
2 . GROUP
3 . FUNCTION KEY
4 . OPTIONS
5 . EMPLOYEE
6 . TIME
-PAGE 1 / 2-
```

2. Press the **↑** key and the **↓** key to select menu and press the **CASH** key to confirm. You can also select menu by **page↑** key and **page↓** key.

```
PROGRAM MODE
7 . TAXES
8 . MESSAGES
9 . MIX & MATCH
10 . PGM SCAN
11 . PROGRAM DOWN
-PAGE 2 / 2-
```

PLU Programming

To accommodate UPC barcode scanning, each PLU can be given an identifying number up to 14 digits in length.

1. At the **PROGRAM MODE**, press **1** and **CASH** for PLU Programming. The **PLU PROGRAMMING** screen displays:

```
                PLU
1 . ADD / CHANGE      ←
2 . DELETE
3 . PLU STOCK
4 . NLU CODE# PGM

                - PAGE 1 / 1 -
```

2. Use the ↓ and the ↑ keys to scroll up and down through the **PLU** menu. Or, you can enter the digit (1-4) directly. Press **CASH** to enter the programming area.

Add/Change PLU

Add/change One PLU

1. From the PLU PROGRAMMING screen; Press **1** and **CASH** to add or change a PLU screen:

```
ADD / CHANGE
1 . ONE PLU
2 . RANGE PLU
```

2. Press **1** and **CASH** to select individual PLU. The PLU NUMBER screen displays:

```
ADD / CHANGE
ENTER PLU #
0
```

3. Enter PLU number and **CASH** to select individual PLU. The PLU OPTION screen displays:
4. Refer to “PLU Options - Reference Information” on page 125 to make program entries or changes, press the **CLEAR** key to finalize and return to the previous screen.

Add/change Range PLU

1. From the ADD/CHANGE screen; Press **2** and **CASH** to select RANGE PLU. The PLU NUMBER screen displays:

```
ADD / CHANGE
ENTER FROM PLU #
0
```

2. Enter FROM PLU number and **CASH** to display TO PLU# screen:

```
ADD / CHANGE
ENTER FROM PLU #
1
ENTER TO PLU#
20
```

3. Enter TO PLU number and **CASH** to display PLU OPTIONS.
4. Refer to “PLU Options - Reference Information” on page 125 to make program entries or changes, press the **CLEAR** key to finalize and return to the previous screen.

PLU Options - Reference Information

Option	Entry	Description
DESC	Alpha numeric 18 character	You can program a descriptor for each PLU. Type the descriptor using the Program Overlay, or by using the descriptor code method (see page 120.) The overlay is automatically activated when the cursor is pointing at the DESC field. The default descriptors are PLU1, PLU2, etc.
PRICE/HALO1 PRICE/HALO2	7-digit amount	Up to five price levels are available. (Note that price level fields 2 will display only if you allocate memory for additional price levels.) If the PLU is open, the amount entered here is the high amount lock out (HALO). You can limit errors by setting the maximum amount that can be entered into a PLU. If the PLU is preset, the amount entered here is the amount that is registered automatically when the PLU is entered.
PRESET	Y or N	Choose Y for a preset PLU. Choose N for an open PLU. Open PLU's accept amount entries. Use open PLU's to enter different priced items into the same PLU. Preset PLU's automatically register a preprogrammed price when the PLU is entered. Use preset PLU's to register an individual item quickly and accurately. For example, cigarette packs can be assigned to PLU's.
PRESET OVERRIDE	Y or N	If Y , you can enter a price to override the preset price.
TAXable BY TAX1 TAXable BY TAX2 TAXable BY TAX3 TAXable BY TAX4	Y or N	Select N for non-taxable items. Select Y to apply the appropriate tax automatically for this PLU.
FOOD STAMP ELIGIBLE	Y or N	Select Y here if the item can be paid with food stamps or EBT.
GROUP #1 GROUP #2 GROUP #3	0-99	For each of three group assignments, enter a group where this PLU's sales will accumulate. The number of groups available is determined by memory allocation.
NEGATIVE ITEM	Y or N	Select Y to register items that subtract, rather than add to the sale total.
HASH	Y or N	Items designated with HASH status add to the current sale, but do not add to the registers grand total. HASH items may or may not add to the net sales total - see "SYSTEM Options" of "Options Programming" in the "Program Mode Programming" chapter. Use hash for lottery sales or bottle deposits.
SINGLE ITEM	Y or N	Select Y for a single item PLU. Single item PLU's automatically total as a cash sale immediately after the PLU entry. Single item PLU's are used to speed up one item sales.
NON-ADD # COMP	Y or N	Select Y to enforce the entry of a non-add number before a registration can be made.

Option	Entry	Description
GALLONAGE ITEM	Y or N	Select Y to compute gallons sold. The gallons sold will print along with the price entry on the receipt. The total gallons sold will accumulate in the PLU counter. You must program the price per gallon (in tenths of a cent, i.e. \$1.299 for \$1.29 and 9/10) in the PRICE/HALO field.
INVENTORY ITEM	Y or N	Select Y if you wish to track the number of items remaining in inventory using the Stock report.
DISABLE	Y or N	Select Y to disable the PLU. Entries cannot be made into disabled PLU's.
SCALABEL	Y or N	If Y , the PLU will work only when you are multiplying a weight from an optional scale or when multiplying a manually entered weight. (For example, enter weight, press SCALE , then register PLU.)
AUTO SCALE	Y or N	Select Y if you wish entries into this PLU to be automatically multiplied by the weight on the optional scale.
CONDIMENT	Y or N	Select Y if you wish the item to act like a condiment on the kitchen printer. Items with this status will satisfy the requirements of items with compulsory condiment status.
COMPULSORY CONDIMENT	Y or N	Select Y if you wish to force the entry of a condiment after this item is entered.
PRINT ON RECEIPT	Y or N	Select N if you wish to suppress printing of the item on the receipt.
DISPLAY PLU	Y or N	Select Y if you wish the PLU to show on the display.
PRINT ON CHECK	Y or N	Select N if you wish to suppress printing of the item on the check.
PRT PRICE ON RECEIPT	Y or N	Select N if you wish to suppress printing of the item's price on the receipt.
PRT PRICE ON CHECK	Y or N	Select N if you wish to suppress printing of the item's price on the check.
DISABLE PROMO	Y or N	Select Y to block the PROMO function on this PLU.
COUNTER NOT RESET	Y or N	Select Y if you do not wish to reset the PLU item counter on the Z PLU report.
PRESET OVERRIDE IN MGR CONTROL	Y or N	If preset override is Y , then you can force manager control for preset override by setting this option to Y .
DISABLE RETURN & VOID	Y or N	If Y , you cannot correct this PLU through void operations (Void Item/ Error Correct/VOID Mode) or perform a merchandise return of this PLU item. The Y value is recommended when using liquor control systems.
PRICE CHANGE ITEM	Y or N	Select Y to change price on this PLU.
ALLOW DISCOUNTS	Y or N	Select Y to allow Discounts on this PLU.
PRINT ON JOURNAL	Y or N	Select N if you wish to suppress printing of the item's price on the journal.

Option	Entry	Description
PRINT PRICE ON JOURNAL	Y or N	Select N if you wish to suppress printing of the item's price on the journal.
AUTO TARE	1-5	Select Y if you wish entries into this PLU to be automatically multiplied by the weight on the optional scale.
MIX & MATCH	0-99	Enter a value (1-99) to indicate the number of the preprogrammed MIX&MATC TABLE. Enter 0 to disable
LINK PLU:	14 digits maximum	If you wish the registration of this PLU to automatically cause the registration of another PLU, enter the PLU # you wish to link with the 10-key pad. Enter 0 for no link.
QTY/MODIFIER1 QTY/MODIFIER2	0-99.99	Enter quantity modifier count.
MINIMUM STOCK	0-9999.99	Enter Minimum Stock amount.

Delete PLU

Note: Before a PLU can be deleted, all report information must be cleared. It may be necessary to run a Z1 and Z2 PLU Report, and if the PLU is an inventory item, you must change the stock to zero.

If PLU's had been registered by using the NOT FOUND PLU function, RESET N.F. PLU must be issued. See page 76 for details.

Delete One PLU

1. From the **PLU PROGRAMMING** screen, press **2** and **CASH** to display the **DELETE PLU** screen:

DELETE
1 . ONE PLU
2 . RANGE PLU

2. Press **1** and **CASH** to delete an individual PLU. The **PLU NUMBER** screen displays:

DELETE
ENTER PLU #
0

3. Enter the number of the PLU you wish to delete and press **CASH**. The **DELETE** message will print.

Delete PLU Range

1. From the **PLU PROGRAMMING** screen, press **2** and **CASH** for to display the **DELETE PLU** screen:

DELETE
1 . ONE PLU
2 . RANGE PLU

2. Press **2** and **CASH** to delete a range of PLU's. The **PLU NUMBER** screen displays: Enter the number of FROM PLU# in the range you wish to delete. Press **CASH**.

DELETE
ENTER FROM PLU#
0

3. Enter the number of TO PLU# in the range you wish to delete.

DELETE
ENTER FROM PLU #
1
ENTER TO PLU #
20

4. Press **CASH** to delete the PLU. The **DELETE** message will print.
5. Continue to delete other PLU'S or press **CLEAR** key until you are returned to the **PROGRAM MODE** menu.

PLU STOCK

Note: Before program PLU stock, 'Inventory Item' option set as 'Y' in PLU programming.

1. From the **PLU PROGRAMMING** screen, press **3** and **CASH** to display the **PLU STOCK** screen:

```
          PLU STOCK
1 . ONE
2 . RANGE
```

2. Select the PLU or PLU's you wish to program one of the following ways.

ONE PLU

1. From the **PLU STOCK** screen, press **1** and **CASH** to add an individual PLU. The **PLU NUMBER** screen display:

```
          STOCK ENTRY
ENTER PLU #
                                0
```

RANGE PLU

1. From the **PROGRAM** screen, press **2** and **CASH** to display **RANGE PLU** screen.

```
          STOCK ENTRY
ENTER FROM PLU #
                                0
```

2. Enter **FROM PLU#** number and **CASH** to display **TO PLU#** screen:

```
          STOCK ENTRY
ENTER FROM PLU#
                                1
ENTER TO PLU#
                                20
```

3. Enter **TO PLU#** number and **CASH** to display **STOCK ENTRY** screen:

```
          STOCK ENTRY
OPERATOR:  ADD (+)
           ADD (+)
```

4. Select operator **ADD (+)**, **SUB (-)** or **REPLACE**.
5. Enter the stock quantity you wish to **ADD/SUBTRACT/REPLACE**, and press **CASH**. Note that stock is kept in decimal units and you must enter new or additional stock to two digits beyond the decimal. For example, type **1 0 0 0** to enter ten units of inventory.
6. To program additional PLU's repeat step 5 or press **CLEAR** key to finalize.

NLU Code# Program

NLUs are fixed keys on the keyboard (like traditional department keys) that access specific PLU's.

On the default keyboard the PLU# assigned to the NLU key is the same, i.e. NLU key number one is PLU #1. However, with this program, you can assign any PLU number you wish to any one of the NLU keys.

1. From the **PLU PROGRAMMING** menu, press **4** and **CASH** for **NLU CODE# PGM**. The **NLU CODE PROGRAM** screen displays:

```
      NLU CODE# PGM
ENTER NLU KEY
```

2. Press the NLU key on the keyboard you wish to program or press **CLEAR** to exit.

```
      NLU CODE# PGM
NLU# 1
ENTER NEW PLU #
                                0
```

3. The current PLU code number displays. Type the new PLU code number you wish to use for this NLU key, press **CASH**.
4. The **NLU CODE PROGRAM** screen returns. Continue from step 1 to program additional NLU keys or press **CLEAR** to exit.

Group Programming

Up to 99 groups (*the exact number is determined by memory allocation*) are available to summarize PLU sales. Group totals appear on reports, so that you can track sales of different types of items.

- The group descriptors programmed here will replace the default descriptors GROUP 1 through GROUP 99 that appear on reports.
- Each PLU can report totals to one, two or three different groups. If a PLU sends totals to more than one group, the group total that appears on the Group report will not represent PLU sales. Therefore, you also have the option of deciding whether each group's total will add to the group total on the Group report.

To Program Groups

1. At the **PROGRAM MODE**, press **2** and **CASH** for **GROUP**. The **GROUP PROGRAMMING** screen displays: (The maximum group number is set by memory allocation.)

GROUP	
ENTER GROUP #	
(1 - 1 0)	0

2. Enter the number of the group to be programmed, press the **CASH**. The **GROUP# PROGRAMMING** screen displays:

GROUP	
1 . DESC :	[GROUP 01]
2 . ADD TO GROUP TOTAL	[Y]
3 . SEND TO KP	[N]
4 . KP PORT# : RCPT	[N]
5 . KP PORT# : 1	[N]
6 . KP PORT# : 2	[N]

GROUP	
7 . PRINT RED ON KP	[N]

3. Press the **↑** key and the **↓** key to select menu and press the **CASH** key to confirm. You can also select menu by **page ↑** key and **page ↓** key. Select the Group option you wish to program.
4. Press the **↑** key for YES and the **↓** key for NO.
Press **CLEAR** to return to the GROUP PROGRAMMING screen. Continue to program groups as necessary. Press **CLEAR** to return to the PROGRAM MODE screen.

Group Programming - Reference Information

Option	Entry	Description
DESC	Alpha numeric 18 character	You can program a descriptor for each group. Type the descriptor using the Program Overlay or by using the descriptor code method (see page 120.). The overlay is automatically activated when the cursor is pointing at the DESC field. The default descriptors are GROUP 01, GROUP 02, etc.
ADD TO GROUP TOTAL	Y or N	Select N if you do not wish this groups total to be added to the total of all groups on the Group report.
SEND TO KP	Y or N	Select Y if you wish to send PLU's reporting to this group to a kitchen printer.
KP PORT #: RECEIPT	Y or N	Select Y if you wish to print a kitchen requisition at the register.
KP PORT #: 1	Y or N	Select Y if you wish to print a kitchen requisition at the Port1.
KP PORT #: 2	Y or N	Select Y if you wish to print a kitchen requisition at the Port2.
PRINT RED ON KP	Y or N	Select Y if you wish items reporting to this group to print in red on the kitchen printer. (Note, the kitchen printer must have red/black printing capability, and this option does not apply to the register receipt printer.)

Function Key Programming

Use to set specific options for function keys. Because of the differences inherent in function keys, individual options will be different. See the specific instructions for each key in this chapter to find the options for each key.

1. From the **PROGRAM MODE**, press **3** and **CASH** for **FUNCTION KEY**. The **FUNCTION KEY PROGRAM** screen displays:

```
FUNCTION KEY
1.FUNCTION KEY
2.MACRO KEY

-PAGE 1 / 1-
```

2. Press **1** and **CASH** to select **FUNCTION KEY** menu.

```
FUNCTION KEY
ENTER FUNC.KEY
TO BE PROGRAMMED
```

3. Press the function key you wish to program.
4. For example, Press the **#/NS** key to view the **#/NS** function key options:
5. Press the **↓** key to view the next menu. Press the **↑** key to view the previous menu. Press the **PAGE↓** key to view the next page. Press the **PAGE↑** key to view the previous page.
6. Press the **CASH** to set option value.
7. From the YES/No type option screen, Press the **↑** key for YES and the **↓** key for NO. Press the **CASH** to confirm the option value.
8. Press **CLEAR** at any time to return to the **FUNCTION KEY** menu without saving changes.

#/NS Function Options

Option	Entry	Description
DESC1	Alpha numeric 18 character	You can program a unique descriptor for the no sale function. The default descriptor is NOSALE.
DESC2	Alpha numeric 18 character	You can program a unique descriptor for the non add # function. The default descriptor is NON ADD #.
#/NS DISABLE	Y or N	Select Y to disable the no sale function (non-add entries are allowed).
UNDER MANAGER CONTROL	Y or N	Select Y to allow operation only in manager operation mode.
INHIBIT NO SALE AFTER NON-ADD #	Y or N	Select Y if you want to disable the NO SALE function after a non-add number is entered.
COMP. # AT START OF SALE	Y or N	Select Y if you wish to enforce the entry of a non-add number at the beginning of each transaction. (For example, to track the number of customers in each sale or to identify a customer number with each sale.)
PRINT ON N/S	Y or N	Select N to stop printing when a NO SALE is performed.
NON-ADD # PROHIBIT	Y or N	Select Y to disable the non-add # function.
COMP NON-ADD # MUST MATCH MAX DIGIT	Y or N	Select Y if you wish all non-add number entries to have the exact number of digits selected in the MAX DIGIT flag below.
MAX DIGIT	0-8	Enter the maximum number of digits for non-add number entry. Zero (0) means no limit.

%1 -%5 Function Options

Option	Entry	Description
DESC	Alpha numeric 18 character	You can program a unique descriptor. The default descriptors are % 1-4.
AMOUNT:Y %:N	Y or N	Select Y if you wish for this key to apply an amount (as in a coupon). Select N if you wish for this key to apply the percentage (as in a discount or surcharge).
AMOUNT/RATE	5 digits	If the function is an amount, enter the amount from 0 to 999.99. If not zero, the amount will be the preset coupon amount. If the function is a percentage, enter a percentage from 0 to 99.999%. If not zero, the percentage will be the preset percentage
KEY DISABLE	Y or N	Select Y to disable this function.
UNDER MANAGER CONTROL	Y or N	Select Y if you do not want the operator to use this function in REGISTER mode. When selected, the function is allowed only in the MANAGER MODE .
OPEN:Y PRESET:N	Y or N	Select Y if you wish the amount or percentage to be entered by the operator; select N if you wish the amount or percentage to be preset.
SALE:Y ITEM:N	Y or N	Select Y if you wish the amount or percentage to apply to the sale total. Select N if you wish the amount or percentage to apply to an item.
OVERRIDEABLE	Y or N	Select Y if you wish to enter a percentage or amount to override the preset percentage or amount set in the RATE field.
POS.:Y NEG.:N	Y or N	Select Y if you wish for the amount or percentage to add to the sale total. Select N if you wish for the amount or percentage to subtract from the sale.
TAXable BY TAX1 TAXable BY TAX2 TAXable BY TAX3 TAXable BY TAX4	Y or N	Select N to tax any taxable items before the discount or surcharge is applied (tax the gross amount). Select Y to tax any taxable items after the discount or surcharge is applied (tax the net amount).
ALLOW ONLY ONE TIME SUBTOTAL ENTRY	Y or N	If Y , you can enter only a single coupon and you must press the SUBTOTAL key before the coupon entry.
ALLOW MULTIPLE AMOUNT DISCOUNT (COUPON) WITHOUT SUBTOTAL ENTRY	Y or N	If you set a % key to be used for vendor coupons (i.e. amount, negative and sale status) then choose Y to allow the function to be operated multiple times, without requiring the SUBTOTAL key to be pressed prior to the coupon entry.
PRESET OVERRIDE IN MGR ONLY	Y or N	Select Y to allow preset override only in manager operation mode.
COMPULSORY VALIDATION	Y or N	Choose Y to enforce validation if an optional printer with validation capability is connected to a Serial port.

ADD CHECK Key Program Notes

Option	Entry	Description
DESC	Alphanumeric 18 character	You can program a unique descriptor. The default descriptor is ADD CHECK.
KEY DISABLE	Y or N	Select Y to disable this function.
COMPULSORY BEFORE TENDERING	Y or N	Select Y if you want to force the operator to use the ADD CHECK function before tendering.
ADVANCE THE CONSECUTIVE #	Y or N	Select Y if you want to advance the consecutive number each time the ADD CHECK key is used.
DELETE THE PRE/POSTAMBLE	Y or N	Select Y if you want to delete the preamble and postamble each time the ADD CHECK key is used.
EXEMPT TAX 1 EXEMPT TAX 2 EXEMPT TAX 3 EXEMPT TAX 4	Y or N	Select Y to exempt the appropriate tax automatically when finalized with this key.
COMPULSORY VALIDATION	Y or N	Choose Y to enforce validation if an optional printer with validation capability is connected to an RS-232C port.

CANCEL Key Program Notes

Option	Entry	Description
DESC	Alpha- numeric 18 character	You can program a unique descriptor. The default descriptor is CANCEL.
HALO	7-digits (amount)	You can limit errors by setting the maximum amount that can be used with this function. "0" means that there is no entry limit.
KEY DISABLE	Y or N	Select Y to disable this function.
UNDER MANAGER CONTROL	Y or N	Select Y if you do not want the operator to use this function in REGISTER MODE . When selected, the function is allowed only in the MANAGER MODE .
COMPULSORY VALIDATION	Y or N	Choose Y to enforce validation if an optional printer with validation capability is connected to an RS-232C port.

CASH Key Program Notes

Option	Entry	Description
DESC	Alphanumeric 18 Character	You can program a unique descriptor. The default descriptor is CASH.
HALO	7-digit amount	You can limit errors by setting the maximum amount that can be tendered. "0" means that there is no entry limit.
AMOUNT TEND COMP.	Y or N	Select Y if you want to force the operator to enter the tendered amount and let the register calculate the change.
OVER/UNDER TENDER IN MGR CONTROL	Y or N	Select Y if you do not want the operator to tender more than the amount of the sales and issues to be changed. When selected, over and under tendering is allowed only in the MANAGER MODE .
DISABLE UNDER TEND.	Y or N	Select Y if you do not want the operator to tender less than the amount of the sale.
DOES DRAWER OPEN	Y or N	Select N if you do not want the drawer to be opened with this key.
EXEMPT TAX 1 EXEMPT TAX 2 EXEMPT TAX 3 EXEMPT TAX 4	Y or N	Select Y to exempt the appropriate tax automatically when finalized with this key.
COMPULSORY VALIDATION	Y or N	Choose Y to enforce validation if an optional printer with validation capability is connected to an RS-232C port.

CHARGE 1-8 Keys Program Notes

Option	Entry	Description
DESC	Alpha-numeric 18 character	You can program a unique descriptor. The default descriptors are CHARGE 1-8.
HALO	7-digit amount	You can limit errors by setting the maximum amount that can be tendered. "0" means that there is no entry limit.
AMOUNT TEND COMP.	Y or N	Select Y if you want to force the operator to enter the tendered amount and let the register calculate the change.
OVER/UNDER TENDER IN MGR CONTROL	Y or N	Select Y if you do not want the operator to tender more than the amount of the sale and issue change. When selected, over tendering is allowed only in the MANAGER MODE .
DISABLE UNDER TEND.	Y or N	Select Y if you do not want the operator to tender less than the amount of the sale.
DOES DRAWER OPEN	Y or N	Select N if you do not want the drawer to be opened with this key.
ALLOW OVER TEND.	Y or N	Select Y if you wish to allow tender greater than the amount of the sale.
NON-ADD # ENTRY COMPULSORY	Y or N	Select Y if you wish to enforce the entry of a non-add number prior to tendering.
EXEMPT TAX 1 EXEMPT TAX 2 EXEMPT TAX 3 EXEMPT TAX 4	Y or N	Select Y to exempt the appropriate tax automatically when finalized with this key.
COMPULSORY VALIDATION	Y or N	Choose Y to enforce validation if an optional printer with validation capability is connected to an RS-232C port.
ALLOW ROUNDING	Y or N	Select Y if you wish to allow rounding when pressing the CHARGE1~CHARGE8 keys.

CHECK Key Program Notes

Option	Entry	Description
DESC	Alpha-numeric 18 character	You can program a unique descriptor. The default descriptor is CHECK.
HALO	7-digit amount	You can limit errors by setting the maximum amount that can be tendered. "0" means that there is no entry limit.
AMOUNT TEND COMP.	Y or N	Select Y if you want to force the operator to enter the tendered amount and let the register calculate the change.
OVER/UNDER TENDER IN MGR CONTROL	Y or N	Select Y if you do not want the operator to tender more than the amount of the sale and issue change. When selected, over tendering is allowed only in the MANAGER MODE .
DISABLE UNDER TEND.	Y or N	Select Y if you do not want the operator to tender less than the amount of the sale.
DOES DRAWER OPEN	Y or N	Select N if you do not want the drawer to be opened with this key.
EXEMPT TAX 1 EXEMPT TAX 2 EXEMPT TAX 3 EXEMPT TAX 4	Y or N	Select Y to exempt the appropriate tax automatically when finalized with this key.
COMPULSORY CHECK ENDORSEMENT	Y or N	Choose Y to enforce check endorsement if an optional printer with endorsement capability is connected to an RS-232C port.
COMPULSORY VALIDATION	Y or N	Choose Y to enforce validation if an optional printer with validation capability is connected to an RS-232C port.

CHECK CASHING Key Program Notes

Option	Entry	Description
DESC	Alpha-numeric 18 character	You can program a unique descriptor. The default descriptor is CHKCASH.
HALO	7-digit amount	You can limit errors by setting the maximum amount that can be used with this function. "0" means that there is no entry limit.
KEY DISABLE	Y or N	Select Y to disable this function.
UNDER MANAGER CONTROL	Y or N	Select Y if you do not want the operator to use this function in REGISTER MODE . When selected, the function is allowed only in the MANAGER MODE .
COMPULSORY VALIDATION	Y or N	Choose Y to enforce validation if an optional printer with validation capability is connected to an RS-232C port.
COMPULSORY CHECK ENDORSEMENT	Y or N	Choose Y to enforce check endorsement if an optional printer with validation capability is connected to an RS-232C port.

CHECK ENDORSEMENT Key Program Notes

Option	Entry	Description
DESC	Alpha-numeric 18 character	You can program a unique descriptor. The default descriptor is CHKENDOR.
KEY DISABLE	Y or N	Select Y to disable this function.
UNDER MANAGER CONTROL	Y or N	Select Y if you do not want the operator to use this function in REGISTER MODE . When selected, the function is allowed only in the MANAGER MODE .
PRINT CHECK AMT IN THE ENDORSEMENT	Y or N	Choose Y to print the amount of check as well as the endorsement message. Choose N to print only the endorsement message. Note: A 10-line check endorsement message may be programmed. See "Endorsement" programming on page 178 for more information.
PRINT DATE	Y or N	Select N to suppress printing Date on the check endorsement.
PRINT TIME	Y or N	Select N to suppress printing Time on the check endorsement.
PRINT CLERK	Y or N	Select N to suppress printing the Clerk name on the check endorsement.
PRINT CONSECUTIVE No	Y or N	Select N to suppress printing the Consecutive number on the check endorsement.
SLIP OUTPUT PORT	0-2	If validation is used, identify the communications port (1 or 2) where the validating printer is attached. Enter 0 if validation is not used.

CHECK # Key Program Notes

Option	Entry	Description
DESC	Alpha-numeric 18 character	You can program a unique descriptor. The default descriptor is CHKTRACK.
KEY DISABLE	Y or N	Select Y to disable this function.
COMPULSORY FOR ALL SALES	Y or N	Select Y you must begin a new or recall an existing tracking number before registering items.
OPENING CLERK HAS EXCLUSIVE ACCESS	Y or N	If Y , the clerk that begins a tracking number is the only clerk who can recall a check. If N , any clerk can recall any check.
PRINT ON RECEIPT	Y or N	If N , the check track number and balance will not print on the receipt.
PRINT CHECK ON RP	Y or N	If N , the check track number and balance will not print on the remote.
ALLOW ONLY ONE CHK PER TABLE	Y or N	If Y , you can begin only one check with the same table #.
CHECK # ASSIGNED BY REGISTER	Y or N	If Y , press the CHECK. # key to automatically assign the next sequential check. Check numbers will begin with #1 and continue until the open check report is reset, at which point the check number will be reset and start from #1 again.
PBAL IS USED D/THRU RECALL	Y or N	If you wish to implement a drive thru recall key, this setting changes the function of the PBAL key to that of a recall key. Press the PBAL key directly to automatically recall the open check with the lowest tracking number
LENGTH OF CHECK	0-9	Set the length of check in number of digits. For example, if 4, then checks must be used in the range from 1000, to 9999. This setting applies to only check numbers input by the operator, not to check numbers assigned by the register.

CURRENCY CONVERSION 1-4

Currency Exchange Rate Programming Examples

Note: Foreign currency exchange rates can be stated as “foreign currency in dollars”, or “dollars in foreign currency”. Use the rate stated in “dollars in foreign currency” when you are programming this section.

The US dollar (home currency) is worth 1.3720 Canadian dollars (foreign currency).

RATE: 13720 NUMBER OF DEC.: 4

The US dollar (home currency) is worth 110.24 Japanese Yen (foreign currency).

RATE: 11024 NUMBER OF DEC.: 2

CURRENCY CONVERSION 1-4 Keys Program Notes

Option	Entry	Description
DESC	Alphanumeric 18 character	You can program a unique descriptor for each foreign currency. The default descriptors are CONV 1-4.
EXCHANGE RATE	7 digits	Enter the exchange rate of up to 7 digits (do not enter the decimal point). See the examples.
DECIMAL PLACE	0 - 4	Enter a number from 0 to 4 to indicate the decimal position of the exchange rate. Count the decimal position from the right. See the examples below.

EAT-IN, TAKE OUT, DRIVE THRU Key Program Notes

Option	Entry	Description
DESC	Alphanumeric 18 character	You can program a unique descriptor. The default descriptors are EATIN, TAKE OUT and DRIVE THRU.
EXEMPT TAX 1 EXEMPT TAX 2 EXEMPT TAX 3 EXEMPT TAX 4	Y or N	If you wish to automatically exempt a tax for a particular type of sale, select Y for the appropriate tax. For example, if items are non-taxable for take-out, but taxable for eat-in, set this program to exempt tax on take out sales.
COMPULSORY VALIDATION	Y or N	Choose Y to enforce validation if an optional printer with validation capability is connected to an RS-232C port.

ERROR CORRECT Key Program Notes

Option	Entry	Description
DESC	Alpha-numeric 18 character	You can program a unique descriptor. The default descriptor is ERRCORR.
HALO	7-digit amount	You can limit errors by setting the maximum amount that can be tendered. "0" means that there is no entry limit.
KEY DISABLE	Y or N	Select Y to disable this function.
UNDER MANAGER CONTROL	Y or N	Select Y if you do not want the operator to use this function in REGISTER MODE . When selected, the function is allowed only in the MANAGER MODE .
COMPULSORY VALIDATION	Y or N	Choose Y to enforce validation if an optional printer with validation capability is connected to an RS-232C port.

GUEST Key Program Notes

Option	Entry	Description
DESC	Alpha-numeric 18 character	You can program a unique descriptor. The default descriptor is GUEST.
COMPULSORY FOR GUEST CHECK	Y or N	Select Y to enforce an entry into the GUEST # key before a tracking number can be accessed for the first time.
COMPULSORY FOR ALL SALES	Y or N	Select Y to enforce an entry into the GUEST # key before an item can be registered on any sale.
PRINT AT REMOTE PRINTER	Y or N	Select N if you do not want GUEST # entry to print at the kitchen printer when items from the same transaction are sent to the KP.

PRICE LEVEL 1-2 Key Program Notes

Option	Entry	Description
DESC	Alpha-numeric 18 character	You can program a unique descriptor. The default descriptors are LEVEL1, LEVEL2, etc.
SEND DESCRIPTION TO KP	Y or N	Determines whether the level descriptor will be printed with the item at the KP.
KEY DISABLE	Y or N	Select Y to disable this function.
UNDER MANAGER CONTROL	Y or N	Select Y if you do not want the operator to use this function in REGISTER MODE . When selected, the function is allowed only in the MANAGER MODE .
PRINT ON GUEST CHECKS	Y or N	Select Y to print level descriptor on Guest Check.
PRINT ON RECEIPT	Y or N	Select Y to print level descriptor on receipt.
PREVENT ZERO PRICE SALE	Y or N	Select Y if you do not want register zero price items.
ALTERNATIVE ZERO PRICE LEVEL	0-2	Choose price level to use if PLU price is zero.

RETURN Key Program Notes

Option	Entry	Description
DESC	Alpha-numeric 18 character	You can program a unique descriptor. The default descriptor is MDSE RETURN.
HALO	7-digit amount	You can limit errors by setting the maximum amount that can be used with this function. "0" means that there is no entry limit.
KEY DISABLE	Y or N	Select Y to disable this function.
UNDER MANAGER CONTROL	Y or N	Select Y if you do not want the operator to use this function in REGISTER MODE . When selected, the function is allowed only in the MANAGER MODE .
COMPULSORY VALIDATION	Y or N	Choose Y to enforce validation if an optional printer with validation capability is connected to an RS-232C port.

MODIFIER 1-5 Key Program Notes

Option	Entry	Description
DESC	Alpha-numeric 18 character	You can program a unique descriptor. The default descriptors are MOD1 - MOD5.
UNDER MANAGER CONTROL	Y or N	Select Y if you do not want the operator to use this function in REGISTER MODE . When selected, the function is allowed only in the MANAGER MODE .
AFFECT PLU #	Y or N	Select Y , if you wish the modifier entry to modify the PLU and cause a different item/price to be registered. Select N to only add the modifier descriptor.
PRINT ON RECEIPT	Y or N	Select N to suppress printing of the modifier descriptor on the receipt.
AFFECT DIGIT OF PLU #	1-14	Preceding a PLU with a Size and/or Modifier key manipulates the PLU code assigned to the PLU key, causing a different PLU to be registered when the PLU key is pressed. Enter the digit of the PLU number you wish to be changed when using this key. (Digit #1 is the rightmost digit; digit #14 is the leftmost digit.)
VALUE OF AFFECTED DIGIT (0-9)	0-9	Enter the value you wish to be added in the digit position selected. For example, if you wish to affect PLU digit #4 with a value of 1, then pressing this modifier key prior to the registration of PLU #17 will result in the registration of PLU #1017.

PBAL Key Program Notes

Option	Entry	Description
DESC	Alpha-numeric 18 character	You can program a unique descriptor. The default descriptor is PBAL.
ENTER ANY TIME	Y or N	Select Y to allow the PBAL entry at any time. Select N to allow a PBAL entry only at the start of a sale.
REQUIRE AT START OF SALE	Y or N	Select Y to require an entry into the PBAL key at the start of every transaction.

PAID OUT 1-3 Keys Program Notes

Option	Entry	Description
DESC	Alpha numeric 18 character	You can program a unique descriptor. The default descriptors are PO 1-3.
HALO	7-digit amount	You can limit errors by setting the maximum amount that can be used with this function. "0" means that there is no entry limit.
KEY DISABLE	Y or N	Select Y to disable this function.
UNDER MANAGER CONTROL	Y or N	Select Y if you do not want the operator to use this function in REGISTER MODE . When selected, the function is allowed only in the MANAGER MODE .
COMPULSORY VALIDATION	Y or N	Choose Y to enforce validation if an optional printer with validation capability is connected to an RS-232C port.

PRINT CHECK Key Program Notes

Option	Entry	Description
DESC	Alpha- numeric 18 character	You can program a unique descriptor. The default descriptor is PRINT CHECK.
CHECK PRINT COMM PORT # (0-2)	0-2	Select the port (1 or 2) where the check print printer is attached. If 0 is selected, the check will print on the receipt printer.
AUTO SERVICE CHK	Y or N	Select Y if you want the Check Print function to automatically service the check.
PRT CHECK ON RECEIPT	Y or N	Select Y if you want the Check Print function to print on the receipt printer.
SKIP PRT OF CONSEC# ON CHECK	Y or N	Select Y if you wish to delete the printing of the consecutive # on the guest check.

PROMO Key Program Notes

Option	Entry	Description
DESC	Alpha-numeric 18 character	You can program a unique descriptor. The default descriptor is PROMO .
KEY DISABLE	Y or N	Select Y to disable this function.
UNDER MANAGER CONTROL	Y or N	Select Y if you do not want the operator to use this function in REGISTER MODE . When selected, the function is allowed only in the MANAGER MODE .
TAXABLE BY TAX1 TAXABLE BY TAX2 TAXABLE BY TAX3 TAXABLE BY TAX4	Y or N	If an item is taxable and you wish to remove taxes and a cost of the item when using the PROMO key, set the taxable status for the appropriate tax to Y .

RECD ON ACCT 1-3 Keys Program Notes

Option	Entry	Description
DESC	Alpha-numeric 18 character	You can program a unique descriptor. The default descriptors are RA 1-3.
HALO	7-digit amount	You can limit errors by setting the maximum amount that can be used with this function. "0" means that there is no entry limit.
KEY DISABLE	Y or N	Select Y to disable this function.
UNDER MANAGER CONTROL	Y or N	Select Y if you do not want the operator to use this function in REGISTER MODE . When selected, the function is allowed only in the MANAGER MODE .
COMPULSORY VALIDATION	Y or N	Choose Y to enforce validation if an optional printer with validation capability is connected to an RS-232C port.

SCALE Key Program Notes

Option	Entry	Description
DESC	Alpha-numeric 18 character	You can program a unique descriptor. The default descriptor is SCALE.
KEY DISABLE	Y or N	Select Y to disable this function.
UNDER MANAGER CONTROL	Y or N	Select Y if you do not want the operator to use this function in REGISTER MODE . When selected, the function is allowed only in the MANAGER MODE .
KEY IS MAN. ENTRY	Y or N	Select Y if you wish to scale key to enter a manual weight. Select N if you wish to automatically recall the weight from the attached scale.
TARE-WEIGHT COMP.	Y or N	Select Y if you wish to enforce the subtraction of a tare weight on the scale entry.
MANUAL SYMBOL	LB, KG, OZ	Select KG if you wish to use the weight symbol Kg (kilogram). LB for pound / KG for kilogram / OZ for ounce measurements.

SERVICE Key Program Notes

Option	Entry	Description
DESC	Alphanumeric 18 character	You can program a unique descriptor. The default descriptor is SERVICE.
NON-ADD # COMP	Y or N	Select Y if you wish to force the entry of a non-add number (i.e. a tax exempt #) before the key is used
PRINT ON RECEIPT	Y or N	Select N to not print on the receipt.
NEGATIVE BALANCE IN MGR CONTROL	Y or N	Select Y if you do not want the operator to use this function in REGISTER MODE . When selected, the function is allowed only in the MANAGER MODE .
CALCULATE TAX1 CALCULATE TAX2 CALCULATE TAX3 CALCULATE TAX4	Y or N	Select Y to calculate and add the appropriate tax automatically when finalized with this key.
COMPULSORY VALIDATION	Y or N	Choose Y to enforce validation if an optional printer with validation capability is connected to an RS-232C port.
HARD CHECK PRINTER PORT	0-2	If you are using a hard check system, enter the RS232C port number (1 or 2) where the optional guest check printer is attached.

SUBTOTAL Key Program Notes

Option	Entry	Description
DESC	Alpha numeric 18 character	You can program a unique descriptor. The default descriptor is SUBTOTAL.
KEY DISABLE	Y or N	Select Y to disable this function.

TABLE Key Program Notes

Option	Entry	Description
DESC	Alpha- numeric 18 character	You can program a unique descriptor. The default descriptor is TABLE.
ENFORCE ON CHECK TRACK	Y or N	If Y , you must enter the table number before opening a new check track #.
ENFORCE ON ALL SALES	Y or N	If Y , you must enter the table number before beginning any transaction.
PRINT AT REMOTE PRINTER	Y or N	Choose Y to print the table number at the remote printer.

TARE Key Program Notes

Option	Entry	Description
DESC	Alpha- numeric 18 character	You can program a unique descriptor. The default descriptor is TARE.
KEY DISABLE	Y or N	Select Y to disable this function.
UNDER MANAGER CONTROL	Y or N	Select Y if you do not want the operator to use this function in REGISTER MODE . When selected, the function is allowed only in the MANAGER MODE .
#5 IS MANUAL TARE	Y or N	Choose Y to use tare number five to manually enter a tare weight.

TAX EXEMPT Key Program Notes

Option	Entry	Description
DESC	Alpha-numeric 18 character	You can program a unique descriptor. The default descriptor is TAXEXMT.
EXEMPT TAX 1 EXEMPT TAX 2 EXEMPT TAX 3 EXEMPT TAX 4	Y or N	Select Y or N for each tax to determine which tax or taxes are exempted when this key is used.
NON-ADD # COMP	Y or N	Select Y if you wish to force the entry of a non-add number (i.e. a tax exempt #) before the key is used.
COMPULSORY VALIDATION	Y or N	Choose Y to enforce validation if an optional printer with validation capability is connected to an RS-232C port.

TIP Key Program Notes

Option	Entry	Description
DESC	Alpha-numeric 18 character	You can program a unique descriptor. The default descriptor is TIP.
KEY DISABLE	Y or N	Select Y to disable this function.
UNDER MANAGER CONTROL	Y or N	Select Y if you do not want the operator to use this function in REGISTER MODE . When selected, the function is allowed only in the MANAGER MODE .
AMOUNT : Y / % : N	Y or N	Select 0 if the tip is to be a calculated percentage based on a percentage entry. Select 1 if the TIP is to be an amount entry.
ADD TAX RATE1 ADD TAX RATE2 ADD TAX RATE3 ADD TAX RATE4	Y or N	Choose Y to if tax is calculated and added on the tip amount.
TIP ADDED TO NET & GROSS	Y or N	Choose Y if you wish to add the TIP total to the NET and GROSS sales totals on the financial report.

VOID Key Program Notes

Option	Entry	Description
DESC	Alpha-numeric 18 character	You can program a unique descriptor. The default descriptor is VOID.
HALO	7-digit amount	You can limit errors by setting the maximum amount that can be tendered. "0" means that there is no entry limit.
KEY DISABLE	Y or N	Select Y to disable this function.
UNDER MANAGER CONTROL	Y or N	Select Y if you do not want the operator use of this function in REGISTER MODE . When selected, the function is allowed only in the MANAGER MODE .
COMPULSORY VALIDATION	Y or N	Choose Y to enforce validation if an optional printer with validation capability is connected to an RS-232C port.

WASTE Key Program Notes

Option	Entry	Description
DESC	Alpha-numeric 18 character	You can program a unique descriptor. The default descriptor is WASTE.
HALO	7-digit amount	You can limit errors by setting the maximum amount that can be used with this function. "0" means that there is no entry limit.
KEY DISABLE	Y or N	Select Y to disable this function.
UNDER MANAGER CONTROL	Y or N	Select Y if you do not want the operator use of this function in REGISTER MODE . When selected, the function is allowed only in the MANAGER MODE .
COMPULSORY VALIDATION	Y or N	Choose Y to enforce validation if an optional printer with validation capability is connected to an RS-232C port.

ALPHA TEXT Key Program Notes

Option	Entry	Description
DESC	Alpha-numeric 18 character	You can program a unique descriptor. The default descriptor is ALPHA TEXT.
PRINT ON KP	Y or N	Select Y to print text on Kitchen Printer.
PRINT ON RECEIPT	Y or N	Select Y to print text on register.
PRINT ON GUEST CHECKS	Y or N	Select Y to print text on Guest Check.
PRINT DOUBLE SIZE	Y or N	Select Y to print text with double size font.

AUTO CASH 1-8 Keys Program Notes

Option	Entry	Description
DESC	Alpha numeric 18 character	You can program a unique descriptor. The default descriptor is AUTO CASH1-8.
HALO	7-digit amount	You can limit errors by setting the maximum amount that can be used with this function. "0" means that there is no entry limit.

PRICE CHANGE Key Program Notes

Option	Entry	Description
DESC	Alpha- numeric 18 character	You can program a unique descriptor. The default descriptor is PRICE CHG.
PRICE CHANGE	NONE YES PROMPT	Choose N if you do not want to disable the function. Select YES if you want to save the price. Select PROMPT you can show message before save the new price.
KEY DISABLE	Y or N	Select Y to disable this function.
UNDER MANAGER CONTROL	Y or N	Select Y if you do not want the operator to use this function in REGISTER MODE . When selected, the function is allowed only in the MANAGER MODE .

VALIDATION Key Program Notes

Option	Entry	Description
DESC	Alpha- numeric 18 character	You can program a unique descriptor. The default descriptor is PRICE CHG.
SLIP OUTPUT PORT	0-2	If validation is used, identify the communications port (1-2) where the validating printer is attached. Enter 0 if validation is not used.
KEY DISABLE	Y or N	Select Y to disable this function.
ALLOW MULTIPLE RECEIPT	Y or N	Select Y to allow multiple validations of the same transaction.

Macro Key Programming

Macro keys may be programmed to perform up to 50 keystrokes. For example, a macro key could be set to tender (preset tender) a common currency, such as \$5 into the cash key. Use this program to record keystrokes for each of the 10 possible macro keys.

To Program a Macro

1. From the PROGRAM MODE, press **3** and **CASH** for FUNCTION KEY. The FUNCTION KEY PROGRAM screen displays:

```
FUNCTION KEY
1 . FUNCTION KEY
2 . MACRO KEY
```

2. From the **FUNCTION KEY** screen, press **2** and **CASH** for **MACRO**. The **MACRO PROGRAM** screen displays:

```
MACRO KEY
ENTER MACRO KEY
TO BE PROGRAMMED
```

3. Press the macro key (**MACRO1 – MACRO10**) that you wish to program. The screen displays Macro descriptor.

```
MACRO KEY
DESC :                               MACRO1
```

4. Type in a new descriptor if desired. Press the **CASH** key to proceed to the Macro key sequence programming. (*Pressing CLEAR will return to the Macro selection screen.*)
5. The screen displays the first macro line:

```
MACRO1
ENTER FUNC . KEY
1 :
[ HELP ] ENTER SAME MACRO KEY
TO FINISH PROGRAM
```

Key Lock Mode Information: The default mode is PGM mode. If you wish the macro to start in REG mode, first turn the key lock before recording keystrokes. You can turn the key lock again to another key position if necessary during the recording of the macro. You must return the key lock to the PGM mode to finalize the macro recording.

6. Press the first key of the macro sequence; continue entering all keystrokes. You can type up to 50 keystrokes including the Mode information.

```
MACRO1
ENTER FUNC . KEY
3 :                               CASH
```

7. Press the same **MACRO** key to end the sequence. You are returned to the Macro key selection screen.

8. Continue to program additional MACRO keys or press **CLEAR** key to return to **PROGRAM MODE** screen.

To Remove a Macro

If you wish to remove a key stroke from a macro, replace the current function with the 'INACTIVE' function. (*Function key code 458*)

NOTE:

PAGE↑, **PAGE**↓, ↑, ↓ keys are to move menu to menu in X, Z, P, S-Mode so the Macro Key must be assigned to different locations than these (**PAGE**↑, **PAGE**↓, ↑, ↓).

Options Programming

Options are organized into different categories, i.e. System, Print, Report, etc. to make it easier for the programmer to find and set options.

1. At the **PROGRAM MODE**, press **4** and **CASH** for **OPTIONS** Programming. The **OPTIONS** screen displays:

```
          OPTIONS
1 . SYSTEM          ←
2 . PRINT
3 . REPORT
4 . TAX
5 . CURRENCY
6 . ROUNDING
```

2. Press the **↑** key and the **↓** key to select menu and press the **CASH** key to confirm. You can also select menu by **page ↑** key and **page ↓** key.

```
          OPTIONS
7 . LOGO           ←
8 . KITCHEN PRN
9 . BARCODE
10 . EJ
11 . TRAIN MODE
12 . TABLE
```

```
          OPTIONS
13 .DETAIL PRINT
```

3. Select **PRINT** programming. The **PRINT** screen display:

```
          PRINT
1 . PRINT DATE      [Y]
2 . PRINT TIME      [Y]
3 . PRINT MACHINE NO [Y]
4 . PRINT CLERK NAME [Y]
5 . PRINT CONSECUTIVENO [Y]
6 . PRINT SALE ITEM NO [N]
```

4. Press the **↑** key and the **↓** key to select option and press the **CASH** key to confirm. You can also select option by **page ↑** key and **page ↓** key.
5. Select **PRINT DATE** option.

```
          PRINT
PRINT DATE          Y
SELECT : UP, DOWN
CHANGE : CASH
CANCEL : CLEAR
```

6. Press the **↑** key for **YES** and the **↓** key for **NO**.
Press the **CASH** to confirm the option value and return option screen.

SYSTEM Options

System Option	Entry	Description
1. BEEPER ACTIVE	Y or N	Select N for a silent keyboard.
2. CLERK ENTRY	PUSH CODE	Select PUSH for a push button clerk, select CODE for a code entry clerk system (number - clerk or clerk - number - clerk) sequence.
3. CLERK IS	STAY DOWN POP-UP	Select Y for pop-up clerks, select N for stay down clerks. With pop-up clerks, you must sign on for each transaction. With stay down clerks, the same clerk remains signed on until sign off.
4. CLERK INTERRUPT	Y or N	If allowed, a new clerk can be signed on in the middle of a transaction. In this circumstance, the initial transaction is suspended. When the interrupt transaction is completed, the suspended transaction can be continued.
5. DECIMAL PLACE	0-3	Enter a digit to place the decimal point the selected number of positions from the right.
6. DATE FORMAT IS	MMDDYY DDMMYY YYMMDD	Select date printing format.
7. DESC. PGM METHOD	OVERLAY CODE	When OVERLAY TYPE, program descriptors by pressing the appropriate key on the program overlay. When CODE TYPE, program descriptors by typing the code for each descriptor character.
8. DRAWER MUST BE SHUT TO SALE	Y or N	Select Y to enforce closed drawer for register operations.
9. ACTIVATE OPEN DRAWER ALARM	Y or N	Select Y if you want the error tone to automatically sound when the drawer stays open longer than the time set in the following field.
10. DRAWER OPEN TIME	0-99	If you enable the open drawer alarm above, you can set the length of time (1-99 seconds) before the alarm sounds.
11. ALLOW POST TENDER	Y or N	Select Y to allow re-tendering should a second change calculation be necessary. Re-enter the tendered amount and press the CASH key to show the new change computation.
12. OPEN DRAWER ON POST TENDER	Y or N	If you enable post tendering, select N to not open the cash drawer after the second tender.
13. GLOBAL ENTRY LIMIT	0-14	Enter a digit to determine the number of numeric digits that can be entered for any register function. Enter 0 for no limit.
14. ALLOW MULPTIPLE RECEIPT	Y or N	Set to Y if you wish to issue more than one copy of a transaction receipt.
15. DEACTIVATE SPLIT PRICING	Y or N	If N, both multiplication and split pricing calculations can be done with the X/TIME key. If Y, only multiplication can be done with the X/TIME key.
16. ALLOW DIRECT MULTIPLY	Y or N	If Y, you can multiply preset items by simply entering the quantity, then pressing the preset PLU key.

System Option	Entry	Description
17. DIRECT MULTIPLY OVER ONE DIGIT	Y or N	If you allow direct multiplication of a preset PLU, you can allow only single digit multiplication or multiplication by more than one digit.
18. TRIPLE MULTIPLICATION	Y or N	YES allows multiple multiplication, for example, 2 X/TIME, 3 X/TIME, ITEM. Note that multiple multiplication overrides split pricing.
19. DISPLAY ADD PRICE OF LINKED ITEMS	Y or N	When Y, the customer display shows a total of the item and linked item. For example, if PLU is \$1.00 and is linked to PLU2 which is \$0.25, the customer display will show \$1.25.
20. PROMPT FOR PRICE IF PRICE=0.00	Y or N	Select Y to allow the operator to enter PLU price of zero price.
21. COMPULSORY SUBT.BEFORE TENDER	Y or N	Select Y if you want to force the operator to use the SUBTOTAL function before tendering.
22. ENABLE NOT FOUND PLU	Y or N	Select Y to allow the operator to enter PLU prices and other data when the entered PLU number is not found in the PLU file.
23. NEGATIVE SALE MGR ONLY	Y or N	Select Y if you wish to control negative transactions (when cash is removed from the drawer). When selected mode position must be in the Manager mode to finalize the transaction.
24. ZERO SALE MGR ONLY	Y or N	Select Y if you wish to control zero transactions (when cash is removed from the drawer). When selected mode position must be in the Manager mode to finalize the transaction.
25. MODIFIER:	POP-UP ITEM POP-UP SALE STAY DOWN	A MODIFIER key alters the next PLU registered, either by changing the code number of the PLU so that a different item is registered, or by adding the modifier descriptor and not changing the code of the subsequent PLU. If you press a modifier key, you have the option of the modifier applying only to the next item (0), having the same modifier apply to any subsequent item registered in the same transaction (1), or having the same modifier apply to any subsequent item on any subsequent transaction (2).
26. PRICE LEVEL IS	POP-UP ITEM POP-UP SALE STAY DOWN	If you press a price level key, you have the option of the level key applying only to the next item (0), having the same level key apply to any subsequent item registered in the same transaction (1), or having the same level key apply to any subsequent item on any subsequent transaction (2).
27. KEYBOARD SHIFT	POP-UP ITEM POP-UP SALE STAY DOWN	If you press a keyboard shift key, you have the option of the keyboard level key applying only to the next item (0), having the same level key apply to any subsequent item registered in the same transaction (1), or having the same level key apply to any subsequent item on any subsequent transaction (2).

System Option	Entry	Description
28. HASH IS	NORMAL NON-ADD	NORMAL: Hash adds to all totals except the gross and net sales totals on the financial report. NON-ADD: Hash does not add to any totals, except the HASH total on the financial report.
29. % IS NOT AFFECT TO NET SALE	Y or N	Select Y not to affect net sale amount.
30. TENDER VALID AMOUNT	AMT OF SALE AMT TENDERED	Validation is allowed if an appropriate optional printer is connected to an RS-232C port. Here you can choose the content of single line validation
31. DISABLE CASH DECLARATION	Y or N	Select Y to block the cash declaration function.
32. ALLOW SALE WITH ZERO STOCK	Y or N	When N, inventory PLU's cannot be sold when stock reaches "0".
33. WARNING BELOW MINIMUM STOCK	Y or N	Select Y to display warning message if current stock value is less than minimum stock value.
34. STOCK PROGRAM BY PC/SD/USB	ADD(+) SUB(-) REPLACE	Choose ADD(+), SUB(-) or REPLACE to determine whether the quantity of inventory you enter in the PLU stock program adds to existing inventory quantity, or whether it replaces the current inventory quantity.
35. USE X/Z/P/S-MODE PASSWORD	Y or N	Select Y to be password protected to provide management restriction in X, Z, PROGRAM(P) and SERVICE(S) MODE.
36. PRINTER PAPER SENSOR ACTIVE	Y or N	A built-in paper sensor determines whether paper is currently loaded in the printer. If Y, operations are not allowed without paper loaded. If N, operations are allowed when paper is out.
37. RS-232C PORT POWER ON	Y or N	Select Y to turn ON the RS-232C port power.
38. DISPLAY 4 LINE IN REGISTER MODE	Y or N	Select Y to display 4 items or N to display 1 item in Register mode. (Graphic Multi-line LCD only)
39. STORE NAME	8 Character	Stored files will be saved on SD/USB under a folder with the store name. Do not include spaces between the name.
40. DRAWER LIMIT	8 DIGITS	You can set a limit for the drawer total. When cash in drawer exceeds the limit you program here, a warning will display on the screen. You must press CLEAR to remove the warning and continue operations. The warning will continue to appear at the completion of every transaction with the limit exceeded, until you use the PAID OUT function to remove cash from the drawer. Set the drawer limit to 0 to disable the drawer limit warning.
41. CHECK CHANGE LIMIT	8 DIGITS	Use this program to set the maximum amount of cash that can be returned when a check is tendered for an amount greater than the amount of the sale. For example, if the check change limit is \$10.00 the maximum amount that can be tendered into the check key on a \$5.00 sale is \$15.00.

System Option	Entry	Description
42. TARE WEIGHT TARE 1 : TARE 2 : TARE 3 : TARE 4 : TARE 5 :	4 DIGITS	A tare is the amount of weight representing the container, or package when items are sold by weight. You can pre-program five tare weights, representing the weight of different containers. When you place an item and a container on an optional scale, you can enter the tare number to automatically subtract the pre-programmed tare weight. If you choose to use tare #5 for manual tare weight entry, do not enter a weight for tare #5.
43. MACHINE NO.	5 DIGITS	The machine number is printed on the register receipt. Program a machine number so that any receipt can be identified with the store or register where the transaction took place.
44. MODE P/W	6 DIGITS	If you wish to use mode password, you must program a password that you will use to enter X mode, Z-Mode, PROGRAM(P) mode and SERVICE(S) mode. The password may be up to 6 digits.
45. LANGUAGE SELECT	ENGLISH SPANISH GERMAN	Descriptors of menu, system and option can be converted to the selected language automatically. But Descriptors of Report, PLU, Group and etc. cannot be converted to the selected language. Those descriptors can be changed only by user programming.
46. USE RECEIPT AS DEATIL	Y or N	Select Y if you wish to print sale receipt as detail printer format (journal printer). If Y, you can program some options of DETAIL PRINT option.
47. NOT INCREASE RCPT# AT CLK IN/OUT	Y or N	Select Y if you do not wish to increase a receipt number when signing on or off a clerk.
48. EFT DRAFT	DATATRAN FINE DINNING	Select Fine Dining to print a tip line on EFT draft. Select Datatran to not print tip line.
49. MSR CONNECT	DATATRAN PDC	Select if the card reader is connected to the Datatran or the PDC.
50. PIN PAD TYPE	DUKPT ROTATE	Always select DUKPT
51. PIN PAD PORT	0-3	Select the port number where Pin-Pad is connected.
52. COPY OF DATATRAN RECEIPT	0-99	Set the desired number of EFT receipts to print (default = 1)
53. MARK CARD No ON ALL EFT DRAFT	Y or N	Set to N to NOT print card number on EFT receipts.
54. "test" CLERK ID?	Y or N	Always set to N
55. CARDHOLDER NAME?	Y or N	Set to Y if you want the cardholder's name printed on EFT receipts.

PRINT Options

Print Option	Entry	Description
1. PRINT DATE	Y or N	Select N if you wish to delete the printing of the date.
2. PRINT TIME	Y or N	Select N if you wish to delete the printing of the time.
3. PRINT MACHINE NO.	Y or N	If you are using more than one cash register, you can identify the specific register where a receipt was printed. Enter Y if you wish to print the register number on the receipt.
4. PRINT CLERK NAME	Y or N	Select N if you wish to delete the printing of the clerk name on the receipt.
5. PRINT CONSECUTIVE NO.	Y or N	The consecutive number (also referred to as the transaction counter, or receipt counter) normally prints on each receipt. Select N if you do not wish to print this counter.
6. PRINT SALE ITEM No	Y or N	Select Y if you wish to print a count of the number of items on each receipt.
7. PRINT PLU # ON RECEIPT	Y or N	If Y , the PLU number and descriptor will print. If N , only the PLU number will print.
8. USE THOUSAND SEPARATOR	Y or N	Select Y if you wish to use Thousandths Separator.
9. SEPARATOR TYPE	, SPACE .	Choose the thousandths separator: Comma (,) (space) or decimal (.)
10. PRINT RECEIPT WHEN SIGN ON/OFF	Y or N	Select N if you do not wish to print a receipt when signing on or off a clerk.
11. ALLOW SECOND RECEIPT	Y or N	Set to Y if you wish to issue only one copy of a transaction receipt.
12. PRINT SUBTOTAL WHEN PRESSED	Y or N	Select Y if you wish the subtotal to print when the SUBTOTAL key is pressed.
13. PRINT SUBTOTAL WITHOUT TAX	Y or N	If you hand-write credit card slips, you may find it useful to print the merchandise subtotal. Select Y if you wish to print the subtotal without tax on the receipt.
14. PRT GROUP TOTAL AFTER TENDER	Y or N	Choose Y if you wish to print group total after tender.
15. VOLUME UNIT	GAL LTR	If gallonage is selected in PLU programming, choose gallons or liters here.
16. SURPRESS BITMAP IN PGM/X/Z	Y or N	Select Y if you do not wish to print Image logo in Program, X and Z-Modes.
17. PRE-FEED LINE# RECEIPT (0-5)	0-5	Enter the number of lines you wish to feed before beginning receipt printer print.
18. POST-FEED LINE# RECEIPT (0-5)	0-5	Enter the number of lines you wish to feed after beginning receipt printer print.

Print Option	Entry	Description
19. PRT DOUBLE HIGH ALL TOTAL AMT	Y or N	Select Y if you wish to print total amount as double size on the receipt.
20. CURRENCY LOGO: HOME CURRENCY CONV#1 LOGO CONV#2 LOGO CONV#3 LOGO CONV#4 LOGO	5 Character	Users can designate a different home currency symbol. To select a different home currency symbol, press the symbol you wish to use on the Alpha Keyboard Overlay. If you are using the currency conversion feature, you can select the appropriate symbol for each foreign currency you are accepting. To select a different symbol, press the symbol you wish to use on the Alpha Keyboard Overlay.
21. SCAN PLU NAME & PRICE	Y or N	Select Y if you wish to scan only PLU name and price.
22. BOLD DESC. FOR TOTAL/PAYMENT	Y or N	Select Y if you wish to print total descriptor and payment (CASH, CHECK, and MISC TEND) descriptor as double size on the receipt.
23. PRINT QUANTITY ON RECEIPT	Y or N	Select Y if you wish to print quantity of each item on the receipt.
24. USE TAXABLE DESC.OF FIN ON RCPT	Y or N	Select Y if you wish to use taxable descriptor of financial on the receipt.

REPORT Options

Report Option	Entry	Description
1. CASH DECLARATION REQ BEFORE REPORTS	Y or N	Select Y to enforce a cash declaration function before a financial, clerk, or cash in drawer report can be generated.
2. ONLY ONE X RPT BEF. CASH DECL	Y or N	Select Y to allow X report only one time before Cash Declaration.
3. DISABLE X REPORT	Y or N	Select Y to disable X reports.
4. OPEN DRAWER WHEN REPORTS RUN	Y or N	Select N to stop the drawer from opening when reports are run.
5. SURPRESS PRT OF LAST REPT DATE	Y or N	Select Y if you do not want to print last issued date on report.
6. RESET RECEIPT No AFTER Z REPORT	Y or N	Select Y if you wish to reset the transaction number (often called the receipt counter) to zero after the financial report is reset.
7. RESET GRAND TOTAL AFTER Z REPORT	Y or N	Select Y if you wish to reset the grand total to zero after the financial report is reset.
8. RESET Z COUNTER AFTER Z1 FINANCIAL REPORT	Y or N	Choose Y or N to determine if you wish to reset the Z counter after a Z1 financial report.
9. RESET Z COUNTER AFTER Z1 TIME REPORT	Y or N	Choose Y or N to determine if you wish to reset the Z counter after a Z1 time report.

Report Option	Entry	Description
10. RESET Z COUNTER AFTER Z1 PLU REPORT	Y or N	Choose Y or N to determine if you wish to reset the Z counter after a Z1 PLU report.
11. RESET Z COUNTER AFTER Z1 CLERK REPORT	Y or N	Choose Y or N to determine if you wish to reset the Z counter after a Z1 clerk report.
12. RESET Z COUNTER AFTER Z1 GROUP REPORT	Y or N	Choose Y or N to determine if you wish to reset the Z counter after a Z1 group report.
13. RESET Z COUNTER AFTER Z2 DAILY RPT	Y or N	Choose Y or N to determine if you wish to reset the Z counter after a Z2 of the daily sales report.
14. RESET ORDER No. AFTER Z1 REPORT	Y or N	Choose Y or N to determine if you wish to reset the Order number after a Z1 of the financial report.
15. PRINT Z COUNTER ON REPORT	Y or N	Select N if you wish to delete the printing of the reset counter on Z reports.
16. SKIP ZERO TOTALS ON FINANCIAL REPORT	Y or N	By default, the register prints only totals with information other than zero. Select N , if you wish to print the contents of all the financial report totals, even if the total is zero.
17. PRINT NEGATIVE ITEM ON REPORT	Y or N	Select N to remove the VOID MODE, RETURN, ERROR CORR and VOID totals from the financial and clerk reports.
18. PRINT AUDACTION ON FINANCIAL REPORT	Y or N	Select N to remove the AUDACTION total from the financial and clerk reports.
19. PRINT ON FIN RPT AVG ITEM/CUST	Y or N	Select Y to print the average items per customer (PLU sales counter/Net sales counter).
20. PRINT ON FIN RPT AVG \$/CUST	Y or N	Select Y to print the average sales per customer (Net Sales/Net Sales counter).
21. PRINT CLERK REPORT AFTER FINANCIAL REPORT	Y or N	Select Y if you wish to include the clerk report information at the end of the financial report.
22. PRINT DOUBLE FINANCIAL REPORT	Y or N	Select Y if you wish to print 2 copy financial reports.
23. PRINT GROSS TOTAL ON X REPORT	Y or N	Select N if you wish to delete the printing of the gross sales total on the X financial report.
24. PRINT GROSS TOTAL ON Z REPORT	Y or N	Select N if you wish to delete the printing of the gross sales total on the Z financial report.
25. PRINT GRAND TOTAL ON X REPORT	Y or N	Select N if you wish to delete the printing of the grand total on the X financial report.
26. PRINT GRAND TOTAL ON Z REPORT	Y or N	Select N if you wish to delete the printing of the grand total on the Z financial report.
27. GRAND TOTAL IS	GROSS NET	Choose GROSS if you wish the grand total to accumulate daily gross sales totals. Choose NET if you wish the grand total to accumulate daily net sales totals.

Report Option	Entry	Description
28. SKIP ZERO TOTALS ON CLERK REPORT	Y or N	By default, the register prints only totals with information other than zero. Select N , if you wish to print the contents of all the clerk report totals, even if the total is zero.
29. PRINT MEDIA TOTALS ON CLERK REPORT	Y or N	Select Y to print media totals for each clerk, thus allowing clerk cash drawer accountability.
30. SKIP ZERO TOTALS ON PLU REPORT	Y or N	By default, the register prints only totals with information other than zero. Select Y , if you wish to print the contents of all the PLU's, even if the total is zero.
31. PRINT PLU # ON PLU REPORT	Y or N	Determines whether PLU# is displayed on the report.
32. PRINT % OF SALES ON PLU REPORT	Y or N	The register can calculate the percentage of sales represented by each PLU. Select Y if you wish to print this percentage on the PLU report. Note: the percentage will print only on standalone register reports, not IRC report.
33. PRT PLU BY PRICE LEVEL REPORT	Y or N	Select Y if you wish to print PLU by price level on PLU reports.
34. ALLOW Z STOCK REPORT	Y or N	When N , the operator is not allowed to clear (Z) stock.
35. PRINT WHEN POLLING REPORTS	Y or N	Choose N if you would like to suppress register printing when reports are polled.
36. PRINT TRAIN TOTAL IN FINANCIAL REPORT	Y or N	Select Y if you wish to print train total on Financial Report.
37. PRINT VAT BREAKDOWN ON FINANCIAL REPORT	Y or N	If Y , a breakdown of the VAT eligible sale (the net amount) will print on Financial Report.
38. PRINT VAT BREAKDOWN ON CLERK REPORT	Y or N	If Y , a breakdown of the VAT eligible sale (the net amount) will print on Clerk Report.
39. PRINT GROUP ON FINANCIAL REPORT	Y or N	Select Y if you wish to print the group report on financial report. If Y , the group report will not be issued alone.

TAX Options

Tax Option	Entry	Description
1. PRINT TAX SYMBOL	Y or N	Select N to remove the tax symbol (i.e."T1") from the print and display.
2. PRINT TAX AMOUNT	Y or N	Select Y if you wish to delete the printing of the tax amount on the receipt.
3. PRINT TAXABLE TOTAL	Y or N	Select Y if you wish to print the total of merchandise eligible for each tax on the receipt.

Tax Option	Entry	Description
4. PRINT TAX RATE	Y or N	If you are calculating a tax percentage (add-on or VAT), select Y if you wish to print the tax rate on each receipt.
5. PRINT VAT BREAKDOWN	Y or N	If Y, a breakdown of the VAT eligible sale will print, the net amount and the VAT amount.
6. TAX AMOUNT IS	ITEM COMBINE	Select COMBINE if you are calculating and reporting more than one sales tax rate separately and you wish to print just the total of multiple taxes rather than itemize each tax on the receipt.

CURRENCY Options

Currency Option	Entry	Description
1. BASE CURRENCY	HOME EURO	Choose base currency Home or Euro.

ROUNDING Options

Rounding Option	Entry	Description
1. ROUND TABLE TYPE	ROUND TABLE SWEDISH CANADIAN	Select ROUND TABLE, SWEDISH or CANADIAN to implement the rounding system that you enter on this option.
2. ROUND TABLE	2 DIGITS	If you wish to use Round Table system, you must program a Rounding table. The SWEDISH/CANADIAN rounding table is as below. # START END VALUE 1 .00 .02 .00 2 .03 .07 .05 3 .08 .09 .10
3. ALLOW ROUND ON SUBT	Y or N	Select Y you wish to allow rounding when press SUBTOTAL key.
4. ALLOW ROUND ON CASH	Y or N	Select Y you wish to allow rounding when press CASH key.
5. % AND TAX ROUNDING	ROUND UP 0.005, ROUND UP, ROUND DOWN	Select the digit that represents the appropriate rounding method for tax and discount calculations.
6. SPLIT PRICE ROUNDING	ROUND UP 0.005, ROUND UP, ROUND DOWN	Select the digit that represents the appropriate rounding method for split pricing (i.e. 2 at 3 for \$1.00) calculations.

LOGO Options

Logo Option	Entry	Description
1. PRINT PREAMBLE MESSAGE IN RCPT	Y or N	Choose whether to print the PREAMBLE on the receipt.
2. PRINT POSTAMBLE MESSAGE IN RCPT	Y or N	Choose whether to print the POSTAMBLE on the receipt.
3. PRINT PREAMBLE MESSAGE IN GUEST	Y or N	Choose whether to print the PREAMBLE on the guest check.
4. PRINT POSTAMBLE MESSAGE IN GUEST	Y or N	Choose whether to print the POSTAMBLE on the guest check.
5. PRINT PREAMBLE IMG IN RCPT	Y or N	Choose whether to print the PRE-GRAPHIC LOGO on the receipt.
6. PRINT POSTAMBLE IMG IN RCPT	Y or N	Choose whether to print the POST-GRAPHIC LOGO on the receipt.
7. PRINT PREAMBLE IMG IN GUEST	Y or N	Choose whether to print the PRE-GRAPHIC LOGO on the guest check.
8. PRINT POSTAMBLE IMG IN GUEST	Y or N	Choose whether to print the POST-GRAPHIC LOGO on the guest check.
9. PREAMBLE IMAGE NO. ON RCPT	0-20	Choose pre- image no to print on the receipt.
10. POSTAMBLE IMAGE NO. ON RCPT	0-20	Choose post-image no to print on the receipt.
11. PREAMBLE IMAGE NO. ON GUEST	0-20	Choose pre- image no to print on the guest check.
12. POSTAMBLE IMAGE NO. ON GUEST	0-20	Choose post-image no to print on the guest check.
13. PRINT PRE MESSAGE ON ORDER IN RCPT	Y or N	Choose whether to print the PREAMBLE on the internal order receipt.
14. PRINT PRE IMG ON ORDER IN RCPT	Y or N	Choose whether to print the PREAMBLE LOGO on the internal order receipt.

KITCHEN PRINTER Options

Kitchen Printer Option	Entry	Description
15. PRINT KP ORDER # ON RECEIPT	Y or N	A system wide counter creates an order number for each kitchen requisition. Choose Y or N to print the order number on the kitchen printer requisition.
16. PRINT PRICE ON KP	Y or N	You can choose to print the item with or without its' price on the kitchen requisition.
17. SEND TO KP IN VOID MODE	Y or N	You can choose whether to print or not print registrations in void mode on kitchen requisitions.
18. SEND ORDER TO KP AT SUBTOTAL	Y or N	Choose Y to print orders on the KP when the SUBTOTAL key is pressed. Choose N to print orders on the KP when the order is finalized.

Kitchen Printer Option	Entry	Description
19. COMBINE LIKE ITEMS ON KP	Y or N	If two of the same items are registered in the same transaction, you can choose the format on the kitchen requisition. For example, if Y, "2 HAMBURGERS; if N, "1 HAMBURGER" and "1 HAMBURGER".
20. PRIORITY PRINT BY GROUP ON KP	Y or N	If Y , the order in which items appear on a kitchen requisition is determined by the group to which the item is assigned, i.e. items reported to group 1 will print before items reported to group 2.
21. PRT GROUP DETAIL ON KP	Y or N	Select Y to print Group detail on the order receipt.
22. TWO LINE PRINT ON KP	Y or N	Choose Y to print two lines on Kitchen printer.
23. PRINT PLU NUMBER ON KP	Y or N	Select Y to print PLU number on the order receipt.
24. PRINT TOTAL AMT OF PLU ON KP	Y or N	Select Y to print total amount of PLU on kitchen printer.
25. KP START NO.	6 DIGITS	If you wish to modify, the KP start number can be programed up to 6 digits.

BARCODE Options

Barcode Option	Entry	Description
1. BARCODE TYPE	NONE PRICE WEIGHT	Select bar code type.
2. LENGTH OF FIELD1 PLU CODE	4-6	Select length of PLU code.
3. LENGTH OF PRICE OR WEIGHT	4-6	Select length of price or weight.
4. DECIMAL NUM. FOR WEIGHT	0-3	Select decimal number of weight.
5. BAR WEIGHT TYPE	LB KG OZ	Choose weight type.

EJ Options

EJ Option	Entry	Description
1. ELECTRONIC JOURNAL ENABLE	Y or N	Select Y to enable the electronic journal. The electronic journal captures in memory what you would print line by line on a traditional journal. The four options that follow control the electronic journal feature. The electronic journal can be printed in the REPORT MODE reset in the Z-MODE .

EJ Option	Entry	Description
2. PROMPT WHEN E.J. BUFFER IS FULL	Y or N	If the electronic journal is enabled above, select Y if you wish to display a message to notify the operator when the journal memory is full.
3. STOP OPERATIONS WHEN E.J. BUFFER IS FULL	Y or N	If the electronic journal is enabled above, select Y if you wish to stop operations when the journal memory is full.
4. SEND ONLY NEGATIVE ENTRIES TO E.J.	Y or N	If the electronic journal is enabled above, select Y if you wish to capture only transactions with negative entries.
5. SEND RESET REPORT TO E.J.	Y or N	If the electronic journal is enabled above, select Y if you wish to capture reset reports.
6. E.J. PRINTING 7.	NEW OLD	NEW: Prints electronic journal from lowest consecutive number to highest. OLD: Prints electronic journal from highest consecutive number to lowest.
8. E.J. PORT	0-2	Choose a port for a remote printer to print electronic journal reports instead of the register printer.
9. PRINT SMALL FONT EJ REPORT	Y or N	Select Y to print small font on EJ report.
10. SAVE EJ TO SD	NONE EVERY TIME ONCE AFTER Z REPORT	Store electronic journal data to the sd card. Select "EVERY TIME" to store at every sale. Select "Once after z report" to store only after z report. If you don't want to store electronic journal data to the SD card, select "NONE".

TRAIN MODE Options

Train Mode Option	Entry	Description
1. OPEN DRAWER IN TRAIN MODE	Y or N	Select N if you do not want the cash drawer to open during training mode operations.
2. PRINT TRAIN MODE TITLE	Y or N	When in training mode, the message "TRAIN MODE" normally prints on each receipt. Select N if you wish to delete this message.
3. SEND TO KP IN 4. TRAIN MODE	Y or N	You can choose whether to print or not print registrations in training mode on kitchen requisitions.
5. PRINT JOURNAL IN TRAIN MODE	Y or N	Select Y to print on the detail printer in train mode.
6. TRAIN P/W	6 DIGITS	If you wish to use training mode, you must program a password that you will use to enter training mode. The password may be up to 6 digits.
7. PRT TRAIN CLERK START/END MESSAGE	Y or N	Select N if you do not wish to print a message of train clerk start or end.

TABLE Options

Table Option	Entry	Description
1. REQ X MODE TO OPEN/CLOSE CHECK	Y or N	Select Y , if you wish to open new checks or to close checks only in X mode.
2. CONSOLIDATION ON CHECK TRACK	Y or N	Consolidation of like items can be selected for soft guest check printing. For example, if three rounds of drinks are served, the check will print "3 TAP BEER" rather than "1 TAP BEER" three times.
3. PRINT VOID AND RETURN ON CHECK BILL	Y or N	Select Y to print Void and Return on Check.
4. PRINT GUEST CHECK AT FINALIZED	Y or N	Select Y to print guest check at finalized.
5. PRINT DATE ON SERV(HARD CHK)	Y or N	Select Y to print date on service receipt.
6. SUPPRESS NEW BALANCE RECEIPT	Y or N	Select Y to print new balance receipt.
7. PRINT TABLE SERVICE IN REPORT	Y or N	Select Y to print table service in financial report.
8. COMPULSORY EAT-IN, TAKE OUT, DRIVE THRU BEFORE TENDER	Y or N	Choose Y if you wish to enforce use of one of the destination keys (EAT-IN, TAKE OUT, or DRIVE THRU) before the sale is finalized.

DETAIL PRINT Options

Detail Option	Entry	Description
1. JOURNAL IS OFF	Y or N	Select Y to disable Detail printer.
2. CONDENSE JOURNAL PRINT	Y or N	Select Y to print small font on detail printer.
3. NOT PRINT MSG ON JOURNAL	Y or N	Select Y if you do not wish to print message on detail receipt.
4. SPOOL USE	Y or N	Select N to disable spool.
5. PRINT PREAMBLE IMG ON JOURNAL	Y or N	Choose whether to print the PRE-GRAPHIC LOGO on detail receipt.
6. PRINT POSTAMBLE IMG ON JOURNAL	Y or N	Choose whether to print the POST-GRAPHIC LOGO on detail receipt.

Employee Programming

- At the **PROGRAM MODE** menu, press **5** and **CASH** for **EMPLOYEE**. The **CLERK NUMBER** screen displays:

EMPLOYEE
ENTER CLERK #
(1 - 1 0) 0

- Press the clerk number and **CASH**.
- Press the **↑** key and the **↓** key to select menu and press the **CASH** key to confirm. You can also select menu by **page ↑** key and **page ↓** key. Select the Employee option you wish to program.
- Press the **↑** key for YES and the **↓** key for NO. Press the **CASH** to confirm the option value and return previous screen.
- Press the **CLEAR** key to finalize and return to the **ENTER CLERK#** screen.

Clerk Programming - Reference Information

Option	Entry	Description
1. NAME	Alpha-numeric 16 character	You can program a descriptor for each clerk. The name you program will print on the receipt in place of the default CLERK #1-99. Type the descriptor using the descriptor code method (<i>see page 120</i>) or use the Alpha Keyboard Overlay. The overlay is automatically activated when the cursor is pointing at the DESC field.
2. PASSWORD	6-digit number	If you are using a direct or code entry clerk system. The number you set here is the number you must use to sign on or clock in/out. If using an optional card reader, you must swipe the employee card at this field.
3. TRAIN CLERK	Y or N	Set to Y if you wish to be train clerk.
4. ALLOW X REPORTS	Y or N	If Y , you can use X Reports menu.
5. ALLOW Z MODE	Y or N	If Y , you can use Z-Mode.
6. ALLOW P MODE	Y or N	If Y , you can use P mode.
7. ALLOW S MODE	Y or N	If Y , you can use S-Mode.
8. ALLOW VOID MODE	Y or N	If Y , you can use VOID mode.

Time

Time & Date

Use this program to set the clock and calendar on your HK-7200 Series. The date changes automatically. After initial setting, time changing will probably be required only for beginning and ending daylight savings time.

1. From the **PROGRAM MODE** menu, press **6** and **CASH** for **TIME**. Press **1** and **CASH** for **TIME & DATE**. The **TIME & DATE** screen displays:

```
TIME & DATE
TIME :           HH:MM
( 24:00 )       16:42
```

2. Type the current time in 24-hour format (i.e. military time, where 13:00 is 1:00 PM.) Press the **CASH**.
3. Type the current date in MM (month) DD (day) and YY (year) format. Press the **CASH**.

Time Schedule

Certain functions can be set to automatically initiate at a specified time and date. When the time setting ends, the register will revert to the default. Time schedule functions include:

- Price Level 2: To accommodate 'Happy Hour' pricing for example.
- Keyboard Shift 1-3: You may have different keyboards for 'Breakfast, Lunch, Dinner'.
- Program Backup to SD: To automatically back up the program files at the specified time & date. This is useful when program changes are made frequently.
- Report Backup to SD: To automatically back up the X Report data at the specified time & date. This report information can then be loaded into the eSpreso PC Utility for easy viewing.

Each time schedule function has the same programming options; To schedule these functions:

1. From the **PROGRAM MODE** menu, press **6** and **CASH** for **TIME**. Press **2** and **CASH** for **TIME SCHEDULE**. The **TIME SCHEDULE** screen displays:

```
TIME SCHEDULE
1.PRICE LEVEL2           ←
2.KBD SHIFT1
3.KBD SHIFT2
4.KBD SHIFT3
5.SD PGM BACKUP
6.SD REP BACKUP
-PAGE 1/1-
```

2. Select a time schedule function from the menu to program. For example, if you press **1** and **CASH** for PRICE LEVEL2. Time schedule program screen displays:

```
PRICE LEVEL2
1 . START TIME      [ 99 : 99 ]
2 . END TIME        [ 99 . 99 ]
3 . SUN              [ N ]
4 . MON              [ N ]
5 . TUE              [ N ]
6 . WED              [ N ]
-PAGE 1 / 2-
```

3. Press the **↑** key and the **↓** key to select menu and press the **CASH** key to confirm. You can also select menu by **page↑** key and **page↓** key.
4. From the YES/NO type option screen, Press the **↑** key for YES and the **↓** key for NO. Press the **CASH** to confirm the option value.
5. To exit the current Time Schedule program, press the **CLEAR** key.
6. Continue programming additional Time Schedules as desired, press **CLEAR** to return to the Program Mode.

Taxes Programming

The HK-7200 Series allows three calculation options for each of the four possible taxes.

- **Add-On** - most sales taxes can be programmed by entering an *add-on* tax percentage rate.
- **VAT** - if tax is included in the cost of the item, you can use value added tax (VAT) to calculate the tax share of each sale.
- **GST** - for the Canadian Goods and Services tax (GST) can be set using tax rate 4.

Important Note: After you have entered your tax program, test for accuracy by entering several transactions of different dollar amounts. Carefully check to make sure the tax charged by the cash register matches the tax amounts on the printed tax chart for your area. As a merchant, you are responsible for accurate tax collection. If the cash register is not calculating tax accurately, or if you cannot program your tax properly from the information in this manual, contact your Dealer for assistance.

Programming an Add-On Tax Rate Percentage

When tax requirements can be met using a straight percentage rate, use the following method to program a tax as a straight percentage.

1. Move to the **PROGRAM MODE**.
2. From the **PROGRAM MODE** menu, press **7** and **CASH** to view the TAXES screen:

TAXES	
ENTER TAX#	0
(1 - 4)	

3. Enter the Tax number and press the **CASH** key to confirm.

TAXES	
1 . DESC :	[TAX1]
2 . TYPE	[ADD - ON]
3 . RATE	[0 . 0 0 0]

4. At the TYPE field, press the ↑ key and the ↓ key to select the ADD-ON and press the **CASH** key to confirm.
5. At the RATE field, input the tax rate and press the **CASH** key to confirm.
6. Enter the percentage rate for the sales tax. For example, if the tax is 6 percent, enter 6000. Press **CASH** to set the rate.
7. Continue to program additional taxes or press **CLEAR** to return to the **PROGRAM MODE** screen.

Programming a VAT Tax (Value Added Tax)

1. When a tax is included in the cost of the item, you can use the value added tax (VAT) program to calculate the tax share of each sale.
2. Move to the **PROGRAM MODE**.
3. From the **PROGRAM MODE** menu, press **7** and **CASH** to view the TAXES screen:

```
TAXES
ENTER TAX #
( 1 - 4 )                                0
```

4. Enter the Tax number and press the **CASH** key to confirm.

```
TAXES
1 . DESC :                               [ TAX2 ]
2 . TYPE                               [ VAT ]
3 . RATE                               [ 0 . 0 0 0 ]
```

5. At the TYPE field, press the ↑ key and the ↓ key to select VAT and press the **CASH** key to confirm.
6. At the RATE field, input the tax rate and press the **CASH** key to confirm.
7. Enter the percentage rate for the sales tax. For example, if the tax is 6 percent, enter 6000. Press **CASH** to set the rate.
8. Continue to program additional taxes or press **CLEAR** to return to the **PROGRAM MODE** screen.

Programming Canadian GST

1. Tax 4 can be programmed to accommodate the Canadian Goods and Services tax (GST).
2. Move to the **PROGRAM MODE**.
3. From the **PROGRAM MODE** menu, press **7** and **CASH** to view the TAXES screen:

```
TAXES
ENTER TAX#
( 1 - 4 )                               4
```

4. Enter the Tax number and press the **CASH** key to confirm.

```
TAXES
1 . DESC :                               [ TAX4 ] ←
2 . TYPE                               [ ADD-ON ]
3 . RATE                               [ 0 . 0 0 0 ]
4 . GST IS BY TAX RATE1                [ N ]
5 . GST IS BY TAX RATE2                [ N ]
6 . GST IS BY TAX RATE3                [ N ]
- PAGE 1 / 1 -
```

5. At the TYPE field, press the ↑ key and the ↓ key and press the **CASH** key to confirm.
6. At the RATE field, input the GST rate and press the **CASH** key to confirm.
7. Enter the percentage rate for the sales tax. For example, if the tax is 6 percent, enter 6000. Press **CASH** to set the rate.
8. At the GST IS BY TAX1 field, if the GST is taxable by rate1 (tax on tax) by pressing the ↑ key and the ↓ key, the pressing the **CASH** key
9. Continue to program additional taxes or press **CLEAR** to return to the **PROGRAM MODE** screen.

Programming a Tax Table

In some cases, a tax that is entered as a percentage does not exactly follow the tax charts that apply in your area (even if the tax chart is based on a percentage). In these cases, we recommend that you enter your tax using tax table programming. This method will match tax collection exactly to the break points of your tax table.

Before programming, obtain a copy of the tax table you wish to program. You will need the printed tax table if you wish to determine the break point entries yourself. The "Tax Table Programming Chart Example: 6% Tax Table" shown below is used as an example in the steps that follow.

Note: You can enter up to 60 break points.

Determining Break Point Entries

1. Examine the printed tax table for the tax you are programming.
2. Refer to the "Tax Table Programming Chart Example: 6% Tax Table" to help with this exercise.
3. Calculate the break point differences by subtracting the high side of the previous range from the high side of the dollar range.
4. Examine the pattern of break point differences to determine when the break points begin to repeat. Mark the beginning break points that do not fit a pattern as "non-repeat breaks." Mark the break points that are repeating in a pattern as "repeat breaks."

Tax Table Programming Chart Example: 6% Tax Table

<u>Tax Charged</u>	<u>Sale Dollar Range</u>	<u>Break point Differences</u>	
\$0.00	\$0.00 - \$0.10		
\$0.01	\$0.11 - \$0.21	11	Non-Repeat
\$0.02	\$0.22 - \$0.38	17	
\$0.03	\$0.39 - \$0.56	18	
\$0.04	\$0.57 - \$0.73	17	
\$0.05	\$0.74 - \$0.91	18	
\$0.06	\$0.92 - \$1.08	17	Repeat
\$0.07	\$1.09 - \$1.24	16	
\$0.08	\$1.25 - \$1.41	17	
\$0.09	\$1.42 - \$1.58	17	
\$0.10	\$1.59 - \$1.74	16	
\$0.11	\$1.75 - \$1.91	17	
\$0.12	\$1.92 - \$2.08	17	
\$0.13	\$2.09 - \$2.24	16	
\$0.14	\$2.25 - \$2.41	17	

To enter the example 6% tax table in tax 1:

Programming a Tax Table

1. From the **PROGRAM MODE** menu, press **7** and **CASH** to view the TAXES screen:

TAXES	
ENTER TAX#	
(1 - 4)	0

2. Enter the Tax number and press the **CASH** key to confirm.

TAXES	
1 . DESC :	[TAX1]
2 . TYPE	[TAX-TABLE]
3 . RATE	[0 . 0 0 0]

3. At the TYPE field, press the \uparrow key and the \downarrow key to select the TAX-TABLE and press the **CASH** key to confirm.
4. Press **CASH** to view the 'NON-TAX AMOUNT' entry field:

TAX TABLE3	
NONTAX AMT	0 . 1 0

5. Enter maximum non-taxable amount then Press **CASH**; The '1ST TAX AMOUNT' field displays:

TAX TABLE3	
NONTAX AMT	0 . 1 0
1 ST TAX AM	0 . 0 1

6. Enter the amount of the first tax that will be charged (typically 1¢) then Press **CASH**; The 'NON-REPEAT BREAK' entry field displays:

TAX TABLE3	
NONTAX AMT	0 . 1 0
1 ST TAX AM	0 . 0 1
NON-REPEAT BREAK	
[1]	0 . 0 0

7. Enter the first Non-Repeat Break and press **CASH**.
8. Continue entering all the Non-Repeat Breaks, when you have entered the last Non-Repeat Break press **CASH**; at the next field don't enter a value, just press **CASH**. The 'REPEAT BREAK' entry field displays:

TAX TABLE3	
NONTAX AMT	0 . 1 0
1 ST TAX AM	0 . 0 1
NON-REPEAT BREAK	
[3]	
REPEAT BREAK	1 . 4 1

9. Enter the first Repeat Break and press **CASH**;
10. Continue entering all the Repeat Breaks, when you have entered the last Repeat Break press **CASH**; at the next field don't enter a value, just press **CASH**.
11. Continue to program additional taxes or press **CLEAR** to return to the **PROGRAM MODE** screen.

Messages

From the **PROGRAM MODE**, press **8** and the **CASH** key for **MESSAGES**. The **MESSAGES** screen displays:

```
MESSAGES
1 . PREAMBLE          ←
2 . POSTAMBLE
3 . ENDORSEMENT
4 . FINANCIAL RPT
5 . CLERK RPT
6 . DATATRAN
      - PAGE 1 / 1 -
```

Preamble

The preamble is a programming message of up to six lines that appears at the top of each receipt and/or guest check.

1. From the **MESSAGES** screen, press **1** and **CASH** to display the **PREAMBLE** screen:

```
PREAMBLE
1 . NO DATA
2 . NO DATA
3 . NO DATA          ←
4 . NO DATA
5 . NO DATA
6 . NO DATA
      - PAGE 1 / 1 -
```

2. Press the **↑** key and the **↓** key to select menu and press the **CASH** key to confirm. Select the Preamble line you wish to program.
3. Continue to program additional Preamble or press **CLEAR** to return to the **PROGRAM MODE** screen.

Postamble

The postamble is a programming message of up to six lines that appears at the bottom of each receipt and/or guest check.

1. From the **MESSAGES** screen, press **2** and **CASH** to display the **POSTAMBLE** screen:

```
POSTAMBLE
1 . NO DATA          ←
2 . NO DATA
3 . NO DATA
4 . NO DATA
5 . NO DATA
6 . NO DATA
      - PAGE 1 / 1 -
```

2. Press the **↑** key and the **↓** key to select menu and press the **CASH** key to confirm. Select the Postamble line you wish to program.
3. Continue to program additional Postamble or press **CLEAR**.

Endorsement

The Endorsement Message is a programming message of up to ten lines that prints when a check is endorsed on an optional slip printer.

1. From the **MESSAGES** screen, press **3** and **CASH** to display the **ENDORSEMENT** screen:

```
                ENDORSEMENT
1 . NO DATA
2 . NO DATA
3 . NO DATA
4 . NO DATA
5 . NO DATA
6 . NO DATA
```

2. Press the \uparrow key and the \downarrow key to select menu and press the **CASH** key to confirm. Select the Endorsement line you wish to program.
3. Type in the desired endorsement message for the selected line; Press **CASH** to accept the entry and continue to the next line.
4. Continue to program additional Endorsement Lines or press **CLEAR** to return to the **PROGRAM MODE** screen.

Financial Report

The Financial Report selection allows you to reprogram the descriptors that appear with the Financial Report totals and counters. For example, the first total on the financial report "+PLU TTL" represents the total of all positive PLU entries. You might want to re-label this total to say "ADJST TTL". You can reprogram any of the Financial Report totals listed here with any 24-character descriptor.

1. From the **MESSAGES** screen, press **4** and **CASH** to display the **FINANCIAL REP MESH.** screen:

```
                FINANCIAL RPT
1 . +PLU TTL
2 . -PLU TTL
3 . ADJST TTL
4 . NONTAX
5 . TAX1 SALES
6 . TAX2 SALES
                -PAGE 1/16-
```

2. Press the \uparrow key and the \downarrow key to select line and press the **CASH** key to confirm. Select the Financial Report line you wish to program.
3. After you have completed typing the descriptor, press **CASH** to accept the new message.
4. Continue to program additional Report message or press **CLEAR** to return to the **PROGRAM MODE** screen.

Default Financial Report Messages

NO	DESCRIPTION
1.	+PLU TTL
2.	-PLU TTL
3.	ADJST TTL
4.	NONTAX
5.	TAX1 SALES
6.	TAX2 SALES
7.	TAX3 SALES
8.	TAX4 SALES
9.	TAX1
10.	TAX2
11.	TAX3
12.	TAX4
13.	XPMT1 SALES
14.	XPMT2 SALES
15.	XPMT3 SALES
16.	XPMT4 SALES
17.	%1
18.	%2
19.	%3
20.	%4
21.	%5
22.	NET SALE
23.	CREDIT TAX1
24.	CREDIT TAX2
25.	CREDIT TAX3
26.	CREDIT TAX4
27.	FD/S CREDIT
28.	RETURN
29.	ERROR CORR
30.	PREVIOS VD
31.	VOID MODE

NO	DESCRIPTION
32.	CANCEL
33.	GROSS SALE
34.	CASH SALES
35.	CHECK SALES
36.	R/A 1
37.	R/A 2
38.	R/A 3
39.	P/O 1
40.	P/O 2
41.	P/O 3
42.	HASH TTL
43.	AUDACTION
44.	NOSALE
45.	CASH-IN-D
46.	CHECK-IN-D
47.	FD/S-IN-D
48.	CHG1-IN-D
49.	CHG2-IN-D
50.	CHG3-IN-D
51.	CHG4-IN-D
52.	CHG5-IN-D
53.	CHG6-IN-D
54.	CHG7-IN-D
55.	CHG8-IN-D
56.	CHG1 SALES
57.	CHG2 SALES
58.	CHG3 SALES
59.	CHG4 SALES
60.	CHG5 SALES
61.	CHG6 SALES
62.	CHG7 SALES

NO	DESCRIPTION
63.	CHG8 SALES
64.	FOREIGN 1
65.	FOREIGN 2
66.	FOREIGN 3
67.	FOREIGN 4
68.	DRAWER TTL
69.	PROMO
70.	WASTE
71.	TRAIN TTL
72.	MIX&MATCH
73.	PLU LEVEL1 TTL
74.	PLU LEVEL2 TTL
75.	MOD1
76.	MOD2
77.	MOD3
78.	MOD4
79.	MOD5
80.	ROUND
81.	EATIN TTL
82.	TAKEOUT TTL
83.	DRTHRU TTL
84.	TIP
85.	BAL FORWARD
86.	GUESTS
87.	P/BAL
88.	CHECKS PAID
89.	SERVICE
90.	V.DINHEIRO
91.	VD SALES REC#

Clerk Report

The Clerk Report selection allows you to reprogram the descriptors that appear with the Clerk Report totals and counters. For example, the first total on the clerk report "NET SALES" might be re-labeled to say, "GROSS SALES". You can reprogram any of the Financial Report totals listed here with any 24-character descriptor.

1. From the **MESSAGES** screen, press **5** and **CASH** to display the **CLERK REP MESG.** screen:

```
          CLERK RPT
1 . NET SALE
2 . NONTAX
3 . TAX1 SALES
4 . TAX2 SALES
5 . TAX3 SALES
6 . TAX4 SALES
```

2. Press the **↑** key and the **↓** key to select line and press the **CASH** key to confirm. Select the Financial Report line you wish to program.
3. After you have completed typing the descriptor, press **CASH** to accept the new message.
4. Continue to program additional Report message or press **CLEAR** to return to the **PROGRAM MODE** screen.

Default Clerk Report Messages

N O	Description
1.	NET SALE
2.	NONTAX
3.	TAX1 SALES
4.	TAX2 SALES
5.	TAX3 SALES
6.	TAX4 SALES
7.	TAX1
8.	TAX2
9.	TAX3
10.	TAX4
11.	XPMT1 SALES
12.	XPMT2 SALES
13.	XPMT3 SALES
14.	XPMT4 SALES
15.	% 1
16.	% 2
17.	% 3
18.	% 4
19.	% 5
20.	CREDIT TAX1
21.	CREDIT TAX2
22.	CREDIT TAX3
23.	CREDIT TAX4
24.	FD/S CREDIT
25.	RETURN

N O	Description
26.	ERROR CORR
27.	PREVIOS VD
28.	VOID MODE
29.	CANCEL
30.	GROSS SALE
31.	CASH SALES
32.	CHECK SALES
33.	R/A 1
34.	R/A 2
35.	R/A 3
36.	P/O 1
37.	P/O 2
38.	P/O 3
39.	HASH TTL
40.	CASH-IN-D
41.	CHECK-IN-D
42.	FD/S-IN-D
43.	CHG1 SALES
44.	CHG2 SALES
45.	CHG3 SALES
46.	CHG4 SALES
47.	CHG5 SALES
48.	CHG6 SALES
49.	CHG7 SALES
50.	CHG8 SALES

N O	Description
51.	FOREIGN 1
52.	FOREIGN 2
53.	FOREIGN 3
54.	FOREIGN 4
55.	DRWR TTL
56.	PROMO
57.	WASTE
58.	TRAIN TTL
59.	NOSALE
60.	MIX&MATCH
61.	PLU LEVEL1 TTL
62.	PLU LEVEL2 TTL
63.	ROUND
64.	EATIN TTL
65.	TAKEOUT TTL
66.	DRTHRU TTL
67.	TIP
68.	BAL FORWARD
69.	GUESTS
70.	P/BAL
71.	CHECKS PAID
72.	SERVICE
73.	V.DINHEIRO
74.	VD SALES REC#

Mix & Match Program

Retailers often offer discounts when multiples of different items are purchased. For example, the offer: “save \$5 on any three bottles of wine” can be handled by a mix and match discount. The HK-7200 Series can accommodate up to 99 (the exact number is determined by memory allocation) different mix and match discounts.

This program sets the number of items that must be purchased to receive the discount and the amount of the discount. You must also set the following additional Mix & Match Table options that are set through separate programs:

- You can set a 24-character descriptor for the discount
- You must link eligible items to the appropriate mix and match table. See “PLU Programming”; and go to Page 6, option #36 of the selected PLU options.

Mix & Match Name/Quantity/Price Settings

Each Mix & Match discount function can be programmed with a unique 24-character descriptor. The number of Mix & Match discounts is set in memory allocation.

1. From the **PROGRAM MODE** screen, press **9** and **CASH** to display the **MIX & MATCH** programming screen:

```
MIX & MATCH
ENTER MIX&MATCH#
( 1 - 20 )                                0
```

2. Enter the number of mix and match you wish to program; Press **CASH** to confirm.

```
MIX & MATCH
1 . DESC :          [ DISCOUNT 01 ] ←
2 . QUANTITY                [ 0 ]
3 . AMOUNT                 [ 0 . 00 ]

- PAGE 1 / 1 -
```

3. The descriptor of Mix and match can be up to 24 characters. Press **CASH** to access. Type in the desired descriptor; Press **CASH** to confirm.
4. Press the ↓ key to select the **QUANTITY** field; Press **CASH** to access. Enter the number of items that need to be purchased to qualify for the discount; Press **CASH** to confirm.
5. Press the ↓ key to select the **AMOUNT** field, Press **CASH** to access. Enter the amount of the discount; Press **CASH** to confirm.
6. Press the **CLEAR** key to return to the MIX & MATCH PGM screen. Select another Mix & Match table to program or press the **CLEAR** to exit.

Program Scans

You can make a printed record of your HK-7200 Series program

1. From the **PROGRAM MODE** menu, press **10** and **CASH** for **PGM SCAN**. The **PROGRAM SCAN** screen displays:

```
PGM SCAN
1. PLU                               ←
2. GROUP
3. FUNCTION KEY
4. OPTIONS
5. EMPLOYEE
6. TIME SCHEDULE
-PAGE 1 / 2-
```

```
PGM SCAN
7. TAX                               ←
8. MESSAGES
9. MIX & MATCH
10. NLU CODE#
11. MACRO
-PAGE 2 / 2-
```

2. Press the ↑ key and the ↓ key to select menu and press the **CASH** key to confirm. Select the **PGM SCAN**. You can also select menu by page ↑ key and page ↓ key.

Program Down

When multiple registers are connected in an IRC network, you can download programs from one register to any or all of the remaining registers.

1. From the **PROGRAM MODE** menu, press **11** and **CASH** for **PROGRAM DOWN**. The **PROGRAM DOWN** screen displays:

```
PROGRAM DOWN
1 . ALL          ←
2 . SELECT

-PAGE 1 / 1 -
```

2. From the **PROGRAM DOWN** screen, press **1** if you want to download all programs to the registers.
3. From the **PROGRAM DOWN** screen, press **2** if you want to download individual program to the register.

```
SELECT
1 . PLU          ←
2 . GROUP
3 . TAX
4 . OPTIONS
5 . TIME OPN
6 . FUNCTION KEY

-PAGE 1 / 2 -
```

4. Press the **↑** key and the **↓** key to select menu and press the **CASH** key to confirm. Select the menu you want to download.

Sample Reports

Financial

	05/01/2019 WED	13:32
	X 1 REPORT	00001

	FINANCIAL	
Total and count of all positive PLUs	+PLU TTL	179.56
Total and count of all Negative PLUs	-PLU TTL	\$288.60
Total of +PLU and -PLU sales	ADJUST TTL	10
Total of Non-taxable sales		-20.00
Total of tax eligible sales for each sale tax		189.56
Total of tax collected for each tax		\$268.60
Total exempted sales for each tax		-----
Total and count for each % function key (i.e. discounts & coupons)	NONTAX	
	\$30.47	
	TAX1 SALES	\$153.60
	TAX2 SALES	\$11.92
	TAX3 SALES	\$16.77
	TAX4 SALES	\$31.89
	TAX1	\$10.00
	TAX2	\$1.21
	TAX3	\$1.18
	TAX4	\$2.18
	XMPT1 SALES	\$7.00
	XMPT2 SALES	\$1.50
	XMPT3 SALES	\$7.95
	XMPT4 SALES	\$7.50
	ITEM DISC.	3
	SALE DISC.	-0.48
		2
		-5.22
	SALE SURCH.	3
		\$3.23
	continued . . .	

continued from previous page

Total and count for each % function key (i.e. discounts & coupons)	→	% 4	0
			\$0.00
		% 5	0
			\$0.00
Net Sales	→	NET SALE	26
			\$281.18
Credited tax for each tax. (Tax is credited for negative taxable sales, i.e. mdse return transactions.)	→	CREDIT TAX1	4
			-1.11
		CREDIT TAX2	1
			-0.23
		CREDIT TAX3	2
			-0.89
		CREDIT TAX4	1
			-0.39
		RETURN	33
			-59.73
Total and count for each type of transaction correction.	→	ERROR CORR	2
			-4.00
		PREVIOUS VD	1
			-1.50
		VOID MODE	-2
			-6.40
		CANCEL	2
			\$16.00
Gross Sales	→	GROSS SALES	\$375.63
Totals and counters for CASH and CHECK sales	→	CASH SALES	13
			\$133.49
		CHECK SALES	1
			\$23.05
		R/A 1	1
			\$145.00
		R/A 2	0
			\$0.00
		R/A 3	0
			\$0.00
Total and count for each type R/A (received on account) and P/O (paid out) key.	→	P/O 1	1
			-140.00
		P/O 2	0
			\$0.00
		P/O 3	0
			\$0.00

continued . . .

Total and count of items sold with HASH status.

Count of No Sales.

Total of numbers entered into the non-add key

Total and count of expected CASH, CHECK in drawer. Declaration amounts and over/short calculations.

Total and count of expected in drawer for each charge function. (Charge in drawer will differ from charge sales if the charge is over-tendered)

continued from previous page

HASH TTL	0
	\$0.00
NOSALE	4
NON ADD #	547
CASH-IN-D	14
	\$269.99
CASH DEC AMT	\$269.99
OVER/SHORT	\$0.00
CHECK-IN-D	3
	-108.45
CHECK DEC AMT	\$0.00
OVER/SHORT	-108.45
CHG1-IN-D	0
	\$0.00
CHG1 DEC AMT	\$0.00
OVER/SHORT	\$0.00
CHG2-IN-D	1
CHG2 DEC AMT	\$0.00
OVER/SHORT	\$0.00
	\$8.43
CHG3-IN-D	1
	\$8.52
CHG3 DEC AMT	\$0.00
OVER/SHORT	\$0.00
CHG4-IN-D	2
	-1.60
CHG4 DEC AMT	\$0.00
OVER/SHORT	\$0.00
CHG5-IN-D	1
	\$2.67
CHG5 DEC AMT	\$0.00
OVER/SHORT	\$0.00
CHG6-IN-D	2
	\$13.09
CHG6 DEC AMT	\$0.00
OVER/SHORT	\$0.00
CHG7-IN-D	0
	\$0.00
CHG7 DEC AMT	\$0.00
OVER/SHORT	\$0.00
CHG8-IN-D	1
	\$3.04
CHG8 DEC AMT	\$0.00
OVER/SHORT	\$0.00

continued . . .

continued from previous page

Total and count for each CHARGE key.

Total for each Foreign currency in drawer.

Total of CASH, CHECKS and CHARGES in drawer.

Total and count for PROMO and WASTE.

Number of transactions and total activity in Training Mode

Total sales for each type of destination

Total and count of balances entered into PBAL key

Total and count of balances paid

Total and count of items serviced

CHG1 SALES	0	
	\$0.00	
CHG2 SALES	1	
	\$8.43	
CHG3 SALES	1	
	\$8.52	
CHG4 SALES	2	
	-1.60	
CHG5 SALES	1	
	\$2.67	
CHG6 SALES	2	
	\$13.09	
CHG7 SALES	0	
	\$0.00	
CHG8 SALES	1	
	\$3.04	
FOREIGN 1	0.00	
FOREIGN 2	0.00	
FOREIGN 3	0.00	
FOREIGN 4	0.00	
DRWR TTL	\$216.69	
PROMO	1	
	\$1.50	
WASTE	8	
	\$12.50	
TRAIN TTL	5	
	\$62.59	
MIX & MATCH	0	
	\$0.00	
EATIN TTL	1	
	\$10.12	
TAKEOUT TTL	2	
	\$40.77	
DRTHRU TTL	1	
	\$3.04	
BAL FORWARD	4	
	\$88.13	
GUESTS	5	
P/BAL	4	
	\$0.00	
CHECKS PAID	2	
	\$18.64	
SERVICE	4	
	\$88.13	
AVG ITEM/CUST	7.29	
AVG \$/CUST	\$10.81	

GRAND	\$375.63	
CLERK 01	00209	00000

Mix & Match Discounts applied

Total number of guests served

Total and count of all balances serviced

Average number if items per customer, and average dollar sales per customer

Grand total

Time

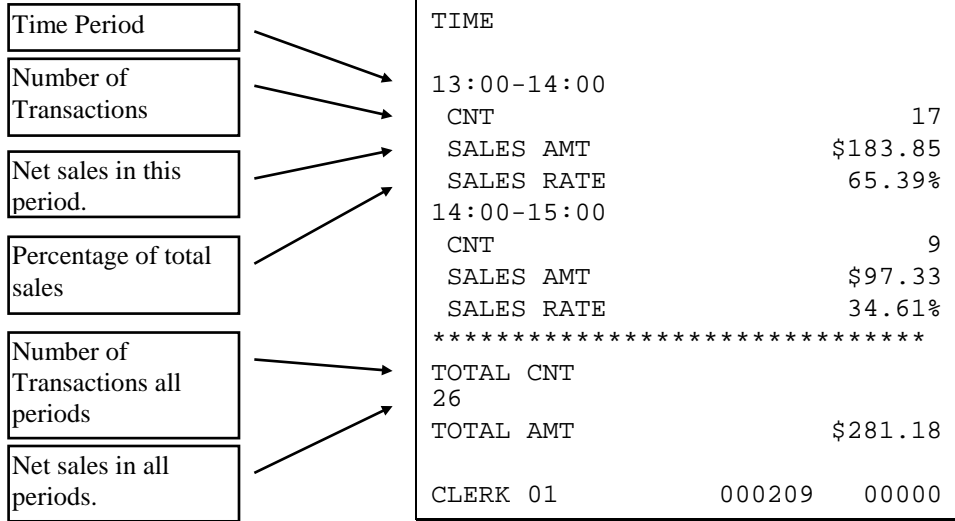

PLU

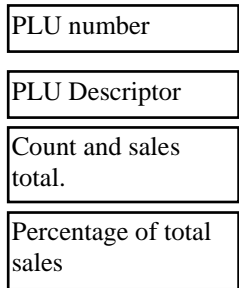

05/01/2019 WED		13:32
X 1	REPORT	00001

ALL PLU		
PLU#1	HAMBURGER	
CNT 28		\$42.00
SALES RATE		15.64%
PLU#2	DBL BURGER	
CNT 40		\$99.75
SALES RATE		37.14%
PLU#4	COKE	
CNT 26		\$38.85
SALES RATE		14.46%
PLU#5	SPRITE	
CNT 18		\$13.42
SALES RATE		5.00%
PLU#7	ROAST	
CNT 19.16		\$30.47
SALES RATE		11.34%
PLU#28	UNLEADED	
CNT 32.85		\$39.39
SALES RATE		14.66%
PLU#29	RETURNS	
CNT 10		-20.00
SALES RATE		-7.44%
PLU#33	NAILS	
CNT 15.55		\$24.72
SALES RATE		9.20%

TOTAL CNT		189.56
TOTAL AMT		\$268.60
CLERK 01	000209	00000

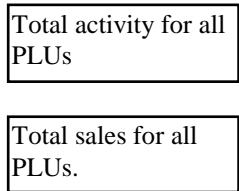

Clerk

Note: Media totals can be printed for each clerk, if selected in "REPORT" of the Options Programming.

Clerk Name	→	05/01/2019 WED	13:32
Number of Transactions	→	X 1 REPORT	00001
Net sales for this clerk	→	ALL CLERK	
Drawer total for this clerk	→	SUNNY	
		NET SALE	10
			\$155.23
		DRWR TTL	\$109.81
		ZACH	
		NET SALE	5
			\$45.14
		DRWR TTL	\$43.22
		ANNA	
		NET SALE	4
			\$78.75
		DRWR TTL	\$67.03
		LAURA	
		NET SALE	2
			\$0.00
		DRWR TTL	\$18.64
		PEGGY	
		MOLLY	
		NET SALE	5
			\$2.06
		DRWR TTL	-22.01
		CLERK 01	000209 00000

Individual Clerk

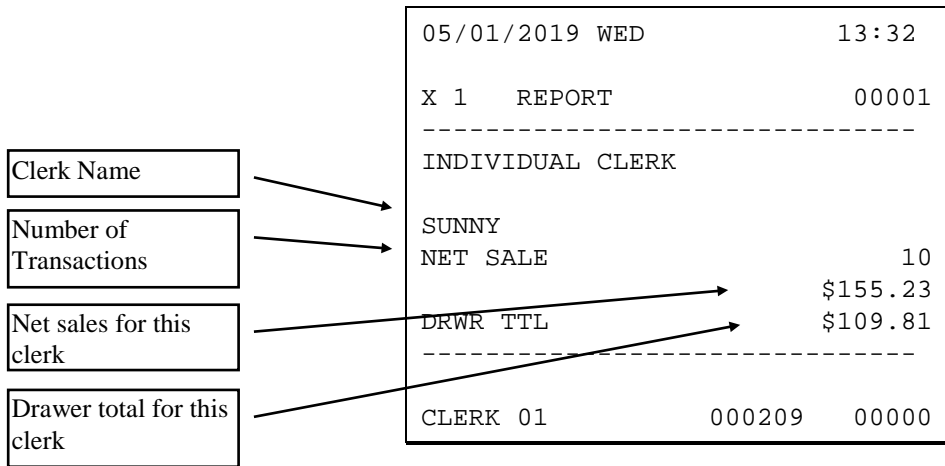

Groups

	05/01/2019 WED	13:32
	X 1 REPORT	00001

Group Descriptor	GROUP	
Number of items sold in this group	#1: FOOD	
	CNT	68
	SALES AMT	\$141.75
Net sales for this group	#2: DRINK	
	CNT	44
	SALES AMT	\$52.27
	#3: REST.	
	CNT	112
	SALES AMT	\$194.02
	#5: STORE	
	CNT	19.16
	SALES AMT	\$30.47
	#8: MDSE	
	CNT	58.40
	SALES AMT	\$44.11
	#9: STORE MDSE	
	CNT	77.56
	SALES AMT	\$74.58

Number of items sold in all groups.	TOTAL CNT	189.56
Net sales for all groups.	TOTAL AMT	\$268.60
	CLERK 01	000209 00000

Day

The Day (Daily Sales) report lists net sales for each day of the month.

Count
Net Sales
Percentage of total

```
05/01/2019 WED 13:32
X 2 REPORT 00001
-----
DAY
DAY : 12
CNT 2
SALES AMT $6.00
SALES RATE 50.00%
DAY : 12
CNT 2
SALES AMT $6.00
SALES RATE 50.00%
*****
TOTAL CNT 4
TOTAL AMT $12.00
CLERK 01 000209 00000
```

Stock

PLU number
PLU Descriptor
Current inventory count

```
05/01/2019 WED 13:32
X 1 REPORT 00001
-----
ALL PLU STOCK
PLU#1
HAMBURGER
CNT 26
PLU#2
DBL BURGER
CNT 15
PLU#7
ROAST
CNT 25.96
PLU#28
UNLEADED
CNT 1488.47
PLU#33
NAILS
CNT 161.25
CLERK 01 000209 00000
```

Check File

Open check number and balance.	05/01/2019 WED	13:32
Clerk responsible for the check.	X 1 REPORT	00001

	OPEN CHECK	
	CHECK : 3	\$24.07
	MOLLY	
	CHECK : 4	\$45.42
	SUNNY	
	CHECK : 5	\$24.50
	KELLY	
	CHECK : 6	\$28.33
	SUNNY	
	CLERK 01	000209 00000

Drawer Totals

Cash in drawer total	05/01/2019 WED	13:32
Check in drawer total	X 1 REPORT	00001
Charge (1-8) in drawer total	-----	
	IN-DRAWER	
	CASH-IN-D	\$0.00
	CHECK-IN-D	\$0.00
	CHG1-IN-D	\$0.00
	CHG2-IN-D	\$0.00
	CHG3-IN-D	\$0.00
	CHG4-IN-D	\$0.00
	CHG5-IN-D	\$0.00
	CHG6-IN-D	\$0.00
	CHG7-IN-D	\$0.00
	CHG8-IN-D	\$0.00
	CLERK 01	000209 00000

Balancing Formulas

+/-	Net Sales	\$ Example
=	PLU Sales Total	\$
+	Tax 1	\$
+	Tax 2	\$
+	Tax 3	\$
+	Tax 4	\$
+	Sale Coupon Amounts	\$
+	Sale Percent Discounts	\$
+	Sale Surcharge Amounts	\$
=	Net Sales	\$

+/-	Gross Sales	\$ Example
=	Net Sales	\$
+	Negative PLU Total	\$
+	Item Coupon Total	\$
+	Item Percent Discount	\$
+	Sale Coupon Amounts	\$
+	Sale Percent Discounts	\$
+	Credit Tax 1	\$
+	Credit Tax 2	\$
+	Credit Tax 3	\$
+	Credit Tax 4	\$
+	Merchandise Return	\$
+	Void mode Total	\$
+	Mix & Match Total	\$
=	Gross Sales	\$

Required ECR Program Settings

Define Port (Serial Port Options)

You must define one of the three serial communication ports for the DataCap device you will be using for EMV.

Port Settings

1. At the **SERVICE MODE**, press **5** and **CASH** for RS232C programming. The port selection screen displays:

```
          DEFINE PORT
1 . PORT 1
2 . PORT 2
3 . USB TYPE
4 . SCAN

          - PAGE 1 / 1 -
```

2. Enter the digit (1-4) corresponding to the port you wish to program. Press the **5** and **CASH** to print Port 1, Port 2 settings. The **appropriate PORT PROGRAM** screen displays:

```
          PORT 1
1 . BAUD RATE           [ 19200 ]
2 . PARITY              [ NONE ]
3 . DATA BITS          [ 8BITS ]
4 . STO PBITS          [ 1BIT ]
5 . DEVICE              [ DATATRAN ]

          - PAGE 1 / 1 -
```

3. Use the \uparrow key and the \downarrow key to scroll up and down through the eleven serial port options. Make settings or changes as needed.
4. Press the **CLEAR** key to finalize and return to the DEFINE PORT screen.

Serial port Settings Screen Program Notes

#	Option	Description
1	BAUD RATE	Select 19200 for EMV enabled DataCap devices
2	PARITY	Select NONE
3	DATA BITS	Select 8
4	STOP BITS	Select 1
5	DEVICE FUNCTION	Select EMV → then select DATATRAN

System Options

Options are organized into different categories, i.e. System, Print, Report, etc. to make it easier for the programmer to find and set options. Specific System Options are required for Integrated Payment to operate properly.

1. At the **PROGRAM MODE**, press **4** and **CASH** for **OPTIONS** Programming. The **OPTIONS** screen displays:

```

                                OPTIONS
1 . SYSTEM
2 . PRINT
3 . REPORT
4 . TAX
5 . CURRENCY
6 . ROUNDING
                                - PAGE 1 / 3 -

```

2. Press **1 CASH** to select the “SYSTEM” options category.
3. Use the **↑** key and the **↓** key to scroll up and down through the options in the category. Press the **↑** key and the **↓** key to choose the appropriate setting for the options.
4. Press the **CASH** key to confirm the option value and return system option screen.

EMV Related System Options

#	System Option	Entry	Description
48	EFT DRAFT	DATATRAN FINE DINING	Select if the EFT draft is Fine Dining. Fine dining draft will print a tip line. Select Datatran to not print tip line.
49	MSR CONNECT	DATATRAN PDC	Select device where the card reader is connected; For EMV installations always select PDC .
50	PIN-PAD TYPE	DUKPT ROTAT	Always choose PIN-Pad type as DUKPT .
51	PIN-PAD PORT	0-3	Select the port# where Pin-Pad is connected
52	COPY OF DATATRAN RECEIPT	0-99	Set desired number of EFT receipts to print (default = 1)
53	MARK CARD No ON ALL EFT DRAFTS	Y or N	Set to N to NOT print card number on EFT receipts.
54	“test” CLERK ID?	Y or N	Always set to N
55	CARDHOLDER NAME?	Y or N	Set to Y if you want the cardholder’s name printed on EFT receipts.

Function Key Programming

Program the appropriate Charge function keys that will be used to finalize electronic payment transactions; Charge key function keys are key codes 323-330. Charge keys can be programmed as Credit, Debit, Gift, Gift No NSF or Cash Benefit keys.

Charge keys must be assigned to the keyboard before programming the option settings.

Charge Key Programming

1. From the **PROGRAM MODE**, press **3** and **CASH** for **FUNCTION KEY**. The **FUNCTION KEY PROGRAM** screen displays:

```
FUNCTION KEY
1 . FUNCTION KEY
2 . MACRO KEY
```

2. Press **1** and **CASH** to select **FUNCTION KEY** menu.

```
FUNCTION KEY

ENTER FUNC . KEY
TO BE PROGRAMMED
```

3. Press the **CHARGE** key you wish to program.
4. Use the **↑** key and the **↓** key to scroll up and down through the options for the function key you have selected. The pages that follow detail the reference information for each key.
5. Select option “**14.SEND TO EFT**” and press the **CASH**, press the **↑** key and the **↓** key to select the option value to **[Y]**, press the **CASH** to save the setting.
6. Select option “**15.EFT PORT (0-3)**” and press the **CASH**. Enter the port number where the DataTran device is connected and press **CLEAR** to set the value and return to the charge key programming.
7. Select option “**17.SELECT CARD TYPE**” and press the **CASH**. Use the **↑** key and the **↓** key to scroll up and down through the options until the correct card type is displayed. Press the **CASH** to save the setting.
8. Select option “**18.SHOW TIP ON**” and press the **CASH**. Use the **↑** key and the **↓** key to scroll up and down through the options until the desired option is displayed. Press the **CASH** to save the setting
9. Press **CLEAR** to return to the **FUNCTION KEY** menu.
10. Press **CLEAR** again to return to the **PROGRAM MODE** menu

Charge Key (1-8) Options

	Option	Entry	Description
1	DESC	Alpha numeric 18 character	You can program a unique descriptor. The default descriptors are CHARGE 1-8.
2	HALO	7-digit amount	You can limit errors by setting the maximum amount that can be tendered. "0" means that there is no entry limit.
3	AMOUNT TEND COMP.	Y or N	Select Y if you want to force the operator to enter the tendered amount and let the register calculate the change.
4	OVER/UNDER TENDER IN MGR CONTROL	Y or N	Select Y if you do not want the operator to tender more than the amount of the sale and issue change. When selected, over tendering is allowed only in the MANAGER MODE.
5	DISABLE UNDER TEND.	Y or N	Select Y if you do not want the operator to tender less than the amount of the sale.
6	DOES DRAWER OPEN	Y or N	Select N if you do not want the drawer to be opened with this key.
7	ALLOW OVER TEND.	Y or N	Select Y if you wish to allow tender greater than the amount of the sale.
8	NON-ADD # ENTRY COMPULSORY	Y or N	Select Y if you wish to enforce the entry of a non-add number prior to tendering.
9 - 12	EXEMPT TAX 1 – TAX4	Y or N	Select Y to exempt the appropriate tax automatically when finalized with this key.
13	COMPULSORY VALIDATION	Y or N	Choose Y to enforce validation if an optional printer with validation capability is connected to a Serial port.
14	SEND TO EFT	Y or N	Set to Y for integrated payment EFT/EMV operations.
15	EFT PORT (0-3)	[0-3]	Enter the port # where the integrated payment device is connected.
16	ALLOW ROUNDING	Y or N	Select Y if you wish to allow rounding when pressing the CHARGE 1~CHARGE 8 key. <i>Always N for EMV</i>
17	SELECT CARD TYPE	[Card Type]	None, Credit, Debit, Gift, Gift No NSF, Cash Benefit
18	SHOW TIP ON <i>(See ** Note: below)</i>	[Selection]	REG PINPAD PRINT TIP LINE ONLY

**** Note:** Before selecting charge key option 18 setting, determine the Transaction Type (type of card) and when tips are to be entered:

- If the card is a CREDIT card, and the draft will be presented to the customer and the tip will be added later from the TIP OPERATION function of the DATATRAN OPERATION menu, select (PRINT TIP LINE ONLY).
- If the card is a CREDIT card, and all payments are made at a cashier station, choose (REG) to prompt for tip entry on the ECR display; choose (PINPAD) to prompt for tip at the PIN-Pad.

-
- **Tips cannot be edited/added to Debit transactions after the sale.**
 - **No TIP entry is allowed for GIFT Card transactions. Tips must be entered using a PLU prior to finalization with a *Gift Card*.**
 - **When using IPTran LT terminals at each register, tips must be entered at the terminal the transaction was registered on.**
-

DataTran Tip Key

Firmware versions supporting EMV provide DataTran TIP function key (key code 416) for entering TIP's in register mode. If your application is set for "Fine Dining" you can place this function on the keyboard to speed up the TIP entry. The key can be programmable for manager control if desired.

1. Move the key to the **P** lock position to display the **Program Mode** menu.
2. Press the **↑** key and the **↓** key to select "**3.FUNCTION KEY**" and press **CASH** or press **3** and **CASH** to display the **FUNCTION KEY** screen.

```

FUNCTION KEY
1 . FUNCTION KEY
2 . MACRO KEY
```

3. Press **1** and **CASH** to select **FUNCTION KEY** menu.

```

FUNCTION KEY

ENTER FUNC . KEY
TO BE PROGRAMMED
```

4. Press the "**DATARAN TIP**" key to program the settings. Use the **↑** key and the **↓** key to scroll up and down through the options for the "DATATRAN TIP" key.
5. Select an option and press the **CASH** to set that option value.
6. From the YES/No type option screen, Press the **↑** key and the **↓** key to scroll up and down through the options until the desired option is displayed. Press the **CASH** to confirm the option selection.

DataTran TIP Key Options

	Option	Entry	Description
1	DESC	Alpha numeric 18 character	You can program a unique descriptor. The default descriptors are CHARGE 1-8.
2	Under manager control	Y or N	Select Y to allow TIP operations only in X position manager mode.
3	SEND TO EFT	Y or N	Set to Y for integrated payment EFT/EMV operations.

Glossary

Activity Count

The activity counter increments each time an entry is made on a particular PLU, or function key. The counter prints on the appropriate reports.

Cancel

Press the CANCEL function to abort a transaction in progress. All current items are removed (voided).

Cash Declaration

This option forces the operator to count the cash drawer and input the results before the financial report can be taken. Absentee owners may want clerks or managers to declare the drawer counts to ensure that all cash is deposited, regardless of overages, or shortages. As an added benefit, the overage or shortage amount is calculated and printed on the financial report.

Clerk

Sales clerks are individuals who are responsible for selling the merchandise to the customer. Typically, management wants to know merchandise sales levels for each clerk, in order to monitor productivity, account for cash and other media, and/or pay commissions. The default program provides operation for 15 clerks, however up to 99 different clerks can be used by changing the default memory allocation.

Compulsory

When an operation is programmed compulsory, the appropriate entry must be performed in order to complete the operation.

Compulsory Amount Tendering

This forces the operator to input the tender, rather than pressing a payment key directly. The change will always be computed by the register when a customer tenders an amount greater than the total due. Compulsory tendering will reduce cashier change errors.

Compulsory Condiment

When a kitchen printer, or requisition system is used, the merchant may wish to force the entry of a condiment or instruction for specific items. If compulsory condiment status is set for a specific PLU, then a condiment PLU must follow the entry of the item.

Compulsory Drawer

With compulsory drawer enabled, the clerk cannot begin a new transaction until the drawer is closed. This simple feature was designed to teach cashiers the habit of closing the cash drawer after each transaction. You'll reduce potential errors, theft and fraud that can take place when your cashier works out of an open drawer.

Compulsory Number Entry

This option forces the operator to enter a reference number (using the #/NS key) before a PLU entry can be made or a transaction finalized with a Charge key. The number could represent an SKU number that would be tracked manually, or other data such as a customer count.

Consecutive Number

A sequential number is printed on each receipt issued. This is not a "customer count" as this number is incremented for non-sales activity such as no-sales and reports. A count of revenue generating transactions (true customer count) is printed with the Net Sales total on the financial report.

Currency Conversion

Use the currency conversion function to convert and display the value of the transaction in foreign currency. Only cash tender is allowed after pressing the currency conversion function. Change is calculated and issued in home currency.

Decimal Multiplication

If you sell weighed goods, yard goods, or any merchandise sold in fractions of a unit, the decimal multiplication feature calculates each transaction quickly and accurately. For example, if your customer selects 4.75 pounds of an item sold at \$1.59 per pound, you enter 4.75 on the numeric keypad, press the X/TIME (multiplication) key, then enter the price per pound and press the appropriate PLU key.

Default Program

The default program is the original program installed in the HK-7200 Series. The register has a default program which makes it operational after a memory clear. Nearly all options, rates and status programs are set to zero as the default condition.

Department

The HK-7200 Series uses price look-ups (PLU's) to perform the function of traditional cash register departments. PLU's may be registered directly on the keyboard (like traditional departments) or indirectly by entering the item or PLU number and then pressing the PLU key.

Electronic Journal

The HK-7200 Series provide a traditional journal printer. Today many systems, even expensive PC-based systems do not print a traditional sales journal. For business records, a copy of daily financial summaries is usually all that is needed. Like some of the more expensive POS systems, the HK-SYSTEMS HK-7200 Series have the capability of storing a sales journal in memory. The electronic journal can be reviewed and discarded, saved to an SD card or polled by a PC for archival. When ECR memory reserved for electronic journal is full, current records are saved and old data is discarded.

Error Condition

An error condition signals that mis-operation has occurred. It is identified by an audible tone and an error descriptor appearing on the display.

Error Correct

An error correct operation voids the last item entered, it must be used within a sale.

Flash ROM

Flash ROM is used by the manufacturer to contain the program that runs the register. Flash ROMs maintain memory when power is off, allowing the register to be especially stable and reliable. When the register's program is improved, or updated, the Flash ROM can be updated by a qualified service technician through a utility in the register.

Gallonage

To simplify gasoline transactions, PLU's can be designated to calculate gallons sold on fuel purchases. The price of the fuel sold is entered as it would be in a normal "open" PLU. However, the price per gallon of fuel is entered where the PLU preset price is normally maintained. When fuel is sold, the register will refer to the programmed price per gallon and calculate the number of gallons sold. Both the gallons pumped and dollar amount of the gas purchase are conveniently printed on the customer receipt and sales journal. This provides all the necessary information for a customer that needs a receipt for gas purchases. The total of gallons sold is also maintained on the appropriate PLU report, in the place of the PLU item counter. Several gallonage PLU's could be placed on the keyboard to maintain records for different pumps, or types of fuel. Thus, the dollar and gallon totals can provide a useful security check against separate pump totals.

Groups (PLU Groups)

Groups are used to organize sets of items. For example, in a restaurant Grill Items, Drinks, and Ice Cream items might be separated into different groups. Up to 99 group totals are available. Group reporting is available on the group report.

HALO

The high amount lock-out (HALO) limits the amount allowed to be entered in a PLU, or function key.

HASH

Merchants often sell non-merchandise items, such as lottery tickets, or bottle deposits, that they do not wish to account for as reportable revenue. HASH PLU's are useful to account for non-revenue income. They will add to the appropriate totals on the PLU report, they will add to the transaction totals, and they will be accountable for in drawer totals, but they will not affect the merchants, NET SALES, GROSS SALES or NON-RESETTABLE GRAND TOTAL. As a system of options programming, HASH can be defined to not add to the transaction (NON-ADD).

Link (PLU Link)

Use linked PLU's if you wish the registration a PLU to automatically cause the registration of another PLU (for example to automatically add a bottle deposit.) Linked PLU's are set with Program 350, PLU Link programming.

Macro

Macro keys may be programmed to record, and then later perform, up to 50 keystrokes.

For example, a macro key could be set to tender (preset tender) a common currency, such as \$5 into the cash key.

Memory Allocation

Memory allocation is a program that determines how the system memory is divided to provide the correct features for your application. For example, you may require more or less clerk memory, PLU's, or electronic journal memory. Memory allocation allows you to maximize the features you need while minimizing the features you do not need.

Mix & Match

Retailers often offer discounts when multiples of different items are purchased. For example, the offer: "save \$5 on any three bottles of wine" can be handled by a mix and match discount. The default HK-7200 Series can accommodate up to 10 different mix and match discounts, the total can be increased to a maximum of 100 through memory allocation.

Multiple Receipts

In some cases, for example where a mail-in rebate is offered, an extra copy of a receipt is needed. If allowed, the receipt must be re-printed immediately, before another transaction is started.

Negative PLU's

As you program PLU's, you will find a setting to make them negative (normally they are positive). Positive PLU's are used for items that add to the sale. Negative PLU's are used for items that subtract from a sale, like individual store coupons or bottle deposit credits.

NLU

Number Look-Up (NLU) refers to PLU code that is accessed when a Keyboard PLU is used. In the default program each Keyboard PLU will look up the appropriate numeric PLU, beginning with PLU #1 for Keyboard PLU key #1 and continuing sequentially through the keyboard.

However, this numbering sequence may be impractical for some applications. For example, Keyboard PLU #1 may represent a can of *Diet Pepsi*. The merchant may wish to have the Keyboard PLU look up the UPC code number for *Diet Pepsi*, which is "120500". Using this program, you can change the Number Look-Up (NLU) for the keyboard PLU to any 14-digit number you choose.

No Sale

No sale is an operation to simply open the cash drawer. No sales are counted and reported on the financial report.

Not Found PLU

For small merchants, the HK-7200 Series can build a PLU file "on the fly". Each time an item is scanned (or entered by PLU number) that is not in the PLU file, the operator is prompted to enter the price and other options for the item. At the end of the day, the "Not Found PLU Report" will allow the manager to verify the prices and update the PLU file as needed.

Open (PLU)

Open PLU's accept price entries, rather than register a preset price. To prevent errors, you may set a high limit (HALO) for open entries.

Override

Override is an operation used to bypass a programmed price or entry limit (HALO).

Over-Tendering/Under-Tendering

When a payment is made less than the amount due, it is called an under-tender. After an under-tender, the register calculates and displays the remaining balance for the sale. Additional payments must be made until the total due is satisfied. When the sale is fully paid, the cash drawer will then open and the receipt is completed. When a payment is made more than the amount due, it is called an over-tender. The register will compute and display the change due and the receipt will be completed. Note that register options can be set to allow or disallow over-tendering for check and charge payments.

Paid Out

The Paid Out key is used to track cash paid out of the cash drawer or to record pick ups from the cash drawer.

PLU's

Price look-ups (PLU's) are accessed by indexing a code number and pressing the PLU key, or by pressing a keyboard PLU key. PLU's can be programmed with a preset or open price. PLU's record an activity count and dollar total on the PLU report. PLU sales may also report to a group.

Post Tender

Post tendering is available to help prevent cashier confusion when a customer decides to change the tender amount. When Post Tendering is allowed, the operator can re-enter a cash tender and the register will re-calculate the change.

To post tender after finalizing the sale, enter the cash amount presented by the customer and then press CASH. The amount of change due to the customer is then displayed. This is a calculation function only, and no totals or counters are updated by the use of this feature.

Preamble/Postamble Message

Programmable messages allow each merchant to customize his receipt with the store name, address, phone number, website or other critical identification information or advertising messages. The HK-SYSTEMS HK-7200 Series allows a preamble message of up to six lines, each with up to 32-characters, to be printed at the top of each receipt. A postamble of up to 6-lines of 32-characters can also be printed at the bottom of the receipt. (3 Inch Printer 48 characters)

Preset (PLU)

When a PLU is pre-programmed, or pre-set with a fixed amount, the preset amount will automatically register when the PLU is pressed or entered.

Preset Override

When a PLU is preset, it is possible to override the preset price with a different price. If the override function is set to be allowed in the PLU program, you can simply enter a new price and press the PLU key.

Receipt

A receipt is a printed tape given to a customer as a record of the sale transaction.

Received on Account

The Received On Account key is used to track cash received into the cash drawer or to record loans to the cash drawer.

Register Number

The number of the register can be set and printed on each receipt. If the merchant uses more than one register, or has more than one location, the register where a transaction took place or report was taken is easily identified.

Single Item

The transaction is finalized automatically when a single item PLU is registered as the first item in a sale. Single item status is used to speed transaction entry when an item is normally sold in a one-item sale, for example, a pack of cigarettes, a newspaper or an admission ticket.

Split Pricing

Often merchants price items in multiples, for example 3 for \$1. The register will compute the price of items when the exact quantity is not purchased. If the customer chooses to buy 2 items at 3 for \$1, enter 2, press the X/TIME key, enter 3, press the X/TIME key and then enter the price and the PLU. The register will compute the price for the items purchased.

Stock (PLU Stock)

Each PLU reports an activity counter. Normally the activity counter increments (adds) and is reset when a PLU Z-report is taken. You can choose to use the PLU activity counter as a stock counter. If used as a stock counter, each PLU activity will reduce the count. A separate program allows you to add to the stock count or enter a new stock count. Stock counts are not reset when PLU Z-reports are taken.

Surcharge (Item)

An item percent surcharge adds a percentage to the price of an item. This addition nets the PLU total.

Surcharge (Sale)

A sale percent surcharge adds a percentage to the entire sale.

Tax Computation by Rate/Tax Computation by Table

In the simplest method of tax calculation, the register is set with a tax rate (or rates) and the taxes are computed by a percentage calculation. In some cases, a tax that is entered as a percentage does not follow exactly the tax charts that apply in your area (even if the tax chart is based on a percentage). In these cases, we recommend that you enter your tax using tax table programming. This method will match tax collection exactly to the break points of your tax table.

Tax Exempt

Tax exempt is used to exclude the tax from an entire sale.

Tax Shift

Tax shift keys are used to reverse the tax status of a PLU entry.

Tender

A tender is the register operation in which the amount of the payment is entered. If the tender exceeds the amount due, the sale is finalized and change due is displayed.

Training Operation

Training operations do not add to PLU or function key totals. This allows an operator to practice making entries without updating sales totals. If you wish to perform training operations, designate one of the clerks for training. You must clear (Z) the register before the training clerk can be used. When that clerk is signed on, the register is in “training mode”.

Transaction Number

See consecutive number.

VAT

Value-Added Tax (VAT) is a tax collection system where a portion of the item’s sale price is tax. VAT is different than most sales taxes where tax amounts are calculated and added-on to the sale. Value added taxes are included in the item price.

Void

A void operation will erase a previous item entry. It must be used inside of a sale only.

X & Z Reports

X (eXamine) reads reports without resetting and Z (Zero) reads and resets your sales totals.

CE

JK68-60700A(Rev.01)