

# TRUBLUE iQ / TRUBLUE iQ XL AUTO BELAY

## Operator Manual

Models: TBIQ-LT / TBIQ-XL



### NOTE TO INSTALLERS

Always Read Instructions Before Use

Leave this Operator Manual attached to the auto belay. The Operator Manual contains information relating to the safe use of the TRUBLUE iQ Auto Belay and includes all product registration and Warranty information. This document may only be removed by the Owner/operator. Ensure that this Operator Manual is readily available to operators at all times

**Head Rush Technologies** TRUBLUE iQ Operator Manual  
P/N 12765-04

Head Rush Technologies products are covered by a number of patents, including  
**U.S. Patents** 8,490,751; 8,851,235; 9,016,435; 8,851,235 and D654,412  
& corresponding patents/applications in the USA and in other countries worldwide.





# TABLE OF CONTENTS

<b>1.0</b>	<b>SAFETY INFORMATION</b>	6
1.1	Symbols Used in this Manual	6
<b>2.0</b>	<b>WARRANTY CONDITIONS</b>	7
2.1	Customer Responsibility	7
<b>3.0</b>	<b>CERTIFICATION</b>	9
3.1	Standards	9
<b>4.0</b>	<b>DESCRIPTION</b>	10
<b>5.0</b>	<b>SPECIFICATIONS</b>	11
<b>6.0</b>	<b>AUTO BELAY PARTS</b>	12
6.1	Label	12
6.2	Location of Safety Labels	13
6.3	Icon Descriptions	14
<b>7.0</b>	<b>UNPACKING</b>	16
7.1	Precautions	16
7.2	Receipt of the Auto Belay	16
7.3	Unpacking the Auto Belay	16
7.4	Storage	17
<b>8.0</b>	<b>INSTALLATION</b>	18
8.1	Precautions	18
8.2	Standards	18
8.2.1	<i>Anchor Points</i>	18
8.2.2	<i>Harness</i>	19
8.2.3	<i>Secondary Connectors</i>	19
8.2.4	<i>Selecting a Location</i>	19
8.2.5	<i>Outdoor Installations</i>	20
8.2.6	<i>Mounting Points</i>	20
8.2.7	<i>Orientation</i>	21
<b>9.0</b>	<b>OPERATION</b>	23
9.1	Operator Training	24
9.2	User Instruction	24
9.3	Harness	25
9.4	Carabiner Use	25
9.4.1	<i>Operation</i>	26
9.4.2	<i>Secondary Connections to the Harness</i>	26

---

<b>10.0 INSPECTION &amp; MAINTENANCE</b>	27
10.1 Annual Recertification	27
10.2 Scheduled Maintenance	27
10.2.1 Safety Precautions	28
10.3 Daily Inspection	28
10.4 Weekly Inspection	28
10.4.1 Inspection Procedure	29
10.4.2 Webbing Wear	30
10.5 Six Month Inspection	33
10.5.1 Inspection Procedure	33
10.5.2 Webbing Inspection	33
10.6 Nozzle Replacement	35
10.7 Webbing Line Replacement	36
10.7.1 Safety Precautions	36
10.7.2 Webbing Line Replacement Procedure	37
10.8 Replacement Parts	39
10.9 Troubleshooting	39
10.10 Transportation	40
10.11 Upgrades	40
<b>11.0 MANUFACTURER'S DETAILS</b>	40
<b>12.0 INSPECTION LOGS</b>	41
12.1 Weekly Inspection Log	41
12.2 Six Month Inspection Log	43



## **IMPORTANT SAFETY NOTICE**

### **Climbing/Descent from Height Is a Dangerous Activity**

---

#### **Read Before Installation & Operation**

**Failure by the operator to heed any and all instructions, warnings and cautions for the correct installation, operation, care and maintenance of the TRUBLUE iQ Auto Belay may result in death and/or serious injury.**

TRUBLUE iQ Auto Belay Model TBiQ-LT and Model TBiQ-XL and their associated equipment are designed and specified for use in the recreational climbing/aerial adventure industry as a controlled descent device. Use of the TRUBLUE iQ Auto Belay for any purposes other than that intended by the Manufacturer is not permitted.

Owners and operators of the TRUBLUE iQ Auto Belay are responsible for the safety and training of any person using the TRUBLUE iQ Auto Belay and are required to undergo training in the correct installation and operation of the device prior to any use.

These instructions must be made readily available to the operator at all times. Prior to installation and use, all owners and operators must have read and shown to have understood all instructions, labels, markings, and safety information pertaining to the installation, operation, care, and maintenance of the TRUBLUE iQ Auto Belay system, its component parts, and all associated hardware. Users of the TRUBLUE iQ Auto Belay must be trained on proper usage of the Auto Belay. It is the responsibility of owner/operator to provide this training. Failure to do so can result in death, serious injury, and equipment damage.

#### **Health and Safety**

Owners and operators must abide by all Standards, International, Federal, State and Provincial laws, and any specific health and safety regulations pertaining to the installation and use of this product.

#### **Site Rescue Plan**

Owners and operators must have devised an emergency rescue plan for any climber in distress at all sites operating TRUBLUE iQ Auto Belay devices. Operators must inform Users of the Auto Belay of the procedure for rescuing a climber in distress prior to climbing.

## 1.0 SAFETY INFORMATION

### 1.1 Symbols Used in this Manual

The following safety symbols are used throughout this Manual to highlight potential dangers. One or more precautions may be associated with practices and procedures described within this Manual. Failure to adhere to any precautions highlighted can result in death, serious injury, or equipment damage.

Ensure that you read and understand all safety procedures related to the working environment and the task you are performing.



#### **DANGER**

Indicates a hazardous situation exists that, if not avoided, will result in serious injury or death.

---



#### **WARNING**

Indicates a potentially hazardous situation that, if not avoided, could result in serious injury or death.

---



#### **CAUTION**

Indicates a potentially hazardous situation that, if not avoided, may result in injury or equipment damage.

---



#### **NOTE**

Indicates an action that must be taken to ensure personal safety and prevent damage to property or equipment.

---



#### **CARE FOR THE ENVIRONMENT**

Take care to minimize impact on the environment when carrying out this procedure.

## 2.0 WARRANTY CONDITIONS

The TRUBLUE iQ Auto Belay Devices are warranted against factory defects in materials and workmanship (excluding specific Field Replaceable Wear Parts - see "Replacement Parts" section below) for a period of two (2) years from date of purchase. This Warranty applies only to the original purchaser, and is contingent upon the Owner/Operator maintaining and using the device in accordance with TRUBLUE iQ Auto Belay instructions, including the requirement to continue to maintain annual recertification as described in this Operator Manual. This Warranty is in lieu of all other warranties, express or implied.

The sole remedy for breach of this Warranty, or for any claim in negligence or strict liability in tort, is the repair or replacement of any defective parts by Head Rush Technologies (Manufacturer). Upon notice in writing, Head Rush Technologies will promptly repair or replace all defective items. Head Rush Technologies reserves the right to have any defective equipment returned to its facility, transportation pre-paid, for inspection before making a repair or replacement.

This Warranty is null and void if parts other than genuine parts are used, or if any modifications or services have been performed on the device by anyone other than an authorized Head Rush Technologies servicing agent. This Warranty does not cover any damages resulting from abuse to the device, damage in transit, or any other damage beyond the control of Manufacturer. Head Rush Technologies makes no warranties in respect to trade accessories or component parts which are not made by Head Rush Technologies. Head Rush Technologies expressly excludes from this Warranty the replacement of specific Field Replaceable Wear Parts (see "Replacement Parts" below) which include the Nozzle, the webbing (line) kit, connectors and/or any anchors supplied with the product.

No person, agent or Distributor is authorized to give any Warranty, other than the one herein expressed, on behalf of Head Rush Technologies, or to assume for it any liability pertaining to such products. Head Rush Technologies expressly disclaims any implied guarantee of merchantability, or claim as to whether the device is suited for a particular purpose. Purchaser agrees that Head Rush Technologies shall not be held liable to Owner/Operator for damages of any kind, including but not limited to: lost or projected profits, equipment down time, any losses considered to be caused by non-operation or servicing/recertification down time of the equipment.

### 2.1 Owner/Operator Responsibility

The following items are considered to be the responsibility of the Owner/Operator and are therefore non-reimbursable under the terms of the Warranty.

- Product installation.
- Normal maintenance, including daily, weekly and bi-annual inspections.
- Normal replacement of service items.
- Replacements required because of abuse, misuse or improper operational habits of the operator.

- 
- Field replaceable wear parts.
  - Normal deterioration due to use and exposure.
  - The installer and Owner/operator must fully understand these instructions. Any questions must be submitted in writing to Head Rush Technologies.

Adherence to the Operator Manual, Manufacturer's instructions, and advice given by authorized Head Rush service technicians is the responsibility of the owner, installer, and operator.



## 3.0 CERTIFICATION

### 3.1 Standards



#### NOTE

If the TRUBLUE iQ Auto Belay is resold outside of the country of destination, the reseller must provide instructions for use, service, maintenance and repair in the language of the country of use.

The TRUBLUE iQ Auto Belay can be used as a climbing/descent system device only in combination with other components. It shall not be deemed suitable for use until it is ensured that the entire system complies with the requirements of appropriate regional, state, and federal directives/standards.

The TRUBLUE iQ Auto Belays conform to Regulation (EU) 2016/425 and comply with the following prevailing Safety regulations:

- **AS/NZS 1891:** Industrial fall-arrest systems and devices – Part 3: Fall arrest devices
- **CSA Z259.2.3-99:** Descent Control Devices
- **EN 341: 2011 Class 1A:** Personal protective equipment against falls from a height – Descender devices
- **ANSI/ASSE Z359.4:** Safety Requirements for Assisted-Rescue and Self-Rescue Systems, Subsystems and Components.
- **EN 360:2002:** Personal protective equipment against falls from a height - Retractable type fall arresters
  - **Section 4.5:** Maximum force <6kN for 140kg capacity

#### EU Declaration of Conformity:

EU Declaration of Conformity can be downloaded at this website address:  
[www.headrushtech.com/certification-documents](http://www.headrushtech.com/certification-documents)

#### Body controlling the manufacture of this PPE:

TÜV SÜD Product Service GmbH  
Ridlerstraße 65  
80339 München, Germany

#### Notified body performing the CE type exam:

TÜV SÜD Product Service GmbH  
Ridlerstraße 65  
80339 München, Germany

## 4.0 DESCRIPTION

---

The TRUBLUE iQ Auto Belay is a controlled descent device designed specifically for use in the climbing/aerial adventure industry. The TBiQ-LT offers a maximum descent height of 12.5 m (41 ft), and the TBiQ-XL offers a maximum descent height of 20 m (65.6 ft). TRUBLUE iQ Auto Belays are suitable for user weights ranging from 10 - 140 kg (22 - 309 lbs).

The design of the TRUBLUE iQ permits simple installation and removal and incorporates an advanced self-regulating brake system and automatic line retraction. The patented magnetic braking mechanism offers users a smooth descent with a minimal variation in descent rate of both children and adults. There are no wearing parts in the brake mechanism, ensuring that reliability remains high while maintenance and operating costs are kept to a minimum.

To protect the longevity of the TRUBLUE iQ, installation, care, and use of the TRUBLUE iQ Auto Belay must be carried out in accordance with the instructions in this Manual. The theoretical lifespan of the TRUBLUE iQ Auto Belay is unlimited with proper care and performing the required annual service maintenance. For planning purposes, we recommend a planned lifespan of 15 years.

The TRUBLUE iQ is up-gradable with additional functionality. Please contact Head Rush Technologies for additional information.

## 5.0 SPECIFICATIONS

<b>MODELS</b>	TRUBLUE iQ: TBiQ-LT (12.5m) TBiQ-XL (20m)		
<b>CERTIFICATION</b>	IN ACCORDANCE WITH EN 341:2011-1A AND EN 360:2002		
<b>DIMENSIONS</b>	292 x 369 x 201 mm (11.5 x 14.5 x 7.9 in)		
<b>NET WEIGHT</b>	TBiQ-LT: 15.9kg (35lbs) TBiQ-XL: 19.0kg (41lbs)		
<b>MATERIALS</b>	CASING	Aluminum Alloy	
	INTERNAL PARTS	Zinc plated steel	
	NOZZLE	Polypropylene	
	NOZZLE INSERT	304 Stainless Steel	
	WEBBING	Polyamide/UHMWPE	
	<b>MODEL</b>	<b>MINIMUM</b>	<b>MAXIMUM</b>
<b>MOUNTING HEIGHT (NOZZLE TO GROUND)</b>	TBiQ-LT (12.5m)	4.5m (14.8 ft)	12.5m (41.0 ft)
	TBiQ-XL (20m)	12.0m (39.4 ft)	20.0m (65.6 ft)
<b>USER WEIGHT</b>	ALL MODELS	10 kg (22 lbs)	140kg (309 lbs)
<b>OPERATING TEMPERATURE</b>	ALL MODELS	-4° C (25° F)	60° C (140° F)
	ALL MODELS (DRY)	-10° C (14° F)	60° C (140° F)
<b>STORAGE TEMPERATURE</b>	ALL MODELS	-20° C (-4° F)	60° C (140° F)
<b>LANDING VELOCITY</b>	ALL MODELS	-----	2.0 m/s (6.5 ft/s)



METRIC UNITS ARE THE CONTROLLING UNITS OF MEASURE IN THIS MANUAL. IMPERIAL UNITS ARE PROVIDED AS A COURTESY AND HAVE BEEN ROUNDED. IF THE OWNER/OPERATOR/INSTALLER MUST MAKE ANY UNIT CONVERSIONS, THE METRIC UNITS SHOULD BE REFERENCED.

## 6.0 AUTO BELAY PARTS

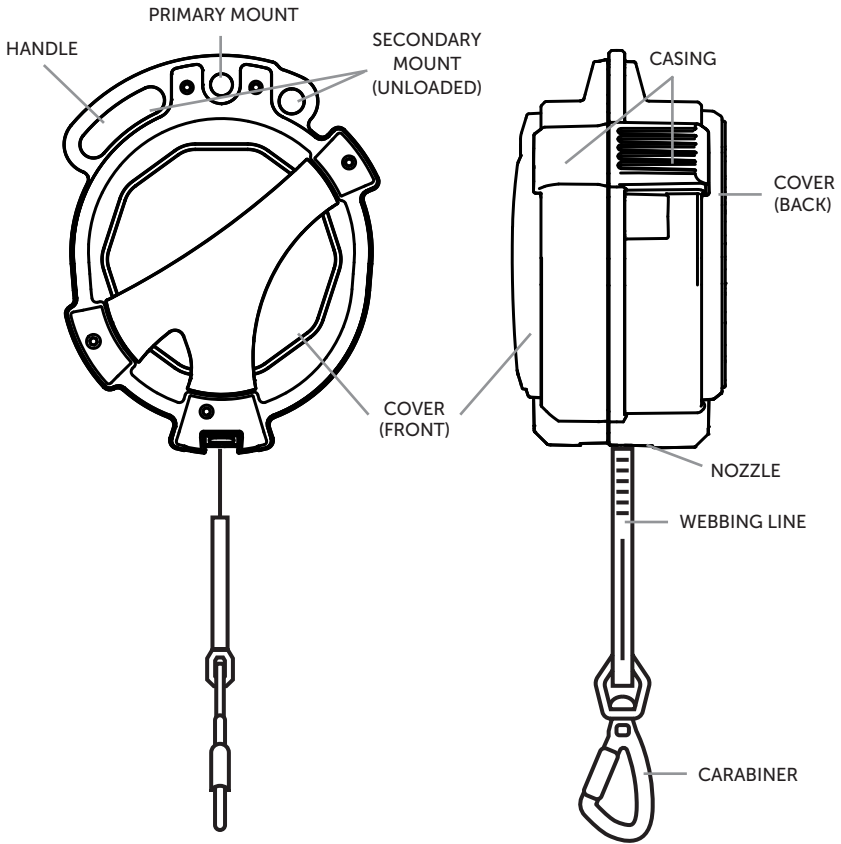

### 6.1 Label

**TBiQ-XX**

Model number

**SN iQ#####**

**SN iQXL#####**

Unit serial number

**CE0123**

Notified body  
for CE type  
examination

IN ACCORDANCE WITH EN 341:2011-1A  
AND EN 360:2002





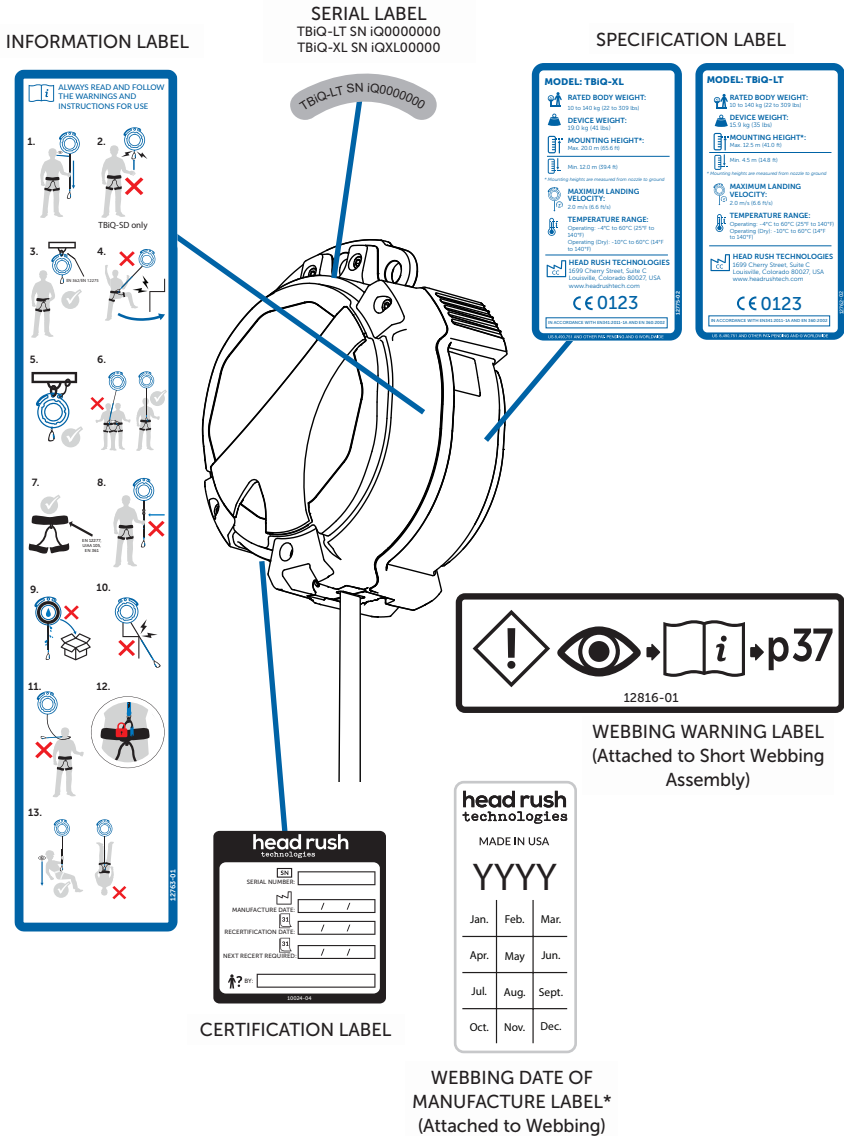



EN standard and  
device classification

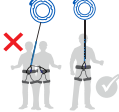

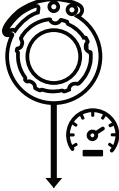
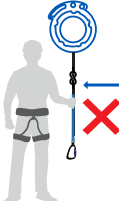

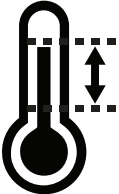
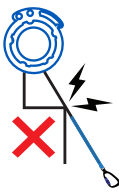

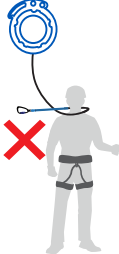



## 6.2 Location of Safety Labels

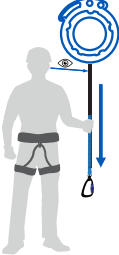
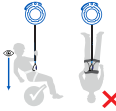
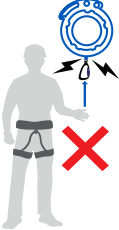

\*The date of manufacture for the webbing assembly must be recorded in the inspection log in the back of this Operator Manual. 12.5m and 20.0m webbing assemblies must be replaced after 1.5 years of usage regardless of condition.

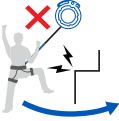
### 6.3 Icon Descriptions

	<p>Device Weight</p>		<p>Only one user at a time</p>
	<p>Body Weight</p>		<p>Harness standards</p>
	<p>Landing Velocity</p>		<p>Do not alter the line. Do not clamp, knot or tie on additional line</p>
	<p>Country of Manufacture</p>		<p>Do not store the line inside the device wet</p>
	<p>Temperature Range</p>		<p>Never install the device where the line passes over sharp edges, high friction areas</p>
	<p>Minimum Height</p>		<p>Never permit line to wrap around or become entangled with neck, arms, or legs</p>
		<p>Only compatible with TRUBLUE iQ webbing</p>	

	<p>Maximum Height</p>		<p>Connect the carabiner to the designated belay loop of your harness, making sure the gate is locked</p>
	<p>Inspect the webbing daily Check retraction before each use</p>		<p>Check descent path is clear, Always land with slightly bent knees to absorb landing</p>
	<p>Do not let TBiQ-SD (The TRUBLUE iQ Speed only) retract uncontrolled</p>		<p>Serial number</p>
	<p>Minimum connector strength for installation</p>		<p>Manufacture Date</p>
	<p>Avoid swing falls into objects</p>		<p>Date</p>
	<p>Primary connector taut, secondary back-up connector loose</p>		<p>Technician</p>

## 7.0 UNPACKING

### 7.1 Precautions



#### **LEAVE THIS OPERATOR MANUAL ATTACHED TO THE AUTO BELAY UNTIL INSTALLATION IS COMPLETE**

The Operator Manual contains information relating to the safe use of the TRUBLUE iQ Auto Belay and includes all product registration and Warranty information. The Operator Manual document may only be removed by the Owner/operator. Ensure this Manual is readily available to Auto Belay Owner/operators at all times.



#### **DO NOT DISPOSE OF PACKAGING**

The cardboard box and internal packaging are required for the return of the Auto Belay for the annual recertification. Please keep packaging in a safe place until required.

### 7.2 Receipt of the Auto Belay

The TRUBLUE iQ Auto Belay is packaged in a recycled cardboard box and contains:

- 1 x TRUBLUE iQ Auto Belay Model TBiQ-LT or TRUBLUE iQ Auto Belay Model TBiQ-XL
- 1 x 12.5 m (41 ft) or 20m (65.6ft) webbing lower line.
- 1 x Carabiner or EN 362 connector attached to the Webbing Lower Line. Some variants do not come with a connector.
- 1 x Operator Manual

### 7.3 Unpacking the Auto Belay

To unpack the Auto Belay:

1. Upon receipt of Auto Belay, inspect for signs of shipping damage or contamination. If Auto Belay shows any signs of damage or mishandling contact your Head Rush Technologies distributor.
2. Check all labels affixed to Auto Belay are present and legible.



*Do not use the Auto Belay after date shown here.*



3. Check the Certification Label for the 'Next Recertification Required' date. If the date shown has passed or the label is missing or illegible, the Auto Belay must not be put into service.
4. Register your Auto Belay online at [www.headrushtech.com/register](http://www.headrushtech.com/register).



#### **PRODUCT REGISTRATION MUST BE COMPLETED**

Product Registration is critical for receiving product notifications, recertification notices, and up-to-date information for the safe use of the TRUBLUE iQ Auto Belay. Registration is fast and easy and can be done online at [www.headrushtech.com/register](http://www.headrushtech.com/register).

5. Read the Operator Manual and familiarize yourself with all aspects of installation, operation, care and maintenance.

## **7.4 Storage**

If the Auto Belay is to be left unused for longer than two weeks, ensure the unit is clean and dry and line is fully retracted into the unit.

When returning the Auto Belay to duty after an extended period of inactivity, always carry out a full inspection and operational check.



#### **DO NOT STORE IN WET CONDITION**

After exposure to water or damp conditions thoroughly clean and dry the Auto Belay. Ensure Auto Belay is not left with wet webbing line retracted inside the casing for long periods (longer than 1 week). If the webbing is wet and the device is to be stored, remove the Nozzle and pull all the webbing out until the shackle is exposed. Insert a pin through the line to prevent retraction, and allow the webbing to dry naturally away from open fire or heat source.

Always store in a clean and dry environment.

## 8.0 INSTALLATION

### 8.1 Precautions



#### **ALWAYS USE DESIGNATED MOUNTING POINTS**

Never install the Auto Belay using any part of the device apart from the designated mounting points. Incorrect mounting can result in serious injury or death.

---



#### **ALWAYS USE THE CORRECT MOUNTING HEIGHT**

Failure to install the device at the correct mounting height could result in damage to the device or loss in device performance.

---



#### **HARD IMPACTS MAY RESULT IN STRUCTURAL DAMAGE**

Dropping of, or hard impacts to, the Auto Belay can result in serious damage to mounting points and internal parts and may compromise safety of operation. If the Auto Belay is subject to a hard impact, remove it from duty and return to a service agent for inspection.

---



#### **HEAVY ITEM - TBIQ-LT: 15.9KG (35LBS) TBIQ-XL: 19.0KG (41LBS)**

Take care when lifting the Auto Belay. Take care not to drop the device as this may result in serious injury or equipment damage.

---



#### **ALWAYS MOUNT VERTICALLY**

Always mount the Auto Belay vertically with the Nozzle pointing downwards and the line exiting the bottom of the device. Failure to do so will result in incorrect operation and compromise User safety.

---



#### **HARMFUL CONTACT**

Do not allow solvents, acids, sharp edges etc. to get into contact with the device, especially the webbing. If this occurs, the Auto Belay must be inspected.

---

### 8.2 Standards

Prior to installation, all Operators must be familiar with the requirements of all relevant Standards for anchor points, hardware, and equipment used with the Auto Belay.

#### 8.2.1 ANCHOR POINTS

All anchor points and connectors used with a TRUBLUE iQ Auto Belay must conform to any federal or state requirements for such devices.

Head Rush Technologies requires anchor points to have a minimum load capacity of 10 kN (2200 lbs) in expected directions of application. Other national and international standards for anchor points may apply and require higher load capacity. Consult with the authority having jurisdiction for your required load capacity.

The location and anchor points for the TRUBLUE iQ Auto Belay should comply with the following:

- Anchor points are not to be used by additional devices or as attachments for hardware not associated with the Auto Belay installation.
- Anchor points should be of a suitable size to correctly install any mounting hardware.

### **8.2.2 HARNESSES**

All harnesses used in conjunction with the TRUBLUE iQ Auto Belay must be of the correct size and fit, be in serviceable condition, and comply with one of the following standards:

- EN 361 - Personal protective equipment for prevention of falls from a height – Full body harness.
- EN 813 - Personal protective equipment for prevention of falls from a height – Sit harness.
- EN 12277 - Type A. Full Body Harness.
- EN 12277 - Type B. Small Full Body Harness.
- EN 12277 - Type C Sit Harness.

### **8.2.3 SECONDARY CONNECTORS**

All secondary connectors and hardware used in the installation of the TRUBLUE iQ Auto Belay must conform to the requirements of:

- EN 362 - Types of connectors for personal protection.
- EN 12275 - Types of connectors for mountaineering.

All connectors, hooks, D-rings and shackles used to mount the TRUBLUE iQ Auto Belay must be of compatible size, shape and strength for the mounting point to which they are attached.

### **8.2.4 SELECTING A LOCATION**

The TRUBLUE iQ Auto Belay is to be mounted at the top of the climbing route/descent path with the Nozzle and webbing line pointed down.

When selecting a location to mount the Auto Belay, ensure that:

- The Auto Belay will hang vertically over the climbing route with the Nozzle pointing down.
- All paths that can be encountered by the User when connected to the Auto Belay are free of sharp edges and high-friction surfaces that may damage the webbing line.
- Ensure that the descent path and landing area are free of other people or obstacles that may cause entanglement or restrict the user's ascent or descent.
- The Auto Belay is free to pivot in all directions and should not bind the mountings or be able to impact upon the surrounding structure.

### 8.2.5 OUTDOOR INSTALLATIONS

The TRUBLUE iQ Auto Belay may be installed outdoors.

It is recommended that in wet or high-variable temperature environments, the Auto Belay is protected from the direct ingress of water or foreign objects.



#### NOTE

Prolonged exposure to the elements will increase the risk of internal corrosion and degradation of the webbing line, resulting in increased operation and servicing costs. Increased inspections are required in these types of environments.

Outdoor installations in high UV, wind, and sand will require more frequent webbing replacements as these elements will artificially age the webbing and reduce its strength over time. We recommend storing the webbing inside the device when not in use and replacing the webbing every 6 months as a precaution.

### 8.2.6 MOUNTING POINTS



#### USE ONLY THE DESIGNATED MOUNTING POINTS

Use only the correct mounting points. Use of incorrect points can result in equipment damage.

Ensure all mounting hardware is secure but free to pivot in mounting point.

Ensure the mounting insert is used with the connector to reduce wear on the mounting point.

The TRUBLUE iQ Auto Belay is manufactured with a: single central pivot mounting point, an offset mounting point, and formed handle located at the top of the casing. These mounting points are located to ensure the unit hangs centrally and vertically with the line Nozzle pointing down.

The Side Covers are a sacrificial protective cover designed to prevent damage to both the device and any adjacent surface. Should the Covers become excessively worn, damaged, or aesthetically unpleasing, they may be replaced by the Owner/operator. Details of replacement parts may be found in the Replacement Parts section of this Manual.

For improved life of the plastic covers, the rounded plastic cover with the gray sash should be facing away from the climbing/descent wall. The flat plastic cover should be facing the wall. The flat plastic cover has been designed specifically to be more durable for impacts with the climbing/descent wall surface caused by natural movements of the Auto Belay while users are attached to the Auto Belay.

Install the Auto Belay by using the central mounting point, as shown below, with a longer, non-loaded secondary mount utilizing the offset mount or handle mounting points. Only use the central mounting point as shown. Ensure mounting hardware is secure and the unit is free to pivot in all directions.

The TRUBLUE iQ has a plastic mounting insert which is inserted through the primary mount attachment point. The mounting connector or carabiner should always be used with the plastic mounting insert during installation. This plastic mounting insert is designed to protect the aluminum mounting point from deformation due to swinging and movement of the Auto Belay during use. If your mounting insert becomes broken or lost, replacement mounting inserts are available from Head Rush Technologies.

Other mounting options are available. Contact Head Rush Technologies for more information.

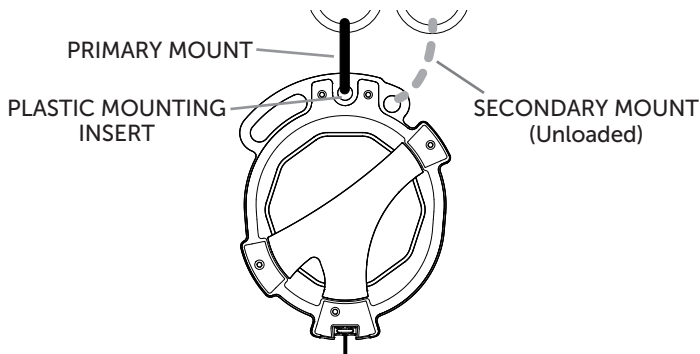

### 8.2.7 ORIENTATION

Always mount the Auto Belay with the covers parallel to the face of the climbing wall. Mounting in this direction will allow the Auto Belay to swing laterally and minimize the wear on the webbing line, Nozzle assembly and mounting points.

The flat cover should be mounted facing the climbing wall. The rounded plastic cover with the gray sash should be facing away from the climbing wall.

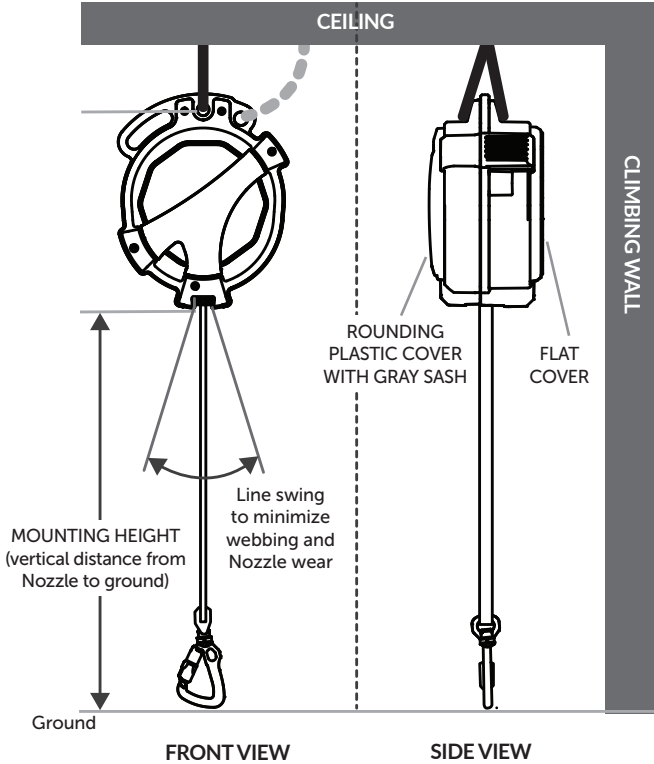

*Mounting Dimensions*

## 9.0 OPERATION

Owner/operators of the TRUBLUE iQ Auto Belay are responsible for the safety and training of any person using this equipment and owners are required by the Manufacturer to read, understand and follow all instructions in this Operator Manual regarding the correct installation and operation of the Auto Belay prior to any use.



### UNSAFE OPERATION

Remove Auto Belay from service immediately if there is any concern over its correct operation or for user safety.

Do not return Auto Belay to service until it has been inspected and completed a recertification inspection and tested by an approved Head Rush Technologies Service Agent.



### EMERGENCY RESPONSE PLAN

Owners and operators must have devised an emergency rescue plan for any user in distress at all sites operating TRUBLUE iQ Auto Belay Devices. Operators must inform users of the Auto Belay of the procedure for rescuing a user in distress prior to use.



### STOP USE IMMEDIATELY IF ANY OF THE FOLLOWING OCCUR:

- Excessively fast webbing wear is noticed. Check unit mounting and replace webbing. Place the device back in service and check that fast webbing wear is resolved.
- The descent speed increases from its normal level. Wait for the device to cool down. Place the device back in service and check if descent speed has returned to its normal level.
- The device stops retracting webbing. Send the unit in for service.



### ITEMS PREVENTING RETRACTION

Any device that fails to retract or keep pace with the user must be removed immediately from service and diagnosed by the Owner/operator. If items external to the device (see below for examples) are responsible for retraction problems, these must be corrected before placing the TRUBLUE iQ device back into service. If items external to the device have been removed, and retraction problems persist, contact the nearest authorized Head Rush Technologies service center.

Examples of external items that could prevent or affect retraction of a TRUBLUE iQ device:

- Foreign objects becoming lodged in the Nozzle.
- Route marking tape interfering with the webbing and/or becoming lodged in the Nozzle.
- Protruding handholds, climbing wall features or climbing equipment interfering with lanyard retraction.

## 9.1 Operator Training

All personnel involved in the operation of the Auto Belay must be trained and deemed competent in the following aspects of TRUBLUE iQ Auto Belay operation:

- Transportation and storage.
- Installation, use of attachment points, attachment methods and hardware.
- Inspection, cleaning, and scheduled servicing of the Auto Belay, its component parts and associated attachment hardware.
- All requirements of participant training.
- Daily webbing inspection and replacement.

## 9.2 User Instruction



### **NEVER USE WITHOUT BEING CORRECTLY ATTACHED**

Ensure the connector is attached to the belay loop of the harness or other approved anchor point and the latch is fully closed and the gate engaged before using. A gate check must be performed after every connection.

Failure to do so can result in serious injury or death.

---



### **WARNING**

Climbing is considered a strenuous activity. If you have any physical or medical conditions that may affect your climbing ability consult a medical professional prior to participation.

---



### **POTENTIAL FOR PARTICIPANT ENTANGLEMENT**

Potential for participant entanglement exists during descent. Ensure all loose items that may become tangled are tightened or removed before using the Auto Belay. A risk assessment should be completed at the installation site to determine the necessary PPE for users, such as type and brand of harness, use of helmets, etc.

Prior to clipping in, all users must be instructed in the safe use of the Auto Belay. Operators are to ensure all users are familiar with the site rescue plan in the event the user becomes distressed.



Prior to using, the user must be trained by the owner/operator and completely understand the following precautions:

- Check Auto Belay operation by pulling out a short section and allowing it to retract.
  - If the Auto Belay line fails to retract, do not clip into the Auto Belay and request assistance.
  - If the Auto Belay stops retracting for any reason while attached, STOP CLIMBING. If there is little to no slack in the line, apply your bodyweight onto the webbing and the Auto Belay will descend. Notify the operator immediately.
- Check the harness is correctly fitted and tightened.
- Check the connector from the Auto Belay line is connected to the designated loop on the harness and the gate is properly closed.
- Ensure the carabiner gate is facing away from the user.
- Never start descent from above the Auto Belay.
- Prior to descent, ensure descent path and landing area are free of people and obstructions.
- Avoid swinging while descending.
- Always descend feet first using feet to fend off obstacles and prepare for landing.
- After using, reattach the connector to an appropriate connection point at the bottom of the wall.

## 9.3 Harness

---



### **USE AN APPROVED HARNESS**

Always use a harness complying with the standards specified in this Manual. Ensure the harness is appropriate for use, in a serviceable condition and correctly fitted. Always follow the harness Manufacturer's instructions for fit, care and use.

---

## 9.4 Carabiner Use

On some models, a triple locking self closing carabiner is supplied as an integral part of the descent line. The carabiner must be checked and be in serviceable condition before any use. Ensure the carabiner is only loaded along its vertical direction.



## NOTE

If the integral carabiner is damaged or unserviceable, the complete descent line must be replaced. Use only genuine TRUBLUE iQ replacement parts.

### 9.4.1 OPERATION

Triple locking carabiners are opened by sliding the gate down, rotating the gate's collar and pushing the gate open towards the spine of the carabiner.

- Attach the carabiner to the correct loop on the harness with the gate facing away from the user.
- Allow the gate to snap shut, ensuring the collar has rotated back and is locked. Ensure that no clothing, webbing or other objects are obstructing the gate.
- Double check that the gate is secure.

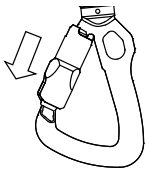

Step 1 – Slide

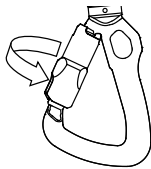

Step 2 - Twist

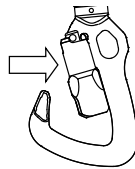

Step 3 – Depress

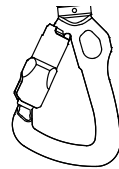

Step 4 – Release

*Carabiner Operation*

The connector must be inspected and operated in accordance with the connectors Operator Manual. Other connectors are available and should be operated in accordance with their individual manuals.

### 9.4.2 SECONDARY CONNECTIONS TO THE HARNESS

A secondary connector may be used with the TRUBLUE iQ. It is the responsibility of the operator to determine if a secondary connector is required for use.

Head Rush Technologies offers several options for secondary connectors, or continuous connection systems.

# 10.0 INSPECTION & MAINTENANCE

## 10.1 Annual Recertification



### DO NOT OPERATE AFTER THE DATE SHOWN ON THE CERTIFICATION LABEL

Operation of a TRUBLUE iQ Auto Belay without a current Certification Label visible is strictly forbidden. Severe bodily injury or death could occur.

The TRUBLUE iQ Auto Belay requires an annual recertification to be carried out by an authorized Head Rush Technologies service agent.

The Certification expiration date is shown on the Certification Label located on the side of the housing. Dismount the Auto Belay and return to an Authorized Service Center prior to the expiration date.

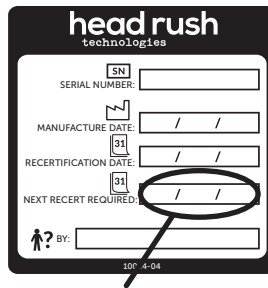

*Do not use the Auto Belay after date shown here.*

## 10.2 Scheduled Maintenance

The following inspection and service actions must be carried out by the operator or operator-trained staff. All personnel performing these actions must be trained in the correct procedures and deemed competent to do so.



### NO UNAUTHORIZED SERVICING

Do not attempt to carry out any maintenance, repair or service actions not detailed in the Operator Manual.

Any unauthorized maintenance, repair or modifications to the Auto Belay will compromise safety, render the unit not fit for use, and void the Warranty provisions.



#### **NOTE**

Service in a clean environment. If the Auto Belay has been removed from its operational location for service, ensure that the service area is clean and free from contaminants.

Ensure unit is securely placed on a sturdy work table and that side covers are not subject to damage.

---

### **10.2.1 SAFETY PRECAUTIONS**



**HEAVY OBJECT – TBiQ-LT: 15.9kg (35lbs)**

**TBiQ-XL: 19.0kg (41lbs)**

Ensure the Auto Belay device is secured during service to prevent accidental damage or injury from dropping.



#### **CAUTION – SPRING LOADED PARTS**

The webbing assembly is spring loaded and will rapidly return into the device if released. This may result in damage or injury.



#### **MAGNETIC PARTS**

The Auto Belay contains strong magnets. Always ensure working environment is free of loose ferrous materials. Ingress of metal objects may compromise Auto Belay operation. The TRUBLUE iQ conforms to all standards regarding magnetic health safety of magnetic flux power next to the device with the plastic side covers installed. This limit has been established as safe for medical devices on and in the human body.

## **10.3 Daily Inspection**

The daily webbing inspection must include at least a visual inspection sufficient to evaluate the wear and integrity of the device's webbing. Please see "Webbing Wear" below for a detailed description of when a webbing should be taken out of service. The inspection may be performed while the unit is mounted if the webbing can be adequately inspected.

## **10.4 Weekly Inspection**

The TRUBLUE iQ Auto Belay must be inspected weekly for correct operation and overall condition. The weekly inspection may be carried out with the unit in place or removed to a sturdy work table. The weekly inspection and the 6 month inspection must be recorded in the inspection log at the back of this Manual.

## 10.4.1 INSPECTION PROCEDURE

Ensure adequate lighting and unrestricted access is available to permit a thorough inspection of all areas of the Auto Belay. This inspection should be completed either with the Auto Belay dismounted or by climbing to the location of the Auto Belay and anchoring in, so you may visually inspect the unit and the entire length of webbing.

1. Clean any dust, dirt or contamination off the casing and fittings with a clean cloth.



### DO NOT USE SOLVENTS OR ABRASIVES

Clean with a cloth only. Do not use any cleaners, solvents or abrasives on any part of the Auto Belay or its associated equipment. Contact Head Rush Technologies for any questions regarding disinfecting the Auto Belay or the webbing components.

---

2. Visually inspect the casing, mounting holes, plastic mounting insert, and plastic covers for wear, impact damage, cracking, deformation, and corrosion. Replace any damaged items or remove Auto Belay from service.
3. Check all safety labels are in place and in good condition.
4. Check that the date on Certification Label is current.
5. Inspect the condition of the connector, checking for:
  - Wear and damage that could affect the strength of the connector.
  - Correct operation of the locking mechanism.
  - Smooth operation of the swivel.

If the connector or swivel does not automatically lock or rotate, the connector can be washed with soap and water and allowed to air dry. Then lubricate per the connector Manufacturer's recommendations, which include a dry, wax-based or PTFE-based lubricant, until fully operational. If full functionality cannot be restored, replace the entire webbing assembly.

6. Slowly pull out the entire length of webbing from the unit. As webbing is withdrawn, inspect for:
  - Damage, cuts, or abrasion to stitching.
  - Cutting, wear, and abrasion to the surface of webbing.
  - Discoloration, fading on the surface.
  - Heat and friction damage such as hard or shiny areas.
  - Contamination from dirt or chemicals.
  - Twisting or knotting.

Replace webbing if any signs of wear or damage are present that resemble the replacement criteria photos.

7. Allow the webbing to slowly retract into the unit – checking the retraction action is strong and smooth. Sharply tug at the webbing every 1-2 meters, to cinch down the webbing stack.
8. Complete and file 'Weekly Inspection Log' documentation.
9. Return Auto Belay device to service.

#### 10.4.2 WEBBING WEAR



##### INSPECT WEBBING DAILY

Webbing in your TRUBLUE iQ must be evaluated on a daily basis. A detailed description of when a webbing should be taken out of service is included in the Wear Tables below. Webbing **MUST** be taken out of service according to its condition relative to the stage of wear designated in the Wear Tables. It is recommended that webbing be replaced after 1.5 years of usage regardless of wear. The date of manufacture of the webbing is located on the webbing tag inside the device near the shackle. The date of manufacture of the webbing **MUST** be recorded in the inspection log. Continued use of webbing with wear at or beyond the designated stage of wear below could result in serious injury or death.

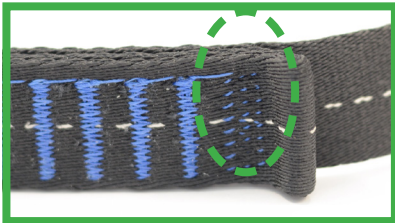









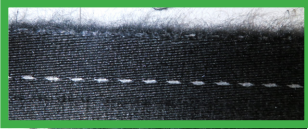

The structural stitch pattern includes a sacrificial bumper stitch pattern which protects the structural bar tack stitches. See highlighted section for bumper stitches. These stitches are allowed to unravel over time due to impacts with the Nozzle. Trim any loose threads in this section. When this section is completely unraveled over time, the entire webbing assembly must be replaced.

## WEAR TABLES

Webbing pictures outlined in **red** in the tables below show webbing that **MUST** be taken out of service and replaced immediately to continue using your TRUBLUE iQ.

### TRUBLUE iQ

Edge and Face Wear		Progress of Bumper Stitch Separation	
Edge Wear Monitor		Monitor	
Edge Wear Monitor		Monitor	
Face Wear Replace		Monitor	
Edge Wear Replace		Monitor	
Edge Wear Replace		Replace	

#### MOLDY WEBBING

Any webbing showing signs of mold should be taken out of service.

#### UV EXPOSURE

Webbing used outdoors in direct sunlight for extended periods of time should be replaced more frequently. Recommend at least every 6 months.

## TROUBLESHOOTING WEBBING WEAR

Symptoms	Potential Causes	Potential Solutions
<b>BUMPER STITCH DEPLOYED</b>	Unit mounted low	Mount the unit higher or develop routes that minimize the impact of the bumper stitch on the Nozzle at the finish of the climb.
	Normal use of the TRUBLUE iQ	The bumper stitch is designed to absorb impacts with the Nozzle. Over time, these impacts will bend the webbing and slowly pull out the stitches. Trim any loose threads. If the bumper stitch is completely unraveled, the webbing assembly must be replaced.
<b>WEBBING FACE WEAR</b>	Webbing is rubbing on the wall (overhang or corner of wall)	Move the TRUBLUE iQ so the webbing does not rub on the wall/corner.
	<b>SIDE WEAR</b> Webbing is rubbing on a hold	Look for problem holds. Move the hold. Do not place large holds immediately below TRUBLUE iQ.
<b>LOOP FAILURE &amp; HAND GRIP WEAR</b>	Foreign objects, including dirt and/or dust have introduced damage to webbing assembly	Make sure to cover the TRUBLUE iQ when not in use. Wipe the webbing with a dry cloth daily, after use.
	Normal use of TRUBLUE iQ	Parts and webbing wear over time with normal operation, replace webbing as necessary.
<b>BAR TACK DAMAGED</b>	Climbers are rubbing the bartack on holds or the wall	Monitor routes with the TRUBLUE iQ to minimize contact with holds or wall features while climbing.
<b>UV FADED WEBBING</b>	Sun is damaging webbing	Remove TRUBLUE iQ at the end of day or cover unit and webbing after use. Allow webbing to retract into the device when not in use.
<b>HAND GRIP WEAR</b>	Hand grip is rubbing against wall/holds	Look for problem holds. Move the hold.
	Normal use of TRUBLUE iQ	Parts and webbing wear over time with normal operation, replace webbing as necessary.
<b>WEBBING IS MOLDY/ DISCOLORED</b>	Webbing is not being dried after being used in wet conditions	Whenever using the TRUBLUE iQ in wet conditions, take the unit down at the end of the day, extend the webbing in a sanitary environment, and allow webbing to dry outside of the unit.



## 10.5 Six Month Inspection

The TRUBLUE iQ Auto Belay requires an in-depth six (6) month inspection by the Owner/operator. For the six month inspections the unit must be dismounted and removed to a sturdy work table.

### 10.5.1 INSPECTION PROCEDURE

1. Dismount the Auto Belay (refer to Installation Instructions).
2. Clean Auto Belay using a clean cloth.
3. Carry out Steps 1 through 6 of the 'Weekly Inspection'.
4. Remove the Nozzle – Refer to **"To remove the Nozzle assembly"** section below.
5. Inspect Nozzle Assembly for the following:
  - Excessive wear to slot, which could affect retraction of the webbing.
  - Splitting, cracking and deformation.
  - Correct fit in housing.

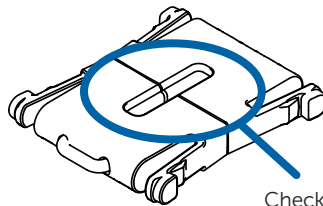

*Nozzle Wear*

Check Nozzle for excessive wear around slot

### 10.5.2 WEBBING INSPECTION

1. With Nozzle assembly removed, pull out the complete webbing line, including approx. 100 mm (4 in) of the short webbing loop.
  - Twist the webbing 90 degrees, then place a suitable pin through the loop in the short webbing loop, above the joining link to prevent it retracting back into the unit.
2. Inspect the webbing line by passing the webbing slowly through your hands under a good light. Inspect the webbing for:
  - Damage to stitching (cuts or abrasion).
  - Cuts to webbing, especially to edges.
  - Abrasion across the surface of the webbing, wear and fraying, especially to the edges.

- UV degradation – although difficult to detect, visual indications are discoloration, and fading of the webbing surface. The webbing will also become very soft. Consider replacement.
- Chemical attack, this can result in soft or weak fibers, color change or flaking of the surface.
- Heat or friction damage, indicated by hard fibers or glazing of the surface.
- Contamination from dirt, grit, sand, or rust.
- Twisting, knotting, or permanent deformation of webbing.

Replace the webbing if any signs of damage or deterioration are present.

3. Inspect the webbing joining shackle. Ensuring that:

- The shackle pin is secure and straight – do not attempt to tighten or loosen.



**NOTE**

The shackle pin is secured with thread locking compound and any attempt to turn will compromise its security.

- The shackle is undamaged and in the correct orientation.
- The webbing around the link is not worn or damaged.



*Webbing Retaining Pin*

4. Remove the pin, untwist the webbing 90 degrees, and allow the upper line to slowly retract into the unit. Inspect the webbing as it retracts and ensure that the webbing line does not twist.
5. Refit the Nozzle assembly – Refer to **“To refit the Nozzle assembly”** section.
6. Complete the “Six Month Inspection” documentation.
7. Return Auto Belay to service.

## 10.6 Nozzle Replacement

If the Nozzle assembly shows signs of excessive wear that could impede retraction of the webbing, damage, or poor fit it must be replaced.



**USE ONLY GENUINE TRUBLUE iQ REPLACEMENT PARTS**



**ALWAYS REPLACE NOZZLE AS A PAIR**

If Nozzle requires replacement, always replace as a matched pair – do not mix worn and new Nozzle pieces.

### To remove the Nozzle assembly:

1. Place the Auto Belay unit with the flat plastic cover side down taking care not to damage the plastic side covers - Ensure it is secure and cannot fall.
2. Pull out the Nozzle Pin.
3. Pull out all the webbing. The short webbing assembly will push the two Nozzle halves out. Twist the webbing 90 degrees and pin the webbing.
4. Slightly twist each Nozzle halve to release from the housing tab slot.



Assembled Nozzle



Step 2 - Remove pin



Step 3 - Pull out webbing



Step 4 - Pin Short Webbing Assembly

### Refit the Nozzle assembly:

1. Refit the lower half of the Nozzle assembly into the recess on the casing.
2. Fit the upper half of the Nozzle assembly.

3. Remove the pin and untwist the webbing 90 degrees. Allow the webbing to slowly retract, and push the two Nozzle halves closed. Retract the webbing back into the device, tugging on the webbing every 1-2 meters to properly seat the webbing.
4. Replace the pin through both Nozzle halves.
5. Check Auto Belay for correct operation.

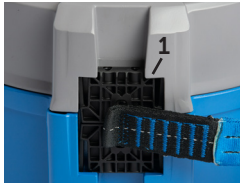

Step 1 – Fit top half

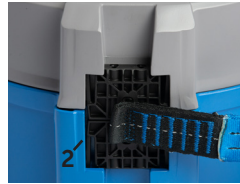

Step 2 – Fit bottom half



Step 3 – Fit pin



Assembled Nozzle

## 10.7 Webbing Line Replacement

If the webbing line shows signs of wear, damage, or contamination then it will need to be replaced. The short webbing loop inside the device does not receive wear under normal operation and is not inspectable by the operator. Replace Line as follows:

### 10.7.1 SAFETY PRECAUTIONS



#### **DO NOT ALLOW SHORT WEBBING LOOP TO RETRACT INTO HOUSING**

With Nozzle removed take care to not permit uncontrolled retraction of short webbing loop into unit. Uncontrolled retraction will result in internal damage and require repair by the Manufacturer.



#### **USE ONLY GENUINE TRUBLUE iQ REPLACEMENT PARTS**

The TBiQ-LT must use the 12.5M webbing. There is a blue tag near the bartack with "12.5M". The TBiQ-XL must use the 20.0M webbing. There is a purple tag near the bartack with "20M".

## 10.7.2 WEBBING LINE REPLACEMENT PROCEDURE

### To replace the webbing line:

1. Remove the Auto Belay from service.
2. Remove the Nozzle assembly – Refer **“To Remove Nozzle Assembly”** above.
3. While holding Auto Belay securely, pull out the webbing line until the end of the short webbing loop and the joining shackle are exposed.
4. Locate the loop in the short webbing loop, approx. 150 mm (6 in) past the shackle. Twist webbing 90 degrees and place the Nozzle Assembly pin through the loop in the short webbing loop to prevent it retracting back inside the casing.

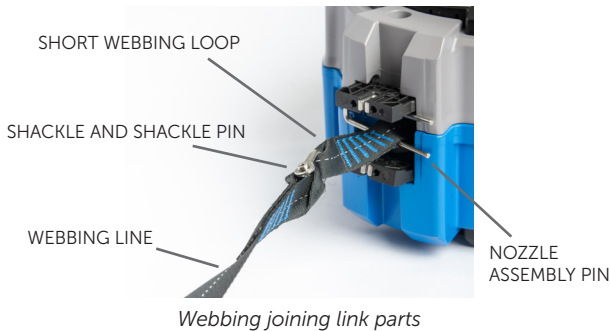

5. Unscrew the shackle pin.
6. Remove webbing and shackle pin from the short webbing loop.
7. Ensure the loop part of the shackle is fitted to the short webbing loop.



### THREAD LOCKING COMPOUND

Ensure the factory applied thread locking compound is present on the shackle pin threads. Do not reuse the Shackle Pin.



### WARNING

The TRUBLUE iQ can only use TRUBLUE iQ webbing. Do not use original TRUBLUE webbing, or any webbing from any other manufacture. Incompatible webbing may result in severe injury or death if used. The TRUBLUE iQ webbing has a white yarn down the center and is sold by authorized Head Rush Technologies locations.

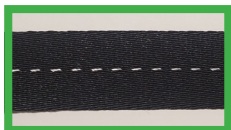

- Fit the new webbing line, passing the threaded shackle pin through the loop as shown below.



*Correct shackle fit*

- Tighten the shackle pin to hand tight, ensuring the threads are fully engaged and the end of the pin is flush with the joining shackle as shown.
- Remove the holding pin, untwist the webbing 90 degrees, and allow the new line to slowly retract until short webbing loop and joining link is inside casing. Ensuring that the webbing line does not twist.



Once shackle pin is tightened, it must not be loosened or re-tightened. This will break the locking compound and the shackle pin may become loose. The shackle pin must be replaced if this happens.



Ensure that the webbing line feeds squarely and without twists when retracting back into the auto belay.

Failure to do so may result in equipment failure, serious injury or death to participants.

- Refit Nozzle assembly – Refer to **“Refit the Nozzle assembly”** section above.
- Slowly retract the webbing line into the casing, checking the action is smooth and adequate spring resistance is felt. Sharply tug on the webbing every 1-2m to cinch down the webbing onto the stack.
- Once line is fully retracted, pull out line a short distance using reasonable force and allow it to retract. Repeat two to three times to ensure line is firmly wound onto the drum.
- Return Auto Belay to service and check for correct retraction and descent.

## 10.8 Replacement Parts

Your TRUBLUE iQ Auto Belay is fitted with a number of replaceable parts that may be refitted without the need to return the device to an authorized Head Rush Technologies service agent. Always follow the Manufacturer's instructions as detailed in this Operator Manual and any Part Replacement Guide supplied when undertaking replacement of a part.

**TRUBLUE iQ Replaceable Components**

Part Number	Name
12790	TRUBLUE iQ Replacement Webbing, 12.5m, TRU-Lock Aluminum carabiner
12791	TRUBLUE iQ Replacement Webbing, 12.5m, Adventure webbing
12792	TRUBLUE iQ Replacement Webbing, 12.5m, Open Loop (no connector)
12793	TRUBLUE iQ Replacement Webbing, 20m, TRU-Lock Aluminum carabiner
12794	TRUBLUE iQ Replacement Webbing, 20m, Adventure webbing
12795	TRUBLUE iQ Replacement Webbing, 20m, Open Loop
12796	TRUBLUE iQ Replacement Webbing, 12.5m, Steel Swivel Carabiner
12797	TRUBLUE iQ Replacement Webbing, 20m, Steel Swivel Carabiner
12755	TRUBLUE iQ Replacement Mounting Insert
12532	TRUBLUE iQ Replacement Front Cover
12511	TRUBLUE iQ Replacement Back Cover
12813	TRUBLUE iQ Replacement Nozzle Assembly
12811	TRUBLUE iQ Replacement Shipping Box
12797	TRUBLUE iQ Replacement Shipping Box Insert



### NOTE

For optimal performance of your TRUBLUE iQ Auto Belay, only use genuine TRUBLUE iQ parts and accessories.

To order replacement parts or accessories, contact your authorized Head Rush Technologies service agent or go to [www.headrushtech.com](http://www.headrushtech.com).

## 10.9 Troubleshooting

Refer to troubleshooting instructions or contact your authorized Head Rush Technologies service agent.

## 10.10 Transportation

To ensure safe shipment of your auto belay, it should only be shipped in authorized TRUBLUE iQ packaging (box and packing material). If you have misplaced your original packaging, purchase replacement packaging from an authorized Head Rush Technologies service agent, or online at [www.headrushtech.com](http://www.headrushtech.com). You will be responsible for the cost of any damage and necessary repairs due to shipping your auto belay in unauthorized packaging.



### CARE FOR THE ENVIRONMENT

Reuse the original packaging when shipping Auto Belay.

---

## 10.11 Upgrades

The TRUBLUE iQ has a patent pending interface which allows for future upgrades. These upgrades will provide additional functions and features for your Auto Belay. All upgrades once available will be listed at [www.headrushtech.com](http://www.headrushtech.com). Authorized service centers will be able to assist with any future upgrades for your TRUBLUE iQ Auto Belay.

# 11.0 MANUFACTURER'S DETAILS

For Recertification or unscheduled service or repairs, return your TRUBLUE iQ Auto Belay to your nearest Head Rush Technologies Authorized Service Center or to the Manufacturer at the address shown below.

### ADDRESS

Head Rush Technologies  
1699 Cherry Street, Suite C  
Louisville, CO 80027  
USA

### CONTACT DETAILS

+1-720-565-6885  
[www.headrushtech.com](http://www.headrushtech.com)  
[info@headrushtech.com](mailto:info@headrushtech.com)

To find a Service Center outside the U.S., visit [www.headrushtech.com/find-a-distributor](http://www.headrushtech.com/find-a-distributor).

EU importers may apply their name and address on the device to comply with government regulations next to the specification label.



## 12.0 INSPECTION LOGS

### 12.1 Weekly Inspection Log

**INSPECTION REMINDER:** A webbing inspection must be performed daily and must include at least a visual inspection sufficient to evaluate the wear and integrity of the device's webbing. The inspection may be performed from the ground if the webbing can be adequately inspected. Replace webbing if any signs of wear or damage are present according to the Wear Tables in this manual. Webbing wear documents are available at [www.headrushtech.com](http://www.headrushtech.com). Replacement webbing can be ordered from your dealer or at [www.headrushtech.com](http://www.headrushtech.com). A year from your purchase date the unit is due for recertification, which should be scheduled with an authorized service center.

This guide is provided for your convenience in keeping track of your weekly unit inspections. Operator Manuals and additional copies of the Weekly Inspection Log can be found at the following links:

Manuals:

[www.headrushtech.com/product-manuals](http://www.headrushtech.com/product-manuals)

Webbing inspection:

[www.headrushtech.com/webbing-inspection](http://www.headrushtech.com/webbing-inspection)

Webbing logs:

[www.headrushtech.com/webbing-logs](http://www.headrushtech.com/webbing-logs)

Model#

Serial #

Webbing Date of Manufacture:

Recommended Webbing Replacement Date  
(Date of First Use + 1.5yrs):

**WEEKLY INSPECTION**

**1. Visually inspect casing, mounting holes, and covers for wear, impact damage, cracking, deformation, or corrosion. Replace damaged items or remove from service.**

	JAN	FEB	MAR	APR	MAY	JUN	JUL	AUG	SEP	OCT	NOV	DEC
Week 1												
Week 2												
Week 3												
Week 4												

**2. Check all safety labels are in place and in good condition. Check that the date on certification label is current.**

	JAN	FEB	MAR	APR	MAY	JUN	JUL	AUG	SEP	OCT	NOV	DEC
Week 1												
Week 2												
Week 3												
Week 4												

**3. Check the condition of the connector for wear and damage, correct operation of the locking mechanism, and smooth operation of the connector swivel.**

	JAN	FEB	MAR	APR	MAY	JUN	JUL	AUG	SEP	OCT	NOV	DEC
Week 1												
Week 2												
Week 3												
Week 4												

**4. Slowly pull webbing from unit. Inspect for damage to stitching, cuts, wear, fraying, discoloration, and other signs of damage or contamination. Allow the webbing to slowly retract into casing, check that the retraction action is strong and smooth.**

	JAN	FEB	MAR	APR	MAY	JUN	JUL	AUG	SEP	OCT	NOV	DEC
Week 1												
Week 2												
Week 3												
Week 4												

**DO NOT USE THE DEVICE IF IT SHOWS ANY SIGNS OF DAMAGE, WEAR, OR INCORRECT OPERATION.** If any signs of damage, wear, or incorrect function exist, remove the device from duty and contact an authorized service center for servicing options.

## 12.2 Six Month Inspection Log

This guide is provided for your convenience in keeping track of your bi-annual (every 6 months) unit inspections. **Refer to the Operator Manual for in-depth instruction on how to perform outlined tasks.** The Operator Manual and additional copies of the Six Month Inspection Log can be found at [www.headrushtech.com/webbing-logs](http://www.headrushtech.com/webbing-logs).

Model #:		Serial #:		
Inspector:		Inspection Date:		
Webbing Assembly Date of Manufacture:				
ORDER/DESCRIPTION	PASS	FAIL	COMMENTS	
1			Dismount the unit (Refer to "Installation" section of Manual)	
2			Carry out 'Weekly Inspection'.	
3			Remove the Nozzle – Refer to 'Nozzle Removal' section of Manual.	
4			Inspect Nozzle Assembly for: <ul style="list-style-type: none"> <li>▪ Excessive wear to slot.</li> <li>▪ Splitting, cracking and deformation around slot and mounting flanges.</li> <li>▪ Correct fitment in housing.</li> </ul>	
5			With Nozzle assembly removed, pull out the complete webbing line, including approx. 100 mm (4 in) of the short webbing loop.	
6			Twist the webbing 90 degrees and place a suitable pin through the loop in the short webbing loop, above the joining link to prevent it retracting back into the unit.	
7			Inspect the complete webbing line for: <ul style="list-style-type: none"> <li>▪ Damage to stitching.</li> <li>▪ Cut, wear, and fraying.</li> <li>▪ Discoloration and contamination.</li> <li>▪ Any other signs of damage.</li> </ul>	

8	<p>Inspect the webbing joining shackle, ensuring that:</p> <ul style="list-style-type: none"> <li>▪ The shackle pin is secure and straight – do not attempt to tighten. (NOTE - The shackle pin is secured with thread locking compound and any attempt to turn will compromise its security.)</li> <li>▪ The shackle is undamaged and in the correct orientation.</li> <li>▪ The webbing around the link is not worn or damaged.</li> </ul>			
9	<p>Remove the pin, untwist the webbing 90 degrees, and allow the webbing to <b>slowly</b> retract into the unit cinching the webbing every 1-2 meters. Inspect the webbing as it retracts. Make sure not to introduce a twist in the webbing as it is retracting.</p>			
10	<p>Refit the Nozzle assembly.</p>			

**DO NOT USE THE DEVICE IF IT SHOWS ANY SIGNS OF DAMAGE, WEAR, OR INCORRECT OPERATION.** If any signs of damage, wear, or incorrect function exist, remove the device from duty and contact an authorized service center for servicing options.









### **REGISTER YOUR DEVICE**

Get automatic updates on recertification and product information –  
visit [www.headrushtech.com/register](http://www.headrushtech.com/register)

### **ANNUAL RECERTIFICATION IS REQUIRED**

Please keep the shipping box for your device. For instructions on annual  
recertification, visit [www.headrushtech.com/annual-service](http://www.headrushtech.com/annual-service)

+1-720-565-6885

[www.headrushtech.com](http://www.headrushtech.com)

[info@headrushtech.com](mailto:info@headrushtech.com)

October 2021