



XP8500E GENERATOR

User Manual

REV: XP8500E-07072020

This manual provides information regarding the operation and maintenance of these products. We have made every effort to ensure the accuracy of the information in this manual. We reserve the right to change this product at any time without prior notice.

5800 Ontario Mills Pkwy
Ontario, CA 91764 USA
www.duromaxpower.com

Call our Customer Care Team Toll Free 8-5pm PST Mon-Fri
844-DUROMAX



1.

Introduction

Introduction	6
General Safety Procedures	8
Unit and Purchase Information	12
Carbon Monoxide Safety	13

2.

Quick Start

Quick Start Guide	14
Generator Components	16
Package Contents	18

3.

Generator Setup

Shipping Braces	21
Wheel Kit Installation.....	22
Connect the Battery	24
Adding Oil	25
Adding Gasoline	26
Grounding the Generator	27
High Altitude Operation	27

4.

Starting the Generator

Checking the Oil	30
Check the Gas Level	31
Starting the Generator	32
Starting the Generator Using Recoil Start	34

5.

Using the Generator

AC Usage	38
Connecting a Load to the Generator.....	40
DC Usage.....	42

CONTENTS

6.

Maintenance and Care

Maintenance Schedule.....	46
Maintenance Log	47
Checking the Oil	48
Changing the Oil.....	49
Cleaning the Air Filter	50
Spark Plug Maintenance	52
Emptying the Gas Tank	54
Cleaning the Fuel Filter Cup.....	56
Storage and Transportation	57
Specifications.....	58

7.

Troubleshooting

Basic Troubleshooting	60
Changing / Inspecting the Carbon Brushes	61
Changing / Inspecting the AVR	63
Wiring Diagram	66

8.

Warranty	68
-----------------------	----

9.

Contact Information	72
----------------------------------	----





THE DUROMAX WAY

The DuroMax Way is more than just a brand, it is our understanding and appreciation of just how important power can be to someone without it...



DUROMAX FOR HOME

Electricity in our home not only provides comfort but safety as well. From keeping the heat or A/C on to keeping our food cold, power is essential to our daily lives. Inevitably when disaster strikes and we are left without power for a prolonged period of time, our way of life is put at risk. This is by far the most critical time for reliable portable power.



DUROMAX FOR WORK

On the job site, portable power allows you the ability to get work done in remote locations when traditional power sources are usually unavailable. Equipment like table saws, sanders, and work lights are a necessity and portable power can play a critical role in getting a job done successfully and efficiently.



DUROMAX FOR PLAY

Camping outdoors in a remote location can get one in touch with nature and allow them to forget the stress of the day to day grind. Here portable power can provide comfort as well as safety. With portable power, you can keep your cell phone charged, light up your campsite, or even brew a cup of coffee, all while being miles from civilization.

The DuroMax Way is a commitment to excellence. This vision is focused on the quality, reliability, and durability of our products combined with outstanding customer service. We understand that having dependable power whenever and wherever you need it provides comfort, safety, and peace of mind. It is through this philosophy that DuroMax achieves our vision of...

POWERING EVERYONE... **ANYWHERE!**

INTRODUCTION

DuroMax Power Equipment is headquartered in Ontario, California and is the industry's leader in Dual Fuel portable generator technology. In addition to a full assortment of portable generators ranging from digital inverters to large 15,000-watt portable standby units, their product line includes pressure washers, engines, pumps, and accessories.

The foundation of our company is built on quality, reliability, durability, and customer service. At DuroMax our vision is simple, we are committed to Powering Everyone... Anywhere!



Notice Regarding Emissions

Engines that are certified to comply with U.S. EPA emission regulations for SORE (Small off Road Equipment), are certified to operate on regular unleaded gasoline and may include the following emission control systems: (EM) Engine Modifications and (TWC) Three-Way Catalyst (if so equipped).

GENERAL SAFETY PROCEDURES



SAFETY ALERT SYMBOL

The safety alert symbol is used with one of the safety words (**DANGER**, **CAUTION**, or **WARNING**) to alert you of hazards. Please pay attention to these hazard notices both in this manual and on the generator.

Please familiarize yourself with the following safety symbols and words:

- **DANGER**: Indicates a hazard that will result in serious injury or death if instructions are not followed.
- **WARNING**: Indicates a strong possibility of causing serious injury or death if instructions are not followed.
- **CAUTION**: Indicates a possibility of personal injury or equipment damage if instructions are not followed.



DANGER: This generator produces poisonous carbon monoxide gas when running. This gas is both odorless and colorless. Even if you do not see or smell gas, carbon monoxide may still be present. Breathing this poison can lead to headaches, dizziness, drowsiness, and eventually death.

- Use outdoors **ONLY** in non-confined areas.
- Keep several feet of clearance on all sides to allow proper ventilation of the generator.



WARNING: The exhaust from this product contains chemicals known to the State of California to cause cancer, birth defects, or other reproductive harm.



WARNING: This generator produces heat when running. Temperatures near exhaust can exceed 150°F (65°C).

- Do not touch hot surfaces. Pay attention to warning labels on the generator denoting hot parts of the machine.
- Allow generator to cool several minutes after use before touching engine or areas which heat during use.



WARNING: This generator may emit highly flammable and explosive gasoline vapors, which can cause severe burns or even death. A nearby open flame can lead to an explosion even if not directly in contact with gasoline.

- Do not operate near an open flame.
- Do not smoke near the generator.
- Always operate on a firm, level surface.
- Always turn the generator off before refueling.
- Allow generator to cool for at least 2 minutes before removing the fuel cap. Loosen cap slowly to relieve pressure in the tank.
- Do not overfill the gas tank. Gas may expand during operation. Do not fill to the top of the tank.
- Always check for spilled gas before operating.
- Empty the gasoline tank before storing or transporting the generator.
- Before transporting, turn the fuel valve to the off position and disconnect the spark plug.



WARNING: This generator produces a powerful voltage, which can result in electrocution.

- ALWAYS ground the generator before using it (see the “Grounding the Generator” portion of the “PREPARING THE GENERATOR FOR USE section).
- The generator should only be plugged into electrical devices, either directly or with an extension cord. NEVER connect to a building electrical system without a qualified electrician. Such connections must comply with local electrical laws and codes. Failure to comply can create a back-flow of power, which may result in serious injury or death to utility workers.
- Use a ground fault circuit interrupter (GFCI) in highly conductive areas such as metal decking or steelwork. GFCIs are available in-line with some extension cords.
- Do not use uncovered in rainy or wet conditions.
- Do not touch bare wires or receptacles (outlets).
- Do not allow children or non-qualified persons to operate.

GENERAL SAFETY PROCEDURES

In addition to the above safety notices, please familiarize yourself with the safety and hazard markings on the generator.

⚠ **DANGER**





**DO NOT OVERFILL
THE GAS TANK**

**OVERFILLING CAN RESULT
IN A FIRE, EXPLOSION,
OR DEATH.**

⚠ **DANGER**

Using a generator indoors **CAN KILL YOU IN MINUTES.**
Generator exhaust contains carbon monoxide. This is a poison you cannot see or smell.

		
<p>NEVER use inside a home or garage, EVEN IF doors and windows are open.</p>		<p>Only use OUTSIDE and far away from windows, doors, and vents.</p>
<p>Avoid other generator hazards. READ MANUAL BEFORE USE</p>		





UNIT AND PURCHASE INFORMATION

Serial Number



Serial Number

The serial number is located on the engine block, above and to the left of the oil fill.



Serial number format

The serial number will be shown in two parts. The engine model, followed by the serial number.

Engine Model: _____

Serial Number: _____

STAPLE RECEIPT HERE

A purchase receipt may be necessary for warranty parts or service in the future. If you have a paper receipt staple it here for easy reference.

If you purchased the unit online, save the email receipt where you can access it, and record your details here for convenience in the future.

Purchase Date: _____

Order Number: _____

Retailer Name: _____



ALWAYS READ THE OWNER'S MANUAL FIRST

KNOW THE SYMPTOMS

- HEADACHE
- NAUSEA
- SHORTNESS OF BREATH
- DIZZINESS
- FATIGUE



IF YOU FEEL SYMPTOMS, LEAVE RIGHT AWAY

STAY ALERT WITH CARBON MONOXIDE DETECTORS

POINT FUMES AWAY FROM NEARBY PEOPLE

KEEP IT OUTSIDE AND AWAY FROM DOORS AND WINDOWS



PGMA
Portable Generator Manufacturers Association

As the only safe way to use a portable generator, taking your generator outside is absolutely mandatory to keep your family safe from carbon monoxide. But there's even more you can do. By educating yourself about all carbon monoxide risks, you'll be better prepared to protect your family from this colorless, odorless threat. Visit takeyourgeneratoroutside.com for more information.

TAKE IT OUTSIDE™



CARBON MONOXIDE KILLS

QUICK START GUIDE



1. Remove shipping braces

The shipping braces prevent engine movement during shipment. Flip the generator over and remove the brightly colored brace between the motor and the frame, and the wood brace under the generator.



2. Add oil

The oil fill cap is located on the lower engine block to the right of the recoil start housing. Remove the oil fill cap and fill with 10w30 oil.



3. Add gasoline

The fuel cap is located on top of the fuel tank. Fill the tank with fresh unleaded gasoline 87 octane or higher. The tank is full when you see fuel in the bottom of the fuel filter cup. DO NOT overfill the tank.



4. Turn breaker off

The breaker is located on the right side of the front power panel. Flip the breaker down to prevent accidental load when starting the generator.



5. Turn gas valve on

The gas valve is located above the recoil start on the bottom of the fuel tank. Rotate the valve clockwise to the vertical position to turn on the gas supply.

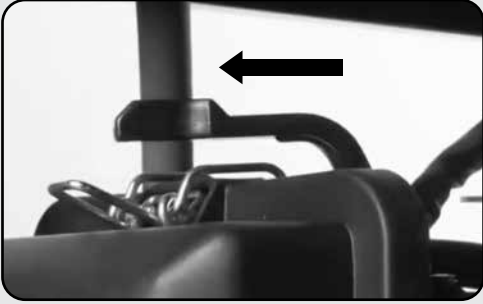

6. Close choke

The choke lever is located above the air cleaner to the right of the recoil start. Slide the lever to the left to cut the air supply and allow more gas into the engine to start.



7. Start generator

The key switch is located on the left side of the front power panel. Insert the key and turn to the start position to start the generator. Allow the key to return to the run position once started.

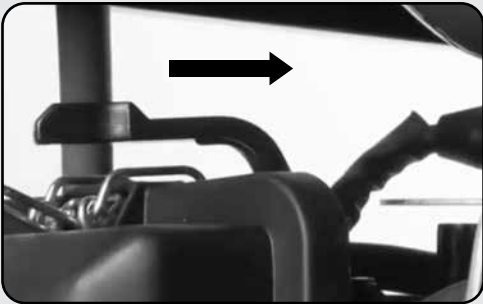

8. Open choke

The choke lever is located above the air cleaner to the right of the recoil start. Slide the lever to the right to open the choke and increase air into the carburetor for normal running.



9. Turn breaker on

The breaker is located on the right side of the front power panel. Flip the breaker up to allow power to flow to the receptacles.



10. Connect devices

Connect your devices to the receptacles on the front panel. Start with the largest loads first.

GENERATOR COMPONENTS

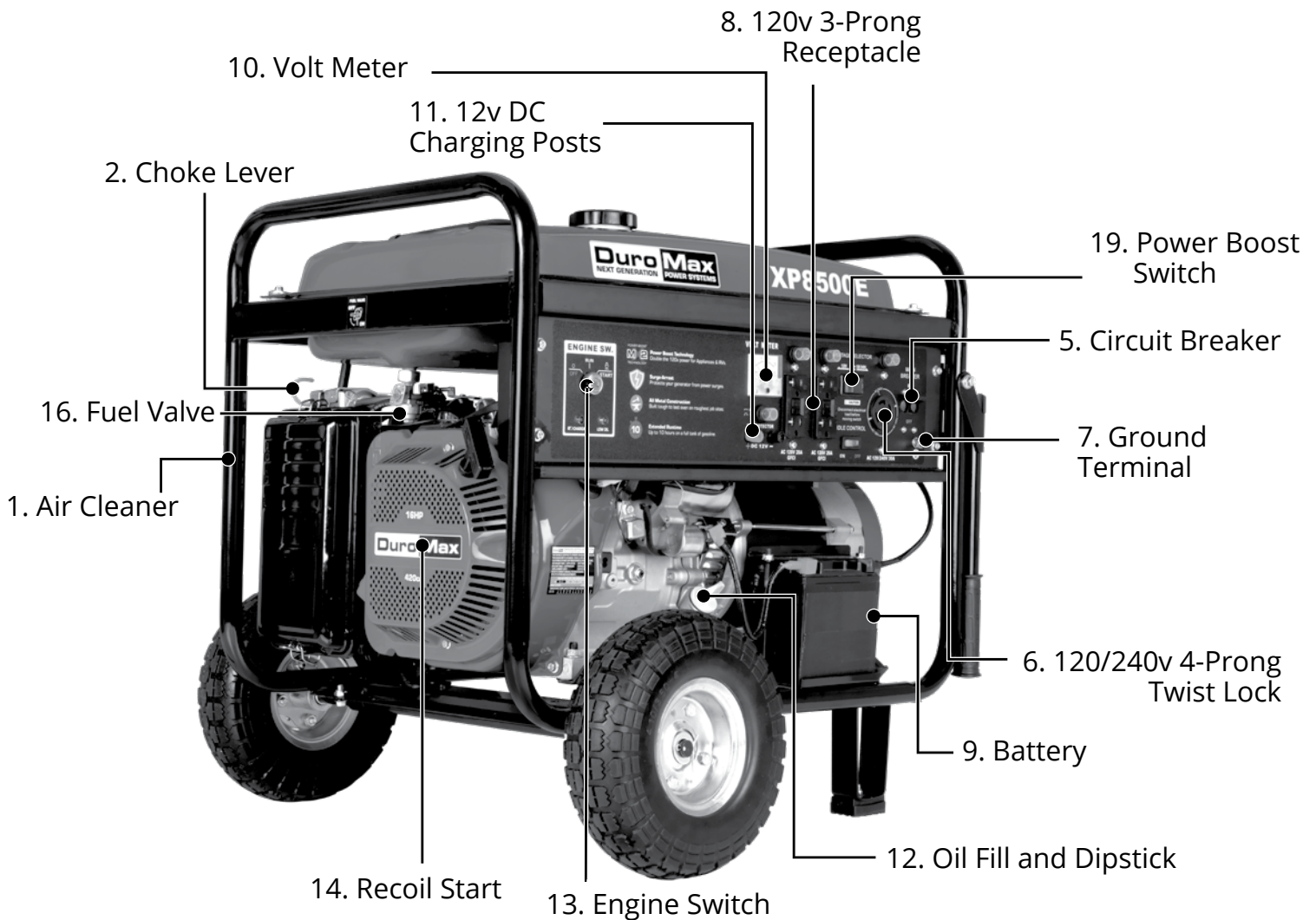

1. **Air Cleaner** - a removable, cleanable, oiled, element that cleans the air going into the engine.
2. **Choke Lever** - Allows the airflow into the carburetor to be restricted to assist in starting the engine.
3. **Fuel Gauge** - Indicates the amount of fuel in the gasoline tank.
4. **Fuel Cap** - Allows access to fill the gasoline tank.
5. **Circuit Breaker** - Resettable switch that protects the generator from electrical overload.
6. **120/240v 4-Prong Twist Lock** - Use to connect electrical devices that run 120 or 240 Volt, 60Hz, single phase, AC current (NEMA L14-30).
7. **Ground Terminal** - Connect a ground wire here to properly ground the generator.
8. **120v 3-Prong Receptacle** - Use to connect electrical devices that run 120 Volt, 60 Hz, single phase, AC current (NEMA 5-20).
9. **Battery** - 12V DC 7ah Battery that powers the Electric Start System.
10. **Volt Meter** - Provides reading of voltage output.
11. **12v DC Charging Posts** - DC Output for charging batteries or running small DC powered items.

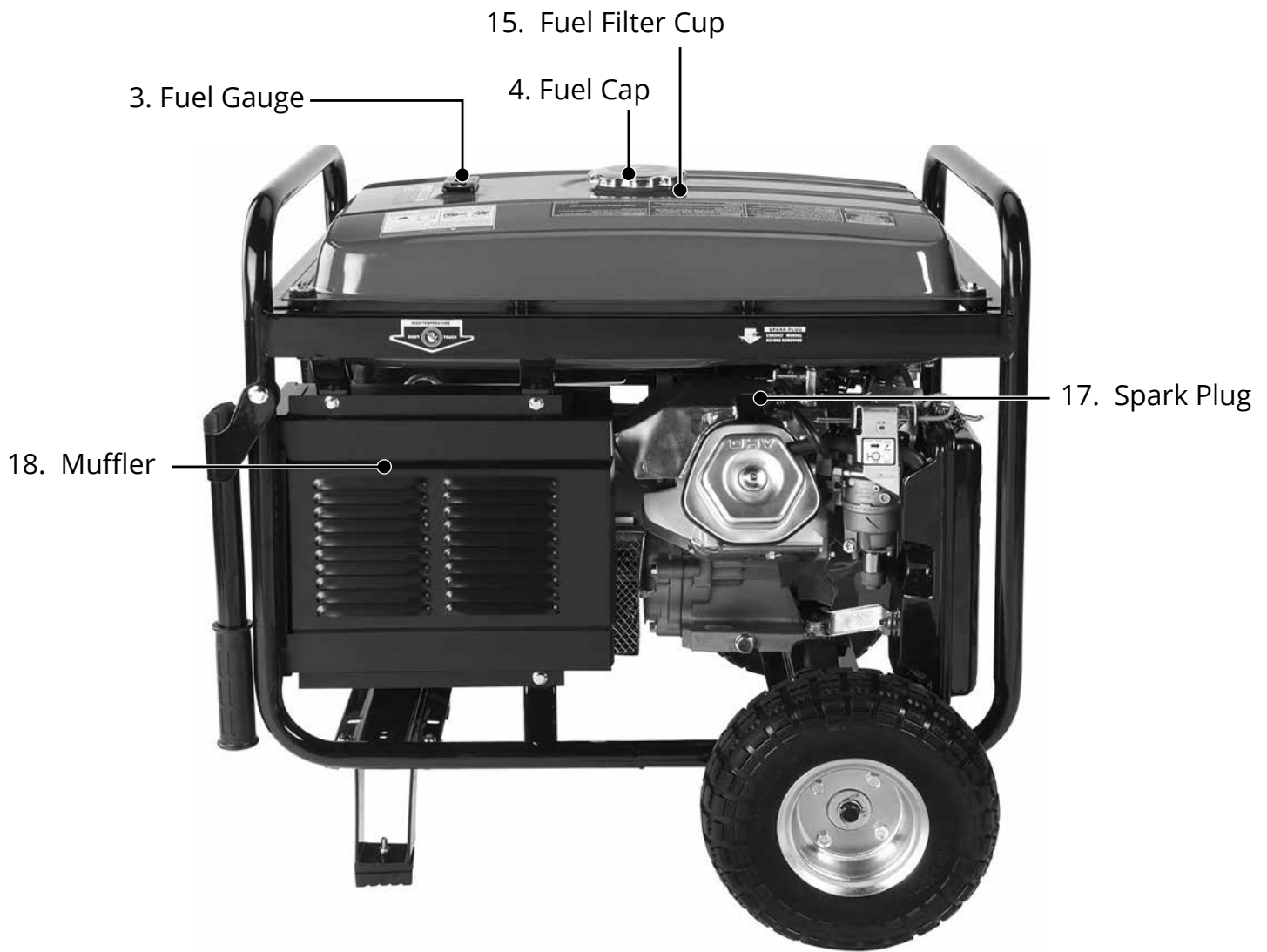

- 12. **Oil Fill and Dipstick** - Use to add or check the oil.
- 13. **Engine Switch** - 3 Position Switch to "Start", "Run", or turn "Off" the generator.
- 14. **Recoil Start** - Easy Pull Recoil Start to start the engine without the electric start.
- 15. **Fuel Filter Cup** - Traps dirt and debris in gasoline before it enters the engine.
- 16. **Fuel Valve** - On/Off Valve that allows fuel into the engine.
- 17. **Spark plug** - Provides ignition to the engine.
- 18. **Muffler** - Reduces engine emissions and reduces noise.
- 19. **Power Boost** - DuroMax exclusive Power Boost doubles the amperage available in "120v Only" for heavy loads like RV air conditioners.

PACKAGE CONTENTS

Your generator comes with the items listed below. Please check to see that all of the following items are included with your generator.



Double Sided Screw Driver

Phillips and slot blade screwdriver used for generator maintenance.

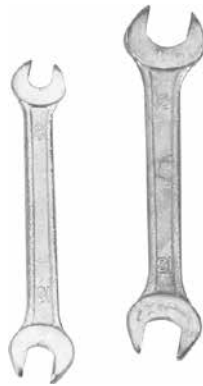

Spanner

Assorted wrenches used in generator maintenance and assembly. Commonly 8mm, 10mm, 13mm, and 15mm.



Spark Plug Wrench

Used in spark plug maintenance, inspection, and installation.



Oil Funnel w/ hose

Used to add oil to the generator without messy spills.



DC Charge Cables

Used in conjunction with the charging posts to charge 12v automotive style batteries or small DC appliances.



Plug Ends

Plug heads for the receptacles found on the generator are included to make or rewire your own cords.

- Note: Actual tools may differ in appearance or design from image shown.



GENERATOR SETUP

Proper setup of your generator will get you going as soon as possible while making sure you and your equipment are safe and cared for.



POWERING EVERYONE...
ANYWHERE!

GENERATOR SETUP

Step 1 - Remove Shipping Braces

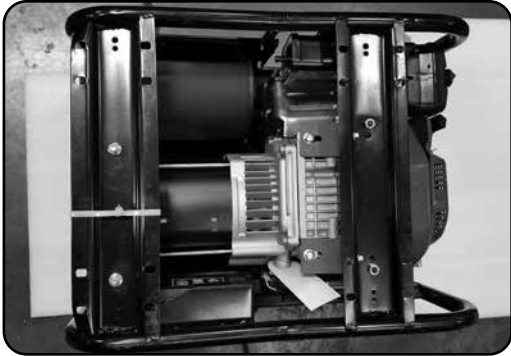

1. Unpack

- a. Remove the generator from the box.
- b. Place the largest piece of packing foam on a flat surface.
- c. Flip the generator upside down on the pad.

CAUTION: NEVER Attempt this if you have put fuel or oil in the generator.



2. Remove braces

The shipping braces prevent engine movement during shipment. Flip the generator over and remove the brightly colored braces between the motor and the frame, and the wood brace under the generator.



Note: Shipping braces can be thrown away. They will not be needed again.

GENERATOR SETUP (CONTINUED)

Step 2 - Wheel Kit Installation (Optional)



1. Install support legs

- a. Secure the support legs to the frame with the provided lock nuts.



2. Install wheel axle

- a. Insert wheel axle bolts through the frame and secure with the provided nut and wrenches.



3. Install wheel axle bracket

- a. Insert wheel axle bracket bolts through the frame and secure with the provided nut and wrenches.

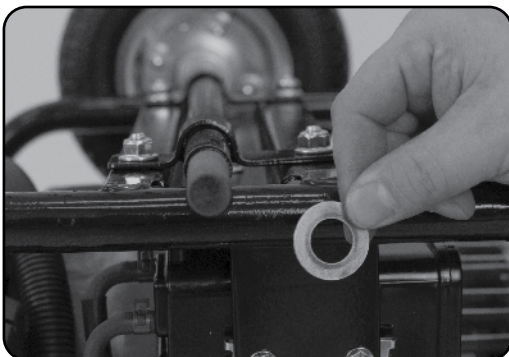

4. Install inside wheel washers

- a. Place one of the large washers onto both sides of the axle behind the wheel.



5. Install wheels

- a. Place the wheels onto either side of the axle.



6. Install outside wheel washers

- a. Place the other large washers onto each side the axle in front of the wheel.

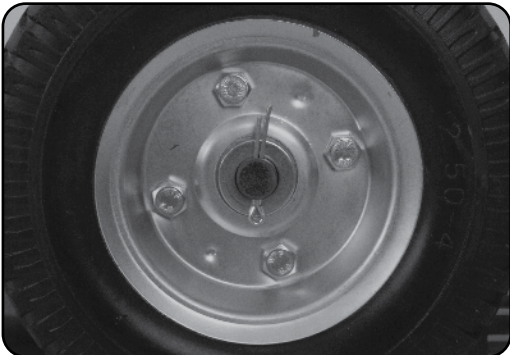

7. Install cotter pins

- a. Place a cotter pin through the hole in each end of the axle and bend it out to secure the wheels.

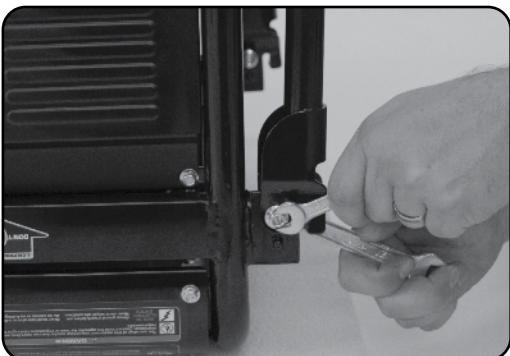

8. Install handles

- a. Attach the handles to the brackets on the frame using the provided bolts and nuts.
- b. Flip the assembled generator over onto its wheels and support brackets.

Do not over tighten the handles, it will prevent free movement.

GENERATOR SETUP (CONTINUED)

Step 3 - Connect the Battery

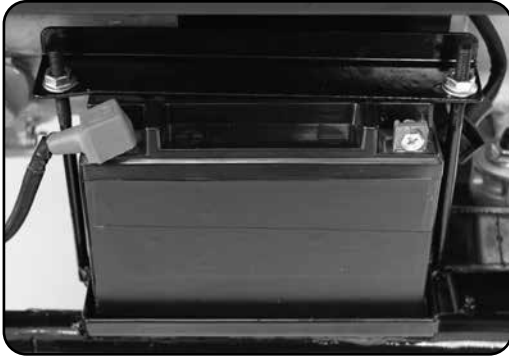

1. Disconnected on arrival

The generator battery is disconnected on arrival to prevent discharge or accidental starting in storage and transportation.

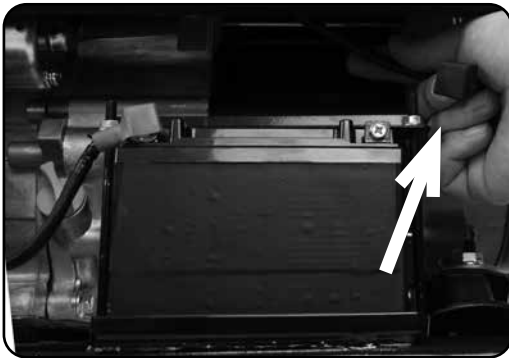

2. Locate the negative cable

- a. Locate the negative battery cable above and behind the battery. One side is connected to ground and the other end needs to be connected to the battery.
- b. Route the free end to the negative battery terminal.



3. Connect the negative cable

- a. Push the black rubber boot up the wire to expose the connector.
- b. Securely connect the free end of the battery cable to the negative battery terminal using the screw and nut from the battery with the screwdriver and wrench from the toolkit.

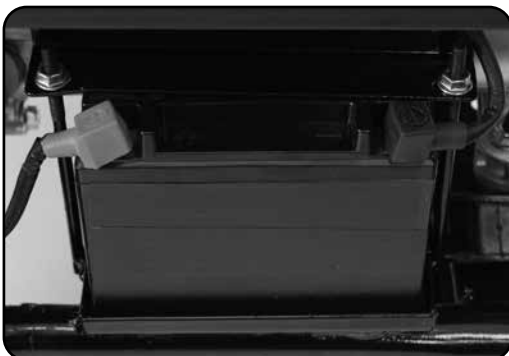

4. Cover the terminal

- a. Cover the connected terminal with the black rubber boot.

Step 4 - Adding Oil

The generator requires engine oil to operate properly. The generator, when new from the package, contains no oil in the crankcase*. You must add the proper amount of oil before operating the generator for the first time. This amount is equal to the oil capacity of the engine crankcase:

Model Number	XP8500E
Engine Oil Capacity	37 fl. oz (1.1L)

WARNING: Do not apply engine oils with additives or 2-stroke gasoline engine oils. They don't have enough lubrication and may shorten the engine's service life.

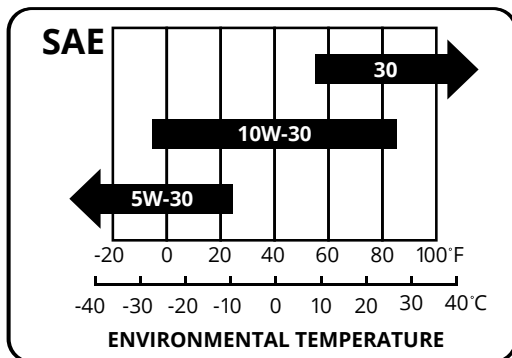

Engine oil recommended: SAE 10W-30. Viscosity varies with regions and temperatures. Choose your oil viscosity using the chart to the left.

* A small amount of oil from factory testing may be present on arrival.



Add oil

- Make sure the generator is on a level surface.
- Unscrew the oil filler/dipstick cap from the engine.
- Using a funnel, add the appropriate amount of oil into the crankcase. You will know the crankcase is full when the oil level has reached the lower lip of the opening you have just poured the oil into.
- Replace the oil filler cap.

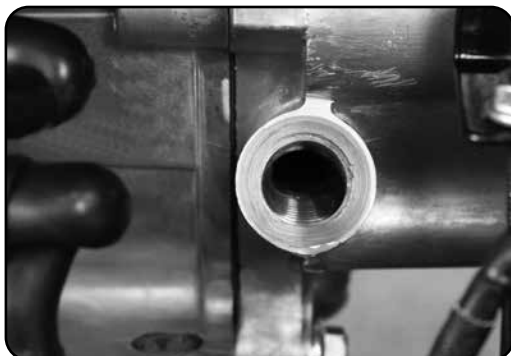

WARNING: DO NOT overfill the crankcase. This may damage the motor and shorten the overall life of your generator.

GENERATOR SETUP (CONTINUED)

Step 5 - Adding Gasoline (Optional)



Add Gasoline

- Make sure the generator is on a level surface.
- Unscrew gas cap and set aside (NOTE: the gas cap may be tight and hard to unscrew).
- Slowly add unleaded gasoline to the fuel tank. Be careful not to overfill. The fuel gauge on the top of the gas tank indicates how much gasoline is in the generator gas tank.
- Replace fuel cap and wipe up any spilled gasoline with a dry cloth.

Model Number	XP8500E
Gas Tank Capacity	7.9 US Gal. (30L)



WARNING: Gas can expand. Do not fill the gas tank to the very top. Leave a minimum of 1.5 in open space.

Gasoline and gas fumes are highly flammable.

Do not fill the tank near an open flame.

Always check for fuel spills.

IMPORTANT:

- To ensure that the generator runs smoothly use only FRESH, UNLEADED GAS WITH AN OCTANE RATING OF 87 OR HIGHER.
- Never use an oil/gasoline mixture. Never use old gas.
- Avoid getting dirt or water in the fuel tank.
- Gas can age in the tank and make it hard to start up the generator in the future.
- Never store generator for extended periods of time with fuel in the tank.

Step 6 - Grounding the Generator



Attach grounding wire

- Ground the generator by tightening the grounding nut against a grounding wire.
- Connect the other end to a copper or brass grounding rod that's driven into the earth.

A generally acceptable grounding wire is a No. 12 AWG (American Wire Gauge) stranded copper wire.



Grounding codes can vary by location. Please contact a local electrician to check the grounding regulations for your area.



WARNING: Failure to properly ground the generator can result in electrocution.

High Altitude Operation

At high altitudes, the standard carburetor air/fuel mixture will be too rich. The performance will decrease, and fuel consumption will increase. A very rich mixture will also foul the spark plug and cause hard starting. Operation at an altitude that differs from that at which this engine was certified, for extended periods of time, may increase emissions. High altitude performance can be improved by specific modifications to the carburetor. If you always operate your generator at altitudes above 3,000 feet (900 meters), have a dealer perform this carburetor modification. This engine, when operated at high altitude with the carburetor modifications for high altitude use, will meet each emission standard throughout its useful life. Even with carburetor modification, engine horsepower will decrease by about 3.5% for each 1,000-foot (300-meter) increase in altitude. The effect of altitude on horsepower will be greater than this if no carburetor modification is made.

When the carburetor has been modified for high altitude operation, the air/fuel mixture will be too lean for low altitude use. Operation at altitudes below 3,000 feet (900 meters) with a modified carburetor may cause the engine to overheat and result in serious engine damage.



POWERING EVERYONE...
ANYWHERE!



STARTING THE GENERATOR

If this is not your first time using the generator there are still steps you should take to prepare it for operation each time you use it.

IMPORTANT: At this point, you should be familiar with the procedures described in the first portion of this section entitled “GENERATOR SETUP” If you have not yet read this section, go back and read it now.

BEFORE YOU START YOUR GENERATOR

Step 1 - Check the oil



Check the oil

The generator is equipped with an automatic shutoff to protect it from damage due to low oil. Nonetheless, you should check the oil level of the engine before each use to ensure that the engine crankcase has a sufficient amount.

To check the oil level:

- a. Make sure the generator is on a level surface.
- b. Unscrew the oil filler/dipstick cap.
- c. With a dry cloth, wipe the oil off of the stick on the inside of the cap.
- d. Insert the dipstick as if you were replacing the cap and then remove it again. There should now be oil on the stick. If there is no oil on the stick, or oil only at the very end of the stick, you should add oil until the engine crankcase is filled (see “Adding Oil” portion of the “Maintenance” section).
- e. Be sure to replace the cap when finished checking oil.



Model Number	XP8500E
Engine Oil Capacity	37 fl. oz (1.1L)

Step 2 - Check the gas level (Optional)

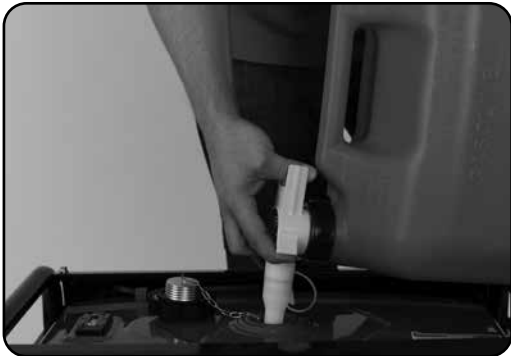

Check fuel level

If running the engine on gasoline check to see that there is sufficient gasoline in the fuel tank. The fuel gauge on top of the tank will give a rough estimate of the gasoline level. The gauge will appear white then fill red as the tank is filled.

Note: Fuel gauge may not register with less than 1/3 fuel tank full.



WARNING: Gasoline and gasoline fumes are highly flammable.

- Do not fill the tank near an open flame.
- Always allow the engine to cool for several minutes before refueling.
- DO NOT overfill the fuel tank. Fuel expands when shaken or heated. ALWAYS leave 1 1/2" space or more at the top of the tank.
- ALWAYS use fresh fuel or stabilized fuel. Old gasoline (older than 30 days) can cause permanent damage to the fuel system.
- Always check for fuel spills.

STARTING THE GENERATOR

Starting the Generator

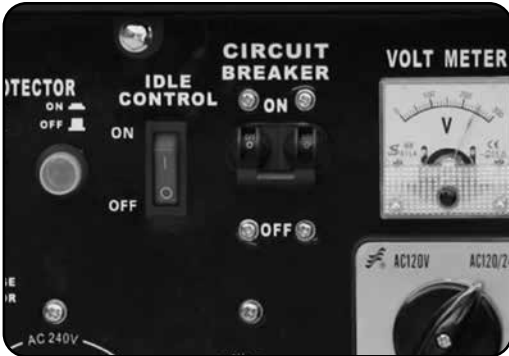

1. Shut breaker off

The breaker is located on the right side of the front power panel. Flip the breaker down to prevent accidental load when starting the generator.

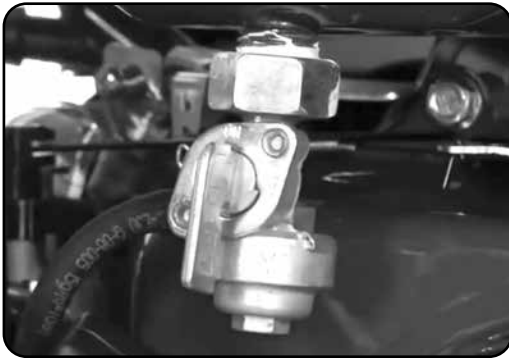

2. Turn gas valve on

The gas valve is located above the recoil start on the bottom of the fuel tank. Rotate the valve clockwise to the vertical position to turn on the gas supply.

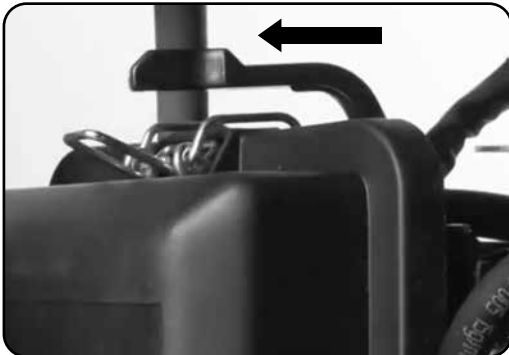

3. Close choke

The choke lever is located above the air cleaner to the right of the recoil start. Slide the lever to the left to cut the air supply and allow more gas into the engine to start.



4. Turn engine switch to START

The key switch is located on the left side of the front power panel. Insert the key and turn to the start position to start the generator. Allow the key to return to the run position once started.



5. Turn engine switch to ON

When the engine starts, allow the engine switch to return to the ON position.

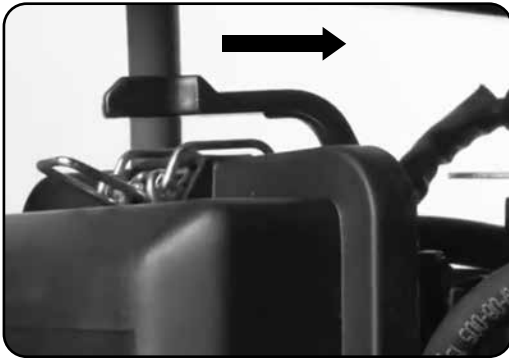

6. Open choke

Push the choke to the OPEN position as the engine warms up.



CAUTION: Disconnect all electrical loads from the generator before attempting to start!



WARNING: Operating the starter motor for more than 5 seconds can damage the motor. If the engine fails to start, release the switch and wait 10 seconds before operating the starter again.

STARTING THE GENERATOR (CONTINUED)

Starting the Generator Using Recoil Start



1. Shut breaker off

The breaker is located on the right side of the front power panel. Flip the breaker down to prevent accidental load when starting the generator.

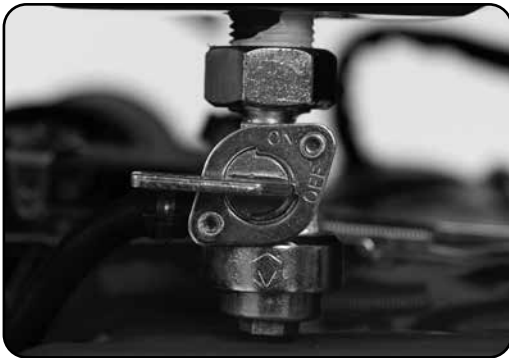

2. Select your fuel.

If using gasoline, see step 2 on pg. 36. If using propane see steps 2 - 4 on pg. 38.

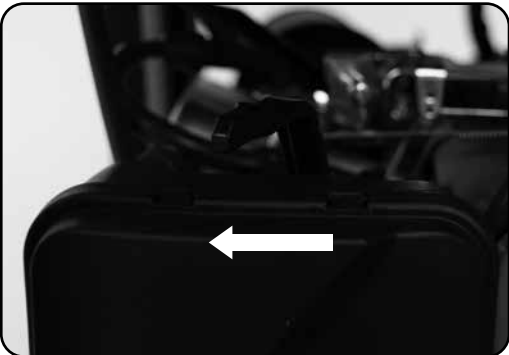

3. Close choke

The choke lever is located above the air filter to the left of the recoil start. Slide the lever to the left to cut the air supply and allow more gas into the engine to start.



4. Turn engine switch to Run

The key switch is located on the left side of the front power panel. Insert the key and turn to the run position to start the generator. Allow the key to return to the run position once started.



5. Pull the recoil start

The recoil start is located on the left side panel next to the air filter. Pull the recoil handle slowly until resistance is felt, then quickly pull the recoil handle until fully extended.

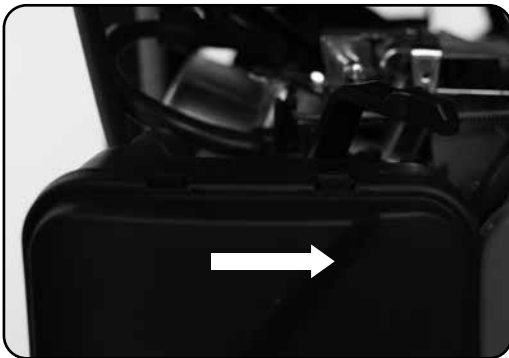

6. Open choke

After the engine has started. Push the choke to the OPEN position as the engine warms up.



7. Turn breaker on / connect

The breaker is located on the right side of the front power panel. Flip the breaker up to allow the power to flow to the receptacles. Connect your devices to the receptacles on the front panel. Start with the largest loads first.



CAUTION: Disconnect all electrical loads from the generator before attempting to start!



CAUTION: Release the recoil handle only after the cord has retracted. Releasing the recoil handle while extended may cause harm to yourself or your equipment.



POWERING EVERYONE...
ANYWHERE!



USING THE GENERATOR

If this is not your first time using the generator, there are still steps you should take to prepare it for operation each time you use it.

IMPORTANT: At this point, you should be familiar with the procedures described in the first portion of this section entitled “GENERATOR SETUP”; if you have not yet read this section, go back and read it now.

USING THE GENERATOR

AC Usage

- You may connect electrical devices running on AC current according to their wattage requirements.
- The chart below shows the rated and surge wattage of your generator according to its model number.
- The rated wattage corresponds to the maximum wattage the generator can output on a continuous basis.
- The surge wattage corresponds to the maximum amount of power the generator can output for a short period of time. Many electrical devices such as refrigerators require short bursts of extra power, in addition the rated wattage listed by the device, to stop and start their motors. The surge wattage ability of the generator covers this extra power requirement.

Fuel Source	Rated (Running Wattage)	Surge (Peak) Wattage
Gasoline	7000	8500

The total running wattage requirement of the electrical devices connected to the generator should not exceed the rated wattage of the generator itself. To calculate the total wattage requirement of the electrical devices you wish to connect, find the rated (or running) wattage of each device. This number should be listed somewhere on the device or in its instruction manual.

If you cannot find this wattage, you may calculate it by multiplying the Voltage requirement by the Amperage drawn: $\text{Watts} = \text{Volts} \times \text{Amps}$. If these specifications are not available you may estimate the Watts required by your device by using the chart on the next page.

Once you have found the rated wattage requirement of each electrical device, add these numbers to find the total rated wattage you wish to draw from the generator. If this number exceeds the rated wattage of the generator, DO NOT connect all these devices. Select a combination of electrical devices, which has a total rated wattage lower than or equal to the rated wattage of the generator.

Tool or Appliance	Rated (Running) Watts	Additional Surge Watts
Electric water heater (40 gal)	4000	0
Hot plate	2500	0
Radial arm saw	2000	2000
Electric Stove	1500	0
Circular Saw	1500	1500
Air compressor (1 HP)	1500	3000
Window air conditioner	1200	1800
Miter saw	1200	1800
Microwave	1000	2000
Well water pump	1000	1500
Reciprocating saw	960	1040
Sump pump	800	1200
Refrigerator freezer	800	1200
Furnace blower	800	1300
Computer	800	0
Electric drill	600	900
Television	500	0
Deep freezer	500	800
Garage door opener	480	600
Stereo	400	0
Box fan	300	600
Clock radio	300	0
Security system	180	0
DVD Player	100	0
Common light bulb	75	0



CAUTION - The generator can only run at its surge wattage capacity for a very short time. Connect only electrical devices requiring a rated (running) wattage equal to or less than the rated wattage of the generator. Never connect devices requiring a rated wattage equal to the surge wattage of the generator.

*NOTE: The above wattage figures are estimates only.
Try to check the wattage listed on your electrical devices before consulting this chart.*

USING THE GENERATOR (CONTINUED)

Connecting a load to the generator

NOTE: Be sure to attach devices to the correct receptacle (outlet).

- 120v devices can be directly connected to the 120v ONLY receptacles.
- 120v devices can be connected to the 120/240v receptacle using an appropriate adapter.
- 240v devices can ONLY be connected the 240v receptacle.



CAUTION: Do not connect 50Hz or 3-phase loads to the generator.

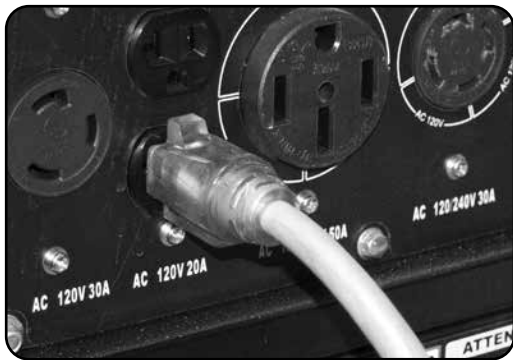

1. Plug in devices

Plug in devices to the appropriate receptacle. When using the generator in 120/240v mode, balance the load as closely as possible. Placing more load on one side of the circuit will reduce the breaker trip period.



2. Turn breaker on

Flip the circuit breaker up to the on position to allow power to the receptacles.



3. Turn on connected devices

Start or turn on appliances starting with the biggest loads first.

Voltage Selector Switch

This generator features Power Boost Technology, which gives the user the ability to double the power in the generator for more heavy duty applications.

The voltage selector switches the dual 120v AC windings of the generator to produce "120V ONLY" or "120/240V". If a 240V appliance is connected to the 4-prong receptacle, the switch must be in the "120/240V" position. If only 120V appliances are being connected to the generator select the "120V ONLY" position to double the 120v amperage and automatically balance the load.



WARNING - Only change the Voltage Selector Switch with the main AC Circuit Breaker OFF. The generator can be seriously damaged if the Voltage Selector Switch is changed with the breaker ON.

Choosing the right power cord

Long or thin cords can drain the power provided to an electrical device by the generator. When using such cords, allow for a slightly higher rated wattage requirement for the electrical device. See table below for recommended cords based on the power requirement of the electrical device.

DEVICE REQUIREMENTS		WIRE GAUGE BY LENGTH (ft.)				
AMPS	WATTS (120/240V)	10	25	50	100	150
5	600/1200	18	16	14	12	10
10	1200/2400	16	14	12	10	8
15	1800/3600	14	12	10	8	6
20	2400/4800	12	10	8	6	4
25	3000/6000	10	8	6	4	4
30	3600/7200	8	6	4	4	NR
40	4800/9600	6	4	4	NR	NR
50	6000/1200	4	4	2	NR	NR

***NR = NOT RECOMMENDED**

USING THE GENERATOR (CONTINUED)

DC Usage



CAUTION: The DC receptacle is for recharging 12 Volt automotive-type batteries only. Do not connect any other device to this receptacle.



CAUTION: Never try to jump start a car with your generator.



1. Connect the battery

Connect one charging wire to the positive terminal on the battery and the other charging wire to the negative terminal on the battery.



2. Connect positive receptacle

Connect the free end of the positive wire to the positive receptacle (outlet) on the generator.



3. Start Generator

The key switch is located on the left side of the front power panel. Insert the key and turn to the start position to start the generator. Allow the key to return to the run position once started.

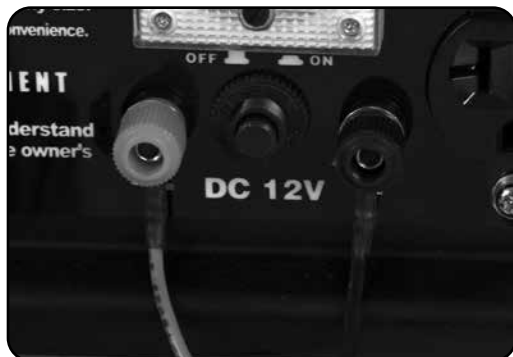

4. Connect negative receptacle

Carefully connect the free end of the negative wire to the negative receptacle on the generator.



5. Disconnecting

When disconnecting, always disconnect the wires from the generator first to avoid a spark.



DANGER - Stored batteries emit highly explosive hydrogen gas when charged. Batteries also contain acid, which can cause severe chemical burns.



DANGER - Do not allow open flames or cigarettes nearby for several minutes after charging a battery.



DANGER - Always wear protective goggles and rubber gloves when charging a battery.



DANGER - If battery acid gets on your skin, flush with water. If battery acid gets in your eyes, flush with water and call a physician immediately.



DANGER - If battery acid is swallowed, drink large quantities of milk and call a Physician immediately.





MAINTENANCE AND CARE

Proper maintenance and storage of your generator is essential to ensure trouble free use of your generator when you need it.

By following the maintenance and care requirements, you can keep your generator running smooth and efficient for years to come.

MAINTENANCE AND CARE

Proper routine maintenance of your generator is essential for safe, economical, and trouble-free operation. It will also help reduce air pollution.



WARNING: Improper maintenance, or failure to correct a problem before operation, can cause a malfunction in which you can be seriously injured or killed. Always follow the inspection, maintenance recommendations, and schedules in this instruction manual.

- Make sure the engine is off before you begin any maintenance or repairs.
- Let the engine and exhaust system cool before touching.
- To reduce the possibility of fire or explosion, be careful when working around gasoline. Use only a nonflammable solvent, not gasoline, to clean parts. Keep cigarettes, sparks, and flames away from all fuel-related parts.

Maintenance Schedule

Remember that this schedule is based on the assumption that your machine will be used for its designed purpose. Sustained high-load, high-temperature operation, or use in unusually wet or dusty conditions, will require more frequent service.

SERVICE		REGULAR SERVICE PERIOD				
		BEFORE EACH USE	EVERY MO. OR 20 HRS	EVERY 3 MO. OR 50 HRS	EVERY 6 MO. OR 100 HRS	EVERY 12 MO. OR 300 HRS
ENGINE OIL	CHECK					
	CHANGE					
AIR CLEANER	CHECK					
	CHANGE					
SEDIMENT CUP	CLEAN					
SPARK PLUG	CLEAN-ADJUST					
	REPLACE					
SPARK ARRESTOR	CLEAN					
IDLE SPEED	CHECK / ADJUST					
VALVE CLEARANCE	CHECK-ADJUST					
COMBUSTION CHAMBER	CLEAN	500 HOURS				
FUEL TANK / FILTER	CLEAN					
FUEL TUBE	CHECK	EVERY 24 MO. (REPLACE IF NECESSARY)				
TO BE PERFORMED AT MONTHS INDICATED OR HOUR INTERVAL WHICHEVER COMES FIRST						

MAINTENANCE AND CARE (CONTINUED)

Checking the oil



Check the oil

The generator is equipped with an automatic shutoff to protect it from damage due to low oil. Nonetheless, you should check the oil level of the engine before each use to ensure that the engine crankcase has a sufficient amount.

To check the oil level:

- a. Make sure the generator is on a level surface.
- b. Unscrew the oil filler/dipstick cap.
- c. With a dry cloth, wipe the oil off of the stick on the inside of the cap.
- d. Insert the dipstick as if you were replacing the cap and then remove it again. There should now be oil on the stick. If there is no oil on the stick, or oil only at the very end of the stick, you should add oil until the engine crankcase is filled (see “Adding Oil” portion of the “Maintenance” section).
- e. The oil will be visible in the oil fill spout when full.
- f. Be sure to replace the cap when finished checking oil.



Model Number	XP8500E
Engine Oil Capacity	37 fl. oz (1.1L)

Changing the oil



Worn out or dirty oil does not cool the generator properly and can lead to catastrophic engine damage.

In addition to regular oil changes, it is necessary to drain the oil from the crankcase if it has become contaminated with water or dirt.



1. Remove drain plug

Using a 12 mm hex wrench, unscrew the oil drain plug, which is located on the crankcase underneath the oil filler/dipstick cap.

Allow all the oil to drain from the generator.



2. Drain oil

Drain oil into an approved oil disposal container. Contact your local auto parts store for information on oil disposal.



3. Replace drain plug

Replace the oil drain plug and tighten with a 12 mm hex wrench.

MAINTENANCE AND CARE (CONTINUED)

Cleaning the air filter

MAINTAIN AIR FILTER

Clean air filter after every 50 hours of use
(every 10 hours in unusually dusty conditions)

Wash filter element with household detergents.
Wipe out dust from air filter housing before
replacing filter element.

Never clean with a brush

Routine maintenance of the air cleaner helps maintain proper airflow to the carburetor. Check that the air cleaner is free of excessive dirt after every use.

Note: Improper maintenance may cause less air to enter the engine or dirty air to enter the engine causing overheating and engine wear.



1. Remove the filter cover

Release the clips on the top and bottom of the cover and remove the filter cover.



2. Remove filter

Remove the sponge-like elements from the casing.



3. Clean out filter casing

Wipe the dirt from inside the empty air cleaner casing.



4. Wash cleaner element

Wash the sponge-like elements in household dish detergent and warm water.



5. Dry cleaner element

Pat dry on a dry cloth and allow the elements to dry completely.



6. Add engine oil to elements

Soak the dry elements in a small amount of engine oil. Ring out any excess oil.



7. Replace elements in casing

Replace the sponge-like elements in the air cleaner casing and replace the cover.

MAINTENANCE AND CARE (CONTINUED)

Spark Plug Maintenance



The spark plug is important for proper engine operation. A good spark plug should be intact, free of deposits, and properly gapped.

Improper maintenance may cause reduced fuel economy, misfires, trouble starting, or damage to the spark plug threads.



1. Remove spark plug cap

Pull on the spark plug cap to remove it.



2. Remove spark plug

Unscrew the spark plug from the generator using the spark plug wrench included with this product.



3. Inspect spark plug

Visually inspect the spark plug. If it is cracked or chipped, discard and replace it with a new spark plug. We recommend using an F6RTC spark plug such as NGK BPR6ES.



4. Measure plug gap

Measure the plug gap with a gauge. The gap should be 0.7-0.8 mm (0.028-0.031 in).



5. Clean and re-gap

If you are re-using the spark plug, use a wire brush to clean any dirt from around the spark plug base and then re-gap the spark plug.



6. Install spark plug

Screw the spark plug back into its place on the generator using the spark plug wrench.



7. Replace spark plug cap

Replace the spark plug cap.

MAINTENANCE AND CARE (CONTINUED)

Emptying the Gas Tank



If you have been using gasoline in your generator; before storing your generator for extended periods of time you should drain your generator fuel tank of gasoline.



CAUTION: Do not store fuel from one season to another. Gasoline sold at the pump today contains additives such as ethanol that even when stored properly may damage the fuel system components.



1. Shut fuel valve off

Turn the fuel valve to the "OFF" position.



2. Remove fuel filter cup

Remove the fuel filter cup (see "Removing the Fuel Filter Cup" earlier in this section).



3. Empty fuel filter cup

Empty the fuel filter cup of any fuel.



4. Drain gas from the generator

With a funnel underneath the fuel valve to catch the gas, turn the fuel valve to the "ON" position. Drain all the gas from the generator.



5. Shut fuel valve off

Turn the fuel valve to the "OFF" position.



6. Replace fuel filter cup

Reinstall the fuel filter cup.



7. Store emptied gas

Store the emptied gasoline in a suitable place and add fuel stabilizer to keep fuel fresh and usable.

MAINTENANCE AND CARE (CONTINUED)

Cleaning the fuel filter cup



1. Shut fuel valve off

Turn the fuel valve to the "OFF" position.



2. Remove fuel filter cup

Unscrew the fuel filter cup from the fuel valve using a wrench.



3. Clean filter cup

Clean the cup of all sediment using a rag or brush.



4. Replace fuel filter cup

Reinstall the fuel filter cup.

Storage and Transportation



CAUTION: Never place any type of storage cover on the generator while it is still hot.

When transporting your generator:

- Empty the gas tank (see “Emptying the Gas Tank” in the “Maintenance” section).
- Disconnect the spark plug.
- Do not obstruct any ventilation openings & keep the generator in a cool dry area.

Storage Period	Storage Preparation
If you plan on starting the same day.	<ol style="list-style-type: none"> 1. Turn off the main breaker. 2. Allow the unit to run 3 - 5 minutes. 3. Turn off the key. 4. Store.
If you plan on starting the unit again within 30 days.	<ol style="list-style-type: none"> 1. Turn off the main breaker. 2. Allow the unit to run 3 - 5 minutes. 3. Turn off the fuel valve. 4. Allow the unit to stall out. 5. Turn off the key. 6. Add fuel stabilizer to the gas remaining in the tank. 7. Store.
If you do not plan to start the unit for longer than 30 days.	<ol style="list-style-type: none"> 1. Turn off the main breaker. 2. Allow the unit to run 3 - 5 minutes. 3. Turn off the fuel valve. 4. Allow the unit to stall out. 5. Turn off the key. 6. Drain the fuel tank (See “Emptying the Gas Tank” in the “Maintenance” section) 7. Drain the carburetor <ol style="list-style-type: none"> a. Remove the drain bolt from the carburetor. b. Drain the small amount of remaining fuel from the carburetor bowl. 8. Oil the cylinder <ol style="list-style-type: none"> a. Remove the spark plug. b. Put 2 tbsp. of 10w30 motor oil directly into the spark plug hole c. Pull the recoil start one time. d. Replace the plug. 9. Remove the battery and place on tender indoors.

SPECIFICATIONS

AC Rated Wattage	7000W	
AC Surge Wattage	8500W	
AC Rated Voltage	120/240V	
AC Rated Frequency	60 Hz	
AC Phase	Single	
DC Voltage	12V	
DC Amperage	8.3A	
Dimensions	LENGTH	28in.
	WIDTH	22in.
	HEIGHT	23in.
Engine Type	4-Stroke OHV Forced-Air	
Ignition System	Non-Contact Transistor	
Displacement	420cc	
Starting Type	Electric	
Fuel Tank Capacity	7.9 US Gal. (30L)	
Oil Capacity	37 fl. oz. (1.1L)	
Run Time @ 50%	10 hr.	
Noise Level	<74db	



TROUBLESHOOTING

This section of the manual is to help you troubleshoot problems with your generator.

TROUBLESHOOTING

Mode	Description	
Engine will not start	Engine Switch is "Off"	Set engine switch to "run"
	Fuel Valve is "Closed"	Turn fuel valve to "open"
	Choke is open	Close the choke
	Engine is out of fuel	Add fuel
	Fuel is old or contaminated	Change fuel
	Spark Plug is dirty	Clean spark plug
	Spark Plug is broken	Replace spark plug
	Generator is not level	Move generator to a level surface
	Oil is low.	Add / change oil
Engine runs, but there is no electrical output	Circuit breaker is "Off"	Turn "on" circuit breaker
	Wiring connection is bad	Replace extension cord(s)
	Device connected to generator is malfunctioning	Disconnect malfunctioning device
Generator runs, but does not support all electrical devices connected	Generator is overloaded	Disconnect 1 or more items to reduce the load
	Device connected to generator is bad	Disconnect malfunctioning device
	Air Cleaner is dirty.	Clean / replace the air filter

Changing / Inspecting the Carbon Brushes

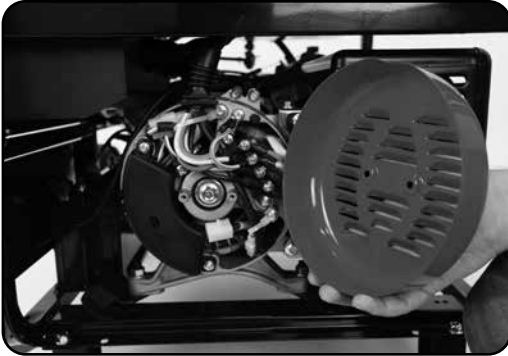

The carbon brushes in conjunction with the AVR regulates power from the generator. The carbon brushes are wearable parts and should be inspected every 250 running hours.

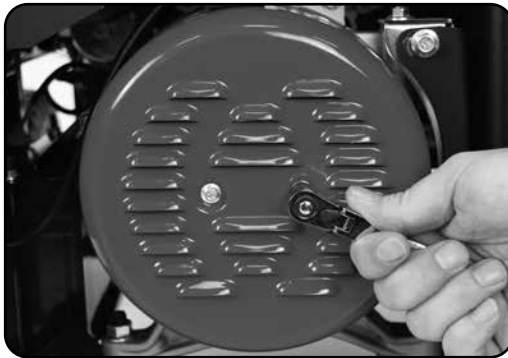

1. Remove generator cover

Remove the 2 bolts of the generator cover then pull the cover off the generator.



2. Remove bolt from brush

Remove the bolt holding the carbon brush.



3. Disconnect AVR wires

Remove the two wires from the AVR on the carbon brush

TROUBLESHOOTING (CONTINUED)

Changing / Inspecting the Carbon Brushes (Cont.)

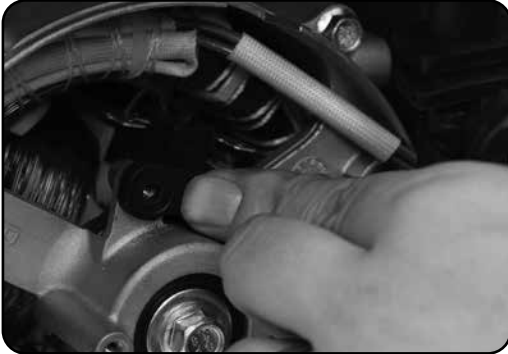

4. Install new brush

Install new carbon brush with bolt.



5. Connect AVR wires

Insert and connect the 2 wires from the AVR, be sure to connect + and - correctly.

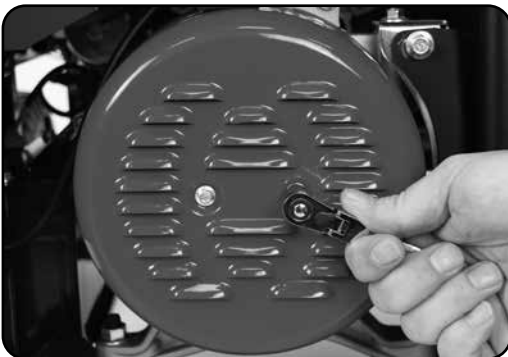

6. Replace generator cover

Replace the back cover of the generator and secure it with the 2 bolts.

Changing / Inspecting the AVR

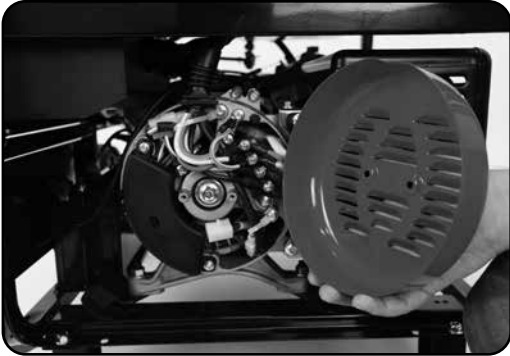

The carbon brushes in conjunction with the AVR regulates power from the generator. If the generator is overheated or overloaded, the AVR may be damaged and require replacement.



1. Remove generator cover

Remove the 2 bolts of the generator cover then pull the cover off the generator.



2. Remove AVR bolts

Remove the 2 bolts holding the AVR.



3. Disconnect AVR wire clip

Disconnect the wire clip.

TROUBLESHOOTING (CONTINUED)

Changing / Inspecting the AVR (Continued)



4. Disconnect wires from brush

Remove the 2 wires from the AVR on the carbon brush.



5. Install new AVR

Install the new AVR with the 2 bolts.



6. Reconnect wires to brush

Insert and connect the 2 wires from the AVR, be sure to connect + and - correctly.



7. Reconnect the AVR wire clip

Reconnect the wire clip.

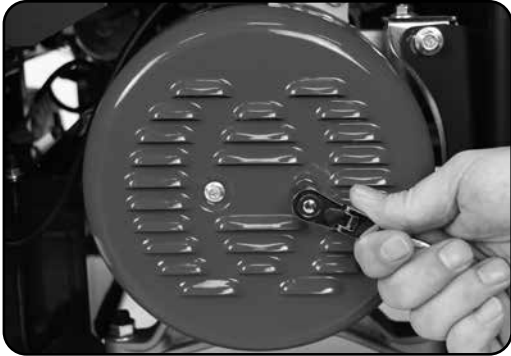

8. Replace generator cover

Replace the back cover of the generator and secure it with the 2 bolts.

WIRING DIAGRAM

Bl	Black	Br	Brown	Y/G	Yellow/Green
O	Orange	Br/R	Brown/Red	B/W	Black/White
Bu	Blue	LB	Light Blue	G	Green
Gr	Grey	Bl	Black		
R	Red	W	White		

	IG	E	BAT	ST	FS	G
OFF						
ON						
Start						

Engine Switch Connecting

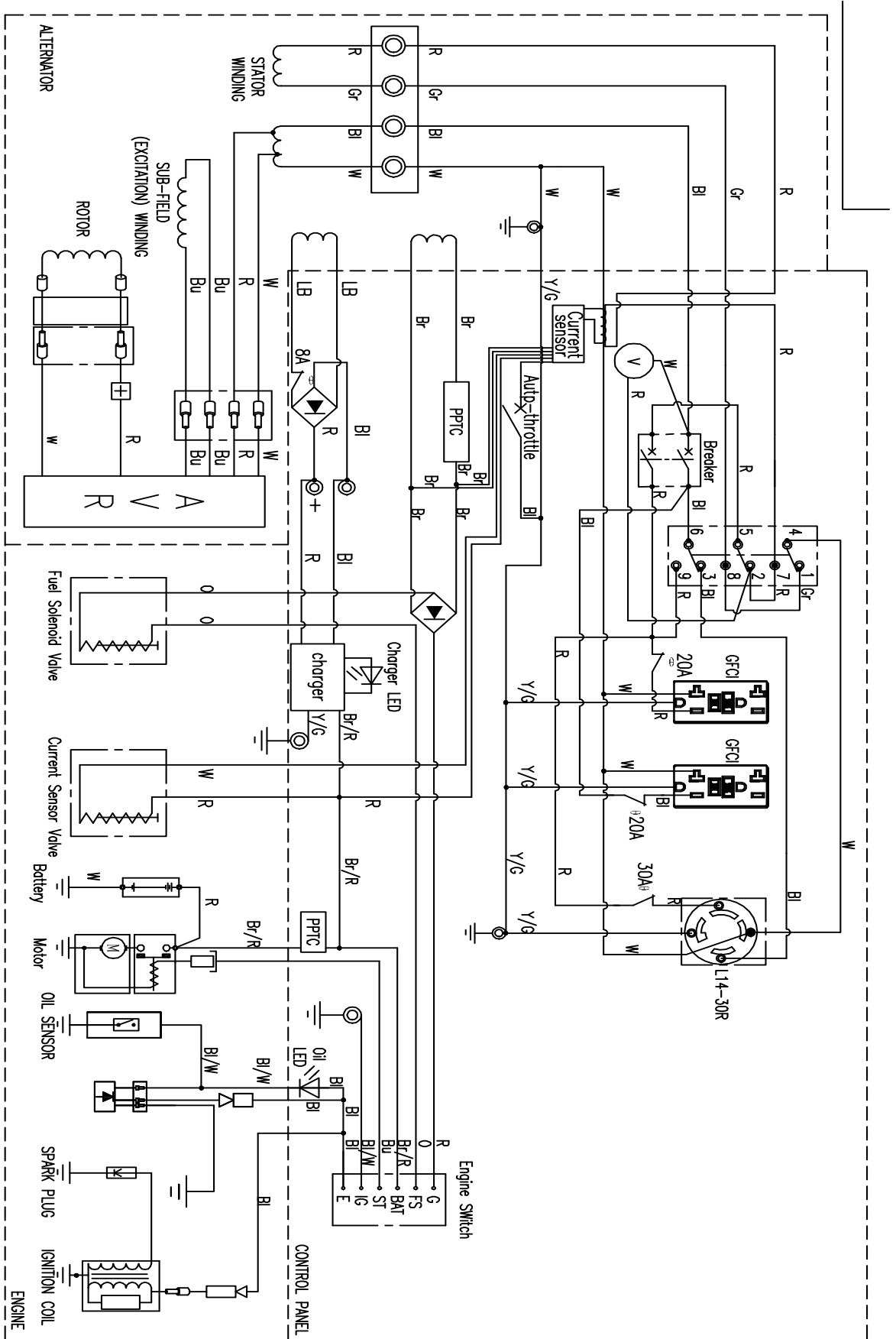



POWERING EVERYONE...
ANYWHERE!

WARRANTY

3-year Warranty

All DuroMax Power Equipment warrant the original purchasers to a 3-year Parts Warranty (Residential Use ONLY: Unusually heavy or commercial use is covered for a period of 1-year) in the event of failure due to defects in electrical or mechanical components. Freight on any items submitted for replacement or repair under the Warranty is the responsibility of the equipment owner. This warranty is non-transferable and only valid to the original purchaser.

Warranty Exclusions

The DuroMax Power Equipment warranty does not cover repairs or returns when the fault is: Normal Wear and Tear, Installation Use or Maintenance Services, Cosmetic defects, Accessories, Failures due to acts of God or Natural Disasters, or problems related to/from aftermarket or non-OEM parts.

Warranty Limitations

DuroMax Power Equipment does not claim or hold any obligation to loss of time, freight charges, use of the product, or any incidental damages from the use of this product. THIS WARRANTY IS IN LIEU OF ALL OTHER WARRANTIES, EXPRESSED OR IMPLIED.

U.S EPA AND CALIFORNIA EMISSION CONTROL WARRANTY STATEMENT YOUR WARRANTY RIGHTS AND OBLIGATIONS

The California Air Resources Board, The United States Environmental Protection Agency (US EPA) and DuroMax Power Equipment, are pleased to explain the emission control system warranty on your 2020-2021 year small off-road engine. In the United States and California, new small off-road engines must be designed built and equipped to meet the State's stringent anti-smog standards. DuroMax Power Equipment must warrant the emission control system on your small off-road engine for the periods of time listed below provided there has been no abuse neglect or improper maintenance of your small off-road engine.

Your emission control system may include parts such as the carburetor or fuel injection system, the ignition system, and a catalytic converter. Also included may be hoses, belts, connectors, and other emission-related assemblies.

Where a warrantable condition exists, DuroMax Power Equipment will repair your small off-road engine at no cost to you including diagnosis, parts, and labor.

MANUFACTURER'S WARRANTY COVERAGE:

As the small off-road engine owner, you are responsible for the performance of the required

maintenance listed in your owner's manual. DuroMax Power Equipment recommends that you retain all receipts covering maintenance on your small off-road engine, but DuroMax Power Equipment cannot deny warranty solely for the lack of receipts or for your failure to ensure the performance of all scheduled maintenance.

As the small off-road engine owner, you should, however, be aware that DuroMax Power Equipment may deny you warranty coverage if your small off-road engine or a part has failed due to abuse, neglect, improper maintenance or unapproved modifications.

You are responsible for presenting your small off-road engine to a DuroMax Power Equipment distribution center as soon as a problem exists. The warranty repairs should be completed in a reasonable amount of time, not to exceed 30 days.

If you have any questions regarding your warranty rights and responsibilities, contact DuroMax Power Equipment authorized warranty service facility:

TEL: 1-844-387-6629

WEBSITE: www.duromaxpower.com

ADDRESS: 5800 Ontario Mills Pkwy, Ontario CA 91764

This telephone number is only for the engines which the company name "DuroMax Power Equipment" on the emission label.

DEFECTS WARRANTY REQUIREMENTS:

(a) The warranty period begins on the date the engine or equipment is delivered to an ultimate purchaser.

(b) General Emissions Warranty Coverage. DuroMax Power Equipment warrants to the ultimate purchaser and each subsequent owner that the engine or equipment is:

- (1) Designed, built, and equipped so as to conform with all applicable regulations adopted by US EPA & Air Resources Board; and
- (2) Free from defects in materials and workmanship that causes the failure of a warranted part for a period of two years.

(c) The warranty on emissions-related parts will be interpreted as below:

- (1) Any warranted part that is not scheduled for replacement as required maintenance in the written instructions required by subsection (d) must be warranted for the warranty period defined in Subsection(b)(2). If any such part fails during the period of warranty coverage, it must be repaired or replaced by DuroMax Power Equipment according to

WARRANTY (CONTINUED)

Subsection (4) below. Any such part repaired or replaced under the warranty must be warranted for the remaining warranty period.

- (2) Any warranted part that is scheduled only for regular inspection in the written instructions required by subsection(d) must be warranted for the warranty period defined in Subsection(b) (2). A statement in such written instructions to the effect of "repair or replace as necessary" will not reduce the period of warranty coverage. Any such part repaired or replaced under warranty must be warranted for the remaining warranty period.
- (3) Any warranted part that is scheduled for replacement as required maintenance in the written instructions required by subsection (d) must be warranted for the period of time prior to the first scheduled replacement point for that part. If the part fails prior to the first scheduled replacement, the part must be repaired or replaced by DuroMax Power Equipment according to Subsection (4) below. Any such part repaired or replaced under warranty must be warranted for the remainder of the period prior to the first scheduled replacement point for the part.
- (4) Repair or replacement of any warranted part under the warranty must be performed at no charge to the owner at a warranty station. (5) Notwithstanding the provisions of Subsection (4) above, warranty services or repairs must be provided at all DuroMax Power Equipment distribution centers that are franchised to service the subject engines.
- (6) The owner must not be charged for diagnostic labor that leads to the determination that a warranted part is, in fact, defective provided that such diagnostic work is performed at a warranty station. (7) DuroMax Power Equipment is liable for damages to other engine components proximately caused by a failure under warranty of any warranted part.
- (8) Throughout the emissions warranty period defined in Subsection (b)(2), DuroMax Power Equipment must maintain a supply of warranted parts sufficient to meet the expected demand for such parts.
- (9) Any replacement part may be used in the performance of any warranty maintenance or repairs and must be provided without charge to the owner such use will not reduce the warranty obligations of DuroMax Power Equipment
- (10) Add-on or modified parts that are not exempted by the Air Resources Board may not be used. The use of any non-exempted add-on or modified parts will be grounds for disallowing a warranty claim. DuroMax Power Equipment will not be liable to warrant failures of warranted parts caused by the use of a non-exempted add-on or modified part.
- (11) DuroMax Power Equipment issuing the warranty shall provide any documents that describe that manufacturer's warranty procedures or policies within five working days of a request by the US EPA & Air Resources Board.

Exhaust Emission Warranty Parts List.

- (1) Fuel Metering System
 - (i) Carburetor and internal parts (and/or pressure regulator or fuel injection system).
 - (ii) Air/fuel ratio feedback and control system.
 - (iii) Cold start enrichment system.
 - (iv) Fuel tank.
- (2) Air induction system
 - (i) Controlled hot air intake system.
 - (ii) Intake manifolds.
 - (iii) Air filter.
- (3) Ignition System
 - (i) Spark Plugs.
 - (ii) Magneto or electronic ignition system.
 - (iii) Spark advance/retard system.
- (4) Exhaust Gas Recirculation (EGR) System
 - (i) EGR valve body, and carburetor spacer if applicable.
 - (ii) EGR rate feedback and control system.
- (5) Air Injection System
 - (i) An air pump or pulse valve.
 - (ii) Valves affecting the distribution of flow.
 - (iii) Distribution manifold.
- (6) Catalyst or Thermal Reactor System
 - (i) Catalytic converter.
 - (ii) Thermal reactor.
 - (iii) Exhaust manifold.
- (7) Particulate Controls
 - (i) Traps, filters, precipitators, and any other device used to capture particulate emissions.
- (8) Miscellaneous Items Used in Above Systems
 - (i) Electronic controls
 - (ii) Vacuum, temperature, and time-sensitive valves and switches.
 - (iii) Hoses, belts, connectors, and assemblies.

DuroMax Power Equipment will furnish with each new engine written instructions for the maintenance and use of the engine by the owner

CUSTOMER SERVICE

Duromax Power Equipment is committed to ensuring that our products perform when they need to. Our generators are your lifeline in the event of an emergency. Should you have any problems, please contact our customer service department:

DUROMAX POWER EQUIPMENT
5800 Ontario Mills Parkway
Ontario, CA 91764

Customer Service: 844-DUROMAX
Customer Service Hours: 8-5 pm PST

Website: www.duromaxpower.com
Email: customerservice@duromaxpower.com

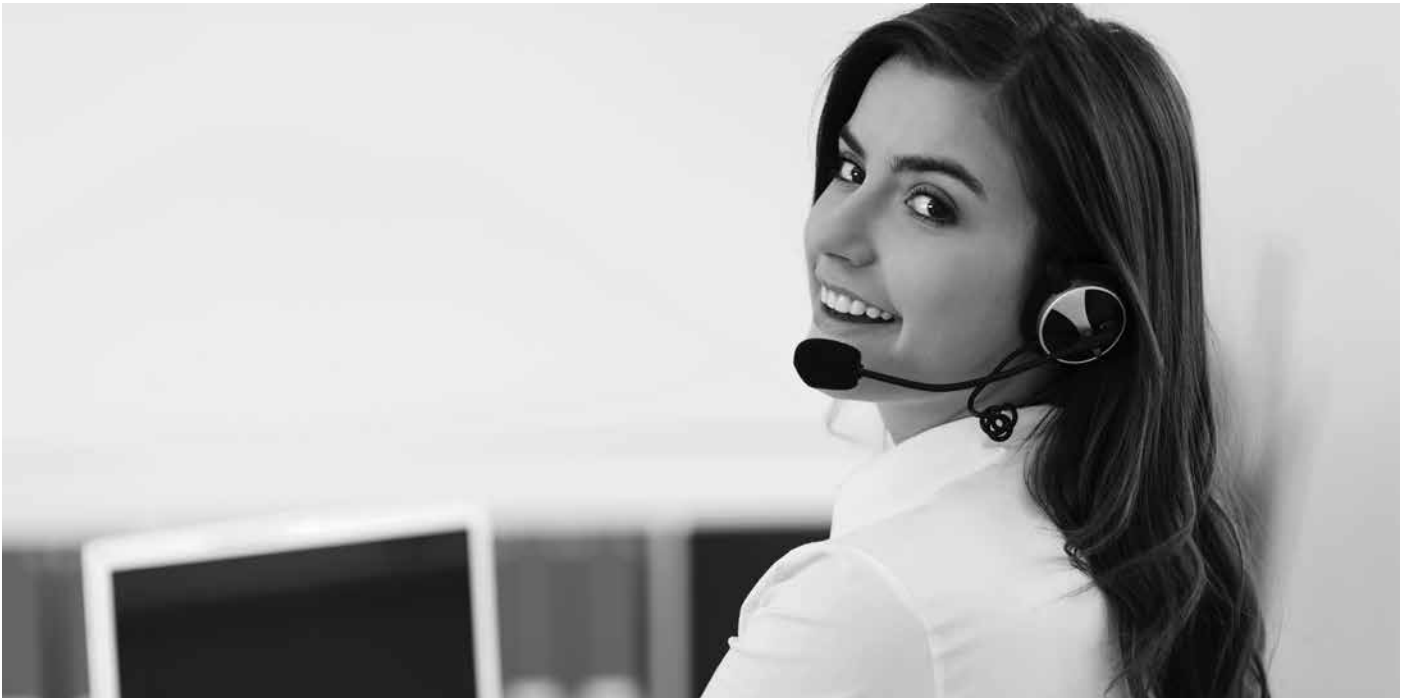





5800 Ontario Mills Parkway
Ontario, CA 91764
United States

844-DUROMAX