



# XP13000E GENERATOR

## User Manual

REV: XP13000E-08032020

This manual provides information regarding the operation and maintenance of these products. We have made every effort to ensure the accuracy of the information in this manual. We reserve the right to change this product at any time without prior notice.

5800 Ontario Mills Pkwy  
Ontario, CA 91764 USA  
www.duromaxpower.com

Call our Customer Care Team Toll Free 8-5pm PST Mon-Fri  
**844-DUROMAX**



# CONTENTS

## 1.

### Introduction

Introduction .....	6
General Safety Procedures .....	7
Quick Start Guide (Gasoline) .....	10
Generator Components .....	12
Package Contents .....	14

## 2.

### Generator Setup

Shipping Braces .....	16
Wheel Kit Installation.....	17
Adding Oil .....	18
Adding Gasoline .....	19
Grounding the Generator .....	20
Grounding the Generator .....	20

## 3.

### Starting the Generator

Checking the Oil .....	22
Check the Gas Level .....	23
Starting the Generator .....	24

## 4.

### Using the Generator

AC Usage .....	28
Connecting a Load to the Generator .....	30
Voltage Selector Switch .....	31
DC Usage.....	32

# CONTENTS

<b>5.</b>	<b>Maintenance and Care</b>	
	Maintenance Schedule.....	<b>34</b>
	Maintenance Log .....	<b>37</b>
	Checking the Oil .....	<b>38</b>
	Changing the Oil.....	<b>39</b>
	Cleaning the Air Filter .....	<b>40</b>
	Spark Plug Maintenance .....	<b>42</b>
	Emptying the Gas Tank .....	<b>44</b>
	Cleaning the Fuel Filter Cup.....	<b>46</b>
	Storage and Transportation .....	<b>47</b>
	Specifications.....	<b>48</b>
<b>6.</b>	<b>Troubleshooting</b>	
	Basic Troubleshooting .....	<b>48</b>
	Changing / Inspecting the Carbon Brushes .....	<b>51</b>
	Changing / Inspecting the AVR .....	<b>53</b>
<b>7.</b>	<b>Warranty</b> .....	<b>56</b>
<b>8.</b>	<b>Contact Information</b> .....	<b>60</b>



# INTRODUCTION

DuroMax has cemented its reputation as one of the markets leading power equipment companies who are headquartered in the US. All of our products are manufactured to the strictest guidelines and go through countless testing in all phases of production.

Evolving our strong engine line, DuroMax has complemented its offerings to include Pressure Washers, Water Pumps, Engines and now offering V-Twin engines. Reliability is the highest standard we hold ourselves to, whether its powering a heater during a winter storm that knocks out power, dewatering a flooded property, or washing away a deck for the summer season



## Notice Regarding Emissions

Engines that are certified to comply with U.S. EPA emission regulations for SORE (Small off Road Equipment), are certified to operate on regular unleaded gasoline, and may include the following emission control systems: (EM) Engine Modifications and (TWC) Three-Way Catalyst (if so equipped).

# GENERAL SAFETY PROCEDURES



## SAFETY ALERT SYMBOL

The safety alert symbol is used with one of the safety words (**DANGER**, **CAUTION**, or **WARNING**) to alert you of hazards. Please pay attention to these hazard notices both in this manual and on the generator.

### Please familiarize yourself with the following safety symbols and words:

- **DANGER:** Indicates a hazard that will result in serious injury or death if instructions are not followed.
- **WARNING:** Indicates a strong possibility of causing serious injury or death if instructions are not followed.
- **CAUTION:** Indicates a possibility of personal injury or equipment damage if instructions are not followed.



**DANGER:** This generator produces poisonous carbon monoxide gas when running. This gas is both odorless and colorless. Even if you do not see or smell gas, carbon monoxide may still be present. Breathing this poison can lead to headaches, dizziness, drowsiness, and eventually death.

- Use outdoors **ONLY** in non-confined areas.
- Keep several feet of clearance on all sides to allow proper ventilation of the generator.



**WARNING:** The exhaust from this product contains chemicals known to the State of California to cause cancer, birth defects, or other reproductive harm.



**WARNING:** This generator produces heat when running. Temperatures near exhaust can exceed 150°F (65°C).

- Do not touch hot surfaces. Pay attention to warning labels on the generator denoting hot parts of the machine.
- Allow generator to cool several minutes after use before touching engine or areas which heat during use.

# GENERAL SAFETY PROCEDURES



**WARNING:** This generator may emit highly flammable and explosive gasoline vapors, which can cause severe burns or even death. A nearby open flame can lead to an explosion even if not directly in contact with gas.

- Do not operate near an open flame.
- Do not smoke near generator.
- Always operate on a firm, level surface.
- Always turn generator off before refueling.
- Allow generator to cool for at least 2 minutes before removing fuel cap. Loosen cap slowly to relieve pressure in tank.
- Do not overfill gas tank. Gas may expand during operation. Do not fill to the top of the tank.
- Always check for spilled gas before operating.
- Empty the gasoline tank before storing or transporting the generator.
- Before transporting, turn fuel valve to the off position and disconnect the spark plug.



**WARNING:** This generator produces a powerful voltage, which can result in electrocution.

ALWAYS ground the generator before using it (see the “Grounding the Generator” portion of the “PREPARING THE GENERATOR FOR USE section).

- Generator should only be plugged into electrical devices, either directly or with an extension cord. NEVER connect to a building electrical system without a qualified electrician. Such connections must comply with local electrical laws and codes. Failure to comply can create a backflow of power, which may result in serious injury or death to utility workers.
- Use a ground fault circuit interrupter (GFCI) in highly conductive areas such as metal decking or steel work. GFCIs are available in-line with some extension cords.
- Do not use uncovered in rainy or wet conditions.
- Do not touch bare wires or receptacles (outlets).
- Do not allow children or non-qualified persons to operate.



# GENERAL SAFETY PROCEDURES

In addition to the above safety notices, please familiarize yourself with the safety and hazard markings on the generator.

<p><b>WARNING</b></p> <p>THIS GENERATOR IS NOT INTENDED TO POWER SENSITIVE ELECTRONIC EQUIPMENT WITHOUT THE AID OF AN APPROPRIATE LINE CONVERTER (SOLD SEPARATELY).</p> <p><b>HIGH VOLTAGE ELECTRICAL</b></p> <p><b>WARNING</b></p>	<p>1. All personnel must wear ANSI approved safety goggles when setting up this generator working with tools and equipment.</p> <p>2. Before using this generator, you must read the Engine Operation, Maintenance, Parts and Gasoline Generator Instructions manual. Read and adhere to all safety warnings to reduce the risk of personal injury and damage to equipment.</p> <p>3. All electrical work, including earth-ground connections, should be completed by a licensed electrician.</p> <p>4. <b>DANGER</b> Generator fuel and fumes are flammable and potentially explosive. Use proper fuel storage and handling procedures while using this generator.</p>	<p>5. Remove any flammable materials next to or from this equipment.</p> <p>6. <b>DANGER</b> Do not smoke, allow sparks, allow flames, or other sources of ignition around the engine, fuel tank, or battery. Fuel vapors are explosive. While charging, batteries emit hydrogen gas which is highly explosive. Do not refill the generator fuel tank while the engine is running.</p> <p>7. Keep access doors on enclosures closed and locked when access is not required.</p> <p>8. Read and adhere to all electrical warnings and precautions discussed in the instruction manuals before setting up and running the generator.</p>	<p>9. <b>DANGER</b> Do not attempt to start the generator engine before it has been checked for sufficient and recommended fuel and oil. Generator battery should be fully charged.</p> <p>10. All maintenance must be performed by a qualified mechanic or licensed electrician.</p> <p><b>DO NOT REMOVE THIS WARNING LABEL</b></p> <p>Made in China</p>
---	---	--	---

**⚠ DANGER**

Using a generator indoors CAN KILL YOU IN MINUTES. Generator exhaust contains carbon monoxide. This is a poison you cannot see or smell.

<p>NEVER use inside a home or garage, EVEN IF doors and windows are open.</p>	<p>Only use OUTSIDE and far away from windows, doors, and vents.</p>



**CAUTION HOT EXHAUST KEEP SAFE DISTANCE**

<p>BURN RISK</p>	<p>CARBON MONOXIDE</p>	<p>4 FEET SAFE DISTANCE</p>
------------------	------------------------	-----------------------------

**DON'T TOUCH**



**HIGH TEMPERATURE**

**DON'T TOUCH**

# QUICK START GUIDE



## 1. Remove shipping braces

The shipping braces prevent engine movement during shipment. Flip the generator over and remove the brightly colored brace between the motor and the frame, and the wood brace under the generator.



## 2. Add oil

The oil fill cap is located on the lower engine block to the right of the recoil start housing. Remove the oil fill cap and fill with 10w30 oil.



## 3. Add gasoline

The fuel cap is located on top of the fuel tank. Fill the tank with fresh unleaded gasoline 87 octane or higher. The tank is full when you see fuel in the bottom of the fuel filter cup. DO NOT overfill the tank.

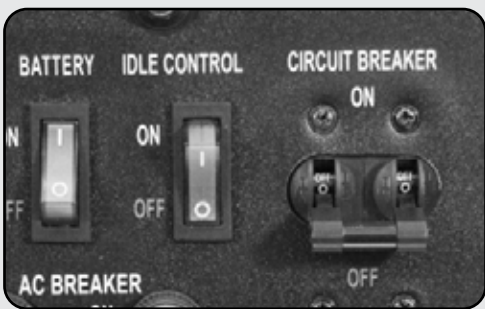

## 4. Turn breaker off

The breaker is located on the right side of the front power panel. Flip the breaker down to prevent accidental load when starting the generator.



## 5. Turn gas valve on

The gas valve is located above the recoil start on the bottom of the fuel tank. Rotate the valve clockwise to the vertical position to turn on the gas supply.

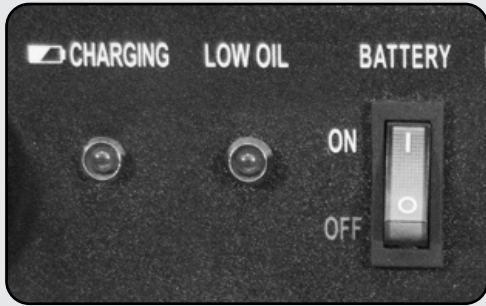

## 6. Turn battery switch on

The battery switch is located on the top center of the main power panel. Turn the switch ON to allow power to the push button start.

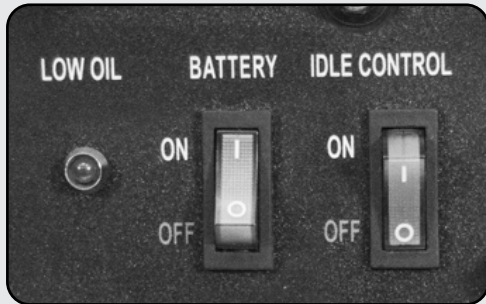

## 7. Turn idle control off

The idle control is located on the top center of the main power panel. Turn the switch OFF to prevent the unit trying to idle down before the engine is warmed up.



## 8. Start generator

The push button start left side of the main power panel. Press the button for 1 second to start the generator.

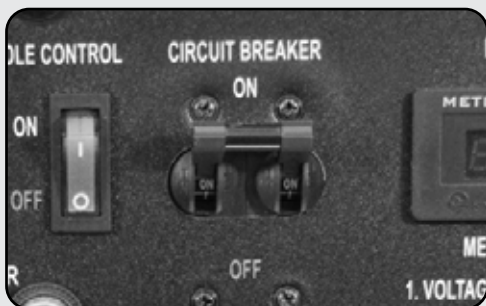

## 9. Turn breaker on

The breaker is located on the right side of the front power panel. Flip the breaker up to allow power to flow to the receptacles.



## 10. Connect devices

Connect your devices to the receptacles on the front panel. Start with the largest loads first.

# GENERATOR COMPONENTS

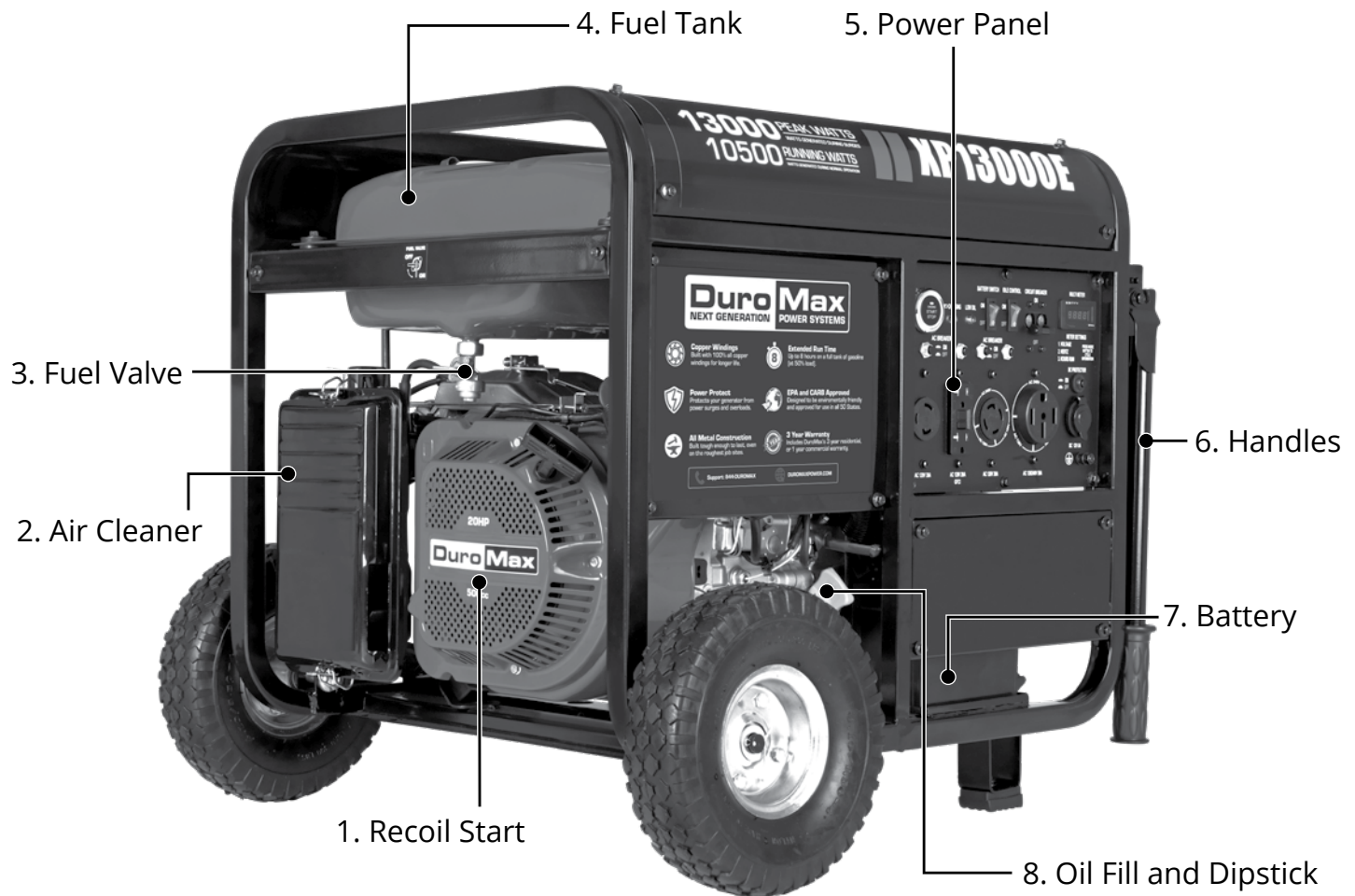

1. **Recoil Start** - Easy Pull Recoil Start to start the engine without the electric start.
2. **Air Cleaner** - a removable, cleanable, oiled, element that cleans the air going into the engine.
3. **Fuel Valve** - On/Off valve that allows gasoline to the fuel switch.
4. **Fuel Tank** - All metal 7.8 Gallon gasoline fuel tank.
5. **Power Panel** - Contains the start switch, plugs, meters, and circuit breakers.
6. **Handles** - Longest handles of any DuroMax Model allow easy movement across any surface.
7. **Battery** - 12V DC 7ah Battery that powers the Electric Start System
8. **Oil Fill and Dipstick** - Use to add or check the oil.
9. **Engine Switch** - Push Button start switch. Press for 1 second to start the generator. Hold for 3 seconds to stop the generator.
10. **Charging Light** - Will light when the generator is charging the onboard battery.
11. **Low Oil Alert** - Will light only if the generator shuts down due to low oil.

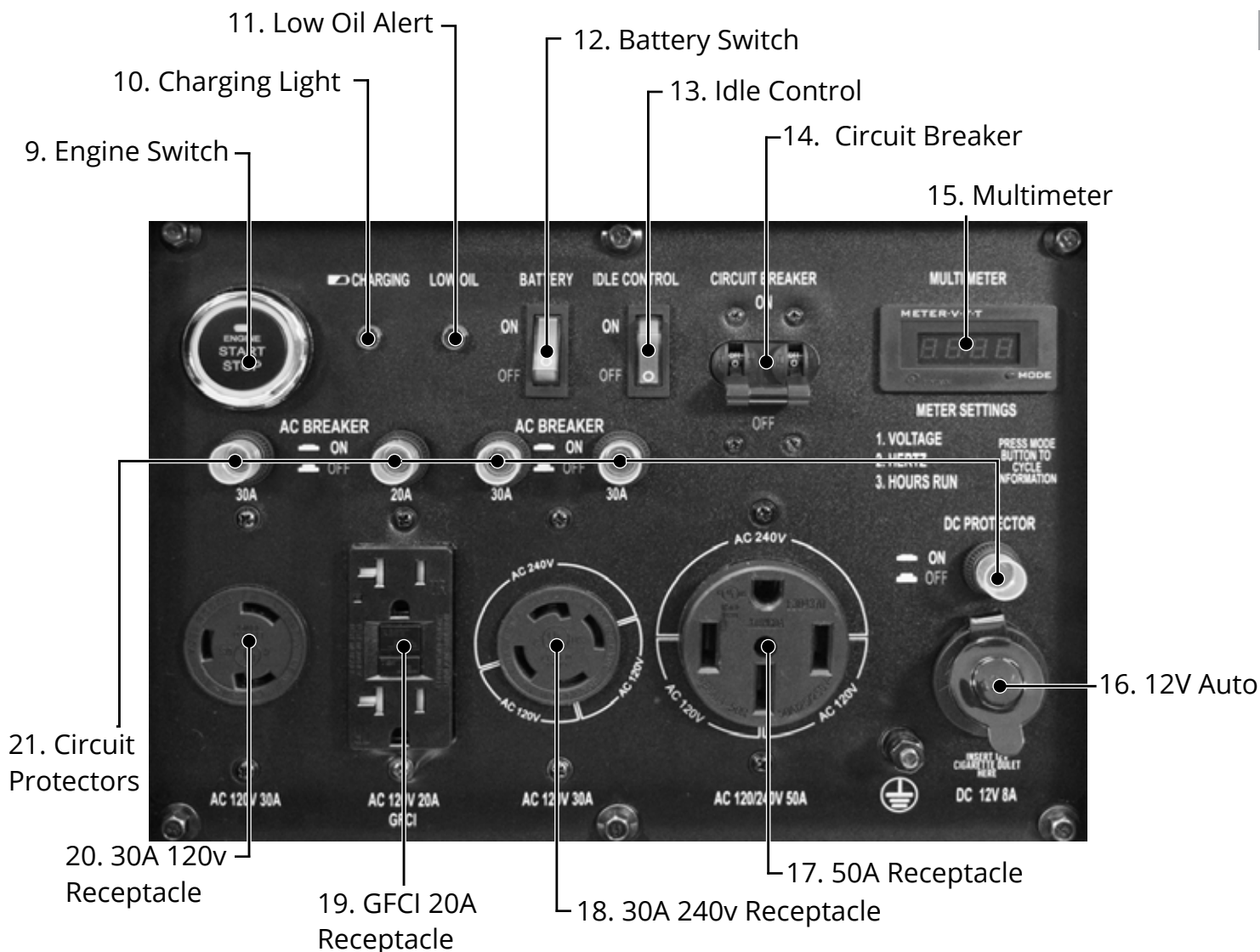

- 12. **Battery Switch** – Prevents battery discharge during storage.
- 13. **Idle Control** - Slows the engine to save fuel and lower noise when no load.
- 14. **Circuit Breaker** - Protects the panel from overload and short circuits.
- 15. **Multimeter** – Displays voltage, hertz, and time running.
- 16. **12v Auto** - Provides a 12v automotive style plug for appliances and chargers.
- 17. **120/240v 4-Prong Receptacle** - Use to connect electrical devices that run 120 or 240 Volt, 60Hz, single phase, AC current (NEMA 14-50)
- 18. **120/240v 4-Prong Twist Lock** - Use to connect electrical devices that run 120 or 240 Volt, 60Hz, single phase, AC current (NEMA 14-30)
- 19. **120v 3-Prong GFCI Receptacle** - Use to connect electrical devices that run 120 Volt, 60Hz, single phase, AC current (NEMA 5-20)
- 20. **120v 3-Prong Twist Lock** - Use to connect electrical devices that run 120 Volt, 60 Hz, single phase, AC current (L5-30).
- 21. **Circuit Protectors** - Protects the receptacles from overload.

# PACKAGE CONTENTS

Your generator comes with the items listed below. Please check to see that all of the following items are included with your generator.



**Double Sided  
Screw Driver**

Phillips and slot blade screwdriver used for generator maintenance.



**Spanner**

Assorted wrenches used in generator maintenance and assembly. Commonly 8mm, 10mm, 13mm, and 15mm.



**Spark Plug Wrench**

Used in spark plug maintenance, inspection, and installation.



**Oil Funnel w/ hose**

Used to add oil to the generator without messy spills.



**Plug Ends**

Plug heads for the receptacles found on the generator are included to make or rewire your own cords.

- Note: Actual tools may differ in appearance or design from image shown.



# GENERATOR SETUP

Proper setup of your generator will get you going as soon as possible while making sure you and your equipment are safe and cared for.





# GENERATOR SETUP

## Connect the Battery

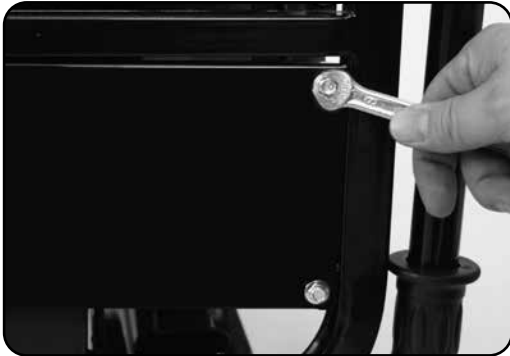

### 1. Remove the battery cover

- a. Remove the battery cover plate using the wrench from the toolkit.

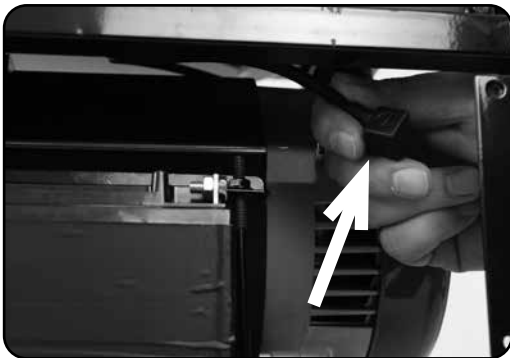

### 2. Locate the negative cable

- a. Locate the negative battery cable above and behind the battery. One side is connected to ground and the other end needs to be connected to the battery.
- b. Route the free end to the negative battery terminal.



### 3. Connect the negative cable

- a. Push the black rubber boot up the wire to expose the connector.
- b. Securely connect the free end of the battery cable to the negative battery terminal using the screw and nut from the battery with the screwdriver and wrench from the toolkit.



### 4. Reinstall the battery plate

- a. Cover the connected terminal with the black rubber boot.
- b. Reinstall the battery cover plate using the wrench from the toolkit.

# GENERATOR SETUP

## Step 1 - Remove Shipping Braces



### 1. Unpack

- Remove the generator from the box.
- Place the largest piece of packing foam on a flat surface.
- Flip the generator upside down on the pad.

**CAUTION: NEVER** Attempt this if you have put fuel or oil in the generator.



### 2. Remove braces

- Completely remove each of the 4 bolts holding the orange metal brace in place.
- Remove the brace.
- Cut the nylon tie strap holding the wood brace in place.
- Grab the end of the second brace and pull it out.
- This piece is no longer needed and can be discarded.

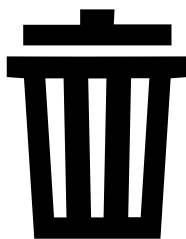

Note: Shipping braces can be thrown away. They will not be needed again.

## Step 2 - Wheel Kit Installation (Optional)



### 1. Install support legs

Secure the support legs to the frame with provided bolts and lock nuts.

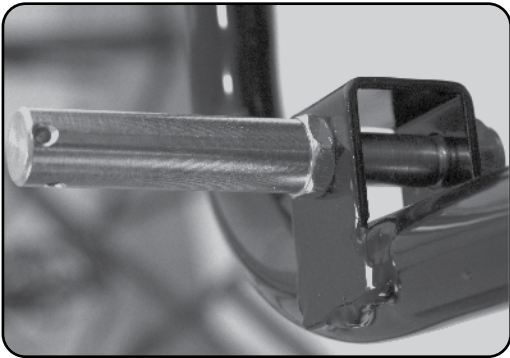

### 2. Install wheels

- a. Insert wheel bolt through frame and secure with provided nut.
- b. Slide one wheel over each axle end and secure with the provided retaining pins.

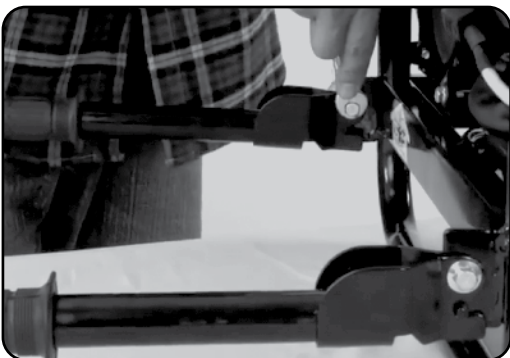

### 3. Install Handles

Attach the handles to the brackets on the frame using the provided bolts and nuts.

**Do not over tighten the handles, it will prevent free movement.**

# GENERATOR SETUP (CONTINUED)

## Step 3 - Adding Oil

The generator requires engine oil to operate properly. The generator, when new from the package contains no oil in the crankcase\*. You must add the proper amount of oil before operating the generator for the first time. This amount is equal to the oil capacity of the engine crankcase:

<b>Model Number</b>	XP13000E
<b>Engine Oil Capacity</b>	40.5 fl. oz (1.2L)

**WARNING: Do not apply engine oils with additives or 2-stroke gasoline engine oils.** They don't have enough lubrication, and may shorten the engine's service life.

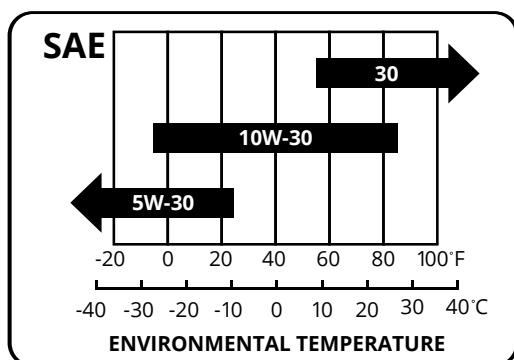

**Engine oil recommended: SAE 10W-30.** Viscosity varies with regions and temperatures. Choose your oil viscosity using the chart to the left.

\* A small amount of oil from factory testing may be present on arrival.



### 1. Add oil

- Make sure the generator is on a level surface.
- Unscrew the oil filler/dipstick cap from the engine .
- Using a funnel, add the appropriate amount of oil into the crankcase. You will know the crankcase is full when the oil level has reached the lower lip of the opening you have just poured the oil into.
- Replace oil filler cap.



**WARNING: DO NOT overfill the crankcase. This may damage the motor and shorting overall life of your generator.**

## Step 4 - Adding Gasoline



**WARNING: Gasoline and gas fumes are highly flammable.**

- Do not fill tank near an open flame.
- Do not overfill. Always check for fuel spills.

To ensure that the generator runs smoothly use only FRESH, UNLEADED GAS WITH AN OCTANE RATING OF 87 OR HIGHER.



### 2. Add Gasoline

- Make sure the generator is on a level surface.
- Unscrew gas cap and set aside (NOTE: the gas cap may be tight and hard to unscrew).
- Slowly add unleaded gasoline to the fuel tank. Be careful not to overfill. Please refer to the chart below to find the gas capacity of your generator model. The fuel gauge on the top of the gas tank indicates how much gasoline is in the generator gas tank.
- Replace fuel cap and wipe up any spilled gasoline with a dry cloth.

**NOTE: Gas can expand. Do not fill the gas tank to the very top. Leave a minimum of 1.5 in of open space.**

#### IMPORTANT:

- Never use an oil/gasoline mixture. Never use old gas.
- Avoid getting dirt or water in the fuel tank.
- Gas can age in the tank and make it hard to start up the generator in the future.
- Never store generator for extended periods of time with fuel in the tank.



<b>Model Number</b>	XP13000E
<b>Gas Tank Capacity</b>	7.9 US Gallons (30L)

# GENERATOR SETUP (CONTINUED)

## Step 5 - Grounding the Generator



### 1. Attach grounding wire

- Ground the generator by tightening the grounding nut against a grounding wire.
- Connect the other end to a copper or brass grounding rod that's driven into the earth.

A generally acceptable grounding wire is a No. 12 AWG (American Wire Gauge) stranded copper wire.



Grounding codes can vary by location. Please contact a local electrician to check the grounding regulations for your area.



**WARNING: Failure to properly ground the generator can result in electrocution.**

### High Altitude Operation

At high altitude, the standard carburetor air/fuel mixture will be too rich. Performance will decrease, and fuel consumption will increase. A very rich mixture will also foul the spark plug and cause hard starting. Operation at an altitude that differs from that at which this engine was certified, for extended periods of time, may increase emissions. High altitude performance can be improved by specific modifications to the carburetor. If you always operate your generator at altitudes above 5,000 feet (1,500 meters), have a dealer perform this carburetor modification. This engine, when operated at high altitude with the carburetor modifications for high altitude use, will meet each emission standard throughout its useful life. Even with carburetor modification, engine horsepower will decrease about 3.5% for each 1,000-foot (300-meter) increase in altitude. The effect of altitude on horsepower will be greater than this if no carburetor modification is made.

When the carburetor has been modified for high altitude operation, the air/fuel mixture will be too lean for low altitude use. Operation at altitudes below 5,000 feet (1,500 meters) with a modified carburetor may cause the engine to overheat and result in serious engine damage.



# STARTING THE GENERATOR

If this is not your first time using the generator there are still steps you should take to prepare it for operation each time you use it.

**IMPORTANT:** At this point you should be familiar with the procedures described in the first portion of this section entitled “GENERATOR SETUP” If you have not yet read this section, go back and read it now.

# BEFORE YOU START YOUR GENERATOR

## Step 1 - Check the oil



### 1. Check the oil

The generator is equipped with an automatic shutoff to protect it from damage due to low oil. Nonetheless, you should check the oil level of the engine before each use to ensure that the engine crankcase has a sufficient amount.

To check the oil level:

- a. Make sure the generator is on a level surface.
- b. Unscrew the oil filler/dipstick cap.
- c. With a dry cloth, wipe the oil off of the stick on the inside of the cap.
- d. Insert the dipstick as if you were replacing the cap and then remove again. There should now be oil on the stick. If there is no oil on the stick, or oil only at the very end of the stick, you should add oil until the engine crankcase is filled (see “Adding Oil” portion of the “Maintenance” section).
- e. Be sure to replace the cap when finished checking oil.

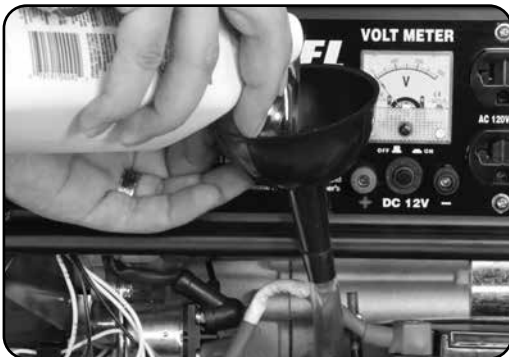

**NOTE: The oil capacity for your generator can be found in the “Specifications” section of this manual.**



## Step 2 - Check the gas level



### 1. Check Fuel Level

Before starting the generator, check to see that there is sufficient gasoline in the fuel tank. The fuel gauge on top of the tank will give a rough estimate of the gasoline level. The gauge will appear white then fill red as the tank is filled.

Note: Fuel gauge may not register with less than 1/3 fuel tank full.



**WARNING: Gasoline and gasoline fumes are highly flammable.**

- Do not fill tank near an open flame.
- Always allow engine to cool for several minutes before refueling.
- DO NOT overfill fuel tank. Fuel expands when shaken or heated. ALWAYS leave 1½" space or more at the top of the tank.
- ALWAYS use fresh fuel or stabilized fuel. Old gasoline (older than 30 days) can cause permanent damage to the fuel system.
- Always check for fuel spills.

# STARTING THE GENERATOR

## Starting the Generator

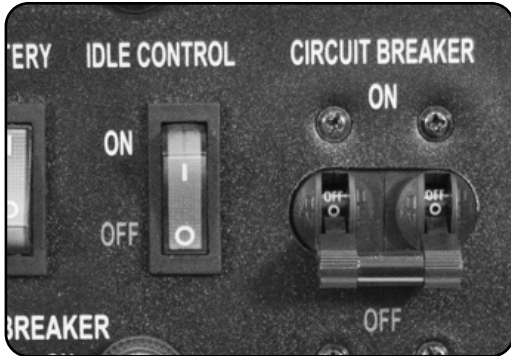

### 1. Turn breaker OFF

The breaker is located on the right side of the front power panel. Flip the breaker down to prevent accidental load when starting the generator.

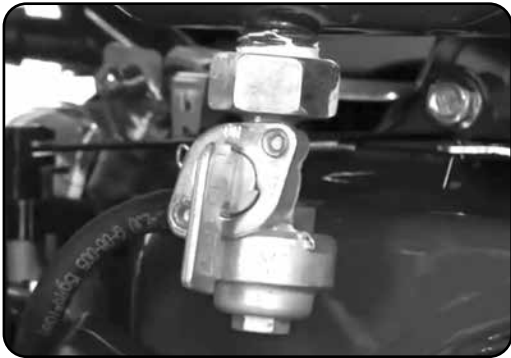

### 2. Turn gas valve on

The gas valve is located above the recoil start on the bottom of the fuel tank. Rotate the valve clockwise to the vertical position to turn on the gas supply.



### 3. Turn battery switch ON

The battery switch is located on the top center of the main power panel. Turn the switch ON to allow power to the push button start.



### 4. Turn idle control OFF

When the engine starts, allow the engine switch to return to the ON position.

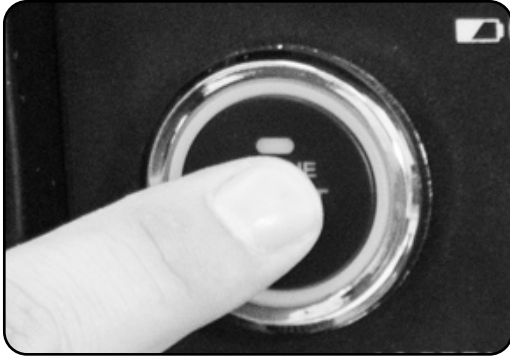

## 5. Start the Generator

The push button start left side of the main power panel. Press the button for 1 second and release to start the generator.

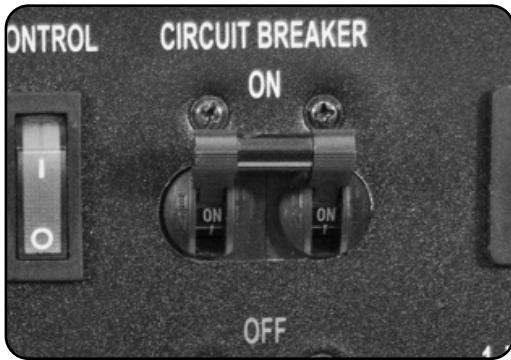

## 6. Turn breaker ON / Connect

The breaker is located on the right side of the front power panel. Flip the breaker up to allow power to flow to the receptacles. Connect your devices to the receptacles on the front panel. Start with the largest loads first.



**CAUTION:** Disconnect all electrical loads from the generator before attempting to start!



**WARNING:** Operating the starter motor for more than 5 seconds can damage the motor. If the engine fails to start, release the switch and wait 10 seconds before operating the starter again.





# USING THE GENERATOR

If this is not your first time using the generator there are still steps you should take to prepare it for operation each time you use it.

**IMPORTANT:** At this point you should be familiar with the procedures described in the first portion of this section entitled “GENERATOR SETUP” If you have not yet read this section, go back and read it now.

# USING THE GENERATOR

## AC Usage

- You may connect electrical devices running on AC current according to their wattage requirements.
- The chart below shows the rated and surge wattage of your generator according to its model number.
- The rated wattage corresponds to the maximum wattage the generator can output on a continuous basis.
- The surge wattage corresponds to the maximum amount of power the generator can output for a short period of time. Many electrical devices such as refrigerators require short bursts of extra power, in addition the rated wattage listed by the device, to stop and start their motors. The surge wattage ability of the generator covers this extra power requirement.

Fuel Source	Rated (Running Wattage)	Surge (Peak) Wattage
Gasoline	10500	13000

The total running wattage requirement of the electrical devices connected to the generator should not exceed the rated wattage of the generator itself. To calculate the total wattage requirement of the electrical devices you wish to connect, find the rated (or running) wattage of each device. This number should be listed somewhere on the device or in its instruction manual.

If you cannot find this wattage, you may calculate it by multiplying the Voltage requirement by the Amperage drawn:  $\text{Watts} = \text{Volts} \times \text{Amps}$ . If these specifications are not available you may estimate the Watts required by your device by using the chart on the next page.

Once you have found the rated wattage requirement of each electrical device, add these numbers to find the total rated wattage you wish to draw from the generator. If this number exceeds the rated wattage of the generator, DO NOT connect all these devices. Select a combination of electrical devices, which has a total rated wattage lower than or equal to the rated wattage of the generator.

Tool or Appliance	Rated (Running) Watts	Additional Surge Watts
Electric water heater (40 gal)	4000	0
Hot plate	2500	0
Radial arm saw	2000	2000
Electric Stove	1500	0
Circular Saw	1500	1500
Air compressor (1 HP)	1500	3000
Window air conditioner	1200	1800
Miter saw	1200	1800
Microwave	1000	2000
Well water pump	1000	1500
Reciprocating saw	960	1040
Sump pump	800	1200
Refrigerator freezer	800	1200
Furnace blower	800	1300
Computer	800	0
Electric drill	600	900
Television	500	0
Deep freezer	500	800
Garage door opener	480	600
Stereo	400	0
Box fan	300	600
Clock radio	300	0
Security system	180	0
DVD Player	100	0
Common light bulb	75	0



**CAUTION** - The generator can only run at its surge wattage capacity for a very short time. Connect only electrical devices requiring a rated (running) wattage equal to or less than the rated wattage of the generator. Never connect devices requiring a rated wattage equal to the surge wattage of the generator.

*NOTE: The above wattage figures are estimates only.  
Try to check the wattage listed on your electrical devices before consulting this chart.*

# USING THE GENERATOR (CONTINUED)

## Connecting a load to the generator

**NOTE:** Be sure to attach devices to the correct receptacle (outlet).

- 120v devices can be directly connected to the 120v ONLY receptacles.
- 120v devices can be connected to the 120/240v receptacle using an appropriate adapter.
- 240v devices can ONLY be connected the 240v receptacle.



**CAUTION:** Do not connect 50Hz or 3-phase loads to the generator.

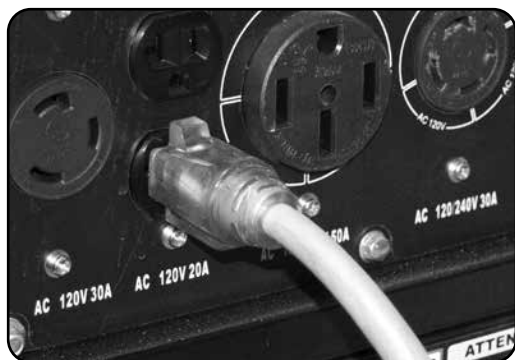

### 1. Plug in devices

Plug in devices to the appropriate receptacle. When using the generator in 120/240v mode, balance the load as closely as possible. Placing more load on one side of the circuit will reduce the breaker trip period.



### 2. Turn breaker on

Flip the circuit breaker up to the on position to allow power to the receptacles.



### 3. Turn on connected devices

Start or turn on appliances starting with the biggest loads first.



## Choosing the right power cord

Long or thin cords can drain the power provided to an electrical device by the generator. When using such cords, allow for a slightly higher rated wattage requirement for the electrical device. See table below for recommended cords based on the power requirement of the electrical device.

DEVICE REQUIREMENTS		WIRE GAUGE BY LENGTH (ft.)				
AMPS	WATTS (120/240V)	10	25	50	100	150
5	600/1200	18	16	14	12	10
10	1200/2400	16	14	12	10	8
15	1800/3600	14	12	10	8	6
20	2400/4800	12	10	8	6	4
25	3000/6000	10	8	6	4	4
30	3600/7200	8	6	4	4	NR
40	4800/9600	6	4	4	NR	NR
50	6000/1200	4	4	2	NR	NR
<b>*NR = NOT RECOMMENDED</b>						

# USING THE GENERATOR (CONTINUED)

## DC Usage



**CAUTION:** The DC receptacle is for 12 Volt automotive-type appliances only. Do not connect any other device to this receptacle.



### 1. Start the generator

The push button start left side of the main power panel. Press the button for 1 second and release to start the generator.



### 2. Connect the 12v appliance

Use the standard 12v automotive plug to connect to chargers, tools, appliances, and more.

## Idle Control Usage



### 1. Idle Control

The idle control feature lowers the RPM of the generator when there is no load to save gas and decrease engine noise.

When a load is applied the engine will resume normal speed to provide usable power.

Turn on the idle control when using intermittent loads like power tools and air compressors.



**WARNING: Power is unusable when idle control is engaged.**

DO NOT use the idle control function when using the generator for backup house power.

- Idle control function will cause massive fluctuations in voltage and hertz.
- Low amperage loads may not trigger the idle up function.

# USING THE GENERATOR (CONTINUED)

## Using the Digital Multimeter



When the generator is started the display will read the current voltage. Press the MODE button to cycle through the multimeter functions.

### 1. Voltage

Displays the current voltage in Volts. American power is 220v - 240v (+/- 10%).

### 2. Frequency

Displays the current frequency in Hertz. American power is 60 Hz (+/- 10%)

### 3. Hours Running

Displays the current running time in Hours. Hold down the MODE button to reset.

### 4. Hours Total

Displays the total running time in Hours.



# MAINTENANCE AND CARE

Proper maintenance and storage of your generator is essential to ensure trouble free use of your generator when you need it.

By following the maintenance and care requirements, you can keep your generator running smooth and efficient for years to come.

# MAINTENANCE AND CARE

Proper routine maintenance of your generator is essential for safe, economical, and trouble-free operation. It will also help reduce air pollution.



**WARNING: Improper maintenance, or failure to correct a problem before operation, can cause a malfunction in which you can be seriously injured or killed. Always follow the inspection and maintenance recommendations and schedules in this instruction manual.**

- Make sure the engine is off before you begin any maintenance or repairs.
- Let the engine and exhaust system cool before touching.
- To reduce the possibility of fire or explosion, be careful when working around gasoline. Use only a nonflammable solvent, not gasoline, to clean parts. Keep cigarettes, sparks, and flames away from all fuel related parts.

## Maintenance Schedule

Remember that this schedule is based on the assumption that your machine will be used for its designed purpose. Sustained high-load, high temperature operation, or use in unusually wet or dusty conditions, will require more frequent service.

SERVICE		REGULAR SERVICE PERIOD				
		BEFORE EACH USE	EVERY MO. OR 20 HRS	EVERY 3 MO. OR 50 HRS	EVERY 6 MO. OR 100 HRS	EVERY 12 MO. OR 300 HRS
ENGINE OIL	CHECK	■				
	CHANGE		■			
AIR CLEANER	CHECK	■				
	CHANGE			■		
SEDIMENT CUP	CLEAN				■	
SPARK PLUG	CLEAN-ADJUST				■	
	REPLACE					■
SPARK ARRESTOR	CLEAN				■	
IDLE SPEED	CHECK / ADJUST					■
VALVE CLEARANCE	CHECK-ADJUST					■
COMBUSTION CHAMBER	CLEAN	<b>500 HOURS</b>				
FUEL TANK / FILTER	CLEAN				■	
FUEL TUBE	CHECK	<b>EVERY 24 MO. (REPLACE IF NECESSARY)</b>				
<b>TO BE PERFORMED AT EVERY MONTH INDICATED OR HOUR INTERVAL WHICH EVER COMES FIRST</b>						

# MAINTENANCE LOG

Date	Generator Hours	Maintenance Performed

# MAINTENANCE AND CARE (CONTINUED)

## Checking the oil



### 1. Check the oil

The generator is equipped with an automatic shutoff to protect it from damage due to low oil. Nonetheless, you should check the oil level of the engine before each use to ensure that the engine crankcase has a sufficient amount.

To check the oil level:

- a. Make sure the generator is on a level surface.
- b. Unscrew the oil filler/dipstick cap.
- c. With a dry cloth, wipe the oil off of the stick on the inside of the cap.
- d. Insert the dipstick as if you were replacing the cap and then remove again. There should now be oil on the stick. If there is no oil on the stick, or oil only at the very end of the stick, you should add oil until the engine crankcase is filled (see “Adding Oil” portion of the “Maintenance” section).
- e. Be sure to replace the cap when finished checking oil.

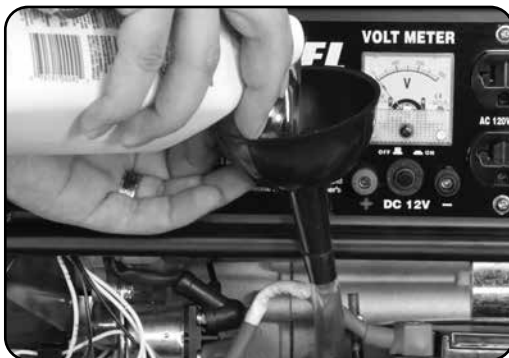

**NOTE: The oil capacity for your generator can be found in the “Specifications” section of this manual.**



# Changing the oil

Worn out or dirty oil does not cool the generator properly and can lead to catastrophic engine damage.

In addition to regular oil changes, it is necessary to drain the oil from the crankcase if it has become contaminated with water or dirt.



## 2. Remove drain plug

Using a 10 mm hex wrench, unscrew the oil drain plug, which is located on the crankcase underneath the oil filler/dipstick cap.

Allow all the oil to drain from the generator.



## 2. Drain oil

Drain oil into an approved oil disposal container. Contact your local auto parts store for information on oil disposal.



## 3. Replace drain plug

Replace the oil drain plug and tighten with a 10 mm hex wrench.

# MAINTENANCE AND CARE (CONTINUED)

## Cleaning the air filter

Routine maintenance of the air cleaner helps maintain proper airflow to the carburetor. Check that the air cleaner is free of excessive dirt after every use.

Note: Improper maintenance may cause less air to enter the engine or dirty air to enter the engine causing overheating and engine wear.



### 1. Open filter cover

Unhinge the clasps at the top and bottom of the air cleaner cover.



### 2. Remove filter element

Remove the sponge-like elements from the casing.



### 3. Wipe out filter casing

Wipe the dirt from inside the empty air cleaner casing.



## 4. Wash filter element

Wash the sponge-like elements in household dish detergent and warm water.



## 5. Dry filter element

Allow the elements to dry completely.



## 6. Add engine oil to elements

Soak the dry elements in a small amount of engine oil. Ring out any excess oil.

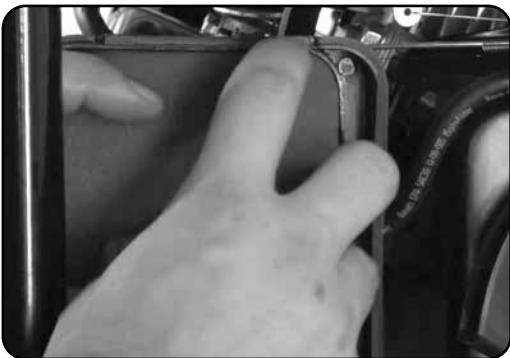

## 7. Replace elements in casing

Replace the sponge-like elements in the air cleaner casing and replace the cover.

# MAINTENANCE AND CARE (CONTINUED)

## Spark Plug Maintenance

The spark plug is important for proper engine operation. A good spark plug should be intact, free of deposits, and properly gapped.

Improper maintenance may cause reduced fuel economy, misfires, trouble starting, or damage to the spark plug threads.

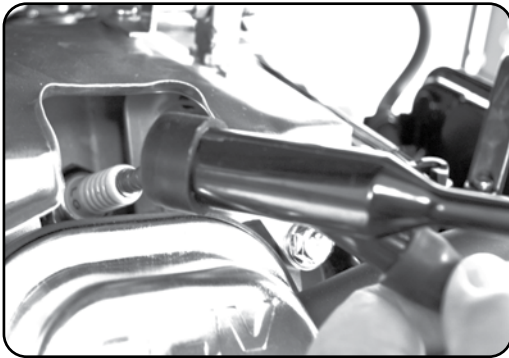

### 1. Remove spark plug cap

Pull on the spark plug cap to remove it.



### 2. Remove spark plug

Unscrew the spark plug from the generator using the spark plug wrench included with this product.



### 3. Inspect spark plug

Visually inspect the spark plug. If it is cracked or chipped, discard and replace with a new spark plug. We recommend using a F6RTC spark plug such as NGK BPR5ES.



## 4. Measure plug gap

Measure the plug gap with a gauge. The gap should be 0.7-0.8 mm (0.028-0.031 in).



## 5. Clean and re-gap

If you are re-using the spark plug, use a wire brush to clean any dirt from around the spark plug base and then re-gap the spark plug.



## 6. Replace spark plug

Screw the spark plug back into its place on the generator using the spark plug wrench.



## 7. Replace spark plug cap

Replace the spark plug cap.

# MAINTENANCE AND CARE (CONTINUED)

## Emptying the Gas Tank

Before storing your generator for extended periods of time, you should drain your generator of gasoline.



**CAUTION:** Do not store fuel from one season to another. Gasoline sold at the pump today contains additives such as ethanol that even when stored properly may damage the fuel system components.



### 1. Shut fuel valve off

Turn the fuel valve to the "OFF" position.



### 2. Remove fuel filter cup

Remove the fuel filter cup (see "Removing the Fuel Filter Cup" earlier in this section).



### 3. Empty fuel filter cup

Empty the fuel filter cup of any fuel.



## 4. Drain gas from generator

With a receptacle underneath the generator to catch the gas, turn the fuel valve to the “ON” position. Drain all the gas from the generator.



## 5. Shut fuel valve off

Turn the fuel valve to the “OFF” position.



## 6. Replace fuel filter cup

Reinstall the fuel filter cup.



## 7. Store emptied gas

Store the emptied gasoline in a suitable place and add fuel stabilizer to keep fuel fresh and usable.

# MAINTENANCE AND CARE (CONTINUED)

## Cleaning the fuel filter cup



### 1. Shut fuel valve off

Turn the fuel valve to the "OFF" position.



### 2. Remove fuel filter cup

Unscrew the fuel filter cup from the fuel valve using a wrench. Turn the valve towards you to unscrew



### 3. Clean filter cup

Clean the cup of all sediment using a rag or brush.



### 4. Replace fuel filter cup

Reinstall the fuel filter cup.



## Storage and Transportation



**CAUTION: Never place any type of storage cover on the generator while it is still hot.**

When transporting your generator:

- Empty the gas tank (see “Emptying the Gas Tank” in the “Maintenance” section).
- Disconnect the spark plug.
- Do not obstruct any ventilation openings & keep the generator in a cool dry area.

Storage Period	Storage Preparation
<p><b>If you plan on starting the same day.</b></p>	<ol style="list-style-type: none"> <li>1. Turn off the main breaker.</li> <li>2. Allow the unit to run 3 - 5 minutes.</li> <li>3. Turn off the key.</li> <li>4. Store.</li> </ol>
<p><b>If you plan on starting the unit again within 30 days.</b></p>	<ol style="list-style-type: none"> <li>1. Turn off the main breaker.</li> <li>2. Allow the unit to run 3 - 5 minutes.</li> <li>3. Turn off the fuel valve.</li> <li>4. Allow the unit to stall out.</li> <li>5. Turn off the key.</li> <li>6. Add fuel stabilizer to the gas remaining in the tank.</li> <li>7. Store.</li> </ol>
<p><b>If you do not plan to start the unit for longer than 30 days.</b></p>	<ol style="list-style-type: none"> <li>1. Turn off the main breaker.</li> <li>2. Allow the unit to run 3 - 5 minutes.</li> <li>3. Turn off the fuel valve.</li> <li>4. Allow the unit to stall out.</li> <li>5. Turn off the key.</li> <li>6. Drain the fuel tank (See “Emptying the Gas Tank” in the “Maintenance” section)</li> <li>7. Drain the carburetor               <ol style="list-style-type: none"> <li>a. Remove the drain bolt from the carburetor.</li> <li>b. Drain the small amount of remaining fuel from the carburetor bowl.</li> </ol> </li> <li>8. Oil the cylinder               <ol style="list-style-type: none"> <li>a. Remove the spark plug.</li> <li>b. Put 2 tbsp. of 10w30 motor oil directly into the spark plug hole</li> <li>c. Pull the recoil start one time.</li> <li>d. Replace the plug.</li> </ol> </li> <li>9. Remove the battery and place on tender indoors.</li> </ol>

# SPECIFICATIONS

<b>AC Rated Wattage</b>	10500W	
<b>AC Surge Wattage</b>	13000W	
<b>AC Rated Voltage</b>	120/240V	
<b>AC Rated Frequency</b>	60 Hz	
<b>AC Phase</b>	Single	
<b>DC Voltage</b>	12V	
<b>DC Amperage</b>	8.3A	
<b>Dimensions</b>	LENGTH	28in.
	WIDTH	23in.
	HEIGHT	23in.
<b>Engine Type</b>	4-Stroke OHV Forced-Air	
<b>Ignition System</b>	Non-Contact Transistor	
<b>Displacement</b>	500cc	
<b>Starting Type</b>	Electric	
<b>Fuel Tank Capacity</b>	7.9 US Gal. (30L)	
<b>Oil Capacity</b>	40.5 fl. oz. (1.1L)	
<b>Run Time @ 50% (Gasoline)</b>	8 hr.	
<b>Run Time @ 50% (Propane)</b>	5 hr. (5 Gallon)	
<b>Noise Level</b>	<74db	



# TROUBLESHOOTING

This section of the manual is to help you troubleshoot problems with your generator.

# TROUBLESHOOTING

Mode	Description	
<b>Engine will not start</b>	Engine Switch is "Off"	Set engine switch to "run"
	Fuel Valve is "Closed"	Turn fuel valve to "open"
	Choke is open.	Close the choke
	Engine is out of fuel	Add fuel
	Fuel is old or contaminated	Change fuel
	Spark Plug is dirty	Clean spark plug
	Spark Plug is broken	Replace spark plug
	Generator is not level	Move generator to a level surface
	Oil is low	Add / change oil
<b>Engine runs, but there is no electrical output.</b>	Circuit Breaker is "Off"	Turn "on" circuit breaker
	Wiring connection is bad	Replace extension cord(s)
	Device connected to generator is malfunctioning	Disconnect malfunctioning device
<b>Generator runs, but does not support all electrical devices connected.</b>	Generator is overloaded	Disconnect 1 or more items to reduce the load
	Device connected to generator is bad	Disconnect malfunctioning device
	Air cleaner is dirty	Clean / replace the air filter

## Changing / Inspecting the Carbon Brushes

The carbon brushes in conjunction with the AVR regulates power from the generator. The carbon brushes are wearable parts and should be inspected every 250 running hours.

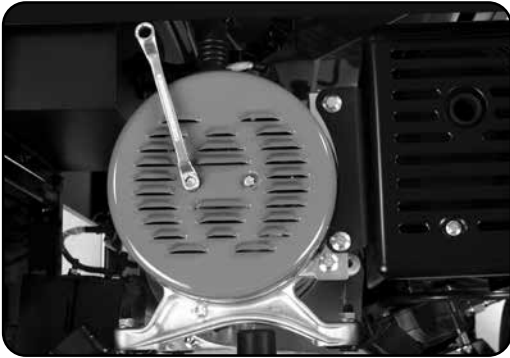

### 1. Remove generator cover

Remove the 2 bolts of the generator cover then pull the cover off the generator.



### 2. Remove bolt from brush

Remove the bolt holding the carbon brush.



### 3. Disconnect AVR wires

Remove the two wires from the AVR on the carbon brush

# TROUBLESHOOTING (CONTINUED)

## Changing / Inspecting the Carbon Brushes (Cont.)

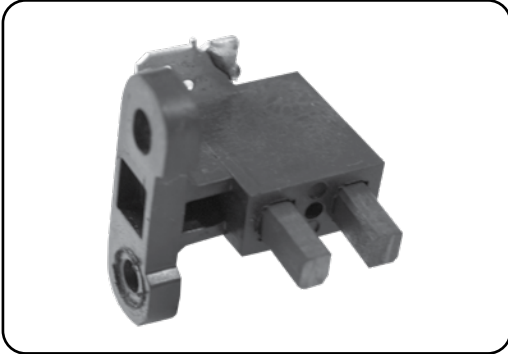

### 4. Install new brush

Install new carbon brush with bolt.

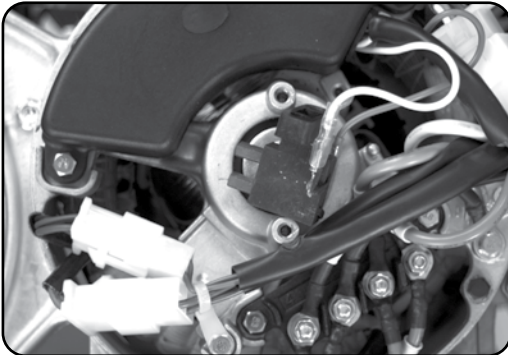

### 5. Connect AVR wires

Insert and connect the 2 wires from the AVR, be sure to connect + and - correctly.

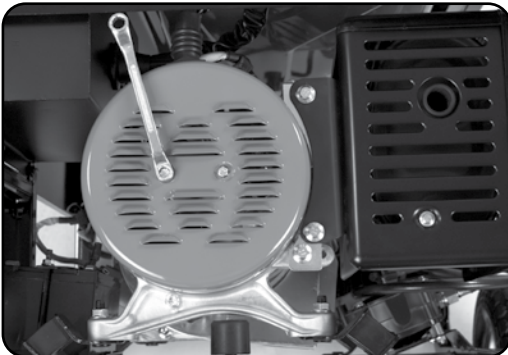

### 6. Replace generator cover

Replace the back cover of the generator and secure with the 2 bolts.

## Changing / Inspecting the AVR

The carbon brushes in conjunction with the AVR regulates power from the generator. If the generator is overheated or overloaded, the AVR may be damaged and require replacement.

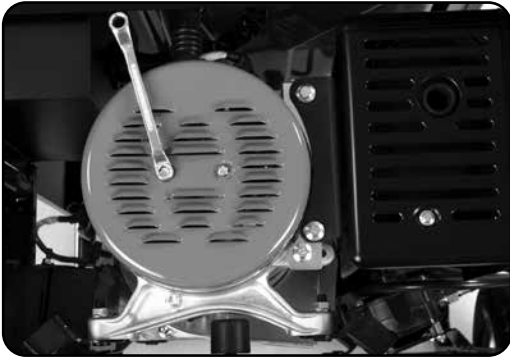

### 1. Remove generator cover

Remove the 2 bolts of the generator cover then pull the cover off the generator.



### 2. Remove AVR bolts

Remove the 2 bolts holding the AVR.



### 3. Disconnect AVR wire clip

Disconnect the wire clip.

# TROUBLESHOOTING (CONTINUED)

## Changing / Inspecting the AVR (Continued)

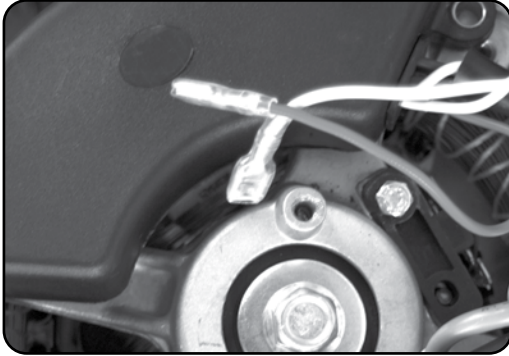

### 4. Disconnect wires from brush

Remove the 2 wires from the AVR on the carbon brush.



### 5. Install new AVR

Install the new AVR with the 2 bolts.

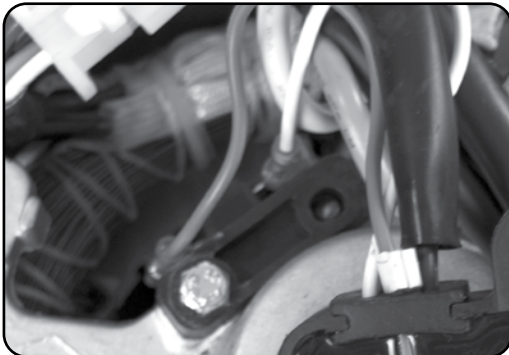

### 6. Reconnect wires to brush

Reconnect the wire clip.



### 7. Reconnect the AVR wire clip

Insert and connect the 2 wires from the AVR, be sure to connect + and - correctly.



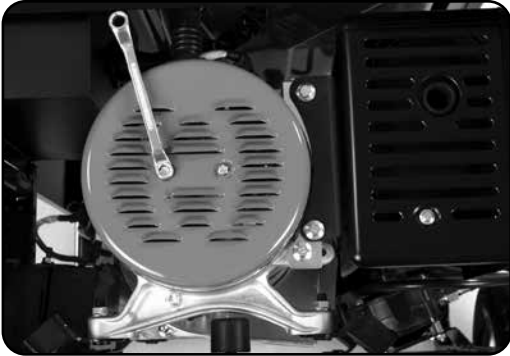

## 8. Replace generator cover

Replace the back cover of the generator and secure with the 2 bolts.

# WIRING DIAGRAM

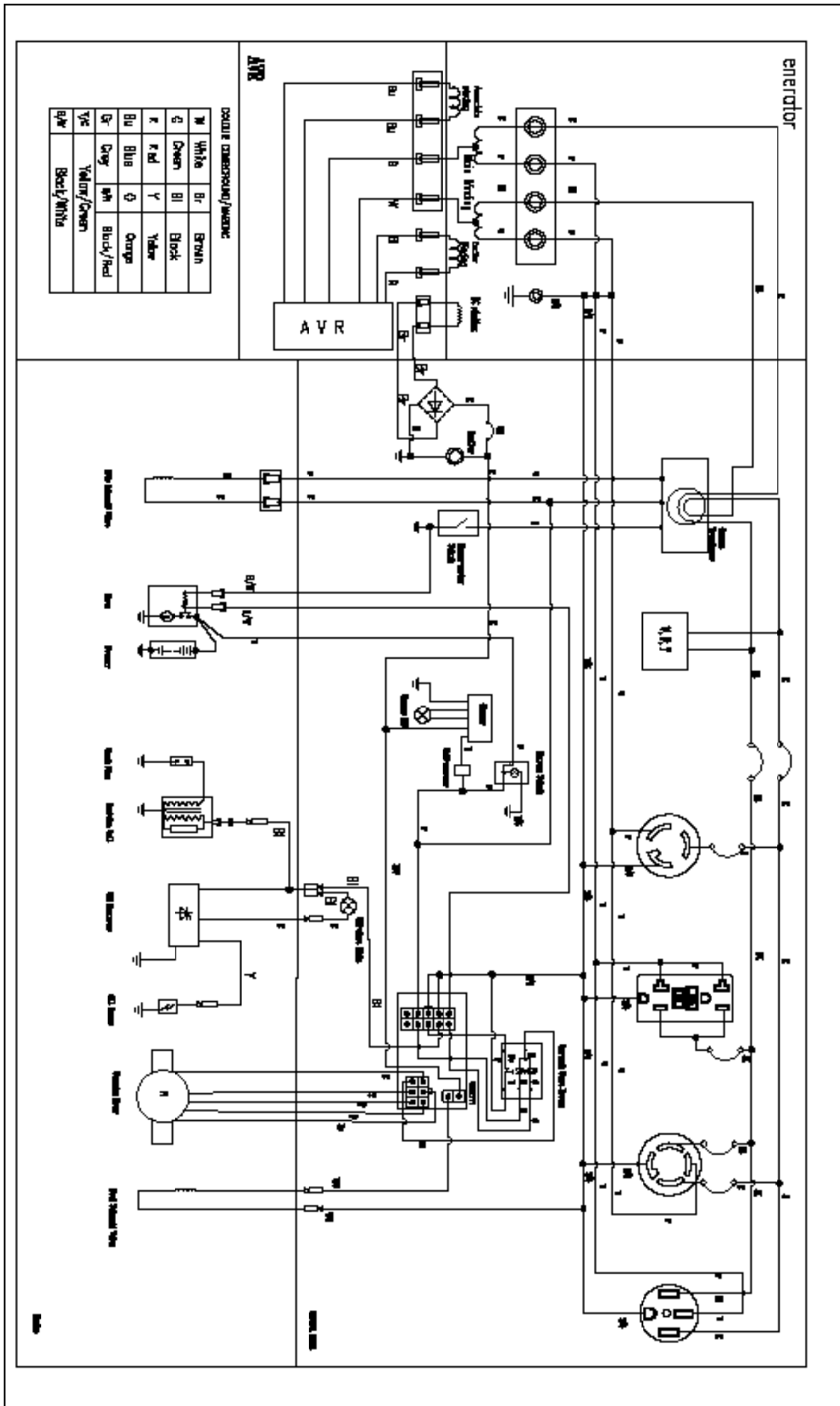



# WARRANTY

## **3-year Warranty**

All DuroMax Power Equipment warrant the original purchasers to a 3-year Parts Warranty (Residential Use ONLY: Unusually heavy or commercial use is covered for a period of 1-year) in the event of failure due to defects in electrical or mechanical components. Freight on any items submitted for replacement or repair under the Warranty are the responsibility of the equipment owner. This warranty is non-transferable and only valid to the original purchaser.

## **Warranty Exclusions**

The DuroMax Power Equipment warranty does not cover repairs or returns when the fault is: Normal Wear and Tear, Installation Use or Maintenance Services, Cosmetic defects, Accessories, Failures due to acts of God or Natural Disasters, or problems related to/from aftermarket or non-OEM parts.

## **Warranty Limitations**

DuroMax Power Equipment does not claim or hold any obligation to loss of time, freight charges, use of product, or any incidental damages from the use of this product. THIS WARRANTY IS IN LIEU OF ALL OTHER WARRANTIES, EXPRESSED OR IMPLIED.

## **U.S. EPA AND CALIFORNIA EMISSIONS CONTROL WARRANTY STATEMENT YOUR WARRANTY RIGHTS AND OBLIGATIONS**

The U.S. Environmental Protection Agency (EPA), California Air Resources Board, and Imperial Industrial Supply Co. LTD. / DuroMax Power Equipment are pleased to explain the emissions control system's warranty on your 2019/2020 small off-road engine. In California, new equipment that use small off-road engines must be designed, built, and equipped to meet the State's stringent anti-smog standards. DuroMax Power Equipment must warrant the emissions control system on your small off-road engine for the period listed below provided there has been no abuse, neglect, or improper maintenance of your equipment.

Your emissions control system may include parts such as: carburetors or the fuel injection system, ignition system, catalytic converters, fuel tanks, valves, filters, clamps, connectors, and other associated components. Also, included may be hoses, belts, connectors, sensors, and other emission-related assemblies.

Where a warrantable condition exists, DuroMax Power Equipment will repair your small off-road engine at no cost to you including diagnosis, parts, and labor.

## **MANUFACTURER'S WARRANTY COVERAGE:**

This emissions control system is warranted for two years. If any emissions-related part on your equipment is defective, the part will be repaired or replaced by DuroMax Power Equipment.

## **OWNER'S WARRANTY RESPONSIBILITIES:**

- As the small off-road engine owner, you are responsible for performance of the required maintenance listed in your owner's manual. DuroMax Power Equipment recommends that you retain all receipts covering maintenance on your small off-road engine, but DuroMax Power Equipment cannot deny warranty solely for the lack of receipts or your failure to ensure the performance of all scheduled maintenance.
- As the small off-road engine owner, you should however be aware that the DuroMax Power Equipment may deny you warranty coverage if your small off-road engine or a part has failed due to abuse, neglect, or improper maintenance or unapproved modifications.
- You are responsible for presenting your small off-road engine to a DuroMax Power Equipment distribution center or service center as soon as the problem exists. The warranty repairs should be completed in a reasonable amount of time, not to exceed 30 days.
- If you have any questions regarding your warranty coverage, contact us at 844-DUROMAX or email [support@duromaxpower.com](mailto:support@duromaxpower.com).

## **DEFECTS WARRANTY REQUIREMENTS:**

The warranty period begins on the date the engine or equipment is delivered to an ultimate purchaser and extends for a period of Two Years.

## **GENERAL EMISSIONS WARRANTY COVERAGE:**

DuroMax Power Equipment warrants to the ultimate purchaser and each subsequent owner that the engine or equipment is:

1. Designed, built, and equipped to conform with all applicable regulations adopted by the Air Resources Board; and
2. Free from defects in materials and workmanship that causes the failure of a warranted part for a period of two years.

The warranty on emissions-related parts will be interpreted as follows:

1. Any warranted part that is not scheduled for replacement as required maintenance in the Owner's Manual must be warranted for the warranty period stated above. If any such part fails during the period of warranty coverage, it must be repaired or replaced by the manufacturer according to Subsection (4) below. Any such part repaired or replaced under the warranty must be warranted for the remaining warranty period.

# WARRANTY (CONTINUED)

1. Any warranted part that is scheduled only for regular inspection in the Owner's Manual must be warranted for the warranty period stated above. A statement in such written instructions to the effect of "repair or replace as necessary" will not reduce the period of warranty coverage. Any such part repaired or replaced under warranty must be warranted for the remaining warranty period.
2. Any warranted part that is scheduled for replacement as required maintenance in the Owner's Manual must be warranted for the period prior to the first scheduled replacement point for that part. If the part fails prior to the first scheduled replacement, the part must be repaired or replaced by the engine manufacturer according to Subsection (4) below. Any such part repaired or replaced under warranty must be warranted for the remainder of the period prior to the first scheduled replacement point for the part.
3. Repair or replacement of any warranted part under the warranty must be performed at no charge to the owner at a warranty station.
4. Notwithstanding the provisions of Subsection (4) above, warranty services or repairs must be provided at all manufacturer distribution centers that are franchised to service the subject engines.
5. The owner must not be charged for diagnostic labor that leads to the determination that a warranted part is in fact defective, provided that such diagnostic work is performed at a warranty station.
6. The manufacturer is liable for damages to other engine components proximately caused by a failure under warranty of any warranted part.
7. Throughout the emissions warranty period stated above, the manufacturer must maintain a supply of warranted parts sufficient to meet the expected demand for such parts.
8. Any replacement part may be used in the performance of any warranty maintenance or repairs and must be provided without charge to the owner.
  - a. Such use will not reduce the warranty obligations of the manufacturer.
9. Add-on or modified parts that are not exempted by the Air Resources Board may not be used. The use of any nonexempt add-on or modified parts will be grounds for disallowing a warranty claim. The manufacturer will not be liable to warrant failures of warranted parts caused using a nonexempt add-on or modified part.
10. The manufacturer issuing the warranty shall provide any documents that describe that manufacturer's warranty procedures or policies within five working days of request by the Air Resources Board.

## Exhaust Emission Warranty Parts List.

1. Fuel Metering System
  - i. Carburetor and internal parts (and/or pressure regulator or fuel injection system).
  - ii. Air/fuel ratio feedback and control system.
  - iii. Cold start enrichment system.
2. Air Induction System
  - i. Controlled hot air intake system.
  - ii. Intake manifold.
3. Ignition System
  - i. Spark Plugs.
  - ii. Magneto or electronic ignition system.
  - iii. Spark advance/retard system.
4. Air Injection System
  - i. Air pump or pulse valve.
  - ii. Valves affecting distribution of flow.
  - iii. Distribution manifold.
5. Catalyst or Thermal Reactor System (i) Catalytic converter.
  - i. Thermal reactor.
  - ii. Exhaust manifold.
6. Particulate Controls
7. Traps, filters, precipitators, and any other device used to capture particulate emissions.
8. Electronic controls.
9. Vacuum, temperature, and time sensitive valves and switches.

## 10. Hoses, belts, connectors, and assemblies.

11. Evaporative Emission Warranty Part List
  - i. Fuel Tank\*
  - ii. Fuel Cap
  - iii. Fuel Line
  - iv. Fuel Line Fittings
  - v. Clamps\*\*
  - vi. Pressure Relief Valves\*\*
  - vii. Control Valves\*\*
  - viii. Control Solenoids\*\*
  - ix. Electronic Controls\*\*
  - x. Vacuum Control Diaphragms\*\*
  - xi. Control Cables\*\*
  - xii. Control Linkages\*\*
  - xiii. Purge Valves
  - xiv. Vapor Hoses
  - xv. Liquid/Vapor Separator
  - xvi. Carbon Canister
  - xvii. Canister Mounting Brackets
  - xviii. Carburetor Purge Port Connector

\*Note: The parts list for equipment less than or equal to 80 cc only includes the fuel tank.

\*\*Note: As they relate to the evaporative emission control system.

DuroMax Power Equipment will furnish with each new engine written instructions for the maintenance and use of the engine by the owner.

# CUSTOMER SERVICE

Duromax Power Equipment is committed to ensuring that our products perform when they need to. Our generators are your lifeline in the event of an emergency. Should you have any problems, please contact our customer service department:

**DUROMAX POWER EQUIPMENT**  
**5800 Ontario Mills Parkway**  
**Ontario, CA 91764**

Customer Service: 844-DUROMAX  
Customer Service Hours: 8-5pm PST

Website: [www.duromaxpower.com](http://www.duromaxpower.com)  
Email: [customer\\_service@duromaxpower.com](mailto:customer_service@duromaxpower.com)









5800 Ontario Mills Parkway  
Ontario, CA 91764  
United States

844-DUROMAX