

ASAKUKI

3-IN-1 Ultrasonic Humidifier Diffuser - Night Light

User Manual

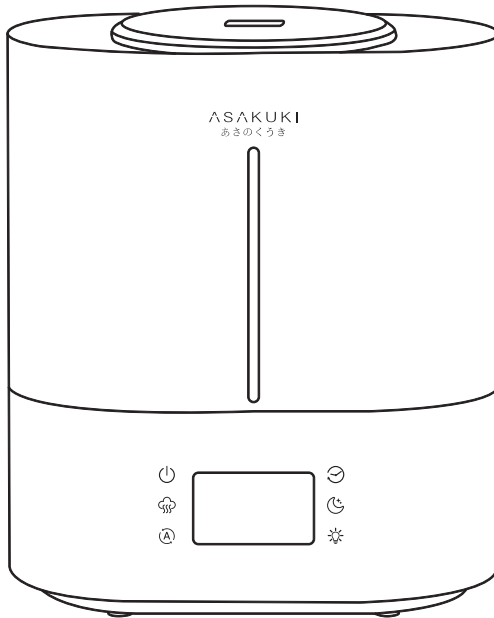

Product Series: FALL

Need Help?
Please contact us at support@asakuki.com

Model: ZH-001S

TABLE OF CONTENTS

PACKAGE CONTENTS	01
SPECIFICATIONS	02
SAFETY INFORMATION	03
GETTING TO KNOW YOUR HUMIDIFIER	04
• Humidifier Diagram	04
• Control Panel	05
• Display	06
• Remote Control	07
GETTING STARTED	08
• Filling and Refilling	10
• Using the Aroma Box	11
OPERATING YOUR HUMIDIFIER	13
• Turn On the Humidifier	13
• Auto Mode	13
• Custom Mode	14
• Intelligent Sleep Mode	14
• Humidity Comfort Indicator	14
• Timer Setting	14
• Night Light	15
• Turning Off the Display	15
• Memory Function	15
• Automatic Shut Off	15
CARE & MAINTENANCE	16
• Cleaning	16
TROUBLESHOOTING	18
WARRANTY	20

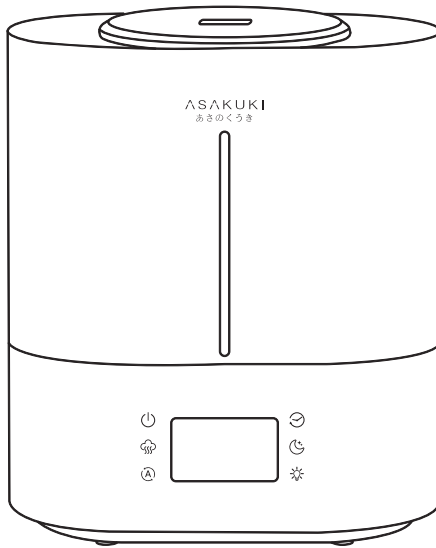

- Demineralization filters
- Use with ASAKUKI scented pad
- Whisper quiet
- Sleep friendly
- Automatic humidity control
- Auto shut off

ZH-001S Series Accessories

The following optional accessories work great with your humidifier.

• ASAKUKI Scented Pad(One lavender sample included)

Use ASAKUKI scented pad with your humidifier for soothing vapors.

Enjoy up to 1 month of soothing comfort per pad.



• ASAKUKI Demineralization Cleaning Filter (One included)

This humidifier features a demineralization filter, that helps to reduce white dust and keep your humidifier cleaner, longer.

Contains no harmful chemicals.

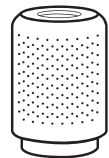

PACKAGE CONTENTS

- 1 × 4L Ultrasonic Cool Mist Humidifier
- 1 x Humidifier Cleaning Filter
- 1 x Remote Control
- 5 x Aroma Pads
- 1 x Scented Pad(Lavender)
- 1 x Cleaning Brush
- 1 x User Manual
- 1 x Quick Start Guide

SPECIFICATIONS

Model No.	ZH-001S
Rated Voltage	AC 100V-240V, 50/60Hz
Power	27W
Rated Mist Output	200 mL/H
Capacity	4L/1.05gal
Noise Level	≤ 35dB(A)
Suitable Area	Bedroom/Living/Large Room
Product Size	150*250*293 mm/5.9*9.8*11.5 in
Net Weight	1.19KG/2.62lbs

SAFETY INFORMATION

To reduce the risk of fire, electric shock, or other injury, when using your humidifiers, basic safety precautions should always be followed. Read all instructions before using.

- When not in use, turn the humidifier off and disconnect from power source by removing the plug from the outlet.
- Place the humidifier on a dry, flat, stable surface. **Do not** place the humidifier directly on carpets or rugs.
- Place the humidifier and cord so that the humidifier will not be knocked over.
- **Do not** place the humidifier on or near heat sources such as radiators, heated ovens, etc.
- Close supervision is necessary when the humidifier is used by or near children
- **Do not** overfill the water tank. Water should not exceed the MAX level.
- **Only** fill the tank with cold pure water (distilled/purified water). Never fill the humidifier with other liquids.
- **Do not** add essential oils or other objects into the water tank or base chamber.
- **Do not** cover the nozzle while the humidifier is on.
- **Do not** attempt to inhale the mist directly from the nozzle.
- **Do not** immerse the cord, plug or base in water or other liquids.
- **Do not** use the humidifier for other than intended purpose.
- **Do not** use the humidifier if it is malfunctioning, or if any part, including the base, water tank, cord, or plug, is damaged in any way. Stop using it and Contact Customer Support immediately.
- Keep the humidifier out of reach from children.

**SAVE THESE INSTRUCTIONS
FOR HOUSEHOLD USE ONLY**

GETTING TO KNOW YOUR HUMIDIFIER

Humidifier Diagram

- | | | |
|-------------------------------|------------------------|---------------------------|
| A. Mist Out | G. Water Level | M. Aroma Box |
| B. Lid | H. Touch Button | N. Humidity Sensor |
| C. Mist Tube | I. LED Display | O. Feet |
| D. Cleaning Filter | J. Air Inlet | P. Power Cord |
| E. Remote Control | K. Water Tank | |
| F. Discharging Opening | L. Aroma Pad | |

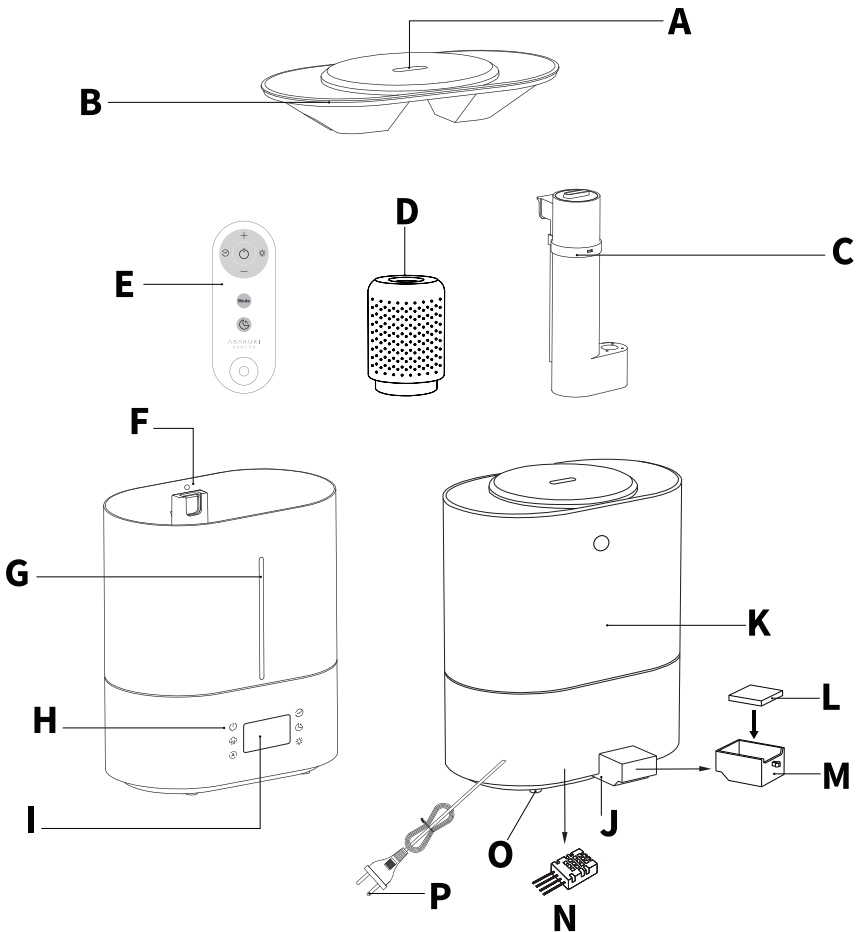

GETTING TO KNOW YOUR HUMIDIFIER

Control Panel

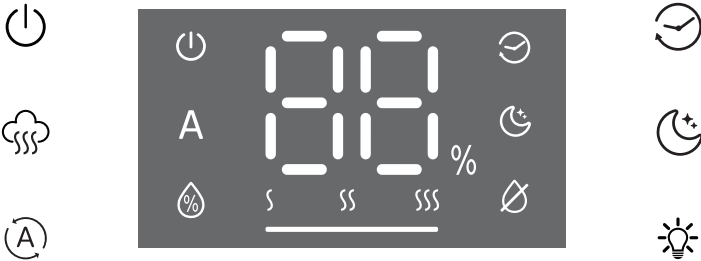

Power Button

- Press to turn the humidifier on/off.

Mist Level Button

- Press repeatedly to cycle through mist level settings: low, medium and high mist. The default mist level is low.



Auto/Custom Mode Button

- Press once to turn Auto Mode on. The default target humidity level is 60%.
- Press again to customize your target humidity.
- Press repeatedly to choose a target relative humidity between 40% and 80% (with 5% increments per adjustment).
- Press  to exit the Auto Mode.

Timer Button

- Press to choose a time setting between 1h and 12h.

Sleep Mode Button

- Press to turn Sleep Mode on/off.
- Press  or  to exit the Sleep Mode.

Night Light Button

- Press to turn the night light on/off.
- Press and hold for 5 seconds to turn the display off.
- Press any button to wake the display.

GETTING TO KNOW YOUR HUMIDIFIER

Display

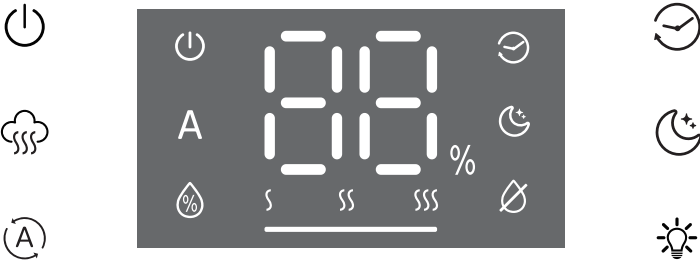

A Auto Mode Indicator

 Humidity Setting Indicator

 Humidity Percentage (RH)

 Timer Indicator

 Sleep Mode Indicator

 No Water Indicator

 Low Mist Indicator

 Medium Mist Indicator

 High Mist Indicator

 Comfort Indicator

GETTING TO KNOW YOUR HUMIDIFIER

Remote Control

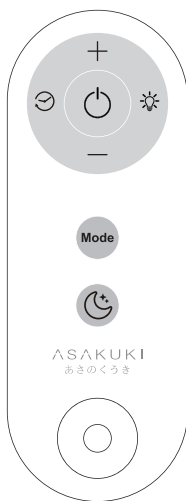

Button	Icon	Function
Power		Press to turn the humidifier on/off
Mist Level	+ -	At mist level setting, choose to set mist level settings: low, medium and high mist level At humidity setting, choose a target relative humidity between 40% and 80% (with 5% increments per adjustment)
Mode	Mode	1st Press: Turn auto mode on, A will appear on display 2nd Press: Switch to humidity setting mode, % will appear on display 3rd Press: Switch to choose mist level setting, S/SS/SSS will appear on display
Sleep Mode		Press once to turn Sleep Mode on/off
Timer		Press to choose a time setting between 1h and 12h
Night Light		Press to turn the night light on/off

GETTING STARTED

1. Remove all packaging.
2. Clean the water tank and top cover before first use.
3. Make sure the mist tube is correctly placed. *[Figure 1.1]*



4. Take out the filter and remove the packaging, pre-soak for 15 minutes in a separate container before first use. (See filter instruction)
5. Rotate the filter to the water tank to secure it in place. *[Figure 1.2]*

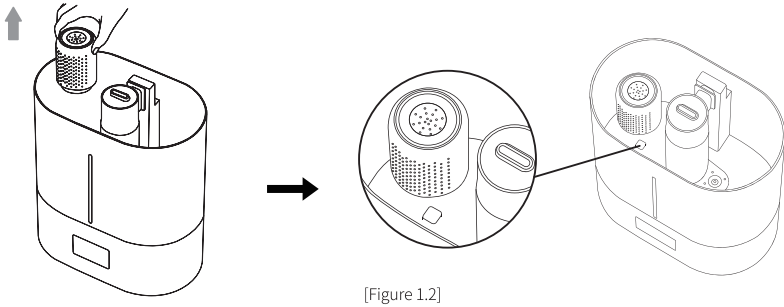

6. Choose a flat, hard location for the humidifier at least 12 inches/30 cm away from any walls. The surface must be water-resistant. *[Figure 1.3]* Placing the humidifier on the ground directly may cause bad performance. It is recommended to put it on a smooth countertop or table instead.

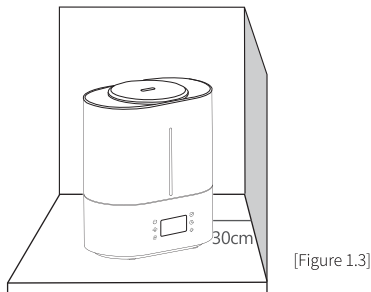

GETTING STARTED

7. Mist should be directed away from any walls, furniture, bedding and appliances.
[Figure 1.4] Avoid letting too much mist fall on the side of the humidifier with the aroma box, as this may interfere with the sensor.

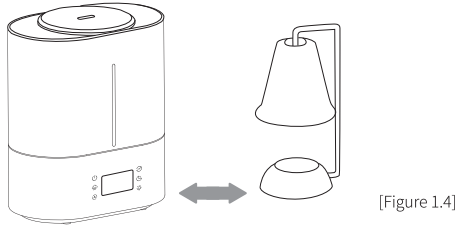

⚠ Note:
DO NOT place the humidifier on towels, carpets, rugs, or any surfaces with fibers.
This may block the air inlet at the bottom of the humidifier and cause malfunctioning. [Figure 1.5]

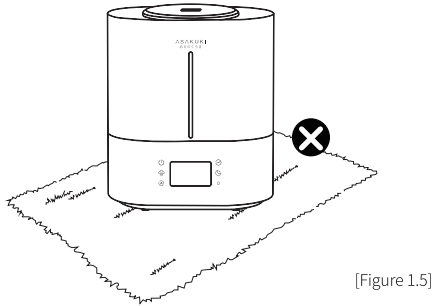

GETTING STARTED

Filling and Refilling

1. Take out the top cover by holding the lid and pulling it upward, or add water from the lid's sides. [Figure 2.1]

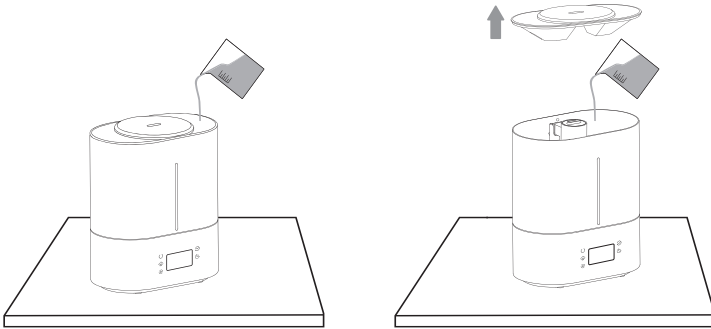

[Figure 2.1]

2. Fill the tank with cold water. We recommend using purified water. Avoid using tap water. Minerals in tap water will create white dust around the humidifier.
3. Wipe off any excess water on the tank and base.

⚠ Note:

- **Do not** fill with hot water or other liquids.
- **Do not** fill water beyond the max water line.
- **Do not** add water through the mist tube.
- **Do not** add essential oils to the water tank. Drip essential oil on the aroma pad **only**.

[Figure 2.2]

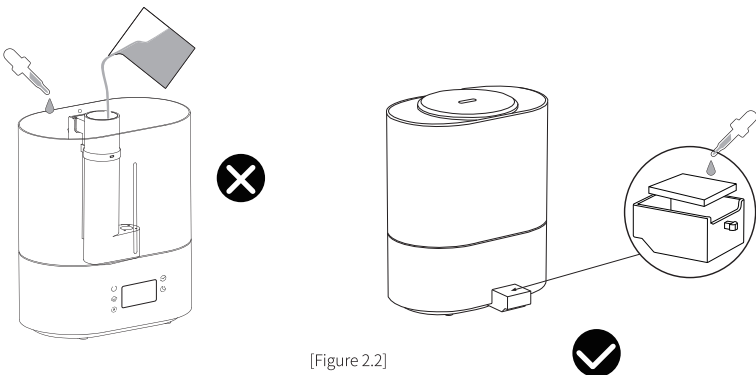

[Figure 2.2]

GETTING STARTED

Using the Aroma Box

Your humidifier can be used for aromatherapy.

Using ASAKUKI Scented Pad

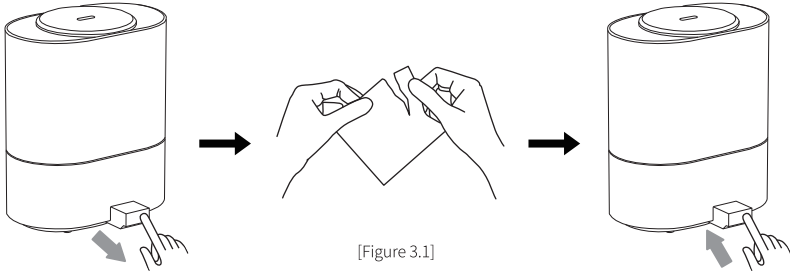

Your humidifier can be used with ASAKUKI Scented Pad to provide up to 1 month of soothing vapors. One free sample of the ASAKUKI lavender scented pad is included with your humidifier. To use your unit with ASAKUKI Scented Pad:

1. Gently push the aroma box on the back of the base and pull it out.
2. Open scented pad by tearing notch on pad bag. **DO NOT** touch scented pad with hands. If pad is touched, **DO NOT** touch face or eyes before washing your hands as it may cause irritation.
3. Insert the scented pad then replace the aroma box.
4. When the fragrance fades, discard the scented pad.

GETTING STARTED

Using Essential Oils

Your humidifier can be used for aromatherapy. Follow the below instructions to add essential oil.

1. Gently push the aroma box on the back of the base and pull it out.
2. Add 10-15 drops of essential oil to the aroma pad.
3. Replace the aroma box into the humidifier.
4. Turn on the humidifier and it will automatically diffuse aroma when used.

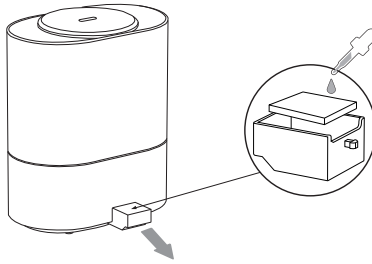

[Figure 3.2]



⚠ Note:

- For best results, we recommend using pure essential oil.
- The aroma pads can be cleaned and reused after diffusing essential oils.
- The aroma is intended to be light.

OPERATING YOUR HUMIDIFIER

Turn On the Humidifier

Please fill the tank before turning on the humidifier. If there is no water in the tank, no water indicator  will appear on the display, and the humidifier will automatically turn off.

1. Plug in the humidifier. All indicators will light on for 1.5 seconds, then turn off.
2. Press  to turn your humidifier on. The humidifier will start misting on the low mist level.
3. Press  repeatedly to cycle through mist settings: Low, Medium, and High.
4. Optionally, you can choose Auto Mode, Humidity Setting Mode, Sleep Mode, Timer, Night light or turn off the display. Please see the detailed instructions on the following pages.

Auto Mode

Auto Mode uses the humidifier's sensor to automatically adjust the mist level to maintain a human comfortable and healthy humidity level.

1. Press  to turn Auto Mode on. Indicator **A** will appear on the display. The humidifier automatically produces mist based on the room humidity level.
2. Auto Mode means the humidifier will automatically stop misting when the highest target humidity reached the default level(60%).
3. When the humidity drops to 5% below the target RH percentage, it will start misting again.
4. The humidifier will continue detecting the humidity level in the room. It will start and stop misting again according to the following table:

Room Relative Humidity	Automatic Mist Level
Under 40%	High
40% ~ 50%	Medium
50% ~ 60%	Low
Over 60%	Automatic Stop



Note:

Changing the mist level while in Auto Mode will exit the Auto Mode.

OPERATING YOUR HUMIDIFIER

Custom Mode

Custom Mode allows customers to set a target humidity between 40% and 80% (with 5% increments per adjustment).







1. Press  twice to turn Custom Mode on. Indicator  will appear on the display.
2. Press repeatedly to choose an RH percentage between 40% and 80%(with 5% increments per adjustment).
3. Once an RH percentage is selected, the humidity percentage indicator will flash 5 times to confirm. When the humidity percentage of the environment reaches the target RH percentage, it will automatically stop misting.
4. When the humidity drops to 5% below the target RH percentage, it will start misting again.

Note:

Changing the mist level while in Custom Mode will exit the Custom Mode.

Intelligent Sleep Mode

Sleep Mode uses a humidity sensor to automatically adjust the mist level to maintain a 40%-60% relative humidity. The display will be off and make it ideal for sleep.

1. Press  to turn Sleep Mode on/off. Indicator  will appear on the display.
2. When Sleep Mode is on, you can press any button to wake up the display. If you stop touching the display, the display will turn off again after 6 seconds.
3. Once you wake up the display, press  or  to exit the Sleep Mode and resume manual controls.
4. Optionally, press  to set a timer or press  to turn on/off the night light if needed.





Humidity Comfort Indicator

The humidifier features an indicator light to indicate DRY/COMFORT/WET air conditions, quickly informs you how to adjust your humidifier to optimal comfort.

Room Relative Humidity	Indicator Light Color	Humidity Comfort
Under 30%	Red	Dry
30% ~ 60%	Green	Comfort
Over 60%	Blue	Wet

OPERATING YOUR HUMIDIFIER

Timer Setting

1. Press  repeatedly to choose a time setting between 1 hour to 12 hours.
2. Once a time was set, the timer will start. Indicator  will appear on the display.
3. Press  to know the remaining time.
4. The humidifier will automatically power off once the timer is over.
5. Press  to 0 to close the timing.

Night Light

1. The humidifier features a night light. You can press  to turn it on/off.

Turning Off the Display

1. To turn off the display, press and hold  for 5 seconds.
2. Press any button to wake up the display.

Memory Function

1. The humidifier will remember Custom Mode settings, and the display will automatically turn back on when the humidifier is turned back on.

Automatic Shut Off

1. The humidifier will automatically shut off when all of the water in the tank runs out.
 will show on the display and you will hear three beeps..

CARE & MAINTENANCE

⚠ Note:

1. All maintenance should be done on a water-resistant surface near a faucet, such as a kitchen counter.
2. Change the water daily to avoid bacteria growth.
3. **Do not** wash any components of this humidifier in the dishwasher.
4. If not using the humidifier for 1 week or longer, **do not** leave water inside. Clean the humidifier and keep it dry.
5. **Do not** let water into air outlet in the water tank as it may damage the inner parts, make sure the mist pipe is completely dry until you resin it.

Cleaning

You should clean your humidifier water tank every 3 days.

1. Unplug the humidifier. *[Figure 4.1]*

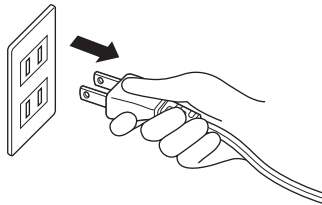

[Figure 4.1]

2. Remove the top cover, mist tube, aroma box from the humidifier. Empty water from the water tank.
3. Add 3 US cups / 710 ml of distilled white vinegar to the water tank and soak for 15-20 minutes. *[Figure 4.2]*

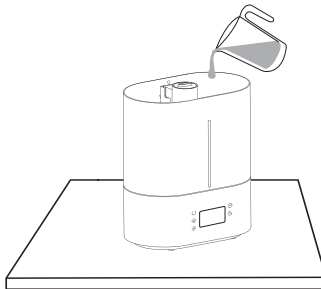

[Figure 4.2]

CARE & MAINTENANCE

4. Pour out any vinegar solution. Use a soft cloth and the cleaning brush to clean.
5. Rinse the top cover, place the mist tube, aroma box in a small container. Fill with enough water with vinegar to cover them. Soak for 15-20 minutes. Use a soft cloth and the included cleaning brush to remove scale from all parts [Figure 4.3]

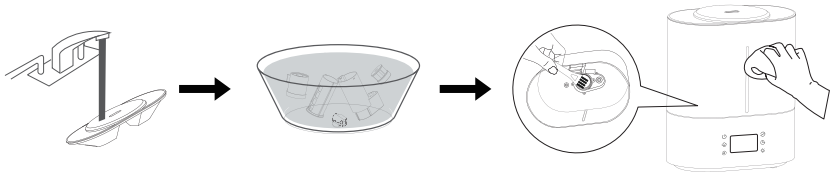

[Figure 4.3]

6. Rinse all parts until any vinegar smell is completely gone. Make sure all parts are completely dry before reassembling or storing.

Storing

Follow the cleaning instructions and allow all parts to dry completely before storing. Store in a cool dry place.

TROUBLESHOOTING

Room Relative Humidity	Possible Solution
Humidifier doesn't turn on.	<ul style="list-style-type: none"> ● Make sure the plug is securely inserted into the outlet. ● Insert the plug into a different outlet for checking.
Little or no mist comes out.	<ul style="list-style-type: none"> ● Turn the mist level to a higher setting. ● Clean the humidifier. Make sure the nozzles are not blocked or clogged. ● Make sure the humidifier is on a level surface. ● If the water tank was washed with detergent, rinse thoroughly with clean water to remove any detergent. ● The water temperature may be too low. Turn on the humidifier and let it run for a while, then adjust to the desired setting. ● In Auto/Sleep/Custom Mode, when the humidity percentage of the environment reaches your target RH percentage, it will automatically stop misting.
Humidifier uses water too quickly.	<ul style="list-style-type: none"> ● The humidifier uses up water based on the environmental temperature and humidity. If your environment is cold and/or dry, the humidifier will run out of water faster.
Humidifier produces an unusual smell.	<ul style="list-style-type: none"> ● If the humidifier is new, unplug and rinse all parts, then place in a cool, dry place for 12 hours. ● If essential oils were placed on the aroma pad, rinse the pad under clean water and allow it to dry. ● Clean the humidifier.
Humidifier makes a loud or unusual noise.	<ul style="list-style-type: none"> ● Make sure the mist tube is properly in place. ● Set the mist level to a lower setting. ● Empty the water tank. Refill the water tank and make sure to place the humidifier on a flat, level surface.
Water leaks from the humidifier.	<ul style="list-style-type: none"> ● Make sure to place the humidifier on a flat, level surface. ● Make sure the mist tube is properly in place. ● Avoid running the humidifier in a room with over 65% relative humidity. ● Do not shake the humidifier. ● Check the water tank for leaks. If there are leaks, contact Customer Support. ● If water leaks from the aroma box, please make sure the mist pipe was taken out before pouring out the water.

TROUBLESHOOTING

Room Relative Humidity	Possible Solution
White dust appears around the humidifier.	<ul style="list-style-type: none"> ● We recommend using purified or distilled water to fill the humidifier. Avoid using tap water or other water with high mineral content. ● Clean the humidifier and the filter.
The area around the humidifier is damp or wet from condensation.	<ul style="list-style-type: none"> ● Humidity may be too high. Turn down the mist or turn off the humidifier, and open a door or window. ● Open a window to ensure proper airflow for the humidifier, or move the humidifier to a more well-ventilated room.
Mold grows inside the humidifier.	<ul style="list-style-type: none"> ● Clean the water tank and accessories regularly.
🔴 lights up red	<ul style="list-style-type: none"> ● Fill the water tank.
Scented pad has little or no smell.	<ul style="list-style-type: none"> ● Exchange a new one. ● If there are questions, contact Customer Support.
Display shows an incorrect humidity percentage.	<ul style="list-style-type: none"> ● The room may be larger than the humidifier's effective range. Move to a room smaller than 430-645 ft² / 40-60 m². ● Moisture may have built up inside the humidity sensor. Turn off the humidifier, remove the aroma box, and allow the sensor to air dry. ● If the humidifier is placed within 6 inches / 15 cm of a wall or in a corner, the humidity sensor cannot provide a proper reading for the relative humidity in the room. ● The humidity sensor will give an improper reading if it is exposed to dust. Avoid using the humidifier in dusty rooms. Avoid using tap water in the humidifier as this can increase dust in the air.
The humidity level isn't changing in my room.	<ul style="list-style-type: none"> ● Use a higher mist level setting. ● Depending on your environment, the humidifier may take longer to humidify your air. ● The room may be larger than the humidifier's effective range. If the room is larger than 430-645 ft² / 40-60 m², the humidifier will not be as effective.

**Have any other questions?
Please immediately contact Customer Support!**

WARRANTY

The One-Year Limited Warranty is valid for products purchased from our ASAKUKI only, starting from the date of original retail purchase against defects in quality and materials under normal, non-commercial use. According to the requirements outlined in this instruction manual, subject to the following conditions and exclusions. This warranty does not cover the other accessories (if included) except for material or workmanship defects.

What Is Covered

The repair or replacement of your ASAKUKI appliance if your ASAKUKI appliance is found to be defective due to faulty materials, workmanship or function within one year of purchase or delivery [if any part is no longer available or out of manufacture, ASAKUKI will replace it with a functional replacement part]. This warranty provides, at no extra cost to you, all labor and parts necessary to ensure your machine is in proper operating condition during the warranty period.

What Is Not Covered

Under your ASAKUKI guarantee, ASAKUKI shall not be liable for costs of repair or replacement of a product incurred as a result of: Accidental damage, faults caused by negligent use or care, misuse, neglect, careless operation or handling of the ASAKUKI appliance which is not in accordance with this ASAKUKI Operating Manual. Machines purchased from an unauthorized dealer. Use of parts and accessories other than those produced or recommended by ASAKUKI. Repairs or alterations carried out by unauthorized parties or agents. Use of the machine other than for normal domestic purposes within the United States, e.g. for commercial or rental purposes.

Extend Warranty

If you have a query about your ASAKUKI appliance, please contact the ASAKUKI customer service email: **support@asakuki.com**

Register your product within 60 days of purchase to extend your 1-year warranty by an additional year. Register your product at <https://asakuki.com/pages/warranty>. Please inform us of your model name/number, purchase date, order number, machine problem and your requirement. Your model number can be found on the rating plate. Please keep your purchase receipt in a safe place to ensure you have this information. Service under this warranty will not extend the period of this warranty.

If you have any questions about our products, please contact our customer support team.

Brand: ASAKUKI

Product Name: Humidifier

Model Number: ZH-001S

Power Supply: AC 100-240V, 50/60Hz

WEEE-Reg. -Nr: DE: DE 41980660 FR: FR031399 05UERI

Manufacture: Chongqing ChuangHong Dian Zi Shang Wu You Xian GongSi

Address: 1 zhuang 11-3, jin kai da dao 1228 hao, bei bu xin qu, Chongqing, 401120, China

Email: support@asakuki.com



UK Responsible Person: JunBright Ltd

Address: 51 Chalton Street London, England, NW1 1HY

Email: yldyx112@outlook.com



EU Responsible Person: C&E Connection E-Commerce (DE) GmbH

Address: Zum Linnegraben 20, 65933, Frankfurt am Main, Germany

Email: info@ce-connection.de



MADE IN CHINA



Q ASAKUKI-Direct



Q asakuki_official



Q ASAKUKI.com