

NOTES:

All Measurements in Inches
 Approx. Assembly Weight: 530.0 lbs.

Parts:	Qty:
--------	------

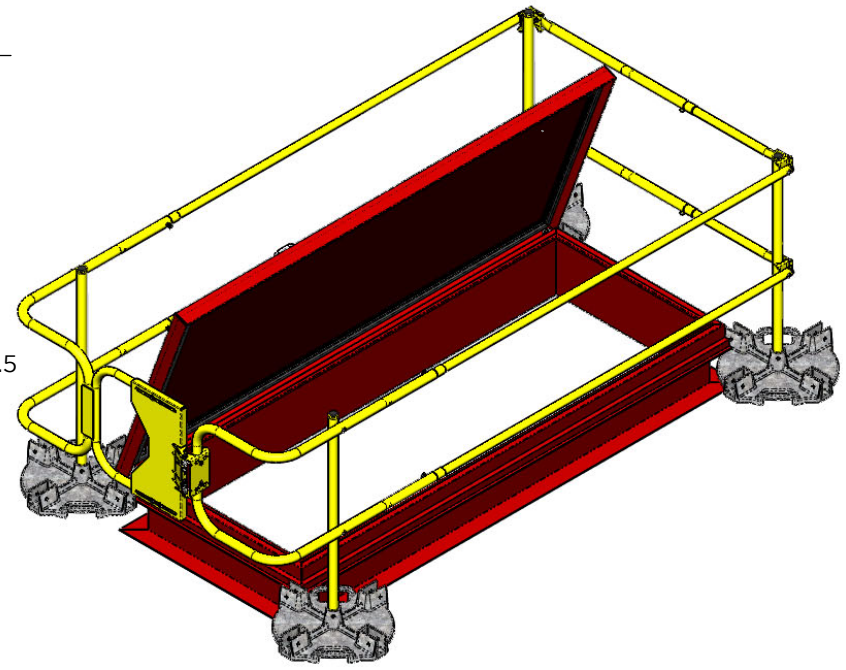
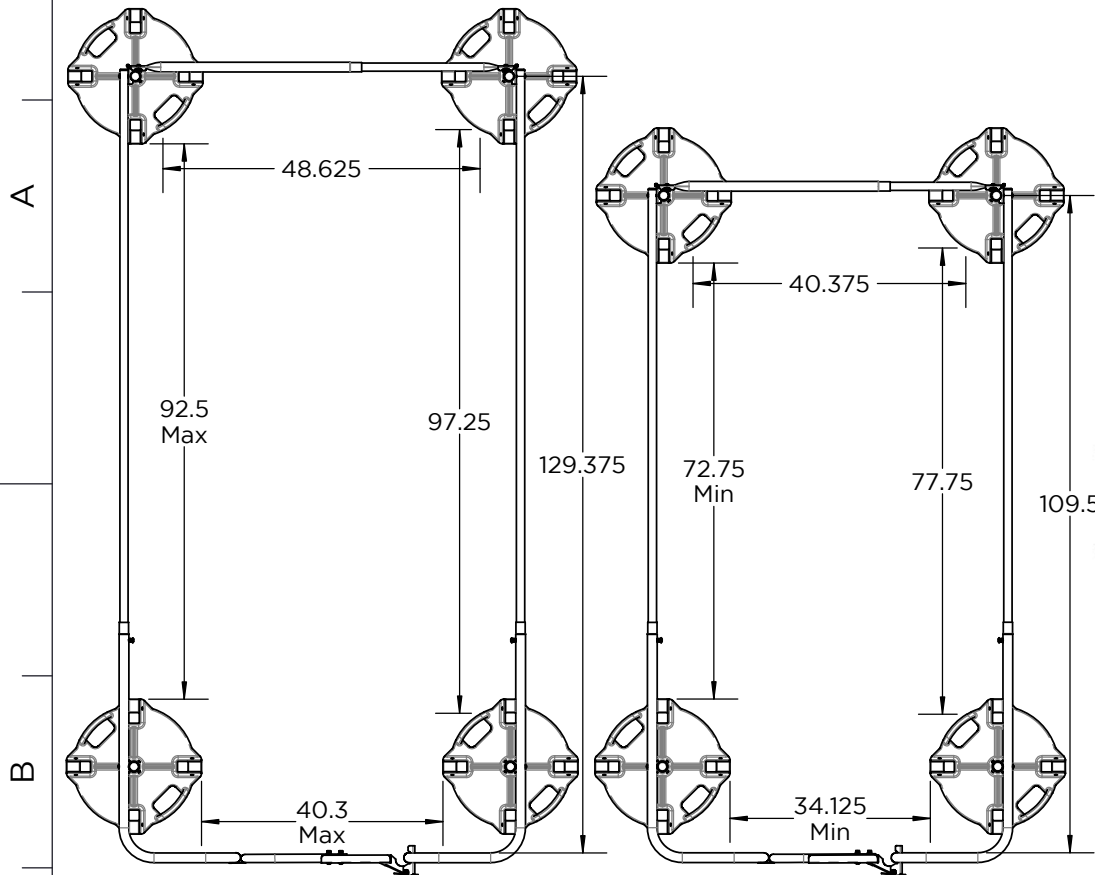

1345 TANEY STREET
 NORTH KANSAS CITY, MO 64116
 (T) 888-990-2990
 (P) 816-471-1349
 SALES@LEADINGEDGESAFETY.NET
 Information in this drawing is for reference only.

Scale: Varies (8.5x11)
 Dwg: WBRH-36x96-17

Ballasted Base Roof Hatch Guard
 Rail Assembly
 36" x 96" Inside Roof Hatch Unit