

1 2 3 4

NOTES:

All Measurements in Inches
Approx. Unit Weight: 160. lbs.

Parts:	Qty:

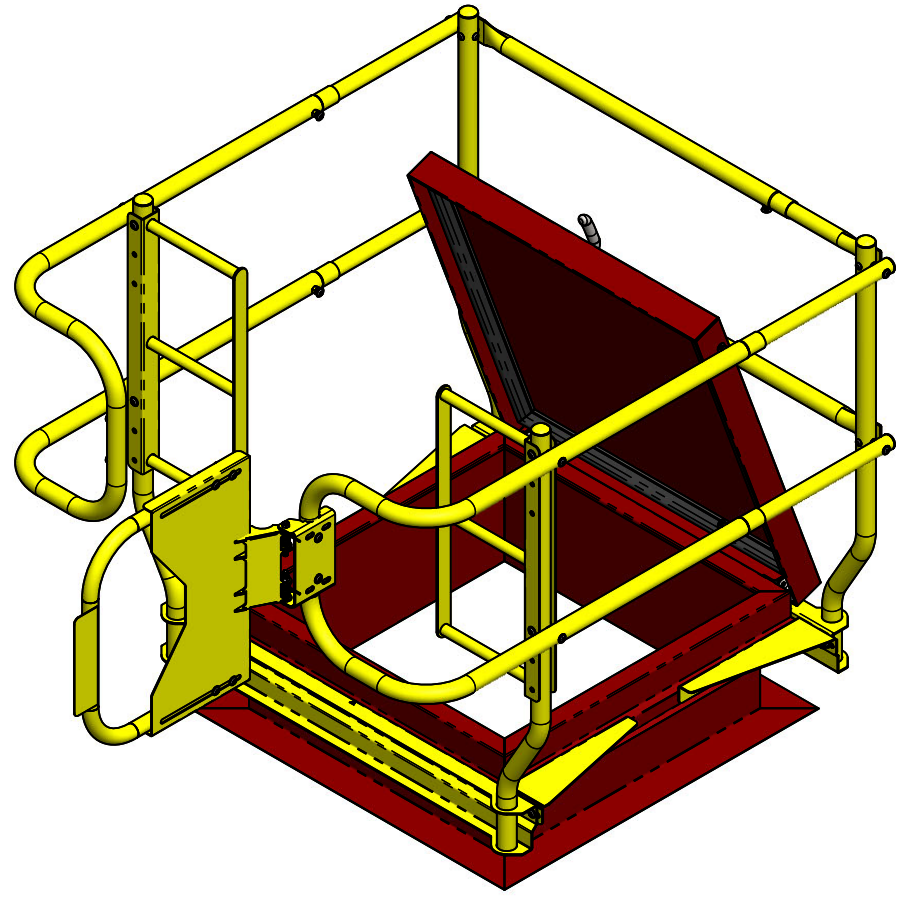
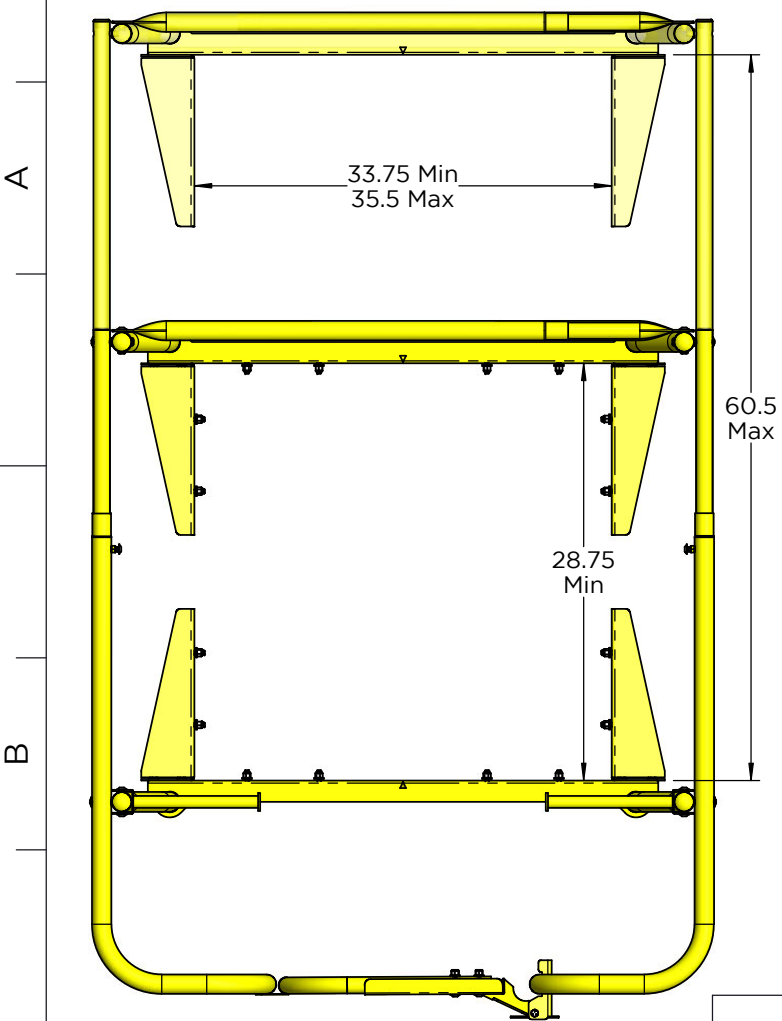

1345 TANEY STREET
 NORTH KANSAS CITY, MO 64116
 (T) 888-990-2990
 (P) 816-471-1349
 SALES@LEADINGEDGESAFETY.NET
 Information in this drawing is for reference only.

Scale: 1/16" - 1" (8.5x11)
 Dwg: PRS-RH-30X30(54)-15

Roof Hatch Rail System Assembly
 30" x 30"-54" Common Sized Unit

1 2 3 4