

Instruction Manual

RainPoint[®]
More Than Water Saving



WIFI AUTOMATIC WATERING PUMP KIT

Model: IK10PW

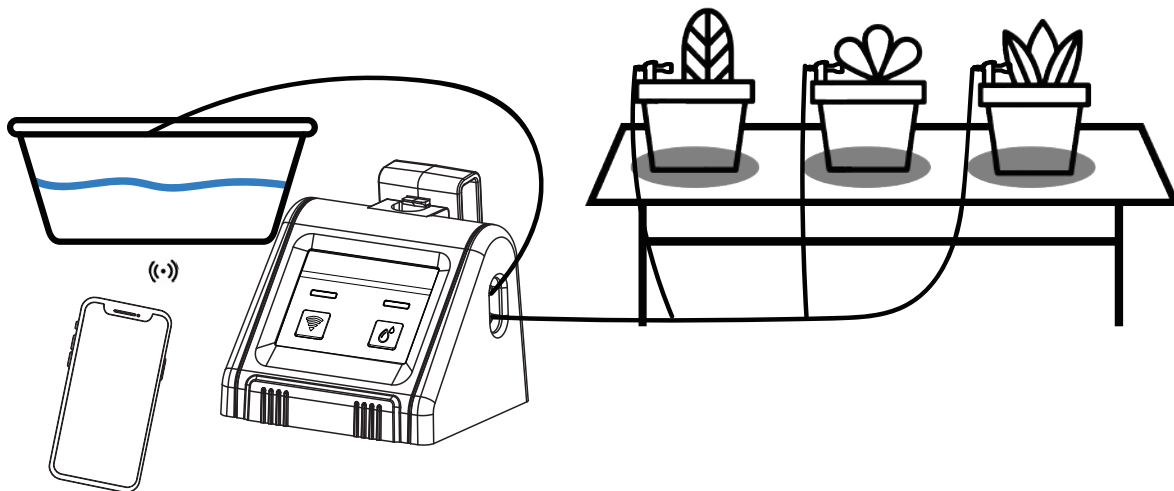

Free Hotline

US: +1 833-381-5659

(MON-FRI 9:30 AM-5:30 PM PST)

EU: +44 800-808-5337

(MON-FRI 9:00 AM-5:00 PM CET)

Customer Support

Web: www.rainpointonline.com

Email: service@rainpointus.com

WhatsApp: +1 626-780-5952

WELCOME TO RAINPOINT -----

Dear friend,

Thanks for choosing RAINPOINT WiFi automatic watering system!

Your satisfaction as a RAINPOINT customer means everything to us.

Before using this unit, please read these operating instructions carefully, take special care to follow the warning and safety suggestions. If you have any questions or problems during using our product, please contact our customer service and your problem will be solved within 24hrs. Contact on Amazon: Click on “ **Ask a question**”

 Web: www.rainpointonline.com

 Email: service@rainpointus.com

 WhatsApp: +1 626-780-5952

 US Free Hotline(English):

+1 833-381-5659(MON-FRI 9:30 AM-5:30 PM PST)

UK Free Hotline(English Deutsch):

+44 800-808-5337(MON-FRI 9:00 AM-5:00 PM CET)

TABLE OF CONTENTS

PRODUCT OVERVIEW	01-03
1. PRODUCT APPEARANCE	01
2. PACKAGE INCLUDES	02-03
3. SPECIFICATION	03
FCC NOTICE	04
SIMPLE TO PAIR WIFI	05-11
1. INITIAL RAINPOINT APP SETUP	05
2. PAIR THE WATER PUMP	06-11
EASY TO INSTALL	12-16
1. TWO POWER SUPPLY METHODS	12-13
<u>1.1 Install 4*AA 1.5V alkaline batteries for power</u>	12
<u>1.2 Plug in the USB cable for power</u>	13
2. DETERMINE THE CORRECT PLACEMENT	14
3. CONNECT THE HOSE CORRECTLY	15-16
4. INSTALLATION COMPLETED AND TESTED	16

APP INTERFACE OVERVIEW	17-22
1. HOME INTERFACE	17
2. IRRIGATION SCHEDULE SETTINGS	18
3. DEVICE INFORMATION	19
4. SMART FUNCTIONS INTERFACE	20-22
5. PERSONAL DATE INTERFACE	23
AUTOMATIC WATERING MODE	24
MANUAL WATERING MODE	25
RESET THE DEVICE	26
TROUBLESHOOTING	26-27
WARRANTY	28
CUSTOMER SUPPORT	28





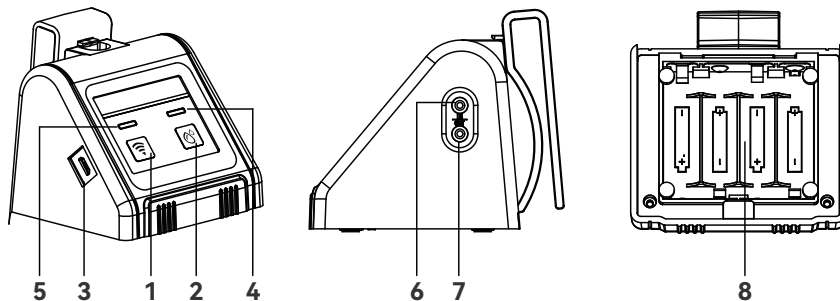

PRODUCT OVERVIEW



1. Product Appearance

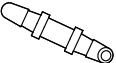

No.	Name	Function
1	WiFi Button	Pair WiFi or reset
2	Manual Button	Manual or pause watering
3	USB Port	Powering and wifi connection
4	Watering Indicator Light	Indicates the status of watering
5	Pair WiFi or power supply	Indicates the status of wifi connection
6	Inlet Port	Water conveying from container to pump
7	Outlet Port	Water conveying from pump to plants
8	Battery Compartment	Power supply

2. Package Includes

Accessories Included	Name	PCS	Function
	USB Cable	1	Pair WiFi or power supply
	Tubing	1	Len: 10m/32.8 Ft Inner diameter of pipe:0.17" (> 1/6") Outside diameter of pipe: 1/4"
	Filter	1	Filtering impurities from water
	Tubing End Caps	3	Stop water flow at the end of the pipe
	Micro Drip Emitters	10	Inserted into the soil to water the plant root directly
	Straight Barb Fitting	3	Connecting water pipes
	T Barb Fitting	10	Split water and connect pipes
	Cross Barb Fitting	3	Split water and connect pipes

	Detachable Hook	1	Put it on the timer to make the timer hangable
	Check Valve	1	Prevents water from backing up in the pipes back to the pump

3. Specification

Working Pressure	0.3Bar
Water Flow	30L/H
Water Proof	IPX2
Pumping Head	2-3m
Pumping Distance	2-3m
Maximum Water Pressure	≥200kPa
Working Temperature	3°C to 50°C(37°F-122°F)
Power By	USB cable (included) or 4*AA batteries (excluded)
Material	ABS

FCC STATEMENT: (FCC ID:2AWDBTTP106W)

This device complies with Part 15 of the FCC Rules. Operation is subject to the following two conditions:

- (1) This device may not cause harmful interference, and
- (2) this device must accept any interference received, including interference that may cause undesired operation.

FCC Warning: Any changes or modifications not expressly approved by the party responsible for compliance could void the user's authority to operate this equipment.

Note: This equipment has been tested and found to comply with the limits for a Class B digital device, pursuant to Part 15 of the FCC Rules. These limits are designed to provide reasonable protection against harmful interference in a residential installation. This equipment generates, uses, and can radiate radio frequency energy and, if not installed and used in accordance with the instructions, may cause harmful interference to radio communications. However, there is no guarantee that interference will not occur in a particular installation. If this equipment does cause harmful interference to radio or television reception, which can be determined by turning the equipment off and on, the user is encouraged to try to correct the interference by one of the following measures:

- Reorient or relocate the receiving antenna.
- Increase the separation between the equipment and the receiver.
- Connect the equipment into an outlet on a circuit different from that to which the receiver is connected.
- Consult the dealer or an experienced radio/TV technician for help.

Note: The manufacturer is not responsible for any radio or TV interference caused by unauthorized modifications to this equipment. Such modifications could void the user's authority to operate the equipment.

EC REP

NAME: VIAJE ELECTRONIC COMPANY LIMITED

ADDRESS: E588, 13 ADELAIDE ROAD, DUBLIN, D02 P950, IRELAND

Email: VIAJEELE@outlook.com



Not included



SIMPLE TO PAIR WIFI -----

1. Initial RainPoint App Setup



Rainpoint



1.1 Search for "RainPoint" and download Android version or iOS version App for free. Or scan the QR code to download Rainpoint APP.

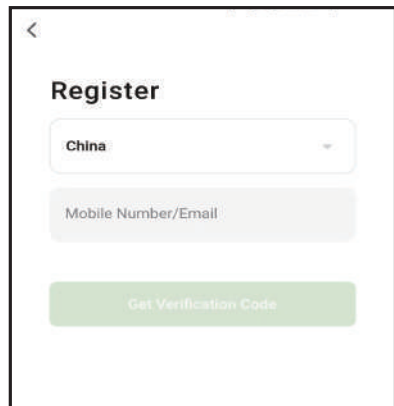

1.2 Create an account and login or login with an existing account to begin pairing with Wi-fi water pump

2. Pair the water pump

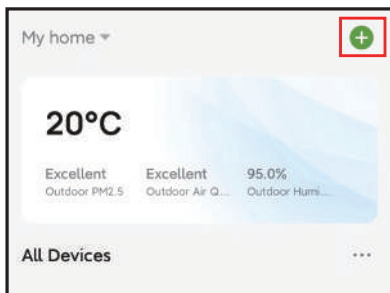

2.1 Click the button  or  on the home page of the APP

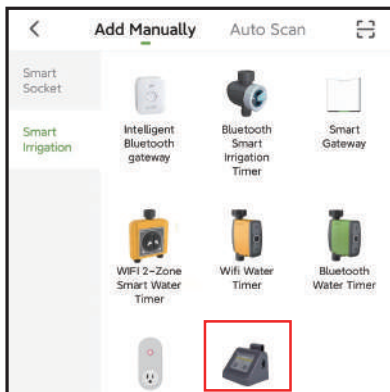

2.2 Choose "Add Manually" and "Smart rrigation", and then click then click "Wi-Fi Water Timer with Pump"



2.3 Select 2.4GHz Wi-fi Network and enter password.
Then click "next".

Note:

Rainpoint Wi-fi water pump only pairing with a 2.4GHz Wifi, for a dual-band router, please independently enable 2.4GHz WiFi band and name it differently from 5GHz WiFi band. Please click and follow the "Common Router" Setup Methods to separate them .

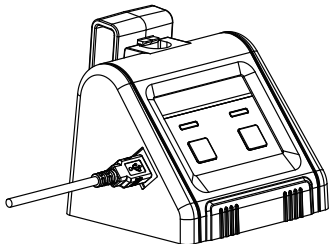

 **2.4 Always powered by USB cable (Included) for wifi connection and remote control.**

Light flashing guide	
Powered up and not paired	Flashes quickly(once a second)
Powered on and no network	Flashes slowly (once every 2 seconds)
Powered on and paired (Network connected)	Flashes always on

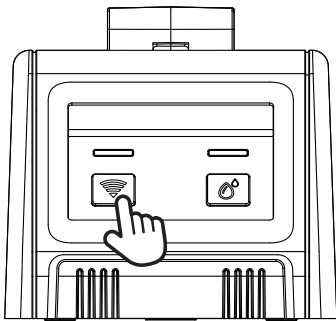

2.5 Press and hold 5 seconds of  WIFI button until the indicator light blinks once per second.

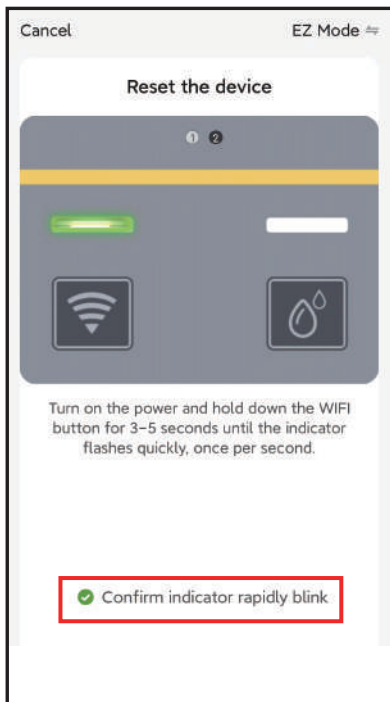

2.5 Powered the pump with USB cable and follow the instructions on the APP to reset first . Then click" ✓ "to confirm indicator rapidly blink and click "Next" to enter the pair mode.

Note:

- Pairing Wifi and accessing APP requires high current support , so make sure the USB cable is powered on before pairing
- Press and hold  button until the indicator light blinks quickly .

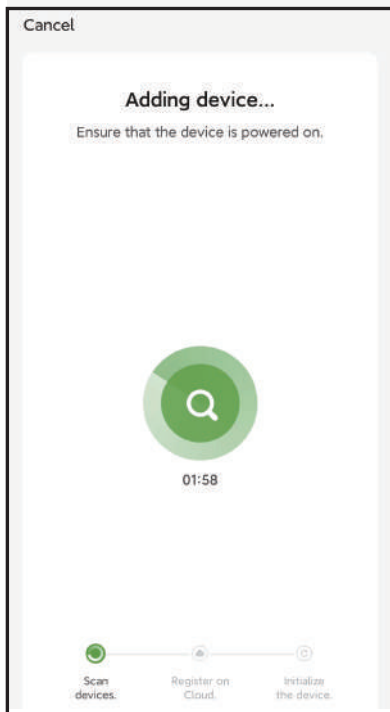

2.6 Wi-Fi pairing requires about 1-2 mins,once the device is paired successfully, the APP will show "Device added successfully".

Note :

- You can customize the name of the device as required.
- If you have not been able to pair for over 2 mins, please go to page 16 and follow the instructions to fully reset the device and start pairing again from the beginning.

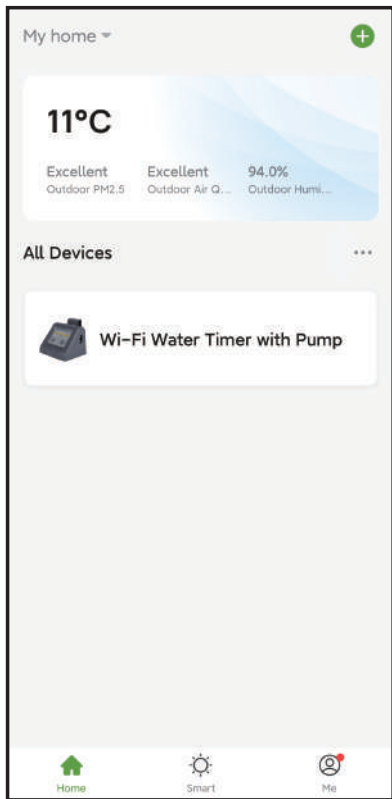

After pairing, you can remotely manage multi-watering plans, notifications will be sent to APP when "Automatic" watering plans are active or pump is out of water. it's perfect to take care of your potted plants when busy with chores or away on vacation.

We recommend using USB cable for power supply when a plug is available. If there is no plug at the place where you need to use the water pump, please take the water pump to the place where there is a plug to match the APP first, and then take it to the use position to use the battery power supply.

EASY TO INSTALL -----

1.1 Insert 4*AA 1.5V alkaline batteries

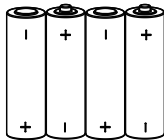
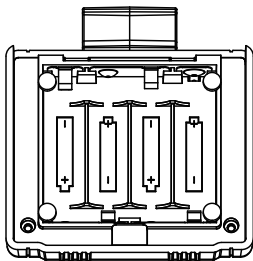

Battery power supply is only suitable for timed watering and manual watering that have been set to run, and cannot be remotely controlled.

- 1) Remove the battery tray back of the pump.
- 2) Insert 4 brand new AA (1.5V) alkaline batteries (not included) as the marked "-", "+" direction.
- 3) Firmly reinstall the battery cover back into the pump.
- 4) Once the pump is powered on, the indicator will light up when you press  button.

Note:

- Firmly restore the battery cover to ensure water resistance.
- When it is idle, please remove the battery and store it properly.
- Used up batteries must be removed from the pump.
- Do not dispose of batteries in the fire, which may cause explode or leak.

1.2 Plug in the cable of the USB port

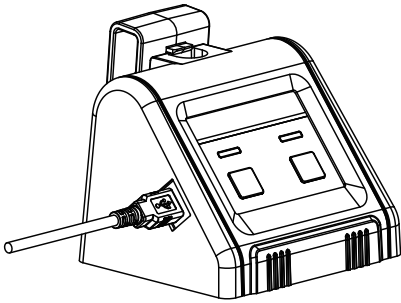

WiFi connection and remote control must keep the USB connection powered, otherwise the WiFi function will not work.

- 1) Plug in the USB cable (included)
- 2) When the power is on, the  indicator will light up.

Note:

- High current supply is required for pairing WiFi and accessing APP, so it is only available in USB cable-powered mode.
- WiFi pairing and APP access are not available in battery-powered mode.
- Battery-powered mode can only support manual watering.
- When both power modes are used simultaneously, it will match the USB cable power first; when the USB cable is disconnected, the battery-powered mode will be activated.

2. Determine the correct placemen

2.1 Please do not put the pump below the water level of the reservoir to effectively avoid the siphoning phenomenon. (The siphoning effect will cause the water leaking and over-watering problem)

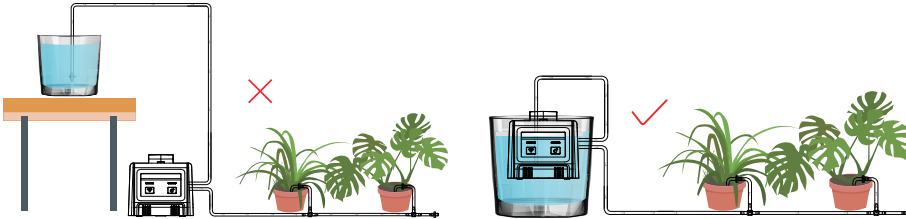

2.2 The lift length of the water pump: the vertical distance of 2-3m, because the water pipe can not be placed 100% straight, we recommend that the height between the plants and pump should not exceed 2.5m.

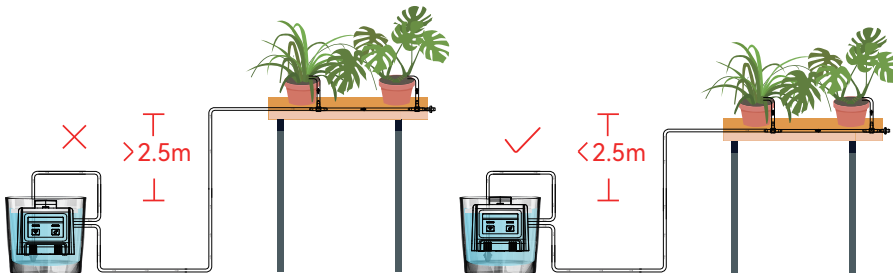

3. Connect the hose correctly

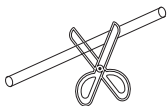

3.1 Cut the hose according to the distance of the device, the plant or you need

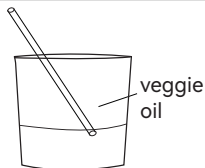

3.2 Put the head of hose into hot water for 10s or Put a little veggie oil on the end of the hose before connecting

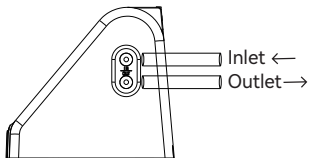

3.3 Connect the hose to water inlet and outlet

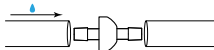

3.4 Connect the check valve to the water outlet near the pump. Using a check valve may reduce water pressure. (The check valve must be installed correctly in accordance with the flow direction)

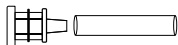

3.5 Insert the other end of the hose connected to the water inlet of the pump with the filter, and then put it into the container.



3.6 Connecting the suitable barb fitting

1) If only the hose needs to be connected, you can use straight barb fitting

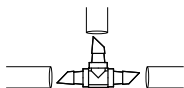

2) When you need to connect the hose while splitting to twoways, you can use the "T" barb fitting

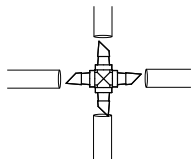

3) When you need to connect a hose while splitting to other 3 ways, you can use the cross barb fitting

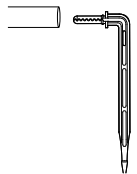

3.7 When water needs to be delivered to the soil, you need to use the micro drip emitters

Tips:

Loosen the soil first, then insert the drips at least 3 inches deep, which will help water enter the plant roots.

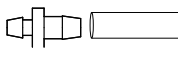

3.8 Please install Tubing End Caps after water flows out from the end of the pipe to avoid air in the pipe so that the water cannot flow smoothly to the end of the pipe.

4. Installation completed and tested

- 4.1 Press the  button to activate the pump, then the water will pumped to your plants.
- 4.2 Check if there is any leakage in the connection part of the hose. if so, it means no tightening, please keep tightening until no leakage.
- 4.3 After testing with no usage problems, go to the next step: WiFi pairing and programming plans.

APP INTERFACE OVERVIEW

1. Home Interface

The screenshot shows the app's Home Interface. At the top, it says "My Home" with a dropdown arrow. Below this is a weather forecast card showing "66°F", "Excellent Outdoor PM2.5", "Good Outdoor Air Q.I.", and "30.0% Outdoor Humid...". Below the weather card is a list of device categories: "All Devices", "lawns", "greenhouse", and "po...". Below the categories is a device card for "Wi-Fi Water Tim...". At the bottom is a navigation bar with three icons: "Home" (a house icon), "Smart" (a sun icon), and "Me" (a person icon).

Weather Forecast
Get the weather data for the town you selected.

Add Device
To add multiple Rainpoint smart devices.

Created Home
Customize home names of the different irrigation areas by entering "My Home".

Added device(s):
Click on your device then start your irrigation settings.

2. Irrigation Schedule Settings

The screenshot shows the 'Wi-Fi Water Timer with Pump' app interface. At the top, there is a title bar with a back arrow, the text 'Wi-Fi Water Timer with Pump', and a settings icon. Below the title bar is a large green area with a dashed box containing a circular timer showing 'Next Irrigation 0_D 0_H 25_M'. Below this, it says 'Remaining Watering Time: 00:00' and 'Working Status: Idle'. At the bottom of the green area is a 'Switch' with a toggle. Below the green area are three settings cards: 'How Often' set to '0_D 0_H 1_M', 'How Long' set to '00_M 30_S', and an 'Auto Run' button with a green checkmark icon.

Next Irrigation
Countdown for the next irrigation

Automatic Watering Mode
Watering Frequency:
1 hr to 7 days
Watering Duration:
20s to 30 mins

Auto Run
Click to start running the schedule you setup.

Device Information
According to your needs to set, please refer to Page.

Battery Status
For different battery status, refer to Page to view.

Manual Watering Switch
Turn ON/OFF manual irrigation as needed, refer to Page to view setting tips.

3. Device Information

Offline Notification
Open: send a message to APP when device is offline.

Remove Device
Remove the device before resetting it, refer to Page to view.

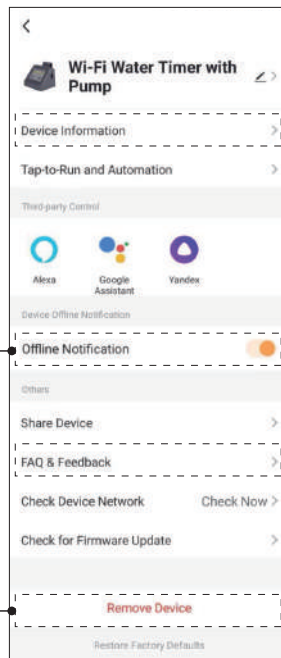

Virtual ID For Device



FAQ & Feedback
Asking support and feedback questions.

4. Smart Function Interface

Automation Function.

Customize multi-irrigation plans with Meteorological changes.

Tap-to-Run Function.

Set and control multiple devices and plans.

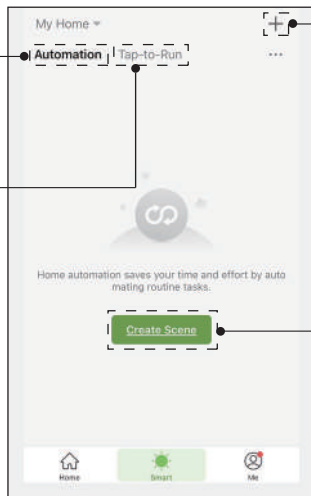

Add Watering Plan.

Click to set the conditions and tasks for your plan.

Notice:

1. "Automation" and "Tap-to-Run" are different on function and setting. "Automation" is mainly for creating the new smart plan, while "Tap-to-Run" is mainly for easy control on the existing smart plans.
2. **Make sure your device is always connecting and staying online to run Automation as normal. please keep the usb cable connecting on the device to keep the timer online.**
3. The "notice" function in Automation is ON only if you set it up in task.

4.1 Condition Settings

Setup arguments and add conditions as your required.

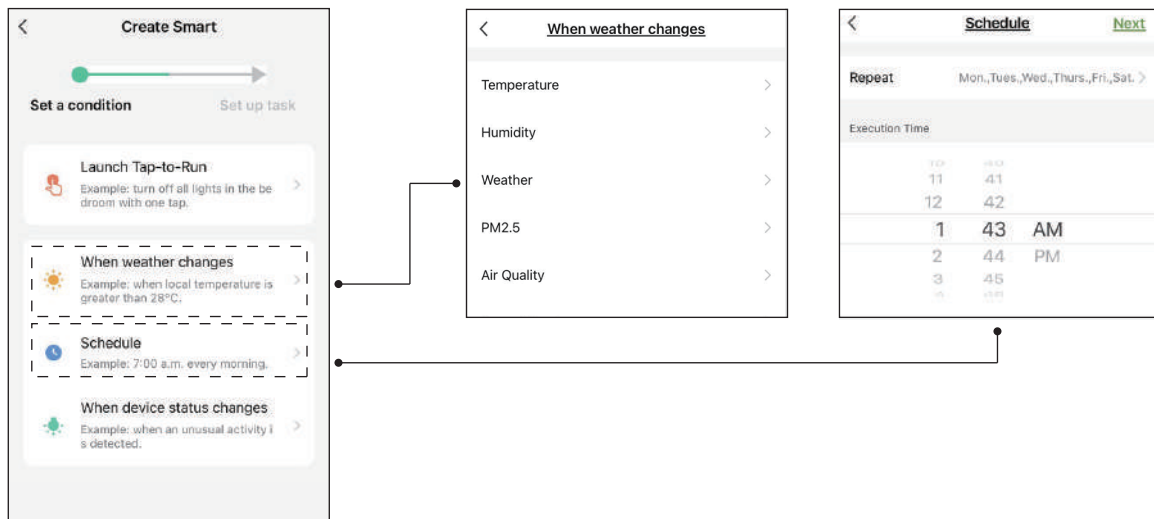

4.2 Task Settings

Set up tasks as your required, then trigger task if conditions are met.

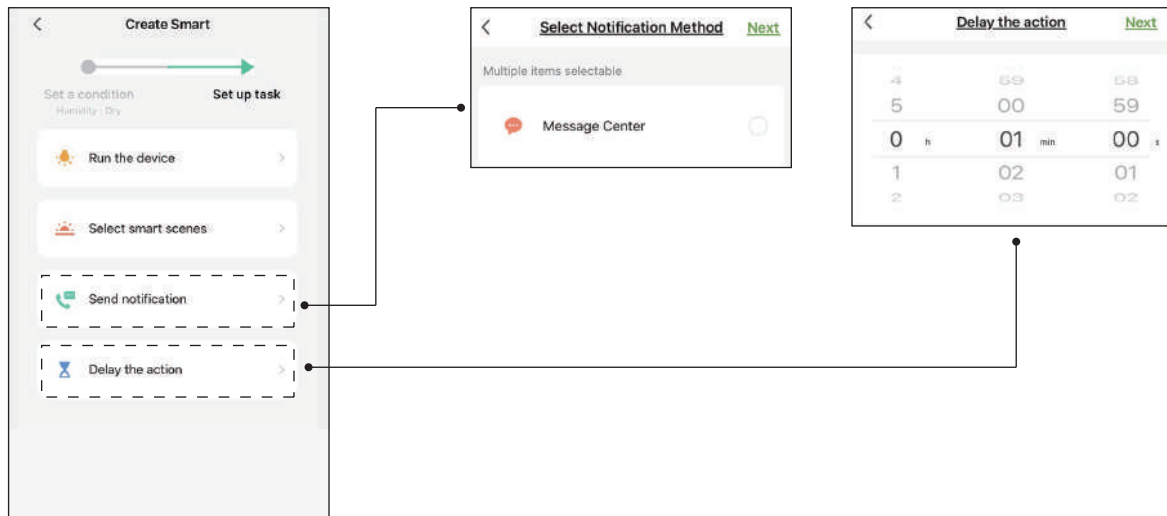

5. Personal Date Interface

Setup arguments and add conditions as your required.

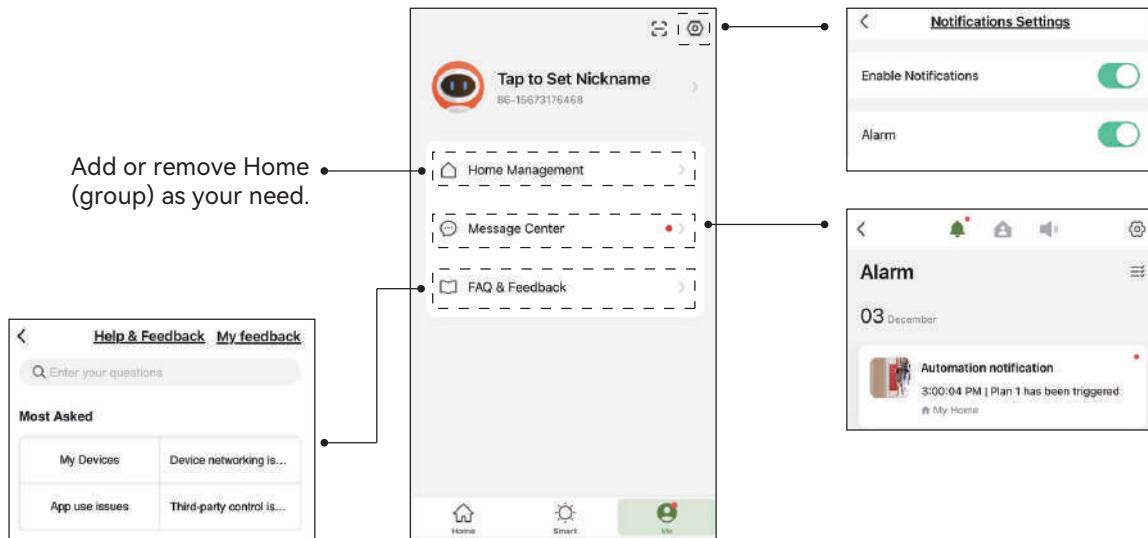



AUTOMATIC WATERING MODE -----

Step1: Click ◀ to setup watering frequency as your required and "done" it.

The screenshot shows a configuration window for automatic watering. It has a dashed border and contains three sections. The top section is labeled 'How Often' and shows the value '7_D_00_H' with a left-pointing arrow icon to its right. The middle section is labeled 'How Long' and shows the value '00_M_07_S' with a left-pointing arrow icon to its right. The bottom section features a green checkmark icon inside a circle, with the text 'Auto Run' centered below it.

Step2: Click ◀ to setup watering duration as your required and "done" it.

Step3: Click  and change  it to green .Means that your schedule is running.

Note:

Please remember to activate step 3 after the setup is completed, otherwise the program won't run.

MANUAL WATERING MODE -----

1. Manual Operation Via App

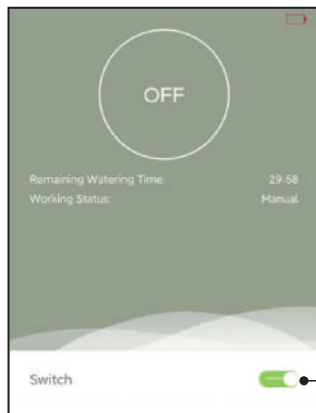

•Click the switch to turn ON / OFF manual watering.

2. Manual Operation Via Device



Click the watering button to turn ON / OFF manual watering.

RESET THE DEVICE -----

1. Remove the device and erase the data on the app, then cut off the power (remove the battery and unplug the USB cable).
2. Leave the device for about 30-60s.
3. Plug in the USB cable, press and hold the WiFi button until the indicator turns to a fast blinking green light, then open the APP to connect.

TROUBLESHOOTING -----

Problem	Possible Cause	Possible Solution
WiFi can't be connected	Not in 2.4GHz wifi channel connection	Reset the router for a 2.4G channel and reconnect.
	Too far between the pump and router, causing the signal unstable	Move the pump to a closer socket near the router and reconnect.
	Not in the correct connecting mode	Unplug the USB cable and battery first and wait 10 Sec. Charge the pump with USB cable again, then hold down WiFi button until the indicator light flashes rapidly and enter pairing mode.

Problem	Possible Cause	Possible Solution
Uneven water flow	Too far away from pots and water containers or too long pipes can reduce the pump's pumping efficiency.	The further away from the pump the potted plant is, the weaker the water flow will become. Please use some clamps to hold the first few branches so that the mainstream water can be delivered quickly and for a long time.
Hard to insert and remove water pipes	Because of the material, in order to make the pipe more durable.	Put the head of hose into hot water for 10s or Put a little veggie oil on the end of the hose before connecting.
Watering schedule not on time	The lack of water at the inlet resulted in the plan not being implemented on time.	Check if there is a lack of water in the container at the inlet. (If there is a leakage the schedule will not running)
	There is no auto-run schedule set up on the APP side.	Once the plan parameters have been set, the plan will be executed automatically according to the parameters set by checking "Auto Run".
	The water pump unexpectedly lost power and the plan was emptied.	The watering schedule needs to be reset.
<p>If your Rainpoint product does not operate properly after trying the troubleshooting steps, please contact us by phone or email : US: 1-833-381-5659 (EN)(MON-FRI 9:30 AM-5:30 PM PST) EU: +44 800-808-5337 (EN DE)(MON-FRI 9:00 AM-5:00 PM CET) Email: service@rainpointus.com</p>		

WARRANTY -----

Rainpoint provides a 1-year limited warranty on this product against manufacturing defects in materials and workmanship.

CUSTOMER SUPPORT -----

If you find it difficult to set up and want to watch the setting tutorial video, please subscribe to our channel: RainPoint on YouTube.

 Support: <https://www.rainpointonline.com/pages/support>

If you can not solve the problem of this time with this manual, please contact us with the LOT NO. of your device. There will be a private service for you.

LOT NO.: XXXXX (on the back of the timer)

US Free Hotline(English): +1 833-381-5659

(MON-FRI 9:30 AM-5:30 PM PST)

UK Free Hotline(English Deutsch): +44 800-808-5337

(MON-FRI 9:00 AM-5:00 PM CET)

Email: service@rainpointus.com

WhatsApp: +1 626-780-5952