



RainPoint[®]
More Than Water Saving

Smart⁺ Garden Irrigation System

USER MANUAL

Water Flow Meter

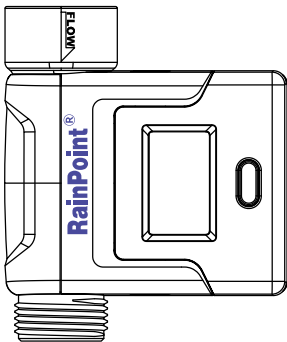

Model No. HCS008FRF



Web: www.rainpointonline.com



Email: service@rainpointus.com



WhatsApp: +1 626-780-5952



US Free Hotline(English): +1 833-381-5659

(MON-FRI 9:30 AM-5:30 PM PST)

EU Free Hotline(English Deutsch): +44 800-808-5337

(MON-FRI 9:00 AM-5:00 PM CET)

What in the box

A. HCS008FRF Water Flow Meter

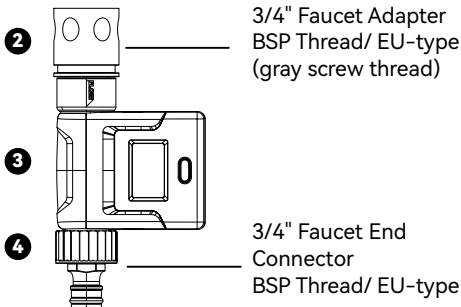

B. (For NH thread/ USA-type)

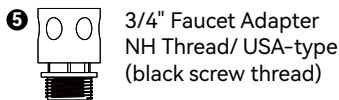
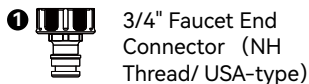

C. (For BSP thread/ EU-type)

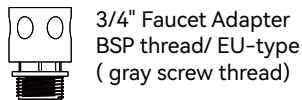
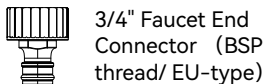

Note: B and C will be presented according to the country region, two sets of accessories will not be included in the product at the same time.

CONTENT

1. INTRODUCTION	01
1.1 Product Overview	01
1.2 Specification	01
1.3 Product Features	01
2. CONNECTION AND INSTALLATION	02
2.1 Flow Meter Connection	02
2.2 Installation	05
3. APP FEATURES AND FUNCTIONS	06
3.1 Device Home Page	06
3.2 Basic Setting	07
3.3 Statistics	07
3.4 Charts	08
4. TROUBLESHOOTING	09
5. NOTES	10
6. WARRANTY POLICY	10
7. FCC STATEMENT	11
8. CUSTOMER SUPPORT	12

1. INTRODUCTION

1.1 Product Overview

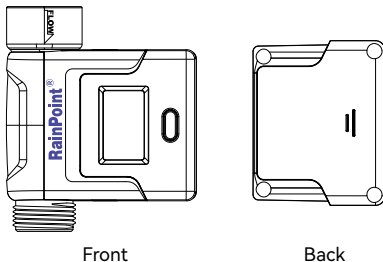

1.2 Specification

- inlet and outlet 3/4"
- water rate 20 L/H to 2400 L/H
- working water pressure 0.5 bar to 8 bar (7-116 psi)
- accuracy $\pm 5\%$
- communication distance with hub about 60m
- powered by 3*AAA alkaline batteries
- waterproof IPX6

1.3 Product Features

- current water flow rate and consumption checking on both LCD and APP
- hourly, daily and monthly water consumption checking via APP
- split type design
- Liter and Gallon switchable
- sleep mode for saving power
- low power alert notification
- water usage warning and correction on APP

2. CONNECTION AND INSTALLATION

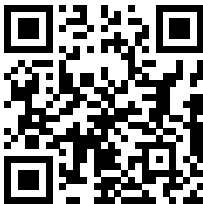

Please scan the QR code or search the link to access the video to connect the device quickly and easily.

Set Video:

<https://www.youtube.com/watch?v=P2yXpW3ewkl>

2.1 Flow Meter Connection

This device is a sub-device, please connect the hub of Rainpoint Smart+ series before connecting this device.

1. After the hub is successfully connected. Select the **+** button on the top right corner of the APP home page to add device, or you can go to the hub's home page and use "Sub-devices" to add devices.



2. Find “Flow Meter” or the icon  to add the sensor.

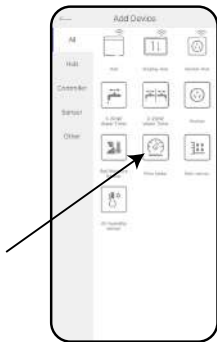

3. Insert the batteries, and then the indicator will quickly blink in red.

Tips: Pull out the detector and use the tool to unscrew the four screws of the back cover.

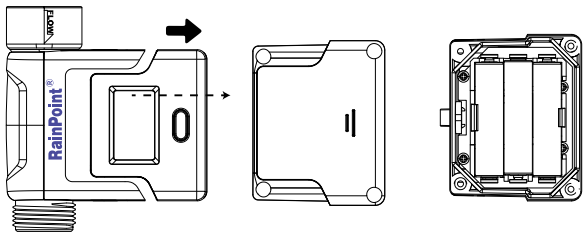

4. At the same time, select “**NEXT**” on the APP and start searching devices.
5. Keep the sensor and the hub close to each other to connect automatically.
6. Besides that, you can also re-insert the batteries to reset and reconnect if you fail to connect for the first time.
7. After successfully connecting, the real-time water flow rate and other information will show on the device home page.



2.2 Installation

Option 1: Install the flow meter on the faucet and tighten it hard.

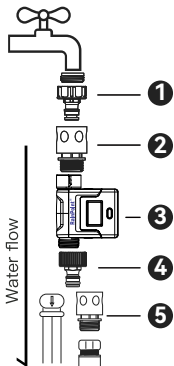

Option 2: Connect the flow meter with tubes or hose nozzle.

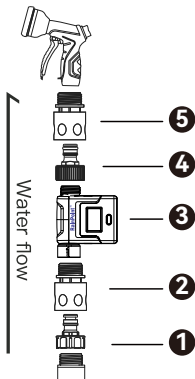

- 1 3/4" Faucet End Connector (NH Thread/ USA-type)
- 2 3/4" Faucet Adapter BSP Thread/ EU-type (gray screw thread)
- 4 3/4" Faucet End Connector (BSP Thread/ EU-type)
- 5 3/4" Faucet Adapter NH Thread/ USA-type (black screw thread)

Note:

- 1 and 5 are available in different type and will be differentiated by region.
- Please do not remove the connectors while using.
- The fitting 2 3 4 are indivisible parts. Do not split them.
- The fitting 1 and 4, 2 and 5 are different in the type of thread. Do not change the installation sequence of the fittings.
- Please follow the flow direction point out on the meter's body.
- The work distance is within 320 feet in open area. Please do not leave the sensor so far from the hub.

3. APP FEATURES AND FUNCTIONS

3.1 Device Home Page



1. **Setting:** Basic settings for the sensor

2. **Real-time flow rate**

3. **Data display:**

- Current water usage
- Last water usage
- Current time
- Last time
- Totay cumulative
- Total cumulative

4. **Charts:** Check the water flow in 24 hours, 30 days, and 12 months

3.2 Basic Setting

Find the icon on the top right corner of the APP home page to "Settings" page. In the basic settings, you can check and manage the device information, such as name and interface.



3.3 Special features

Water Usage Warning: Detect the water usage in hours and send a warning notification if the water usage exceeds the standard.

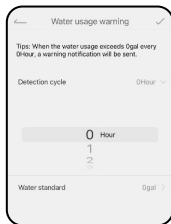

Water Usage Correction: Correct the water usage value in percentage if needed.



Data Reset: Clear the water usage record in this device.

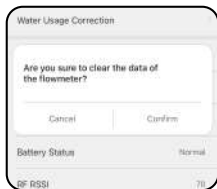
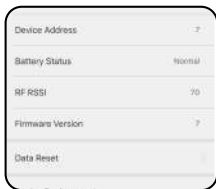

3.4 Charts

Select **Charts** to review your water consumption hourly, daily and monthly in a bar graph.



If you need more detail information about the operation, please scan the QR code or search the link to access the video to check the device quickly and easily.

Setup Video: <http://bit.ly/3WMKuYF>



4. TROUBLESHOOTING

Problem	Possible Factors	Solution may help
Fail to connect with the hub	<ol style="list-style-type: none">1. Wi-Fi signal unstable.2. Distance between sensor and hub is too far.3. WiFi is not 2.4GHz	<ol style="list-style-type: none">1. Wait a little bit and try to connect one more time by re-insert the batteries.2. Stay closer to the hub while connecting.3. Please connect 2.4GHz WiFi before connecting to hub.
Lose connection or get offline on the APP	<ol style="list-style-type: none">1. Low battery.2. Hub disconnected.3. Wi-Fi signal unstable.	<ol style="list-style-type: none">1. Change brand new batteries.2. Check the hub and reconnect it if disconnected. Then run the water through out the flow meter a little bit.3. Re-insert the batteries to get into pairing mode again.
Data inaccurate or incorrect	<ol style="list-style-type: none">1. Insufficient water flow in the water pipe.2. Not follow the recommended flow direction.	<ol style="list-style-type: none">1. Increase the water pressure or water flow to fill the pipe diameter.2. Re-install the flow meter following the flow direction.

Water leakage	<ol style="list-style-type: none"> 1. The quick connector is not tightened on the flow meter. 2. Battery cover screws not tightened. 	Tighten the connectors and screws before installation.
<p>If you need more help about the product or anything about us, please contact us US: 1-833-381-5659 (EN)(MON-FRI 9:30 AM-5:30 PM PST) EU: +44 800-808-5337 (EN DE)(MON-FRI 9:00 AM-5:00 PM CET) Email: service@rainpointus.com</p>		

5. NOTES

- Please make sure to use 2.4GHz band WIFI to connect to this product.
- Must tighten the screws before installing.
- Do not mix old and new batteries or different types of batteries.
- Under freezing temperatures, please keep the sensor away from snow to avoid potential freezing damage.
- Try to use it following the water flow direction.

6. WARRANTY

RAINPOINT provides a 3-year limited warranty on this product against manufacturing defects in materials and workmanship.

7. FCC STATEMENT: (FCC ID:2AWDBHCS008FRF)

This device complies with Part 15 of the FCC Rules. Operation is subject to the following two conditions:

- (1) This device may not cause harmful interference, and
- (2) this device must accept any interference received, including interference that may cause undesired operation.

FCC Warning: Any changes or modifications not expressly approved by the party responsible for

compliance could void the user's authority to operate this equipment.

Note: This equipment has been tested and found to comply with the limits for a Class B digital device, pursuant to Part 15 of the FCC Rules. These limits are designed to provide reasonable protection against harmful interference in a residential installation. This equipment generates, uses, and can radiate radio frequency energy and, if not installed and used in accordance with the instructions, may cause harmful interference to radio communications.

However, there is no guarantee that interference will not occur in a particular installation. If this equipment does cause harmful interference to radio or television reception, which can be determined by turning the equipment off and on, the user is encouraged to try to correct the interference by one of the following measures:

- Reorient or relocate the receiving antenna.
- Increase the separation between the equipment and the receiver.
- Connect the equipment into an outlet on a circuit different from that to which the receiver is connected.
- Consult the dealer or an experienced radio/TV technician for help.

Note: The manufacturer is not responsible for any radio or TV interference caused by unauthorized modifications to this equipment. Such modifications could void the user's authority to operate the equipment.

EC REP

NAME: VIAJE ELECTRONIC COMPANY LIMITED

ADDRESS: E588, 13 ADELAIDE ROAD, DUBLIN, D02 P950, IRELAND

Email: VIAJEELE@outlook.com

8. CUSTOMER SUPPORT

If you find it difficult to set up and want to watch the setting tutorial video, please subscribe to our channel RainPoint on YouTube.



Or scan the QR code to visit the RainPoint channel on YouTube quickly.

If the app and the user manual don't have what you're looking for, and need some help about Rainpoint, please contact us by LOT NO.: XXXXX (on the back of the device)

US Free Hotline(English): +1 833-381-5659

(MON-FRI 9:30 AM-5:30 PM PST)

EU Free Hotline(English Deutsch): +44 800-808-5337

(MON-FRI 9:00 AM-5:00 PM CET)

Email:service@rainpointus.com

WhatsApp: +1 626-780-5952



Made in China



Not included



Points de collecte sur www.quefairedemesdechets.fr
Privilégiez la réparation ou le don de votre appareil !