

USER MANUAL

Rainpoint 4-Zone Digital Water Timer

Model No. ITV405-DLS

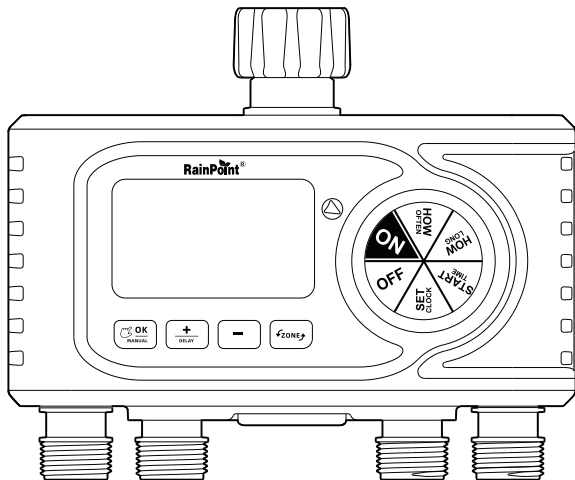

WHAT IN THE BOX

Rainpoint 4-Zone Water Timer x 1	
User Manual x 1	Quick Start Guide x 1
Sealing tap x 2	Brace x 1
Bracket accessory x 1	Thin shim x 2
Thick shim x 1	Small Screw x 2
Middle Screw x 1	Big Screw x 1
Nut x 1	Raw material belt x 1

OVERVIEW

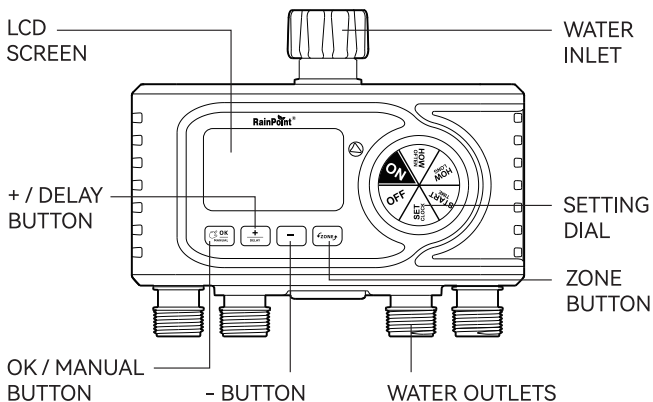

IMPORTANT! PLEASE READ!

- PLEASE ACTIVATE THE VALVE BEFORE USE IF YOU ARE USING IT FOR THE FIRST TIME OR AFTER A PERIOD OF IDLENESS TO ENSURE YOU CAN USE IT PROPERLY: BEFORE FIRST TIME USE, TO ACTIVATE THE TIMER WITH AUTO-TEST MODE, HOLD THE OK BUTTON WITHOUT RELEASING AND THEN INSERT BATTERIES. THE TIMER WILL AUTOMATICALLY TURN ON AND OFF THE VALVES TO TEST AND ACTIVATE. TAKE OUT THE BATTERIES AND RE-INSERT TO GET THE TIMER BACK TO WORK NORMALLY..(EXPLANATION:IN MOST CASES,THE VALVE IS ACTIVATED,BUT DUE TO EXTERNAL FORCES OR THE ENVIRONMENT DURING STORAGE AND TRANSPORTATION BY A VARIETY OF FACTORS,THE VALVE MAY APPEAR TO CLOSE ON ITS OWN,THEN IT NEEDS TO BE ACTIVATED MANUALLY.)
- ONLY USE WITH CLEAN COLD WATER.
- FILTER TRAPS DIRT PARTICLES PROLONGING THE LIFE OF THE PRODUCT.CLEAN FILTER REGULARLY AND REPLACE IF WORN.
- WHEN EXPECTING FREEZING TEMPERATURES,TIMERS SHOULD BE REMOVED FROM THE HOSE FAUCET AND STORED INDOORS TO AVOID POTENTIAL FREEZE DAMAGE.
- FOR ANY PROBLEMS DURING USE,PLEASE GET SUPPORT AS FOLLOWS:

 Web: www.rainpointonline.com

 E-mail: service@rainpointus.com

 US Free Hotline(English): +1 833-381-5659

(MON-FRI 9:30 AM-5:30 PM PST)

UK Free Hotline(English Deutsch): +44 800-808-5337

(MON-FRI 9:00 AM-5:00 PM CET)

BUTTON FUNCTION INTRODUCTION



Dial Functions	
ON	Run the timer as scheduled
OFF	Turn off the timer
SET CLOCK	Set current time
START TIME	Set the time to start watering
HOW LONG	Set the duration of watering plan
HOW OFTEN	Set the frequency of watering plan



Button Functions	
OK/MANUAL BUTTON	Confirm settings or water manually
+/DEALY BUTTON	Adjust settings or set delay watering
- BUTTON	Adjust settings
ZONE BUTTON	Switch watering zone when setup

SPECIFICATION

- Four 1" or 3/4" inlet and 3/4" outlet
- Working water pressure 0.5 bar to 8 bar (7.25-116 PSI)
- Flow rate 22 L/min (5.8 Gal/min)
- Powered by 4xAA batteries (not included)
- IPX4 water proof

INSTALLATION

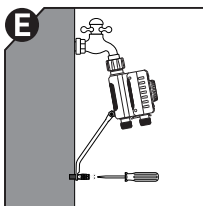
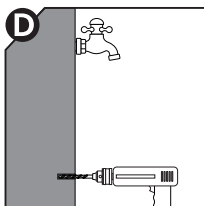
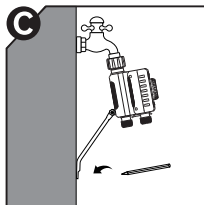
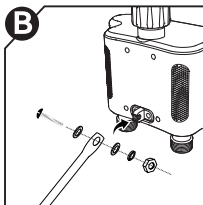
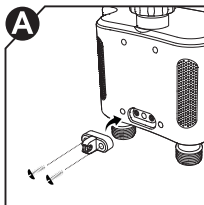

- A** Screw the supporting part on the back of the water timer.
- B** Use the screw to install the bracket accessory onto the supporting part through the hole.
- C** Install the timer on the tap and mark a proper position before install the brace.
- D** Drill a hole for screwing.
- E** Attach the brace with the screw.

FUNCTIONS

SET CLOCK

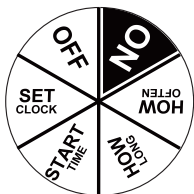
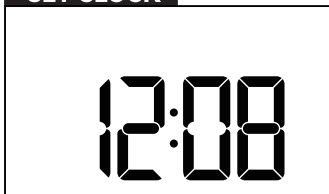

- 1) Turn the dial to **SET CLOCK**.
- 2) Use **+** and **-** buttons to set the hours, then press **OK** to confirm and set minutes. Hold buttons for 3 seconds to quickly adjust.
- 3) Press **OK** to make a final confirm after set up minutes and then everything stops blinking. At this time, **ONLY** press **+** and **-** button to set up time again.
- 4) At any time during clock setup, press and hold the **OK** button to switch **12H/24H** time format.
- 5) After finishing setup, turn the dial to **START TIME**.

FUNCTIONS

START TIME

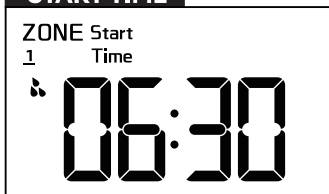

- 1) Turn the dial to **START TIME**.
- 2) Use **+** and **-** buttons to set the hour of the watering start time, then press **OK** to confirm and set minutes. Hold buttons for 3 seconds to quickly adjust.
- 3) Press **OK** to make a final confirm after set up minutes and then everything stops blinking. At this time, **ONLY** press **+** and **-** button to set up time again.
- 4) During setting, press **ZONE** button to switch the zone of setting.
- 5) After finishing setup, turn the dial to **HOW LONG**.

FUNCTIONS

HOW LONG

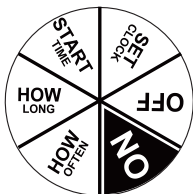
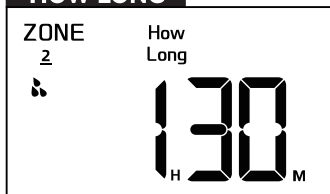

- 1) Turn the dial to **HOW LONG**.
- 2) Use **+** and **-** buttons to set the hour of the watering duration, then press **OK** to confirm and set minutes. Hold buttons for 3 seconds to quickly adjust.
- 3) Press **OK** to make a final confirm after set up minutes and then everything stops blinking. At this time, **ONLY** press **+** and **-** button to set up time again.
- 4) The maximum watering duration can be set is 3 hours and 59 minutes. When set the time to 0 hour and 0 minute, it means the plan will not run.
- 5) During setting, press **ZONE** button to switch the zone of setting.
- 6) After finishing setup, turn the dial to **HOW OFTEN**.

FUNCTIONS

HOW OFTEN

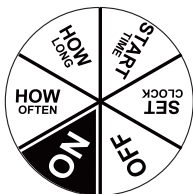
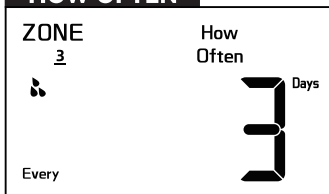

- 1) Turn the dial to **HOW OFTEN**.
- 2) Use **+** and **-** buttons to set watering frequency, then press **OK** to confirm and set minutes.
- 3) Press **OK** to make a final confirm and then everything stops blinking. At this time, **ONLY** press **+** and **-** button to resume set up.
- 4) The options of the frequency is every 8 hours, 12 hours, and 1 to 7 days.
- 5) During setting, press **ZONE** button to switch the zone of setting.
- 6) After finishing setup, turn the dial to **ON** to run the watering schedules.

MORE FUNCTIONS

Manual Watering Mode

ZONE

1 2 3 4



- 1) When the dial stays in **ON**, press and hold **OK** button for 3 seconds to enter manual watering model.
- 2) First, set the zone preferred to manually water. Zone 1 will start blinking. Short press **ZONE** button to switch zone options and use **OK** button to select.
- 3) After selecting zones, hold the **ZONE** button to confirm and go to manual water duration setup.
- 4) The minute will blink. Use **+** and **-** buttons to set time. Hold buttons for 3 seconds to quickly adjust.
- 5) Press **OK** button to start manual watering at once, or leave it without any operation for 5 sec to automatically start.
- 6) When manual watering, hold **OK** button again to stop, or turn dial to **OFF** to stop.

MORE FUNCTIONS

Delay Mode



When the dial stays in **ON**, press and hold the **+** button for 3 seconds to enter the delay mode setting. Press **+** and **-** button to set the delay time for 0, 24, 48, or 72 hours, and press **OK** button to confirm. Select 0H will cancel the delay mode. If there is no action within 5 seconds, then it will cancel the delay mode as well.

During the delay mode opening, hold the **+** button to cancel the delay.

Note :

- 1) When one watering plan has more than one valve to run, then the timer will open the valve one by one in the order of zone number, which means the timer can only open **ONE** valve at a time.
- 2) The four channels cannot be opened at the same time, only one channel can be opened at a time. When the start time of the four channels is the same, priority will be given to opening one channel, and when the execution of one channel is completed, the execution of the second channel, then the third channel, and then the fourth channel will begin.

MORE FUNCTIONS

Off Mode

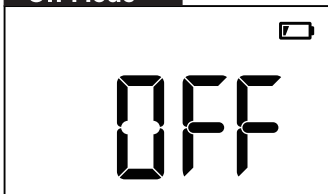

- 1) If you wish to stop all watering plan for an extended period, turn the dial to "OFF". (Your settings are saved)
- 2) The timer will not water automatically while in OFF mode. (The screen will display the word OFF in large letters)
- 3) To start watering automatically again, turn the dial back to "ON" to resume your programmed watering schedule.

BATTERY STATUS

Battery Status will be displayed as following:

 Low Power

Note: When the low battery indicator appears on display, the valve will close automatically to avoid leakage. Please replace the battery in time in case of interrupting the normal operation.

TROUBLE SHOOTING

Problem	Possible Factors	Solution may help
Condensation on the screen	<ul style="list-style-type: none"> • Air condenses inside the screen due to the difference in temperature between inside and outside. 	<ul style="list-style-type: none"> • The fog will disappear as the temperature rises, or leave it stand for a period of time.
Low water pressure	<ul style="list-style-type: none"> • Filter blockage. • Inlet pressure is not sufficient to support watering needs. 	<ul style="list-style-type: none"> • Check if the filter is clogged, if so, clean or replace the filter. • Make sure the timer is installed properly and not cross-threaded. • Install a booster pump or other booster pressurizing equipment
Timer does not water or has low water flow	<ul style="list-style-type: none"> • Batteries are low. • The dial does not turn to ON. • The faucet is not turned on. 	<ul style="list-style-type: none"> • Replace brand new alkaline batteries • Turn the knob of the dial to the ON position. • Turn on the tap.
Timer is leaking	<ul style="list-style-type: none"> • Filter washer lost or damaged. 	<ul style="list-style-type: none"> • Check if filter washer is in place. • Check if filter washer is clean and undamaged. • Faucet connection is hand tight.

WARNINGS

- 1) Intended for outdoor use only, put in the sheltered outdoor will prolong the product lifetime.
- 2) Using tools to tighten your timer is too tight, easy to damage, to avoid damaging the timer, please tighten it with your hand instead of a tool.
- 3) Please ensure that the filter is placed horizontally in the top connector before installation to prevent leakage, add a filter and thread seal tape if necessary.
- 4) Mesh filter prevents dirt particles, prolonging the life of the hose timer. Clean filter regularly and replace if worn.
- 5) When the power is low, please replace the batteries in time to avoid the interruption of the normal operation; when replacing the batteries, please make sure that the battery compartment is dry.
- 6) When not in use, remove batteries, drain and store indoors to away from freezing.
- 7) Do not use the timer which it's more than 122°F(50°C) or less than 37.4°F(3°C).
- 8) Do not subject the product to extreme force and shock.
- 9) Severe electrical shock could result if water is sprayed into outlets or sources of electrical current. Never immerse the product in water.



Made in China



Not included



Points de collecte sur www.quefairedemesdechets.fr
Privilégiez la réparation ou le don de votre appareil !

WARRANTY

Rainpoint provides a 1-year worry-free warranty against manufacturing defects in materials and workmanship from the date of purchase. During the warranty period, we'll replace free of charge the product found to be defective under reasonable use and service as determined solely by RainPoint.

To place a warranty request, please email your order ID to XXXXXXXXXXX and we'll respond within 24 hours.

CUSTOMER SERVICE

Still have trouble with setup, please search for “**RainPoint**” on YouTube for installation videos !

If the user manual doesn't have what you're looking for or you need some help, please prepare the LOT NO. of your device and contact us before returning the product to the store.



Scan the QR code to
get fast support

Need Help?
Please contact us
Email: support@rainpointus.com