

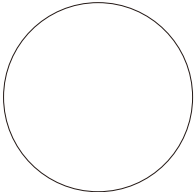

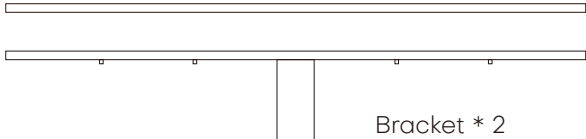

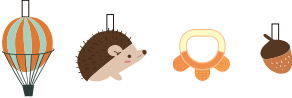

⚠️ WARNING:

1. CAUTION: Arches are under tension. Grasp firmly on both ends and be careful while removing to avoid injury.
2. IMPORTANT: Remove all packaging and fasteners before giving the product to a child. Retain this package for future reference. It contains important information. Require adults to assemble. For one family use only.
3. CLEANING INSTRUCTIONS: Machine wash in cold water, gentle cycle. Do not bleach. Air dry. Clean toys with a damp cloth and mild soap before use. Air dry. Do not immerse in water. Do not clean the inner cushion
4. During use, adults must be present and do not leave babies unattended.
5. This toy is not intended to be “mouthed” by the baby and should be positioned clearly out of reach of the baby’s face and mouth.
6. Always attach all provided fasteners (strings, straps, clamps, etc.) tightly to a playpen according to the instructions. Check frequently.
7. Do not add additional strings or straps to attach to playpen.

Components List

		
Mat Cover * 2	Inner Cushion * 1	
		
Bracket * 2		
		
Hanging Toy * 4	Plastic Ring * 6	Detachable Pillow * 1
		
Storage Bag * 1	Mirror * 1	User Manual * 1

Assemble Steps

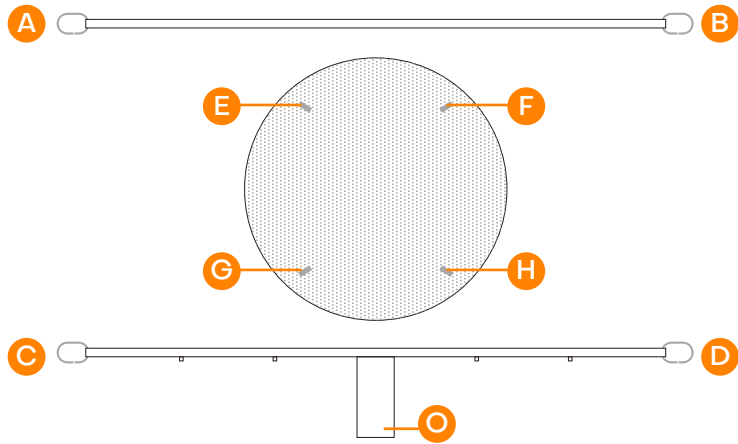

1. Fix bracket AB with nylon buckle EH and Fix bracket CD with nylon buckle FG.

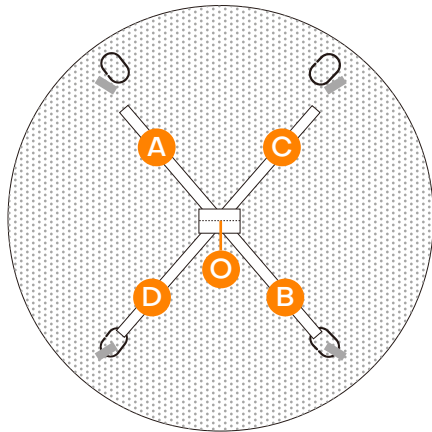

2. Fix the center of brackets AB and CD with Velcro O.
(Warm Tips: Put the bracket AB under the bracket CD.)

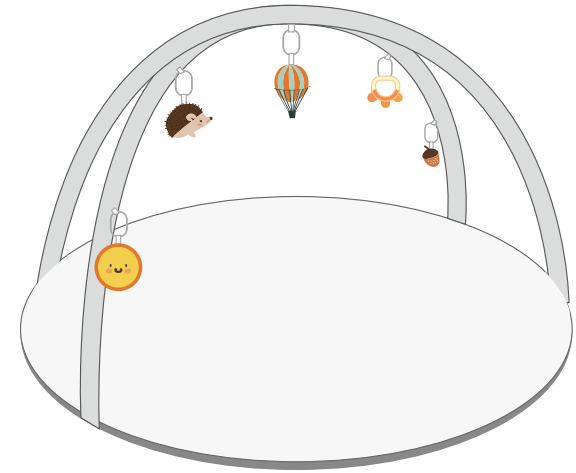

3. Hang the toys with the plastic ring on the cloth loop under the brackets.

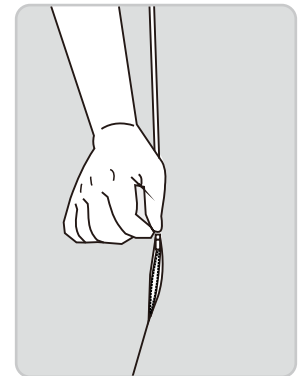





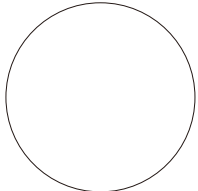
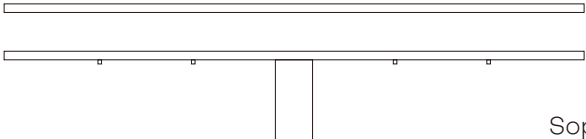
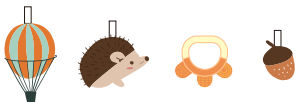

4. If you need to replace the mat cover, you can unzip it, put the inner cushion into the other mat cover and zip it up.

⚠️ **ADVERTENCIA:**

1. **PRECAUCIÓN:** Los arcos están bajo tensión. Sujete firmemente ambos extremos y tenga cuidado al retirarlo para evitar lesiones.
2. **IMPORTANTE:** Retire por completo el embalaje y los sujetadores antes de pasarle el producto a un niño. Conserve el paquete para futuras referencias ya que contiene información importante. Requiere mayores de edad para ensamblar. Solo para uso familiar.
3. **INSTRUCCIONES DE LIMPIEZA:** Lavar a máquina en agua fría, ciclo suave. No usar lejía. Secar al aire. Limpie los juguetes con un paño húmedo y jabón suave antes de usarlos. Secar al aire. No sumergir en agua. No limpie el cojín interior.
4. Durante el uso, un adulto debe de estar presente y no dejar al bebé desatendido.
5. Este juguete no está pensado para que el bebé se lo "lleve a la boca" y debe colocarse claramente fuera del alcance de la cara y la boca del bebé.
6. Coloque siempre todos los elementos de fijación suministrados (cuerdas, correas, abrazaderas, etc.) firmemente en el corralito de acuerdo con las instrucciones. Compruebe con frecuencia.
7. No añada cuerdas o correas adicionales para fijar el corralito.

Lista de Componentes

 <p>Cubierta * 2</p>	 <p>Cojín Interior * 1</p>	
 <p>Soporte * 2</p>		
 <p>Juguete Colgante *4</p>	 <p>Anillo de Plástico * 6</p>	 <p>Almohada Desmontable * 1</p>
 <p>Bolsa de Almacenamiento *1</p>	 <p>Espejo * 1</p>	 <p>Manual de Usuario * 1</p>

Instrucciones de Ensamblaje

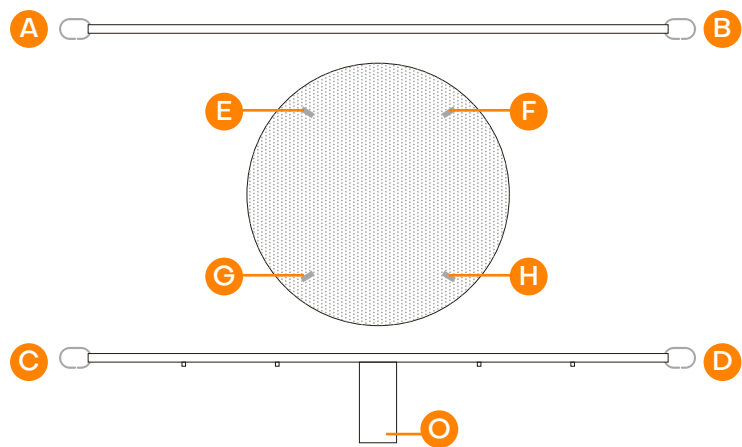

1. Fije el soporte AB con la hebilla de nylon EH y file el soporte CD con la hebilla de nylon FG.

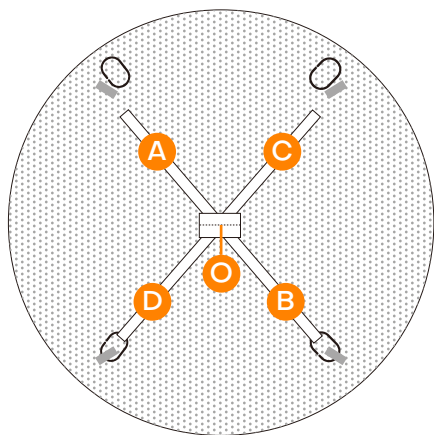

2. Fije el centro de los soportes AB y CD con el Velcro O.
(Consejos cálidos: ponga el AB del soporte debajo del CD del soporte.)

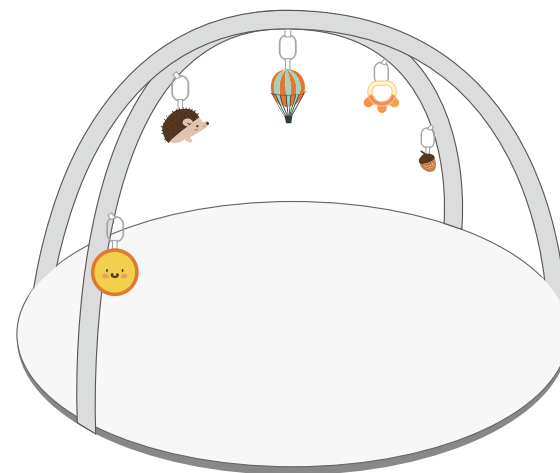

3. Cuelgue los juguetes con el anillo de plástico en el lazo de tela debajo de los soportes.

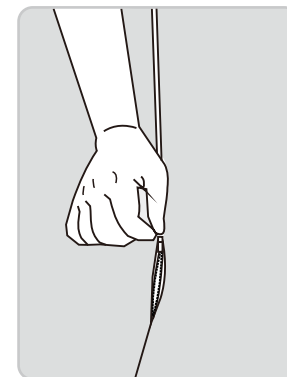

4. Si necesita reemplazar la cubierta, abra la cremallera, coloque el cojín interior en la otra cubierta y ciérrala.

⚠ MISE EN GARDE:

1. ATTENTION: Les arceaux sont sous tension. Attrapez fermement les deux extrémités et faites attention en les retirant afin d'éviter de vous blesser.
2. IMPORTANT: Retirez la totalité de l'emballage et des fixations avant de donner le produit à un enfant. Conservez cet emballage pour toute future consultation. Il contient d'importantes informations. L'assemblage requiert un adulte pour être réalisé. Pour usage familial uniquement.
3. INSTRUCTIONS DE NETTOYAGE: Laver en machine à l'eau froide et en cycle délicat. Ne pas blanchir. Sécher à l'air libre. Nettoyer les jouets avec un chiffon humide et un savon doux avant utilisation. Sécher à l'air libre. Ne pas immerger. Ne pas nettoyer le coussin intérieur.
4. La présence d'adulte est requise pendant l'utilisation, ne pas laisser les bébés sans surveillance.
5. Ce jouet n'est pas destiné à être mis en bouche par le bébé et doit être placé hors de portée de son visage et de sa bouche.
6. Fixez toujours fermement toutes les attaches fournies (ficelles, sangles, pinces, etc.) à un parc pour enfants, conformément aux instructions. Vérifiez fréquemment.
7. Ne pas ajouter de ficelles ou de sangles supplémentaires pour fixer le parc.

Liste des Pièces

		
Housse de Matelas * 2	Coussin Interne * 1	
		
Support * 2		
		
Jouet à Suspandre * 4	Anneau en Plastique * 6	Oreiller Amovible * 1
		
Sac de Rangement * 1	Miroir * 1	Manuel d'Utilisation * 1

Étapes d'Assemblage

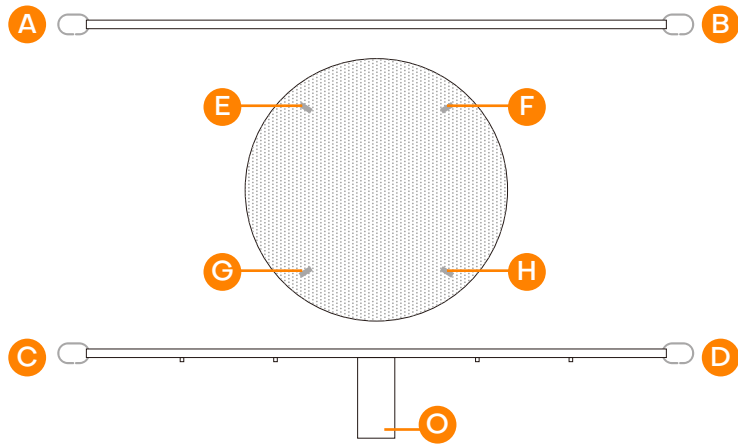

1. Attachez le support AB aux boucles en Nylon EH, puis le support CD aux boucles FG.

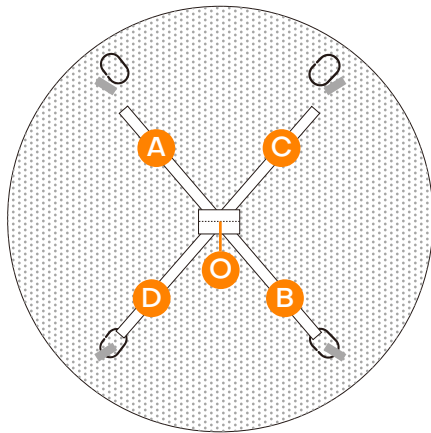

2. Attachez les centres des supports AB et CD grâce au Velcro O.
(Conseils chauds: Mettez le support AB sous le support CD.)

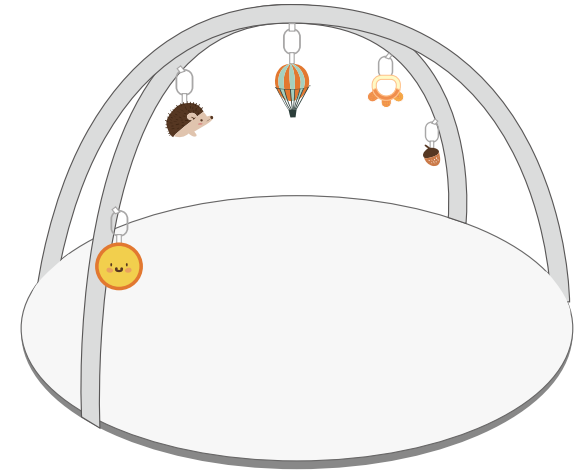

3. Suspendez les jouets avec l'anneau en plastique à la boucle en tissu sous les supports.

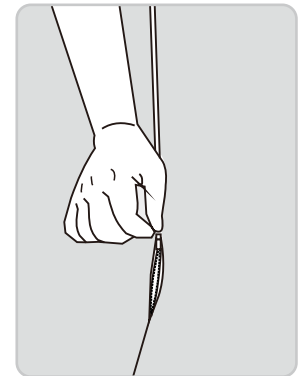

4. Si vous devez remplacer la housse du tapis, vous pouvez la dézipper, placer le coussin interne dans l'autre housse et la rezipper.

besrey[®]

Official Website: www.besrey.com

Email: support@besrey.com

Manufacture: FUJIAN BESREY BABY PRODUCTS CO., LTD.

Address: Stiger Industry Zone, Rongqiao High-Tech, Fuqing City, Fujian Province, China

Product Name: Baby Play Mat

Model Number: BR-WJ001

Importer: STIGER INC.

Address: 1370 Valley Vista Dr Ste 200-208 Diamond Bar, California 91765-0208,
United States Of America

MADE IN CHINA

