

THE CLOUD CHANDELIER - XL - LARGE

FIGURE 1

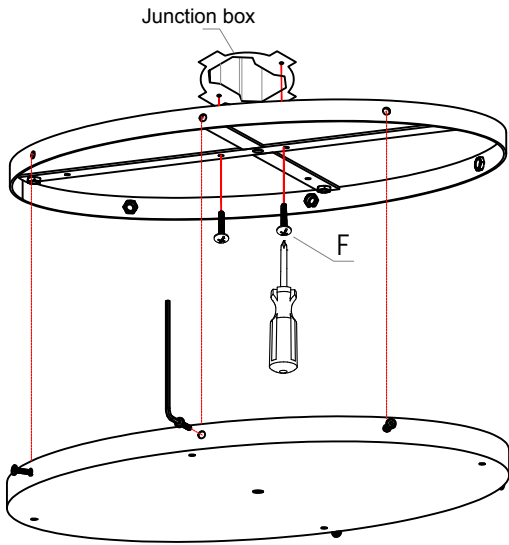

ASSEMBLY INSTRUCTIONS

1. Attach the hanger bar to the junction box in the ceiling using the 2 Philips head bolts (F) provided, see figure 1. Make sure your junction box can hold 30kg in weight. FIGURE 1.
2. Insert the canopy into the hanger bar, then fix it by installing the Allen bolts (E).
3. Attach the fixture loops (D) into the hole at the bottom of the canopy, then connect the chains of the lamp to the fixture loops by using the quick link (H) provided, as per illustrated in FIGURE...







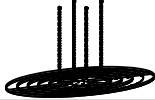
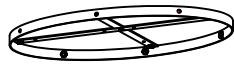
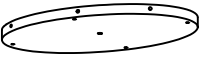

A		CHANDELIER	
B		HANGER BAR	
C		CANOPY	
D		FIXTURE LOOP	
E		BOLT	
F		PHILLIPS BOLT	
G		CHAIN	
H		QUICK LINK (4PCS)	
I		XLARGE GLASS DECO Dia.240mm	79 PCS
J		LARGE GLASS DECO Dia.170mm	77 PCS
K		MEDIUM GLASS DECO Dia.150mm	48 PCS

FIGURE 1



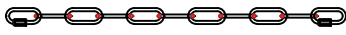

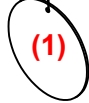
On the hanger frames have the pre-attached deco hanger chain designed for the glass deco hanging. Hang the glass deco on each hanger chain, as per illustrated in FIGURE 1.

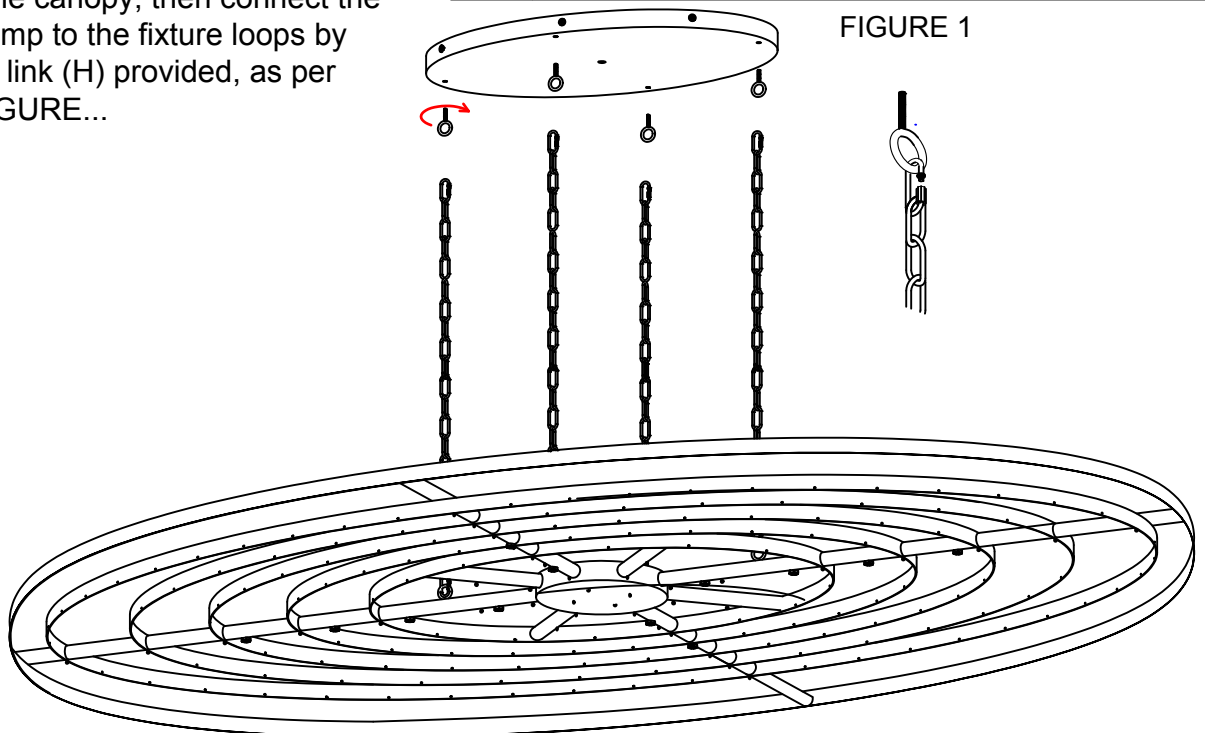
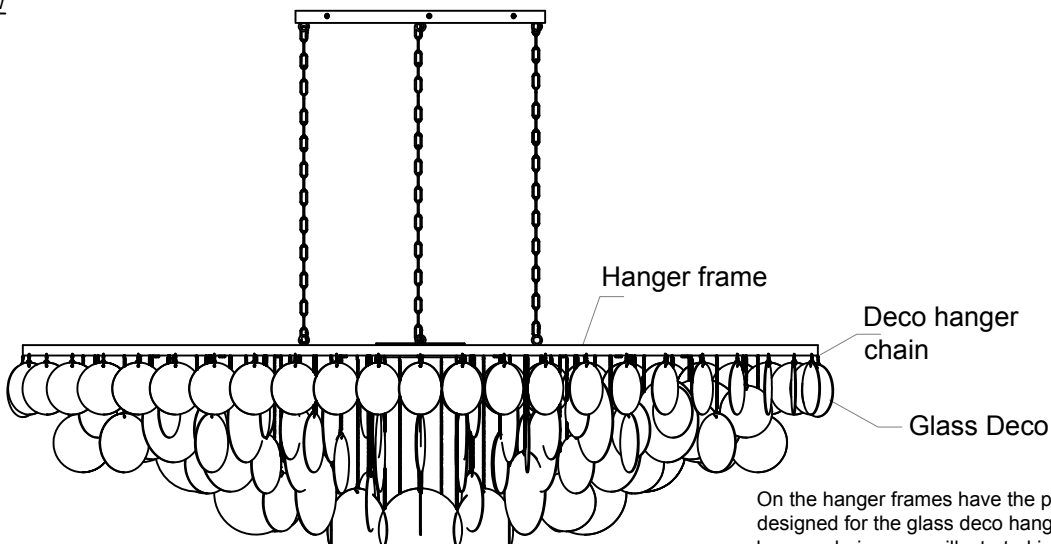
NOTE: There are 3 sizes of glass deco. Make sure each piece will be hook on correct position. Refer FIGURE 2

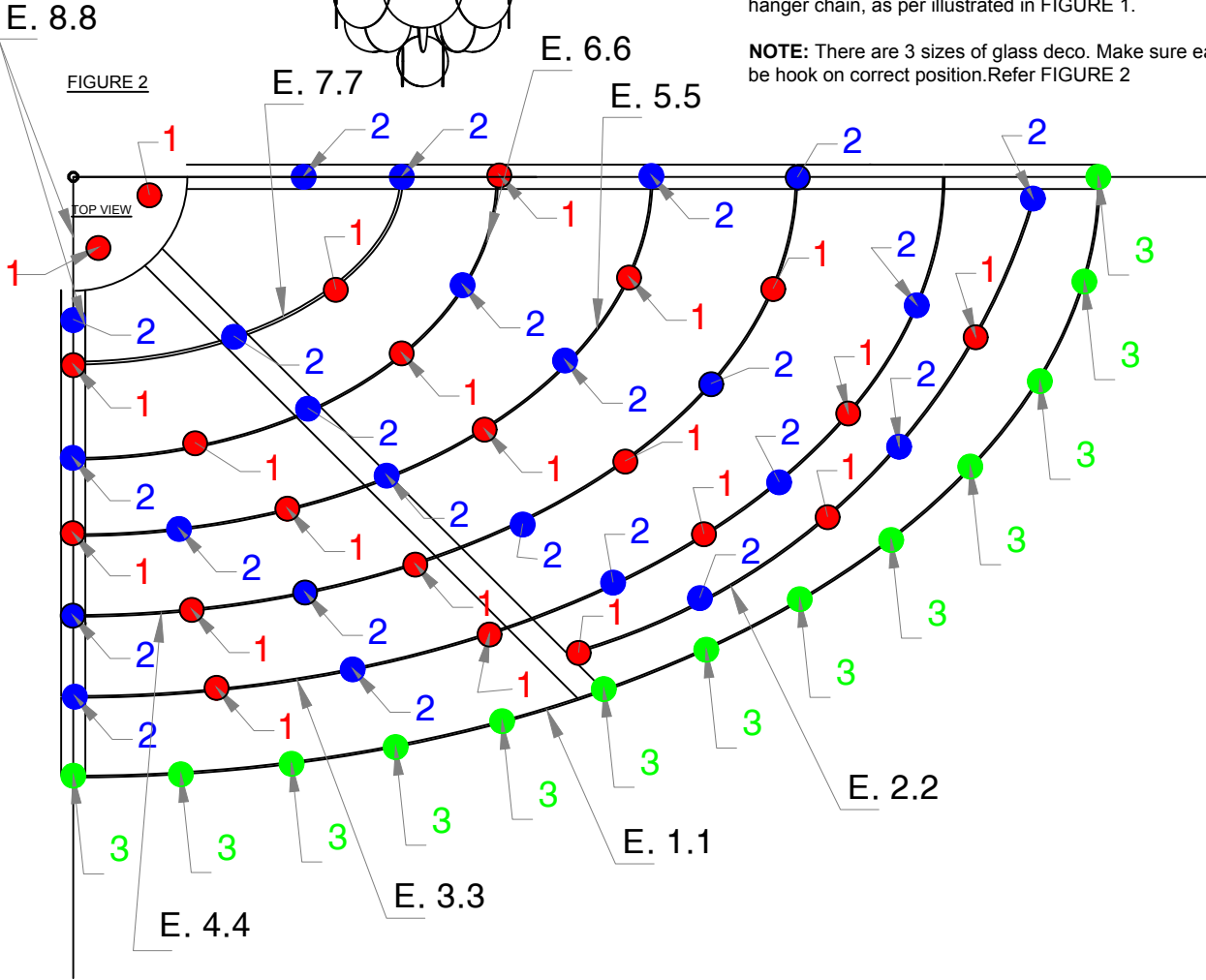

E. 1.1: + All glass (3): 48pcs have no chain only hook

E. 2.2: + All glass (1): 12pcs have no chain only hook
+ All glass (2): 10pcs have the same length of chain: 55mm

E. 3.3: + All glass (2): 17pcs have the same length of chain: 102mm
+ All glass (1): 17pcs have the same length of chain: 38mm

E. 4.4: + All glass (2): 16pcs have the same length of chain: 114mm
+ All glass (1): 16pcs have the same length of chain: 191mm

E. 5.5: + All glass (1): 14pcs have the same length of chain: 254mm
+ All glass (2): 14pcs have the same length of chain: 324mm

E. 6.6: + All glass (2): 10pcs have the same length of chain: 419mm
+ All glass (1): 10pcs have the same length of chain: 349mm

E. 7.7: + All glass (1): 6pcs have the same length of chain: 451mm
+ All glass (2): 6pcs have the same length of chain: 521mm

E. 8.8: + All glass (2): 4pcs have the same length of chain: 635mm
+ All glass (1): 4pcs have the same length of chain: 610mm

After assembling the glasses , be sure match with the attached photo

