



N E L L C O T E
S T U D I O
www.NellcoteStudio.com

NATURAL OAK PENDANT-SMALL



IMPORTANT SAFETY INSTRUCTIONS:

- Consult certified electrician before installation that familiar with commercial type of applications.
- To reduce risk of fire, use 12-watt Compact Fluorescent lamp and do not exceed the recommended wattage.
- The manufacturer and distributor accepts no liability for incorrect installation.
- The ceiling must have at least the capacity of 5 times the weight of the ceiling light. For this light at least a ceiling capacity of 30 kg is required.
- Maximum Supply Current 1 A

WARNING

- Turn-off electricity supply at main circuit panel before installing. All wires are connected. Do not remove the ceiling light from its packaging by pulling on the power cord, as a bad connection may result.
- To reduce the risk of fire, electrical shock, or personal injury, always turn off the ceiling light and allow it to cool prior to replacing light bulb. Do not touch bulb when fixture is turned on or look directly at light bulb. Keep flammable materials away from light bulb.
- Deviation from instructions may result in a risk of fire or electric shock.
- Suitable for indoor use only.
- The external flexible cable or cord of this luminaire cannot be replaced; if the cord is damaged, the luminaire shall be destroyed.
- Terminal block not included. Installation may require advice from a qualified person.

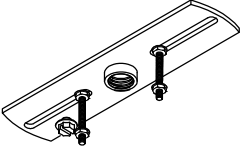
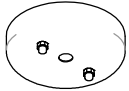
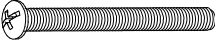
SCREW TERMINAL BLOCK - Connect the cable of the luminaire with the screw terminal block approved in according with IEC/EN 60998-2-1 with minimal rated voltage 250-3 x 2,5 mm² at supply cable.

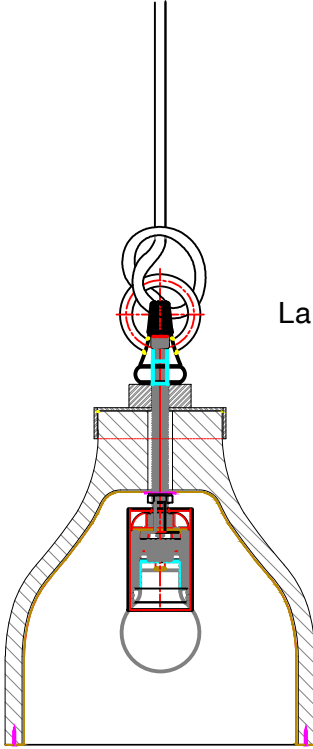
A	 <p>CROSS BAR</p>
B	 <p>CANOPY</p>
C	 <p>PHILLIPS HEAD BOLT</p>
D	 <p>MOUNTING NUTS</p>
E	 <p>Lamp</p>

STEP #1

- Open the parts bag and place all on a flat surface.
- Remove the Lamp body and lay on a flat surface.
- Remove the mounting nuts and the cord grip to separate the cross bar from the Canopy.

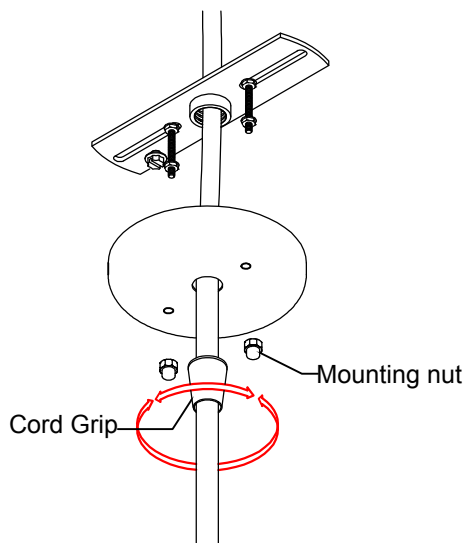

STEP #2

- Attach the cross bar to the junction box by using the Phillips head bolts.
- Set the Lamp near the ceiling surface and connect the wiring fixture into the junction box.

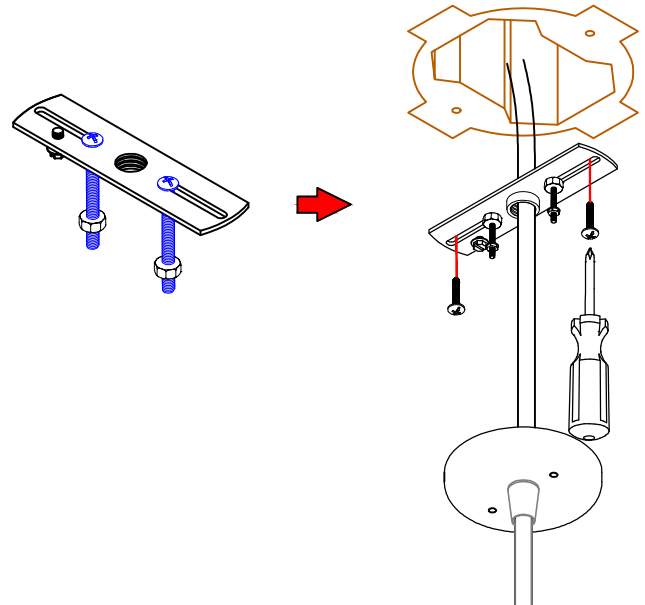

STEP #3

- Move the canopy against the ceiling surface then align and insert the screw of the cross bar into the holes of the canopy.
- Once the canopy is set then fasten the mounting nuts and the cord grip provided.

