



N E L L C O T E

S T U D I O
www.NellcoteStudio.com

BOHO CHANDELIERS

PARTS ENCLOSED

ITEMS	DIAGRAM	DESCRIPTION	QTY.
(A)		Junction Box (not included)	1
(B)		Ceiling Hook (not included)	1
(C)		Mounting Screws	1 set
(D) & (E)		Hang Straight & Collars	1 set
(F)		Canopy	1
(G)		Ring Stopper	1
(H)		Wire Nut (not included)	3

IMPORTANT SAFETY INSTRUCTIONS

1. Use an authorized and certified electrician for consultation and installation.
2. This fixture has been rated for 6 x 25-wat maximum E12 standard bulb.
3. To avoid the risk of fire, do not exceed recommended wattage.
4. The ceiling must have at least the capacity of 5 times the weight of the ceiling light. For this light at least a ceiling capacity of 30 kg is required.
5. The manufacturer and distributor accepts no liability for incorrect installation.
6. For indoor use only.

WARNING

1. Turn-off electricity supply at main circuit panel before installing. Do not connect electricity supply until your ceiling light is fully assembled and installed.
2. All wire are connected. Do not remove the ceiling light from its packaging by pulling on the power cord, as a bad connection may result.
3. To reduce the risk of fire, electrical shock, or personal injury, always turn off the ceiling light and allow it to cool prior to replacing light bulb. Do not touch bulb when fixture is turned on or look directly at light bulb. Keep flammable materials away from light bulb.
4. Deviation from instructions may result in a risk of fire or electric shock.

ASSEMBLY INSTRUCTIONS

1. Turn OFF power to the junction box where the ceiling light will be installed.
2. Remove one of collars (E) from the hang straight (D) by turning it counter-clockwise manually. Insert the hang straight (D) through the canopy (F) and the ring stopper (G) then re-attach the collar (E) to the hang straight (D). Please take a note that the hang straight is included a round tube and a all-threaded bolt inside.
3. Attach the ceiling hook (B) to the ceiling with mounting screws (C).
4. Hang the collar (E) on the ceiling hook (B).
5. * Connect the ground wire from the fixture to the ground junction box wire (Usually the green or base wire).
* Connect the hot wire to the hot junction box wire (Usually black or smooth).
* Connect the neutral wire to the neutral junction box wire (Usually white or ribbed).
* Wrap all the connections with the plastic wire nuts (H) or electric tape.
6. Move the canopy (F) together with the ring stopper (G) up to the ceiling then fasten the pre-attached bolt on the ring stopper (G) to keep the canopy (F) in place.

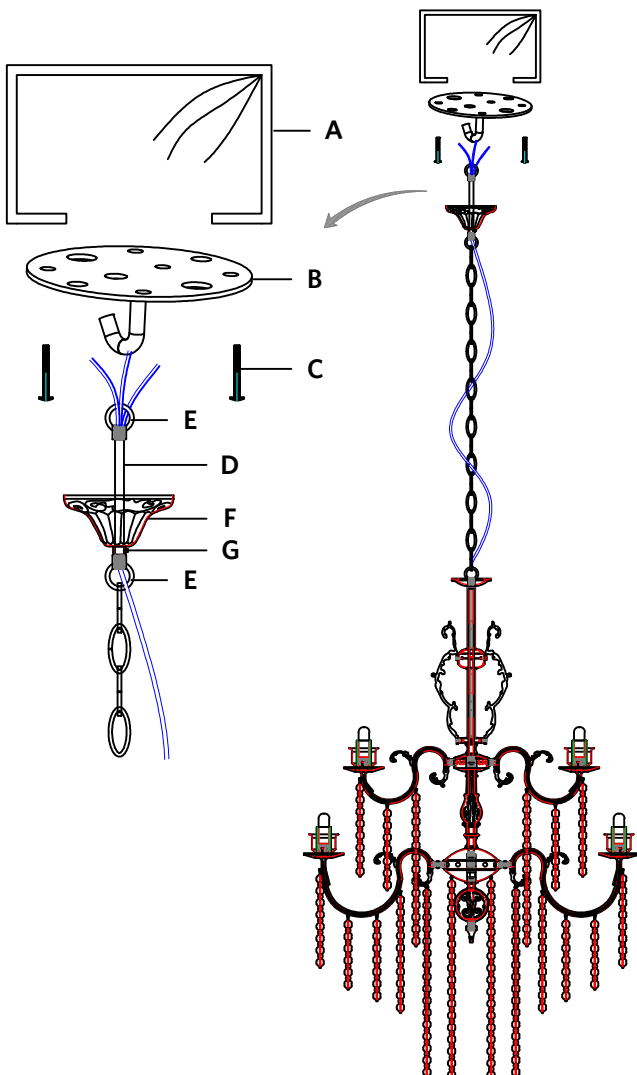









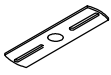

N E L L C O T E

S T U D I O
www.NellcoteStudio.com

BOHO CHANDELIERS

PARTS ENCLOSED

ITEMS	DIAGRAM	DESCRIPTION	QTY.
(A)		Cross Bar	1
(B)		Black Plastic Cord Protector	1
(C)		Hex Nut	1
(D)		Spring Washer	1
(E) & (F)		Hang Straight & Collars	1 set
(G)		Canopy	1
(H)		Ring Stopper	1
(I)		Wire Nut (not included)	3
(J)		Mounting Screws	2

NOTE

IF YOU DON'T HAVE A CEILING HOOK TO HANG THIS CHANDELIER PLEASE USE THE CROSS BAR SET (INCLUDED) AND FOLLOW THE INSTRUCTION BELOW

ASSEMBLY INSTRUCTIONS

1. Turn OFF power to the junction box where the ceiling light will be installed.
2. Remove upper collar (F) from the hang straight (E) by turning it counter-clockwise manually. Insert the hang straight (E) through the canopy (G) and the ring stopper (H).
* Please take a note that the hang straight is included a round tube and a all-threaded bolt inside.
3. Attach the cross bar (A) to the threaded bolt of the hang straight (E) by turning it manually.
4. From the top side of the cross bar (A) install the black plastic cord protector (B) together with the hex nut (C) and the spring washer (D) to the threaded bolt of the hang straight (E). See sketch.
5. Attach the cross bar (A) to the junction box in the ceiling by using two mounting screws (J) provided.
6. * Connect the ground wire from the fixture to the ground junction box wire (Usually the green or base wire).
* Connect the hot wire to the hot junction box wire (Usually black or smooth).
* Connect the neutral wire to the neutral junction box wire (Usually white or ribbed).
* Wrap all the connections with the plastic wire nuts (I) or electric tape.
7. Move the canopy (G) together with the ring stopper (H) up to the ceiling then fasten the pre-attached bolt on the ring stopper (H) to keep the canopy (G) in place.

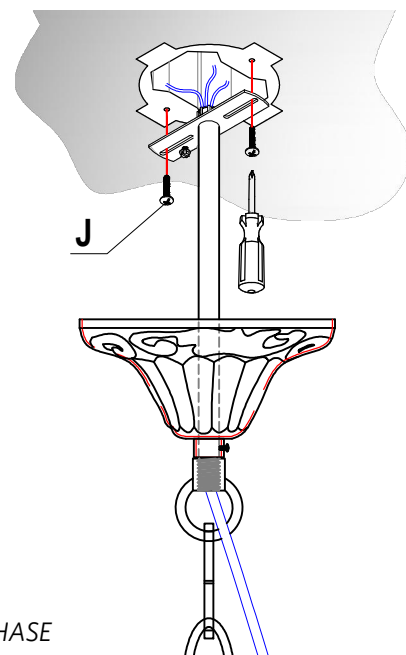
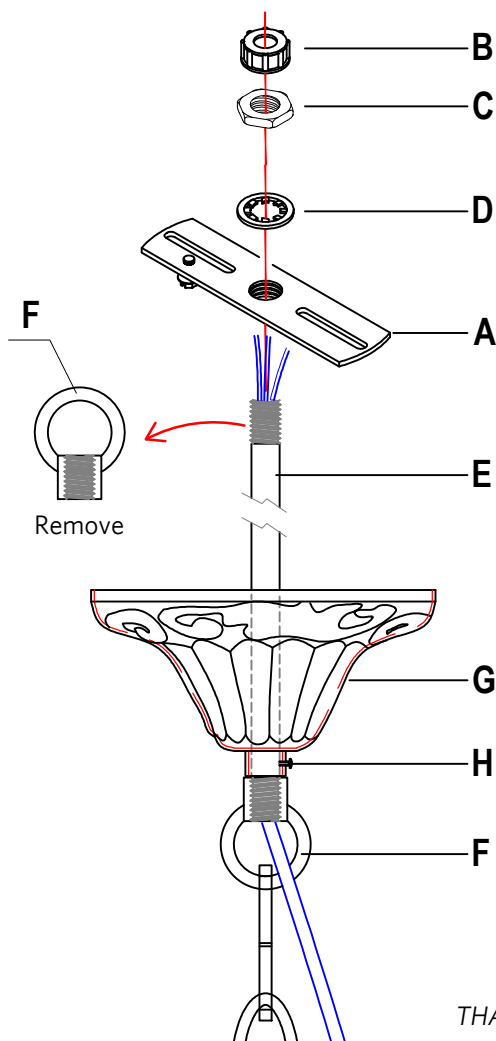

THANK YOU FOR YOUR PURCHASE
www.resourcedecor.com