

Crankcase Breather Filter Kit

*2004.5-2010 GM 6.6L Duramax
(LLY 114025405) (LBZ 114025000) (LMM 114027500)*

Installation Guide



This Install Guide covers all three versions of the PPE Crankcase Breather Filter Kit. The installation process is similar. Some procedures shown may represent a different kit than you have. Refer to your model's Contents when referencing the part being installed.

Thank you for purchasing the PPE Crankcase Breather Kit for your truck.

Team PPE

Contents: 114025405 2004.5-2005 LLY



- 1 - (1) 17.5" x 5/8" Oil Hose
- 2 - (1) 7" x 5/8" Oil Hose
- 3 - (1) 24" x 1/2" Oil Drain-Back Hose
- 4 - (1) 13" x 1" Oil Hose
- 5 - (1) 35" x 1" Oil Hose
- 6 - (1) 22" x 1" Oil Hose
- 7 - (2) Bolts – 8m x 25mm
(2) M8 nyloc lock Nuts
(4) 5/16" grade 8 W
- 8 - (1) 8 x 40mm M8 Spacer Hardware

- 9 - (6) 1" Hose Clamps
- 10 - (1) Breather Filter
- 11 - (1) T-fitting
- 12 - (2) 1/2" Hose Clamps
- 13 - (4) 27mm/13 Hose Clamps
- 14 - (2) Crankcase Breather Fittings
- 15 - (1) Mounting Bracket (shape may vary)
- 16 - (1) Connector Tube
- 17 - (1) 6" Heat Shield for 5/8" Hose

Contents: 114025000 2006-2007 (LBZ)



- 1 - (1) 17.5" x 5/8" Oil Hose
- 2 - (1) 7" x 5/8" Oil Hose
- 3 - (1) 24" x 1/2" Oil Drain-Back Hose
- 4 - (1) 13" x 1" Oil Hose
- 5 - (1) 35" x 1" Oil Hose
- 6 - (1) 22" x 1" Oil Hose
- 7 - (2) Bolts – 8m x 25mm
(2) M8 nyloc lock Nuts
(4) 5/16" grade 8 W
- 8 - (1) 8 x 40mm M8 Spacer Hardware

- 9 - (6) 1" Hose Clamps
- 10 - (1) Breather Filter
- 11 - (1) T-fitting
- 12 - (2) 1/2" Hose Clamps
- 13 - (4) 27mm/13 Hose Clamps
- 14 - (2) Crankcase Breather Fittings
- 15 - (1) Mounting Bracket (shape may vary)
- 16 - (1) Connector Tube
- 17 - (1) 6" Heat Shield for 5/8" Hose

Contents: 114027500 2007.5-2010 LMM



- 1 - (1) 17.5" x 5/8" Oil Hose
- 2 - (1) 7" x 5/8" Oil Hose
- 3 - (1) 24" x 1/2" Oil Drain-Back Hose
- 4 - (1) 13" x 1" Oil Hose
- 5 - (1) 35" x 1" Oil Hose
- 6 - (1) 22" x 1" Oil Hose
- 7 - (2) Bolts – 8m x 25mm
(2) M8 nyloc lock Nuts
(4) 5/16" grade 8 W
- 8 - (2) M6 x 15mm bolts/Nylock Nuts

- 9 - (6) 1" Hose Clamps
- 10 - (1) Breather Filter
- 11 - (1) T-fitting
- 12 - (2) 1/2" Hose Clamps
- 13 - (4) 27mm/13 Hose Clamps
- 14 - (2) Crankcase Breather Fittings
- 15 - (1) Mounting Bracket (shape may vary)
- 16 - (1) Connector Tube
- 17 - (1) 6" Heat Shield for 5/8" Hose



Installation: *NOTE: Engine should be off and cool before beginning*

STEP 1

Loosen lower hose clamp and Remove Airbox Resonator.

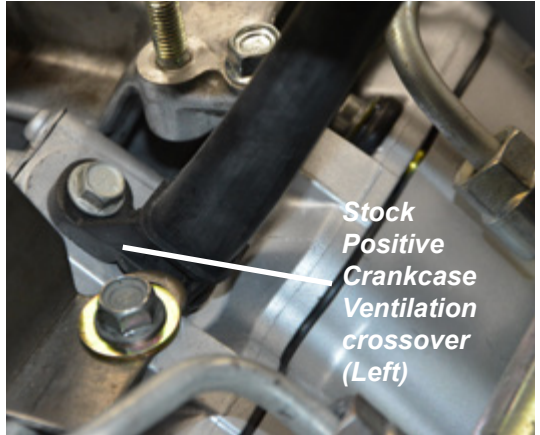

STEP 2

Using 10mm socket with long extension and wrench, remove the stock Positive Crankcase Ventilation crossover tube from each side of the heads. Then remove the OEM clamp connecting the PCV crossover tube to the turbo inlet.

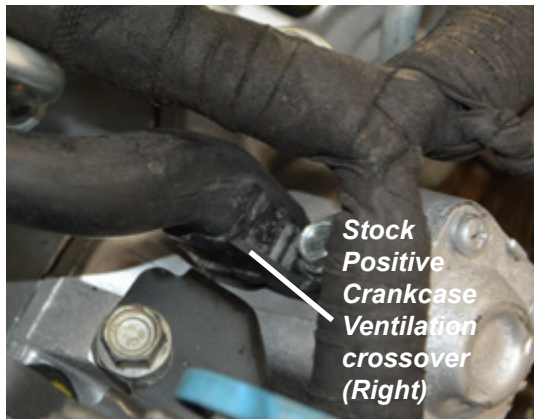
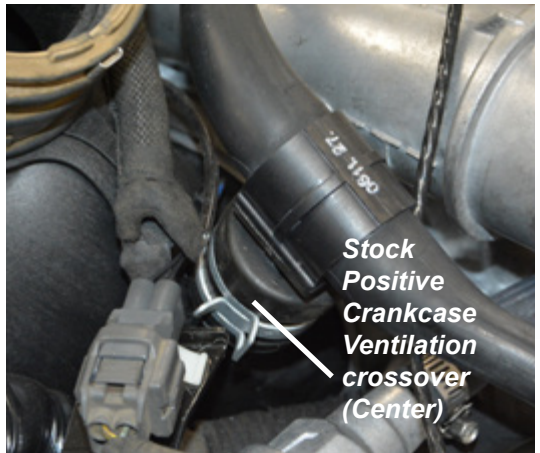

Assemble as shown.

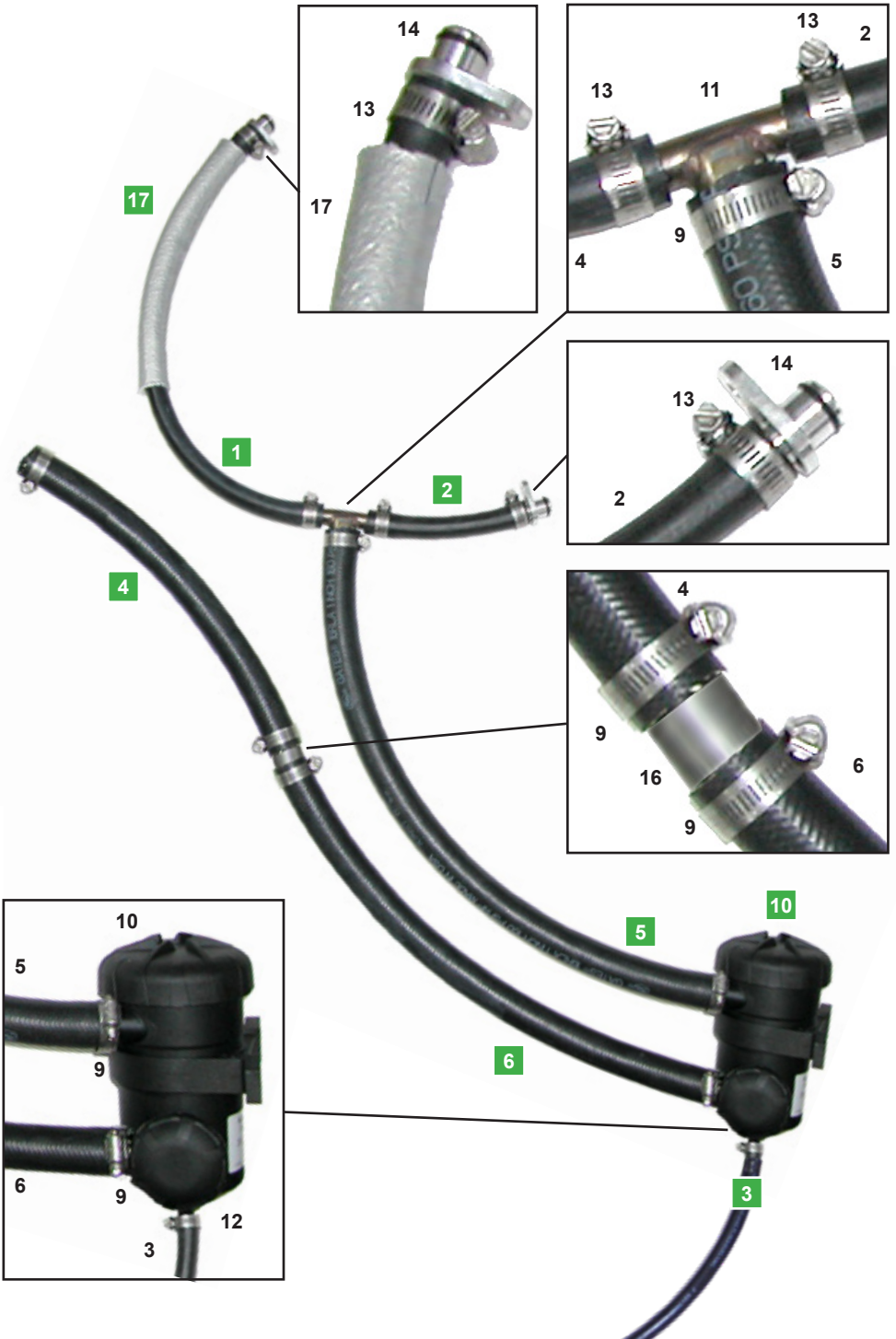



STEP 3

Assemble the 5/8" hose and billet breather adaptors to the stainless steel 1" adaptor supplied with the kit.

STEP 4 A/B

Install the assembled breather lines in the original PCV valve holes, use silicone lube or grease to lubricate the O-rings on the billet adaptors.

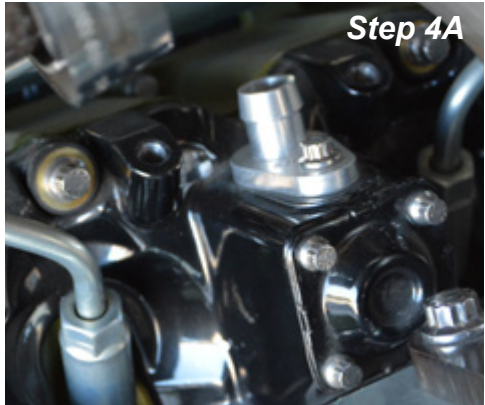

STEP 5

Tighten down using the OEM bolts to 9 ft-lbs.

STEP 6

Bolt breather to breather bracket using supplied hardware.



STEP 7

Remove OEM bolt.

STEP 8

(examples on the next page)
Mount filter on vehicle with supplied hardware.

STEP 9

Connect 1" hose from PCV lines to inlet of filter.

STEP 10

Connect 1" hose from discharge of filter to turbo inlet.

Mounted: 114025405 2004.5-2005 LLY

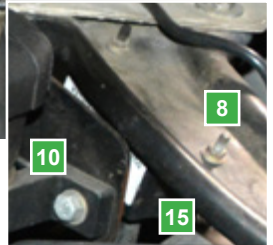

Assemble Mounting Bracket (15), M6 x 15mm bolt/Nylock Nut assembly (8) and Breather Filter (10) then mount in location shown.

Mounted: 114025000 2006-2007 (LBZ)

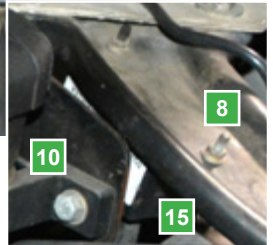

Assemble Mounting Bracket (15), M6 x 15mm bolt/Nylock Nut assembly (8) and Breather Filter (10) then mount in location shown.

Mounted: 114027500 2007.5-2010 LMM

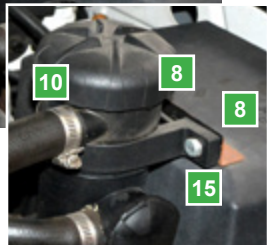

Assemble Mounting Bracket (15), M6 x 15mm bolt/Nylock Nut assembly (8) and Breather Filter (10) then mount in location shown.

Note:

It is recommended to install a PPE Check Valve (114025010) inline of 24" x 1/2" Oil Drain-Back Hose (3) and plumb into the upper oil pan.

If no Check Valve is used, the 24" x 1/2" Oil Drain-Back Hose (3) must be plugged.



PPE Check Valve (114025010)

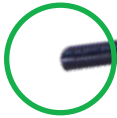



DISCLAIMER OF LIABILITY

Performance products can increase horsepower above and beyond factory specifications. Additional horsepower creates more stress on the drive-train components, which could result in drive-train failure.

Note regarding emissions-related, non-E.O.-legal products: THESE PRODUCTS ARE LEGAL IN CALIFORNIA ONLY FOR RACING VEHICLES THAT MAY NEVER BE USED, OR REGISTERED OR LICENSED FOR HIGHWAY OR OFF-ROAD USE.

This agreement sets forth the terms and conditions for the use of PPE products. The installation of this product indicates that the Buyer has read and understands this agreement and accepts the terms and conditions. PPE (Pacific Performance Engineering) Inc., its distributors, employees, and dealers (the "Seller") shall not be responsible for the product's proper use and service. The buyer hereby waives all liability claims. The Buyer hereby acknowledges no reliance on the Seller's skill or judgment to select or furnish goods suitable for any particular purpose and that there are no liabilities which extend beyond the description on the face hereof, and the Buyer hereby waives all remedies or liabilities expressed or implied, arising by law or otherwise (including without any obligation of the Seller with respect to fitness, merchantability and consequential damages), or whether or not occasioned by the Seller's negligence. The Seller disclaims any warranty and expressly disclaims any liability for personal injury or damages. The Buyer acknowledges and agrees that the disclaimer of any liability for personal injury is a material term for this agreement and the Buyer agrees to indemnify the Seller and to hold the Seller harmless from any claim related to the item of equipment purchased. Under no circumstances will the Seller be liable for any damages or expenses by reason of use or sale of any such equipment. The Seller assumes no liability regarding the improper installation or misapplication of its products. It is the installer's responsibility to check for proper installation and if in doubt, contact the manufacturer. The Buyer is solely responsible for all warranty issues from the manufacturer.

LIMITATION OF WARRANTY

The Seller gives Limited Warranty as to description, quality, merchantability, and fitness for a particular purpose, productiveness, or any other matter of Seller's product sold herewith. The Seller shall not be responsible for the products proper use and service and the Buyer hereby waives all rights other than those expressly written herein. This warranty shall not be extended, altered or varied except by a written instrument signed by Seller and Buyer.

Limited lifetime warranty on all PPE cast aluminum products, and PPE Transmission Coolers. Three (3) year limited warranty on PPE Manifolds and Up-Pipes Kits, and OEM-Length Up-Pipes. One (1) year limited warranty on all other PPE products from the date of sale to original buyer and limited solely to the parts contained within the products kit. All products that are in question of Warranty must be returned prepaid to the Seller and must be accompanied by a dated proof of purchase receipt. All Warranty claims are subject to approval by Seller. Under no circumstances will the Seller be liable for any labor charged or travel time incurred in diagnosis for defects, removal, or re-installation - of this product or any other contingent expenses. Under no circumstances will the Seller be liable for any damage or expenses incurred by reason of the use or sale of any such equipment. In the event that the buyer does not agree with this agreement: the buyer may promptly return this product, in a new and unused condition in its original packaging, with a dated proof of purchase to the place of purchase within ten (10) days from date of purchase for a full refund. The installation of this product indicates that the buyer has read and understands this agreement and accepts its terms and conditions.



PACIFIC PERFORMANCE ENGINEERING

PPEpower.com