

A New Standard of Innovation

InBody 970



A New Standard of Innovation

InBody is continuously evolving the way body composition is measured and expanding the application in various fields.

With the mission to deliver the utmost reliable and innovative body composition analysis, now InBody introduces the next generation of body composition analyzer, InBody970.

The InBody970 is equipped with state-of-the-art 3MHz technology and new ergonomic design to better suit diverse patients with different conditions and medical specialties than ever before.





Innovative Design

InBody's Accurate 3MHz Measurement Technology

7 Different Result Sheets for In-depth Analysis

Smart InBody Measurement

InBody970

InBody970 Highlights

Innovative Design

The InBody970 delivers a new seamless look with the premise of detail. The concave head design protects the privacy of the subject during measurement while also enhancing user's visibility. Stainless electrodes and enhanced footplate improve conductivity and allow weight measurements up to 300kg.

InBody's Accurate 3MHz Measurement Technology

As the frequency increases, it becomes more difficult to control in the human body, possibly resulting in irregular impedance measurements. InBody technology has overcome this limitation and achieved the feat of controlling 3MHz frequency. The 3MHz frequency is able to penetrate the human cell membranes more effectively and therefore better reflects Intracellular Water in comparison to lower frequencies. This then enables us to differentiate between the Intracellular Water and the Extracellular Water, resulting in a more accurate measurement of Total Body Water.

7 Different Result Sheets for In-depth Analysis

- Evaluation Result Sheet can be used to evaluate and compare body composition results by age.
- Research Result Sheet incorporates frequently used parameters and provides segmental graphs that offer a more comprehensive analysis.
- Comparison Result Sheet provides a Cole-Cole plot graph along with other significant parameters to compare previous and current results.
- Visceral Fat Result Sheet can be used to monitor changes in subcutaneous and visceral fat.
- * Body Composition Result Sheet, Body Composition Result Sheet for Children, Body Water Result Sheet are also available.

Smart InBody Measurement

The ID recognition process can be performed quickly and with ease by using the InBody BAND, Fingerprint, or Barcode scanner.



InBody Technology



Body Composition Evaluation by Age Based on InBody Big Data

InBody provides age-specific graphs for each body composition analysis parameter based on globally accumulated InBody Data. With this, a comprehensive analysis is provided so that you can compare your data to the data of the young age group (T-score) and the same age group (Z-score).

Multi-Frequency for In-Depth Analysis

Low frequencies do not pass through the cell membranes well so they mainly reflect ECW, while high frequencies pass through the cell membranes and therefore reflect both ECW and ICW.

By using multi-frequencies, InBody measures ECW and ICW separately and measures TBW accurately to check the water balance. As the newest technological advancement, InBody utilizes the 3MHz frequency, the 3MHz frequency, which enables the precise measurement of a more diverse range of patients and subjects with special body compositions. Furthermore, the technology that enabled the utilization of 3MHz also ensures the measurement stability from other frequencies even when there are outside interferences.

* ECW: Extracellular Water, ICW: Intracellular Water, TBW: Total Body Water

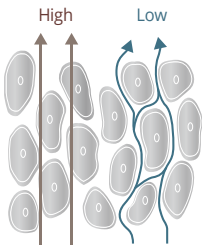

High Reproducibility Assured by 8-Point Tactile Electrodes

InBody placed a total of eight electrodes- one current and one voltage electrode on each handle and footplate. With this electrode design, it maintains the measurement starting point at all times. Even if the measurement postures are changed or multiple measurements are made, it is able to maintain high reproducibility.

Multi-frequency Reactance Data for Enhanced Clinical Use

Reactance is a resistance that occurs in cell membranes, which is related to the cellular health such as somatic cell mass, structural integrity, and physiological functional level of the cell. Besides 50kHz, InBody improved segmental reactance measurement technology in 5kHz, 250kHz as well. Through this, InBody provides more parameters which can be used in various clinical fields to pre-screen diseases and evaluate nutritional status.

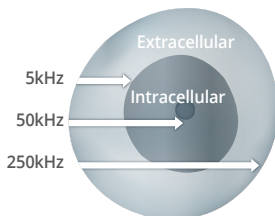

Direct Segmental Measurement-BIA

Each of our body segments is different in length and cross-sectional area. Arms and legs are longer and narrower in comparison to the trunk, so their impedance values are higher than the trunk. On the other hand, the trunk is shorter and wider than the arms and legs, so its impedance value is lower. However, the trunk muscle mass accounts for almost half of the whole body muscle mass, which is why a small impedance change in the trunk has a greater impact on the amount of whole body muscle mass. Therefore, the trunk must be measured separately in order to measure the whole body muscle mass accurately.

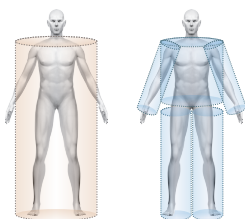

No Estimations or Empirical Equations

In the past, the conventional BIA devices used empirical estimations to compensate technological limitations of whole body measurement and use of single low frequency. To calculate the body composition by these conventional BIA devices, they needed to add statistical data such as age and gender in order to calculate results. However, InBody overcame these limitations with technologies of using Multi-Frequency, Direct Segmental Measurement, and 8-Point Tactile Electrodes System so that InBody provides results that are not affected by age, ethnicity or gender. Only reference ranges or scores based on age and gender are used as a basis for evaluating the values determined.

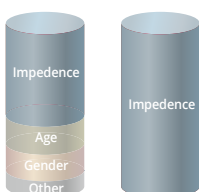

InBody Application



Nutrition

Monitor body composition change for nutritional evaluation.

Kim, H.S., Lee, E.S., Lee, Y.J., Jae Ho Lee, C. T.L., & Cho, Y.J (2015) Clinical Application of Bioelectrical Impedance Analysis and its Phase Angle For Nutritional Assessment of Critically Ill Patients. Journal of the Korean Society for Parenteral and Enteral Nutrition, 7(2), 54-61

Nephrology

Obtain useful insights on dialysis patients' hydration and nutrition status.

Ando, M., Suminaka, T., Shimada, N., Asano, K., Ono, J. I., Jikuya, K., & Mochizuki, S. (2018). Body water balance in hemodialysis patients reflects nutritional, circulatory, and body fluid status. Journal of Biotheology, 32(2), 46-55.

Rehabilitation

Monitor injury and post-surgical recovery.

Yoshimura, Y., Bise, T., Nagano, F., Shimazu, S., Shiraishi, A., Yamaga, M., & Koga, H. (2018). Systemic inflammation in the recovery stage of stroke: its association with sarcopenia and poor functional rehabilitation outcomes. Progress in Rehabilitation Medicine, 3, 20180011.

Professional Sports

Manage body composition to enhance performance and minimize injury risk.

Almăjan-Guță, B., Rusu, A. M., Nagel, A., & Avram, C. (2015). Injury frequency and body composition of elite Romanian rugby players. Timisoara Physical Education and Rehabilitation Journal, 8(15), 17-21.



Geriatric

Monitor muscle mass and muscle imbalance to screen sarcopenia with SMI, which are related to risks of fall and frailty.

Yoshimura, Y., Wakabayashi, H., Bise, T., & Tanoue, M. (2018). Prevalence of sarcopenia and its association with activities of daily living and dysphagia in convalescent rehabilitation ward inpatients. Clinical Nutrition, 37(6), 2022-2028.

Cardiology

Pre-screen the risk factors of cardiovascular disease.

Thomas, E., Gupta, P. P., Fonarow, G. C., & Horwich, T. B. (2019). Bioelectrical impedance analysis of body composition and survival in patients with heart failure. Clinical cardiology, 42(1), 129-135.

Validations of More Than 3,000 Research Papers

Study 1 HIGH ACCURACY AND REPRODUCIBILITY OF FAT FREE MASS & PERCENT BODY FAT MEASUREMENTS COMPARED WITH DEXA

The measurement (mean \pm SD) for FFM with DXA was 52.8 ± 11.0 , and BIA was 53.6 ± 11.0 . Delta (S-MFBIA vs DXA) was 0.8 ± 2.2 (5% limits of agreement -3.5 to $+5.2$), and concordance correlation coefficient (CCC) was 0.98 (95% CI, 0.97–0.98). The measurements (mean \pm SD) for PBF with DXA was $37.5 \pm 10.6\%$ and S-MFBIA was $36.6 \pm 11.3\%$. Delta (S-MFBIA vs DXA) was -0.9 ± 2.6 (5% limits of agreement 6.0 to $+4.2$), and CCC was 0.97 (95% CI, 0.96–0.98).

Hurt, Ryan T., et al. "The Comparison of Segmental Multifrequency Bioelectrical Impedance Analysis and Dual-Energy X-ray Absorptiometry for Estimating Fat Free Mass and Percentage Body Fat in an Ambulatory Population." *Journal of Parenteral and Enteral Nutrition* (2020).

Study 2 HIGH CORRELATION WITH D2O DILUTION METHOD FOR TOTAL BODY WATER

The study concluded that the BIA device InBodyS10 showed good test-retest precision (%CV = 5.2 raw; 1.1 after outlier removal) and high accuracy to D₂O for Total Body Water [TBWD₂O = 0.956 TBWBIA, R²= 0.92, root mean squared error(RMSE) = 2.2kg]. %Fat estimates from DXA, ADP, D₂O, and BIA all showed high correlation with the Lohman model.

Ng, Bennett K., et al. "Validation of rapid 4-component body composition assessment with the use of dual-energy X-ray absorptiometry and bioelectrical impedance analysis." *The American journal of clinical nutrition* 108.4 (2018) :708-715.

Study 3 HIGH ACCURACY WITH COMPUTED TOMOGRAPHY FOR MUSCLE MASS

It was suggested that estimating muscle mass using DXA and BIA(InBody720) is a preferred method for diagnosis of sarcopenia in kidney transplant recipients. Both DXA and InBody showed high correlation with CT.

Yanishi, M., et al. "Dual energy X-ray absorptiometry and bioimpedance analysis are clinically useful for measuring muscle mass in kidney transplant recipients with sarcopenia." *Transplantation proceedings*. Vol.50.No.1.Elsevier, 2018.

Study 4 HIGH CORRELATION OF FAT FREE MASS BETWEEN DEXA AND INBODY970

Total of 150 results were analyzed, excluding duplicate data from the same subject. Fat Free Mass measured by InBody970 had a very high correlation with DEXA of R²=0.983 or higher. (P value < 0.05)

* Internal Validation by InBody

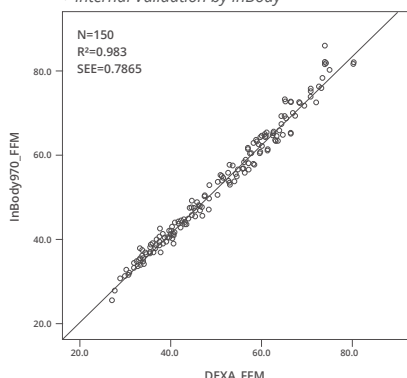

* Total: 150 Male: 74, Female: 76

FFM(kg)	Total	Male	Female
	Mean \pm SD(range)	Mean \pm SD(range)	Mean \pm SD(range)
DEXA	49.09 \pm 12.95(27.2–80.8)	59.49 \pm 9.19(37.6–80.8)	38.97 \pm 6.42(27.2–57.6)
InBody970	50.92 \pm 13.60(25.4–86.0)	61.77 \pm 10.06(38.6–86.0)	40.35 \pm 6.34(25.4–57.7)

Body Composition Result Sheet

InBody

[InBody970] [Yscope]

InBody

www.inbody.com

ID	Height	Age	Gender	Test Date / Time
Jane Doe	156.9cm	51	Female	2021.03.31. 15 : 44

1 Body Composition Analysis

	Values	Total Body Water	Soft Lean Mass	Fat Free Mass	Weight
Total Body Water(L)	27.4 (26.4 ~ 32.2)	27.4	34.9 (33.8 ~ 41.4)	37.1 (35.8 ~ 43.8)	59.1 (43.9 ~ 59.5)
Protein (kg)	7.1 (7.0 ~ 8.6)	non-osseous			
Minerals (kg)	2.64 (2.44 ~ 2.98)				
Body Fat Mass (kg)	22.0 (10.3 ~ 16.5)				

2 Muscle-Fat Analysis

	Under	Normal	Over	
Weight (kg)	55 70 85 100 115 130 145 160 175 190 205 %	59.1		
SMM (kg) Skeletal Muscle Mass	70 80 90 100 110 120 130 140 150 160 170 %	19.5		
Body Fat Mass (kg)	40 60 80 100 160 220 280 340 400 460 520 %	22.0		

3 Obesity Analysis

	Under	Normal	Over	
BMI (kg/m ²) Body Mass Index	10.0 15.0 18.5 22.0 25.0 30.0 35.0 40.0 45.0 50.0 55.0	24.0		
PBF (%) Percent Body Fat	8.0 13.0 18.0 23.0 28.0 33.0 38.0 43.0 48.0 53.0 58.0	37.2		

4 Segmental Lean Analysis

Based on ideal weight Based on current weight

	Under	Normal	Over	ECW Ratio
Right Arm (kg) (%)	55 70 85 100 115 130 145 160 175 %	2.00 101.2		0.378
Left Arm (kg) (%)	55 70 85 100 115 130 145 160 175 %	1.91 97.1		0.378
Trunk (kg) (%)	70 80 90 100 110 120 130 140 150 %	17.7 99.0		0.398
Right Leg (kg) (%)	70 80 90 100 110 120 130 140 150 %	5.24 84.2		0.403
Left Leg (kg) (%)	70 80 90 100 110 120 130 140 150 %	5.15 82.7		0.404

5 ECW Ratio Analysis

	Under	Normal	Over
ECW Ratio	0.320 0.340 0.360 0.380 0.390 0.400 0.410 0.420 0.430 0.440 0.450	0.398	

6 Body Composition History

Weight (kg)	65.3	63.9	62.4	61.8	62.3	60.9	60.5	59.1
SMM (kg) Skeletal Muscle Mass	20.1	20.0	19.7	19.7	19.8	19.7	19.8	19.5
PBF (%) Percent Body Fat	41.3	40.7	39.2	39.0	39.4	38.6	37.7	37.2
ECW Ratio	0.399	0.398	0.396	0.396	0.397	0.396	0.398	0.398
<input checked="" type="checkbox"/> Recent <input type="checkbox"/> Total	20.07.21 15:11	20.08.27 14:58	20.09.20 15:02	20.11.23 15:23	20.12.21 15:00	21.02.19 14:52	21.03.20 15:12	21.03.31 15:44

7 InBody Score

67 / 100 Points

* Total score that reflects the evaluation of body composition. A muscular person may score over 100 points.

8 Visceral Fat Area

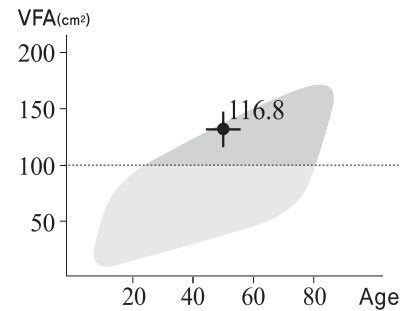

9 Weight Control

Target Weight 51.7 kg
Weight Control -7.4 kg
Fat Control -10.1 kg
Muscle Control +2.7 kg

10 Research Parameters

Intracellular Water 16.5 L (16.3~19.9)
Extracellular Water 10.9 L (10.0~12.2)
Basal Metabolic Rate 1171 kcal (1255~1451)
Waist-Hip Ratio 0.94 (0.75~0.85)
Body Cell Mass 23.6 kg (23.4~28.6)
SMI 5.8 kg/m²

11 Whole Body Phase Angle

ϕ (°) 50 kHz | 4.0°

12 Segmental Body Phase Angle

ϕ (°) 5 kHz	RA	LA	TR	RL	LL
5 kHz	1.7	4.7	1.7	1.6	4.5
50 kHz	4.1	5.7	4.0	3.8	4.3
250 kHz	3.8	5.6	2.9	2.9	2.9

13 Impedance

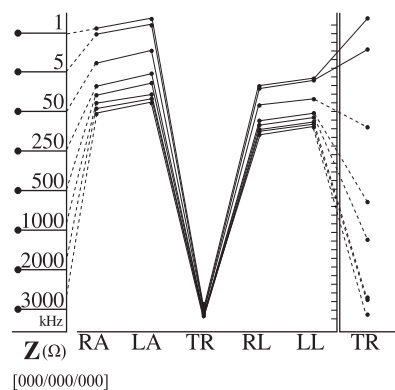

Result Sheet Interpretation

1 Body Composition Analysis

Body weight is the sum of Total Body Water, Protein, Minerals, and Body Fat Mass. Maintain a balanced body composition to stay healthy.

2 Muscle-Fat Analysis

The balance between Skeletal Muscle Mass and Body Fat Mass is a key health indicator. Muscle-Fat Analysis shows this balance by comparing the length of the bars for Weight, Skeletal Muscle Mass, and Body Fat Mass.

3 Obesity Analysis

Accurate obesity analysis cannot be performed using BMI, but the ratio of body fat compared to the weight, which is called the Percent Body Fat, must be assessed. The InBody970 can detect hidden health risks like Sarcopenic Obesity, in which a person appears slim on the outside but has a high percent body fat.

4 Segmental Lean Analysis

Analyzing the lean mass in each segment helps identify imbalances and insufficiently developed lean mass, which can be used to develop targeted exercise programs. The lean mass of the arms, trunk, and legs are represented by two bars. The top bar shows how much lean mass there is in a segment compared to the ideal weight, and the bottom bar shows how sufficient the lean mass is to support your current weight.

5 ECW Ratio Analysis

The extracellular water ratio shows the balance status of body water. The ratio between intra/extracellular water remains constant at about 3:2 ratio in healthy individuals, and when this balance is broken down edema may occur.

6 Body Composition History

Using Body Composition History, you can monitor changes in Weight, Skeletal Muscle Mass, Percent Body Fat, and ECW Ratio. Taking regular InBody Tests and monitoring changes in body composition is a good step toward a healthier life.

7 InBody Score

Unique index created by InBody to make it easier to understand the current body composition status. The standard range is between 70~90 points, and based on the weight control, the point +/- from 80 points.

8 Visceral Fat Area

Visceral Fat Area is the estimated area of the fat surrounding internal organs in the abdomen. Maintain a Visceral Fat Area under 100 cm^2 to minimize the risk of visceral fat related diseases. With Yscope the InBody970 provides more precise abdominal fat analysis by measuring abdominal impedance separately.

9 Weight Control

Weight Control shows the recommended weight, fat, and muscle mass for a healthy body. The '+' means to gain and the '-' means to lose. Use the weight control to set your own goal.

10 Research Parameters

Various research parameters are provided such as Basal Metabolic Rate, Waist-Hip Ratio, Obesity Degree, Skeletal Muscle Mass Index (SMI), Body Cell Mass, and more.

11 Whole Body Phase Angle

Phase Angle is related to the health status of the cell membrane. Strengthening of the cellular membrane and structural function will increase the Phase Angle, while damage or a decrease in function will result in a decrease in the Phase Angle.

12 Segmental Body Phase Angle

Segmental Phase Angle indicates the Phase Angle of each part of the body, representing the level of structural integrity and function of the cell membrane.

13 Impedance

Impedance is the resistance that occurs when weak alternating current is applied to the human body. InBody visualizes the impedance with the graph. You can easily detect if there is reversed impedance error by checking crossed lines in the impedance graph. Below the impedance graph, you can also check the error codes.

Body Water Result Sheet

InBody Body Water [InBody970] [Yscope]

InBody
www.inbody.com

ID	Height	Age	Gender	Test Date / Time
Jane Doe	156.9cm	51	Female	2021.03.31. 15:44

Body Water Composition

	Under	Normal	Over
TBW Total Body Water (L)	40 60 90 100 110 140 160 180 200 220 240 %	27.4	
ICW Intracellular Water (L)	40 60 90 100 110 140 160 180 200 220 240 %	16.5	
ECW Extracellular Water (L)	70 80 90 100 110 120 130 140 150 160 170 %	10.9	

ECW Ratio Analysis

	Under	Normal	Over
ECW Ratio	0.320 0.340 0.360 0.380 0.390 0.400 0.410 0.420 0.430 0.440 0.450	0.398	

Segmental Body Water Analysis

	Under	Normal	Over
Right Arm (L)	40 60 80 100 120 140 160 180 200 220 240 %	1.55	
Left Arm (L)	40 60 80 100 120 140 160 180 200 220 240 %	1.49	
Trunk (L)	70 80 90 100 110 120 130 140 150 160 170 %	13.8	
Right Leg (L)	70 80 90 100 110 120 130 140 150 160 170 %	4.12	
Left Leg (L)	70 80 90 100 110 120 130 140 150 160 170 %	4.05	

Segmental ECW Ratio Analysis

	Right Arm	Left Arm	Trunk	Right Leg	Left Leg
Over					
Slightly Over			0.398	0.403	0.404
Normal	0.378	0.378			

Body Water Composition History

	20.07.21 15:11	20.08.27 14:58	20.09.20 15:02	20.11.23 15:23	20.12.21 15:00	21.02.19 14:52	21.03.20 15:12	21.03.31 15:44
Weight (kg)	65.3	63.9	62.4	61.8	62.3	60.9	60.5	59.1
TBW Total Body Water (L)	28.3	28.0	28.0	27.9	27.9	27.6	27.8	27.4
ICW Intracellular Water (L)	17.0	16.9	16.9	16.8	16.8	16.7	16.7	16.5
ECW Extracellular Water (L)	11.3	11.1	11.1	11.0	11.1	10.9	11.1	10.9
ECW Ratio	0.399	0.398	0.396	0.396	0.397	0.396	0.398	0.398

Recent Total

Body Composition Analysis

Protein	7.1 kg (7.0~8.6)
Minerals	2.64 kg (2.44~2.98)
Body Fat Mass	22.0 kg (10.3~16.5)
Fat Free Mass	37.1 kg (35.8~43.8)
Bone Mineral Content	2.18 kg (2.01~2.45)

Muscle-Fat Analysis

Weight	59.1 kg (43.9~59.5)
Skeletal Muscle Mass	19.5 kg (19.5~23.9)
Soft Lean Mass	34.9 kg (33.8~41.4)
Body Fat Mass	22.0 kg (10.3~16.5)

Whole Body Phase Angle

ϕ (°) 50 kHz | 4.0°

Segmental Body Phase Angle

	RA	LA	TR	RL	LL
ϕ (°) 5 kHz	1.7	4.7	1.7	1.6	4.5
50 kHz	4.1	5.7	4.0	3.8	4.3
250 kHz	3.8	5.6	2.9	2.9	2.9

Bioelectrical Impedance Vector Analysis

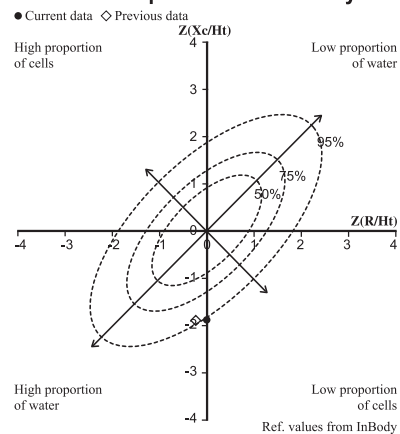

Impedance

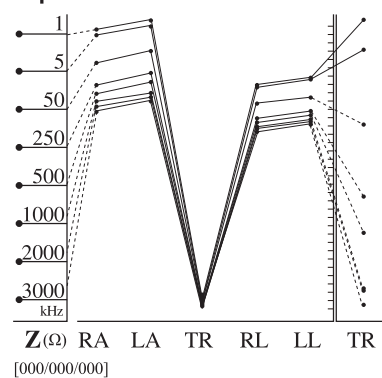

Evaluation Result Sheet

InBody Evaluation

[InBody970] [Yscope]

InBody

www.inbody.com

ID	Height	Age	Gender	Test Date / Time
Jane Doe	156.9cm	51	Female	2021.03.31. 15 : 44

Research Parameters

Whole Body Phase Angle_50kHz

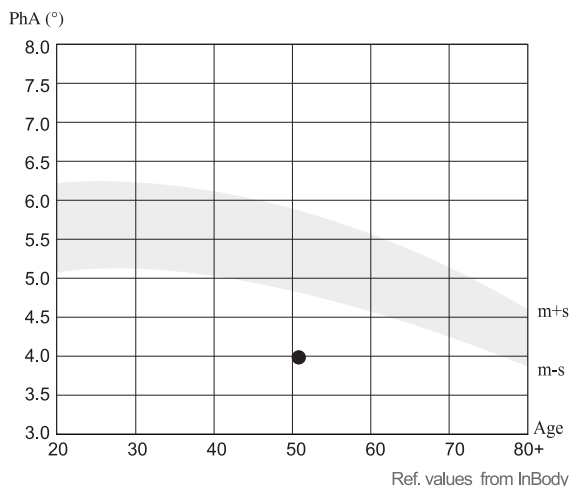

PhA (°)	Young adults (T-score)	Age-matched (Z-score)
4.0	-2.9	-2.4

Body Water Evaluation

Whole Body ECW Ratio

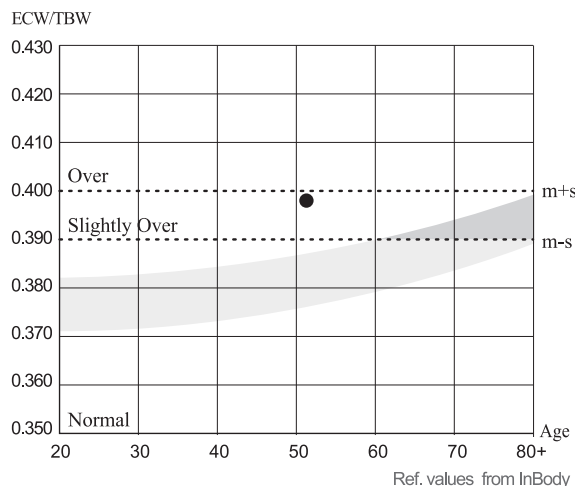

ECW/TBW	Young adults (T-score)	Age-matched (Z-score)
0.398	3.9	2.8

Muscle · Nutrition Evaluation

Skeletal Muscle mass Index

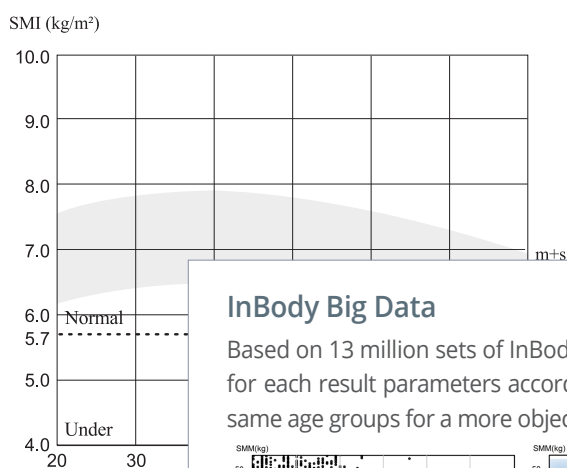

SMI (kg/m²)
5.8

Research Parameters

Body Cell Mass

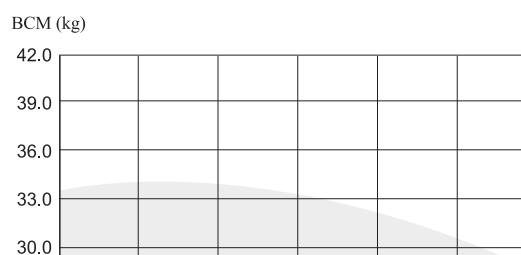

InBody Big Data

Based on 13 million sets of InBody Big Data, InBody provides averages and standard deviation graphs for each result parameters according to age. It allows for comparative evaluation between different or same age groups for a more objective body composition analysis.

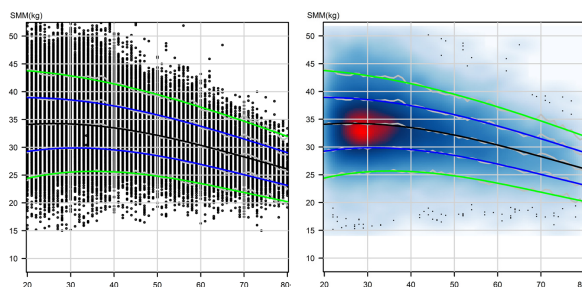

Skeletal Muscle Mass (SMM, kg)

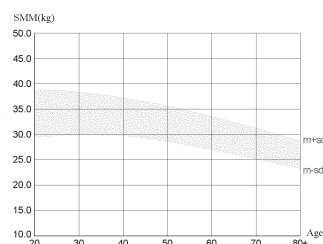

* InBody Big Data is used for the evaluation by age which is shown as T-Score and Z-score that indicate the relative position of subject.

It does not affect the subjects' body composition analysis result.

* Depending on the country, the graph will be set differently.

Research Result Sheet

InBody Research

[InBody970] [Yscope]

InBody

www.inbody.com

ID	Height	Age	Gender	Test Date / Time
Jane Doe	156.9cm	51	Female	2021.03.31. 15 : 44

Body Composition Summary

	FFM	FM	ICW	ECW	TBW	ECW/TBW
Right Arm	2.00 kg	1.6 kg	0.96 L	0.59 L	1.55 L	0.378
Left Arm	1.91 kg	1.6 kg	0.93 L	0.56 L	1.49 L	0.378
Trunk	17.7 kg	11.8 kg	8.3 L	5.5 L	13.8 L	0.398
Right Leg	5.24 kg	3.0 kg	2.46 L	1.66 L	4.12 L	0.403
Left Leg	5.15 kg	3.0 kg	2.41 L	1.64 L	4.05 L	0.404
Whole Body	37.1 kg	22.0 kg	16.5 L	10.9 L	27.4 L	0.398
Weight	59.1 kg		* The difference between the whole body values and sum of segmental values are from the craniocervical region.			

Research Parameters

Body Mass Index	24.0 kg/m ² (18.5~25.0)
Percent Body Fat	37.2 % (18.0~28.0)
Skeletal Muscle Mass	19.5 kg (19.5~23.9)
Soft Lean Mass	34.9 kg (33.8~41.4)
Protein	7.1 kg (7.0~8.6)
Mineral	2.64 kg (2.44~2.98)
Bone Mineral Content	2.18 kg (2.01~2.45)
Basal Metabolic Rate	1171 kcal (1255~1451)
Waist Hip Ratio	0.94 (0.75~0.85)
Waist Circumference	85.0 cm
Visceral Fat Area	116.8 cm ²
Obesity Degree	114 % (90~110)
Body Cell Mass	23.6 kg (23.4~28.6)
Arm Circumference	30.5 cm
Arm Muscle Circumference	26.0 cm
TBW/FFM	73.7 %
Fat Free Mass Index	15.1 kg/m ²
Fat Mass Index	8.9 kg/m ²
Skeletal muscle mass Index	5.8 kg/m ²

Body Composition Analysis

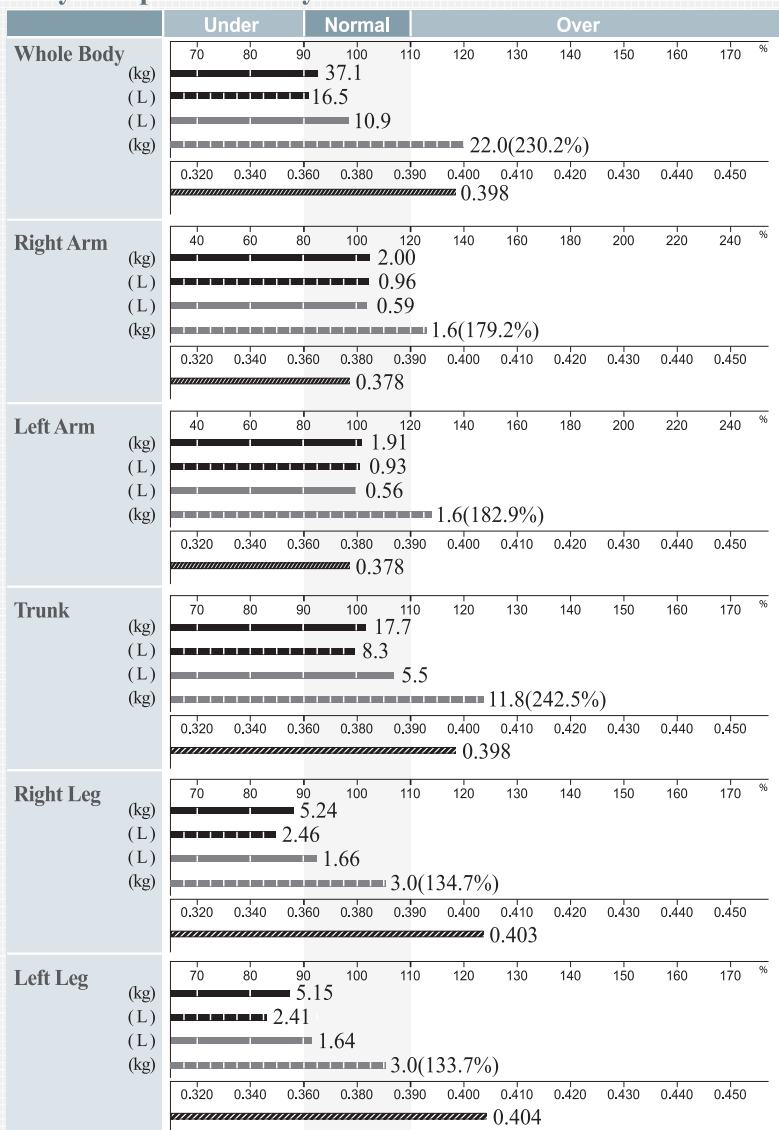

Whole Body Phase Angle

ϕ (°) 50 kHz | 4.0°

Segmental Body Phase Angle

	RA	LA	TR	RL	LL
ϕ (°) 5 kHz	1.7	4.7	1.7	1.6	4.5
50 kHz	4.1	5.7	4.0	3.8	4.3
250 kHz	3.8	5.6	2.9	2.9	2.9

Impedance

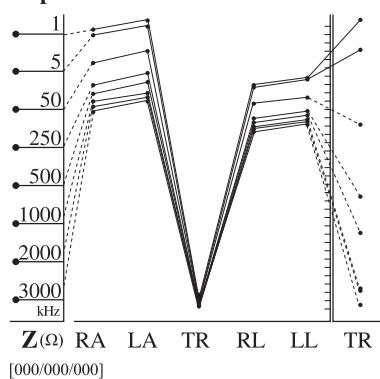

Comparison Result Sheet

InBody Comparison [InBody970] [Yscope]

InBody
www.inbody.com

ID	Height	Age	Gender	Test Date / Time
Jane Doe	156.9cm	51	Female	2021.03.31. 15 : 44

— Standard median curve ● Today's Results ○ Recent Results
(2021.03.20 15:12)

Whole Body	Today	Recent	Difference
Weight (kg)	59.1	60.5	-1.4
SMM (kg) <small>Skeletal Muscle Mass</small>	19.5	19.8	-0.3
Body Fat Mass (kg)	22.0	22.8	-0.8
ECW Ratio	0.398	0.398	0.000
Phase Angle (°)	4.0	4.1	-0.1

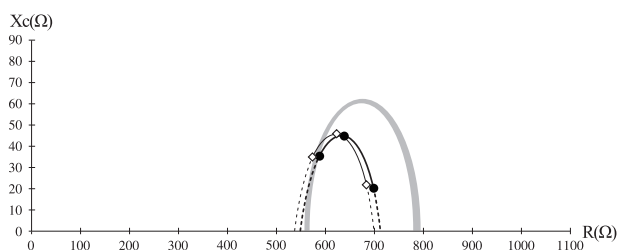

Right Arm	Today	Recent	Difference
Lean Mass (kg)	2.00	2.06	-0.06
ECW Ratio	0.378	0.378	0.000
Phase Angle (°)	4.1	4.3	-0.2
Left Arm	Today	Recent	Difference
Lean Mass (kg)	1.91	1.98	-0.07
ECW Ratio	0.378	0.377	+0.001
Phase Angle (°)	5.7	5.7	0.0

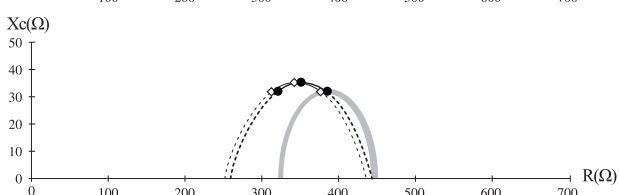
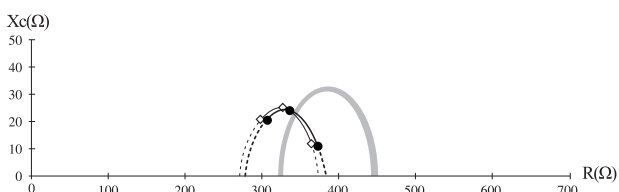

Right Leg	Today	Recent	Difference
Lean Mass (kg)	5.24	5.35	-0.11
ECW Ratio	0.403	0.403	0.000
Phase Angle (°)	3.8	3.8	0.0
Left Leg	Today	Recent	Difference
Lean Mass (kg)	5.15	5.26	-0.11
ECW Ratio	0.404	0.405	-0.001
Phase Angle (°)	4.3	4.3	0.0

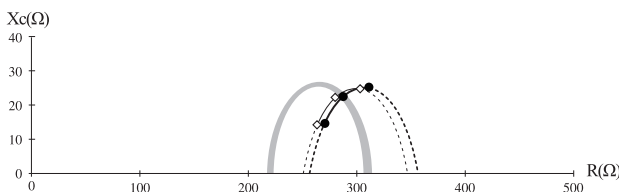
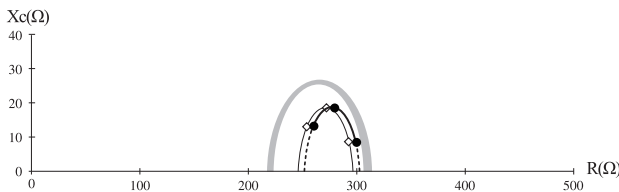

Trunk	Today	Recent	Difference
Lean Mass (kg)	17.7	18.0	-0.3
ECW Ratio	0.398	0.399	-0.00
Phase Angle (°)	4.0	4.1	-0.1

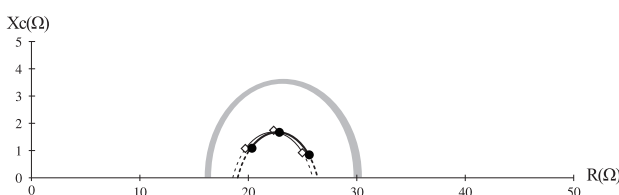

Yscope

Portable BIA abdominal fat analyzer

Abdominal Impedance



Abdominal Circumference



Radiation-free and Safe for Regular Measurement

Yscope provides a comprehensive abdominal fat analysis, including visceral fat and subcutaneous fat measurements using the same BIA technology behind the professional InBody devices. It is a non-invasive, radiation-free solution for regularly monitoring and managing abdominal fat.

Specialized Abdominal Fat Analysis

Besides fat analysis from InBody, Yscope provides in-depth analysis of abdominal fat for more accurate results.

The visceral fat and subcutaneous fat measurements provided by the Yscope have shown high correlation to CT scan results.

Easy and Quick Measurement

Yscope is a portable abdominal fat analyzer that can be integrated with the InBody970. In approximately 10 seconds, the Yscope provides a quick and easy solution for assessing essential abdominal parameters.



Yscope(970) \propto CT: VFA $R^2 = 0.862$

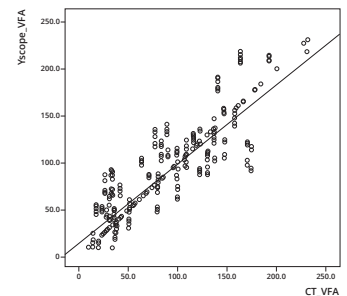

Yscope(970) \propto CT: SFA $R^2 = 0.967$

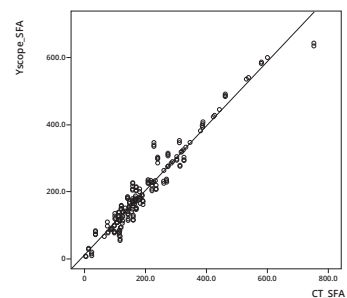

Yscope(970) \propto Tape measure: WC $R^2 = 0.982$

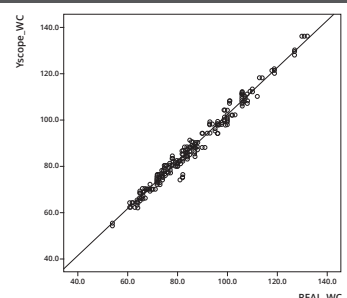

* When Yscope is not connected, result may vary.

Visceral Fat Result Sheet

InBody Visceral Fat

[InBody970] [Yscope]

InBody

www.inbody.com

ID	Height	Age	Gender	Test Date / Time
Jane Doe	156.9cm	51	Female	2021.03.31. 15 : 44

Body Fat Composition

	Values	Abdominal Fat Mass	Trunk Fat Mass	Body Fat Mass	Weight
Subcutaneous Fat (kg)	1.58 (0.90 ~ 1.81)	2.64 (1.35 ~ 2.71)	11.8 (3.9 ~ 7.8)	22.0 (10.3 ~ 16.5)	59.1 (43.9 ~ 59.5)
Visceral Fat (kg)	1.06 (0.45 ~ 0.90) Non-Abdominal Fat				
Arms/Legs Fat (kg)	9.1 (4.9 ~ 9.9)				
Fat Free Mass (kg)	37.1 (35.8 ~ 43.8)				

* The difference between the whole body values and sum of segmental values are from the craniocervical region.

Body Fat Analysis

	Under	Normal	Over
Weight (kg)	55 70 85 100 115 130 145 160 175 190 205 %	59.1	
Body Fat Mass (kg)	40 60 80 100 160 220 280 340 400 460 520 %	22.0	
BMI (kg/m ²) Body Mass Index	10.0 15.0 18.5 22.0 25.0 30.0 35.0 40.0 45.0 50.0 55.0	24.0	
PBF (%) Percent Body Fat	8.0 13.0 18.0 23.0 28.0 33.0 38.0 43.0 48.0 53.0 58.0	37.2	

Abdominal Fat Analysis

	Under	Normal	Over
Abdominal Fat (kg)	40.0 60.0 80.0 100.0 160.0 220.0 280.0 340.0 400.0 460.0 520.0 %	2.64	
Subcutaneous Fat (kg)	40.0 60.0 80.0 100.0 160.0 220.0 280.0 340.0 400.0 460.0 520.0 %	1.58	
Visceral Fat (kg)	40.0 60.0 80.0 100.0 160.0 220.0 280.0 340.0 400.0 460.0 520.0 %	1.06	

Abdominal Obesity Analysis

	Under	Normal	Over
Waist-Hip Ratio	0.65 0.70 0.75 0.80 0.85 0.90 0.95 1.00 1.05 1.10 1.15	0.94	
V/S Ratio Visceral/Subcutaneous Fat Ratio	0.10 0.20 0.30 0.40 0.50 0.60 0.70	0.67	

Body Fat History

	20.07.21 15:11	20.08.27 14:58	20.09.20 15:02	20.11.23 15:23	20.12.21 15:00	21.02.19 14:52	21.03.20 15:12	21.03.31 15:44
Weight (kg)	65.3	63.9	62.4	61.8	62.3	60.9	60.5	59.1
Body Fat Mass (kg)	27.0	26.0	24.5	24.1	24.5	23.5	22.9	22.0
Abdominal Fat (kg)	3.24	3.12	2.94	2.89	2.95	2.82	2.75	2.64
Subcutaneous Fat (kg)	1.94	1.87	1.76	1.73	1.76	1.69	1.64	1.58
Visceral Fat (kg)	1.30	1.25	1.18	1.16	1.18	1.13	1.10	1.06

Recent Total

Subcutaneous Fat Area

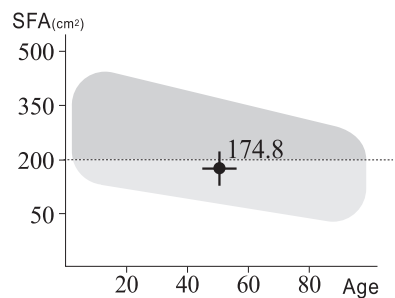

Ref. Matsushita et al, Diabetology & Metabolic Syndrome 2014, 6:11
Nakajima T. et al, Gastroenterology and Hepatology Research 2012, 1:11

Visceral Fat Area

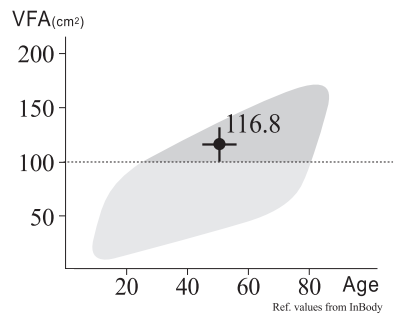

Research Parameters

Waist Circumference	85.0 cm
Obesity Degree	114 % (90~110)
Waist-Height Ratio	0.54 (0.51 Under)
Body Adiposity Index	28.1 (26.9 Under)
ABSI	0.081 (0.076 Under)
Conicity Index	1.27 (1.25 Under)
Basal Metabolic Rate	1171 kcal (1255~1451)
ECW Ratio	0.398 (0.360~0.400)
SMI	5.8 kg/m ²
FMI	8.9 kg/m ²
Lean Mass/Visceral Fat Area	0.17 kg/m ² (0.15 Over)

Impedance

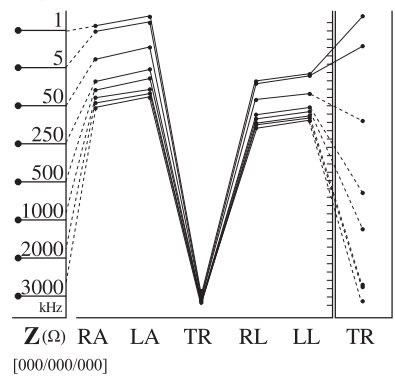

Body Composition Result Sheet for Children



[InBody970] [Yscope]



www.inbody.com

ID	Height	Age	Gender	Test Date / Time
John Doe	139.4cm	10	Male	2021.03.31. 16:40

Body Composition Analysis

Total amount of water in my body	Total Body Water	(L)	19.1 (18.0 ~ 22.0)
What I need to build muscles	Protein	(kg)	5.1 (4.9 ~ 5.9)
What I need for strong bones	Mineral	(kg)	1.91 (1.66 ~ 2.04)
Where my excess energy is stored	Body Fat Mass	(kg)	8.9 (3.8 ~ 7.7)
Sum of the above	Weight	(kg)	35.0 (27.3 ~ 36.9)

Muscle-Fat Analysis

	Under	Normal	Over
Weight (kg)	55 70 85 100 115 130 145 160 175 190 205 %		
	35.0		
SMM (kg)	70 80 90 100 110 120 130 140 150 160 170 %		
Skeletal Muscle Mass	13.3		
Body Fat mass (kg)	40 60 80 100 160 220 280 340 400 460 520 %		
	8.9		

Obesity Analysis

	Under	Normal	Over
BMI (kg/m ²)	7.9 10.9 13.9 16.4 18.6 20.2 22.2 24.2 26.2 28.2 30.2		
Body Mass Index	18.0		
PBF (%)	0.0 5.0 10.0 15.0 20.0 25.0 30.0 35.0 40.0 45.0 50.0		
Percent Body Fat	25.6		

Growth Graph

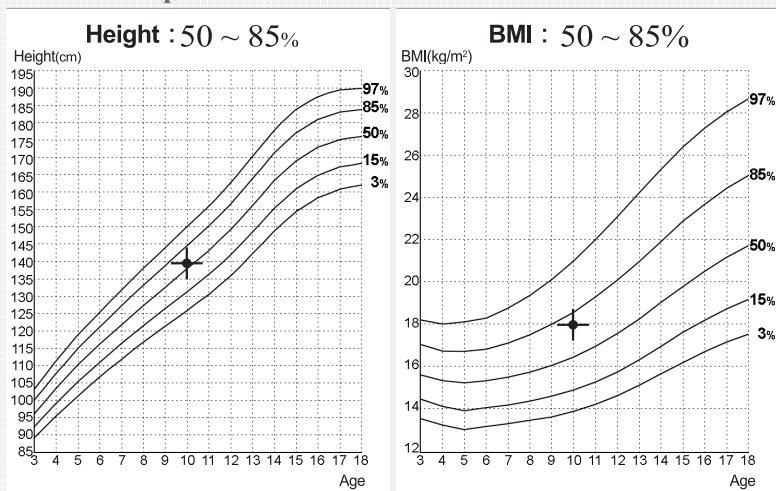

Body Composition History

	19.07.15	19.11.19	20.01.29	20.03.15	20.06.21	20.09.19	20.12.20	21.03.31
Height (cm)	134.5	135.2	136.4	137.2	137.9	138.5	139.0	139.4
Weight (kg)	30.8	31.3	32.0	32.8	33.5	34.0	34.4	35.0
SMM (kg)	12.5	12.7	12.8	13.0	13.1	13.1	13.2	13.3
PBF (%)	20.4	20.7	21.6	22.3	23.1	24.3	25.1	25.6
<input checked="" type="checkbox"/> Recent <input type="checkbox"/> Total	19.07.15 14:22	19.11.19 09:30	20.01.29 15:18	20.03.15 11:00	20.06.21 15:00	20.09.19 14:52	20.12.20 15:12	21.03.31 16:40

Growth Score

85 / 100 Points

* If tall and within great body comparison standards, the growth score may surpass 100 points.

Nutrition Evaluation

- Protein Normal Deficient
- Minerals Normal Deficient
- Body Fat Normal Deficient Excessive

Obesity Evaluation

- BMI Normal Under Slightly Over Over
- PBF Normal Slightly Over Over

Body Balance Evaluation

- Upper Balanced Slightly Unbalanced Extremely Unbalanced
- Lower Balanced Slightly Unbalanced Extremely Unbalanced
- Upper-Lower Balanced Slightly Unbalanced Extremely Unbalanced

Segmental Lean Analysis

Right Arm	0.95 kg
Left Arm	0.94 kg
Trunk	10.8 kg
Right Leg	3.41 kg
Left Leg	3.37 kg

Research Parameters

Basal Metabolic Rate	933 kcal (948 ~ 1077)
Child Obesity Degree	109 % (90 ~ 110)

Whole Body Phase Angle

ϕ (°) 50 kHz | 4.3°

Segmental Body Phase Angle

ϕ (°)	RA	LA	TR	RL	LL
5 kHz	1.4	1.4	3.0	1.9	1.8
50 kHz	3.6	3.3	6.8	5.0	4.8
250 kHz	3.7	3.6	9.4	5.0	4.9

Impedance

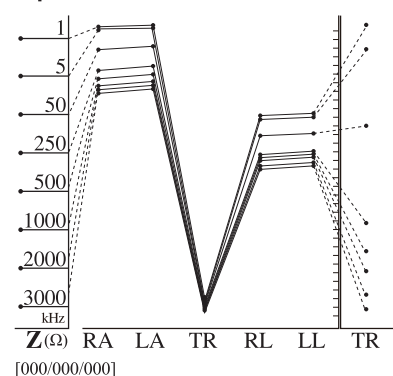

Data Management Program

LookinBody Web allows you to view InBody data through cloud, and provides an analytical dashboard by the branches, or staff.

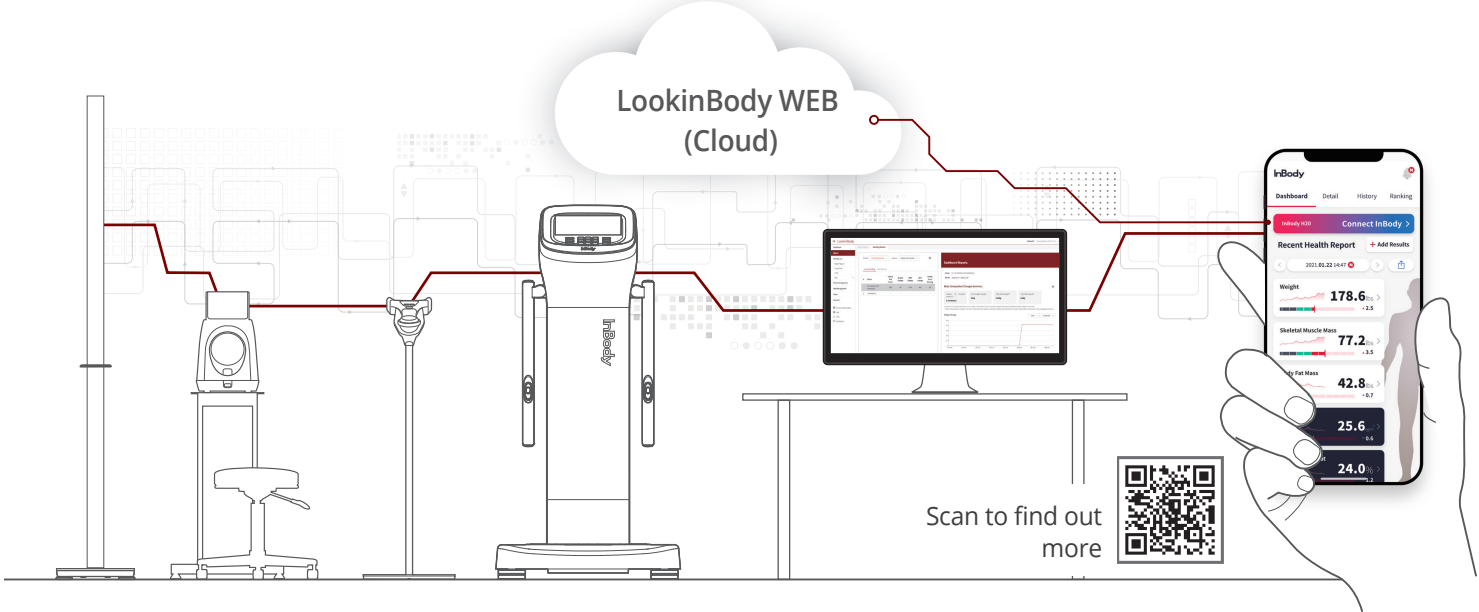
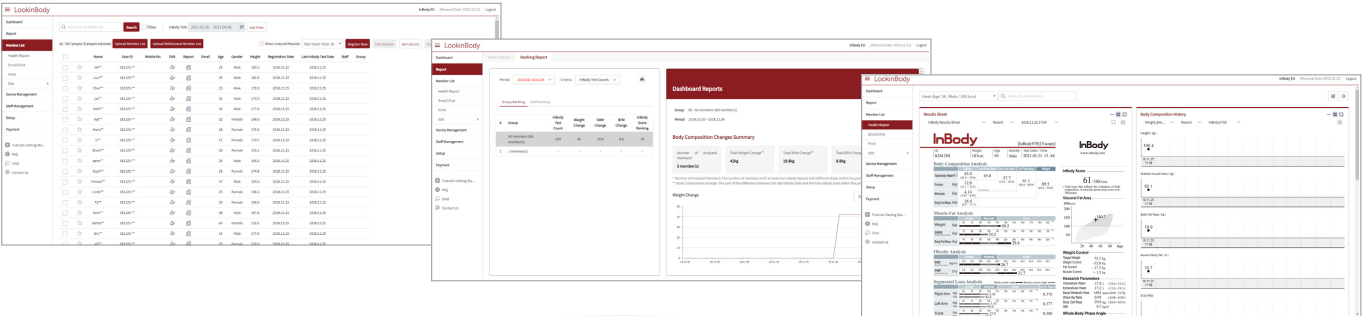

InBody Integration Solution



InBody Health Check-up

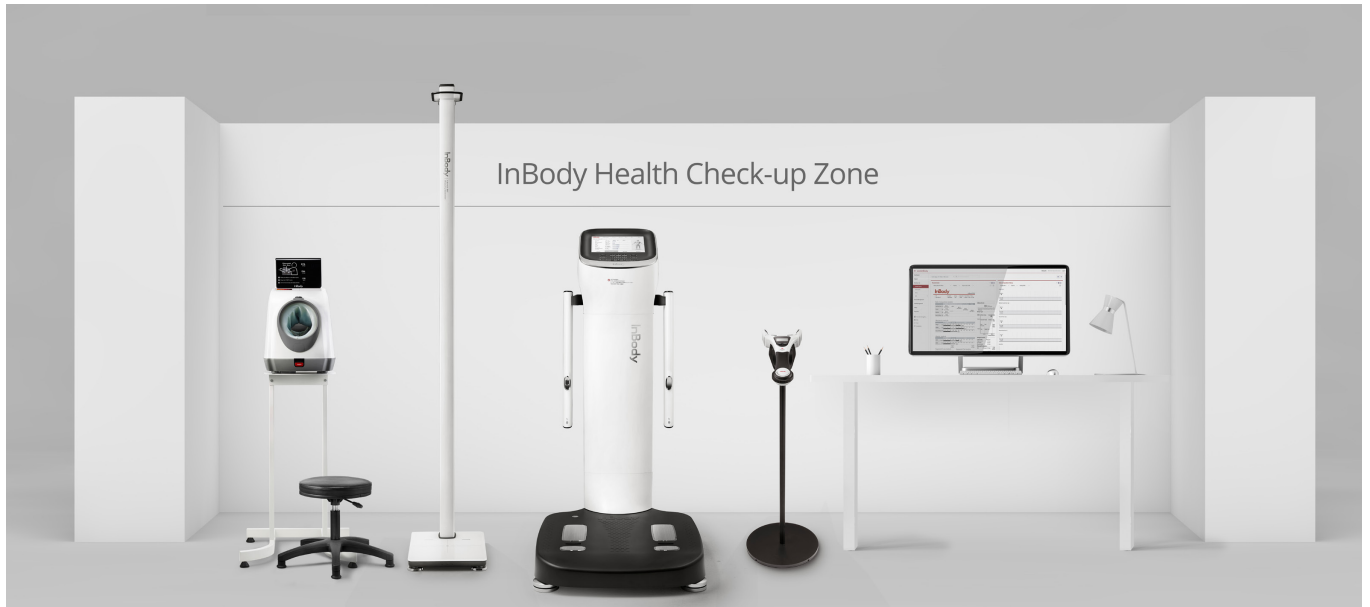

1
STEP

Blood Pressure Test

Start measuring blood pressure with BPBIO, and the test result will automatically be transferred to InBody device.



2
STEP

Stadiometer Test

Measure your height with BSM. Accurate height measurement is crucial for a precise InBody Test



3
STEP

Yscope Test

Pull the lever to get the impedance, and roll the wheel to measure the circumference.

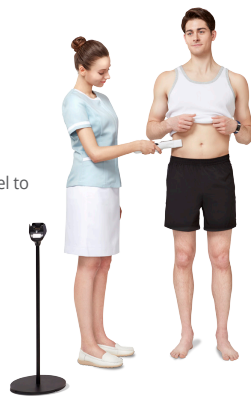

4
STEP

Member Identification

Identify Members with InBody BAND, Fingerprint or Barcode Scanner



5
STEP

InBody Test

Take the InBody Test by stepping on the footplate and grabbing the handles.



6
STEP

Get Your Result

Get a comprehensive test result in one page and consult with professionals.

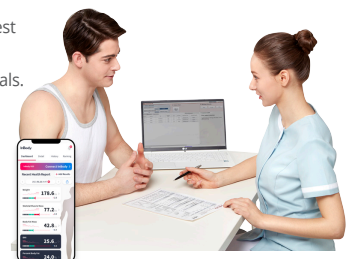

Specifications

InBody 970 BODY COMPOSITION ANALYZER

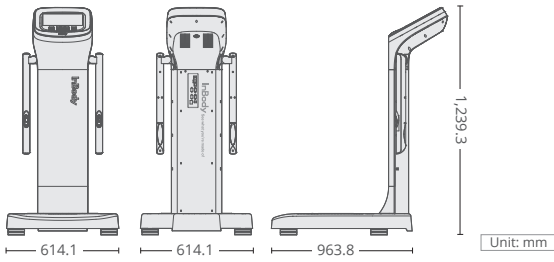

Bioelectric Impedance Analysis (BIA) Measurement Item	Bioelectrical Impedance(Z)	40 Impedance Measurements by Using 8 Different Frequencies (1kHz, 5kHz, 50kHz, 250kHz, 500kHz, 1MHz, 2MHz, 3MHz) at Each of 5 Segments (Right Arm, Left Arm, Trunk, Right Leg and Left Leg)
	Phase Angle	15 Phase Angle Measurements by Using 3 Different Frequencies (5kHz, 50kHz, 250kHz) at Each of 5 Segments (Right Arm, Left Arm, Trunk, Right Leg, and Left Leg)
Electrode Method	Tetrapolar 8-Point Tactile Electrodes	
Measurement Method	Direct Segmental Multi-Frequency Bioelectrical Impedance Analysis (DSM-BIA) Simultaneous Multi-Frequency Bioelectrical Impedance Analysis (SMF-BIA)	
Body Composition Calculation Method	No Empirical Estimation (Age and Gender does not affect the result)	
Compatible Device	BSM Series (BSM170B, BSM370, BSM270B), BPBIO Series (BPBIO320, BPBIO750), Yscope, and InBodyBAND Series	
Logo Display	Name, Address and Content Information can be shown on the Results Sheet	
Digital Results	LCD Screen, LookinBody Web, LookinBody120	
Type of Result Sheets	Body Composition Result Sheet, Body Water Result Sheet, Evaluation Result Sheet, Research Result Sheet, Comparison Result Sheet, Result Sheet for Children, Visceral Fat Result Sheet	
Voice Guidance	Audible guidance for test in progress and test complete	
Data Storage	Saves up to 100,000 measurements (When ID is entered)	
Administrator Menu	Setup: Configure settings and manage data Troubleshooting: Additional information to help use the InBody970	
InBody USB	Copy, backup, or restore the LookinBody test data (data can be viewed on Excel or LookinBody120)	
Barcode Reader	Member ID will be automatically inputted when the Barcode is scanned	
InBodyBAND Series Recognition Function	Recognizes the InBodyBAND series of the subject and automatically inputs personal information to the InBody970	
Fingerprint Recognition Function	Recognizes the fingerprint of the measurer and automatically inputs personal information to the InBody970	
Backup data	Backup data saved in InBody970 by using an InBody USB	
QR Code	See your result on InBody mobile App	
Applied Rating Current	1kHz : 70uA (+-10uA), Over 5kHz : 300uA (+-30uA)	
Adapter	Bridgepower	Power Input AC 100-240V, 50-60Hz, 1.2A (1.2A-0.6A) Power Output DC 12V, 3.4A
	Mean Well	Power Input AC 100-240V, 50-60Hz, 1.0-0.5A (GSM40A12-P1R) Power Output DC 12V, 3.34A
Display Type	1280 x 800 10.1inch Color TFT LCD	
Internal Interface	Touchscreen, Keypad	
External Interface	RS-232C 4EA, USB Host 2EA, USB Slave 1EA, LAN(10/100T) 1EA, Bluetooth 1EA, Wi-Fi 1EA	
Compatible Printer	InBody970 compatible printers available at www.inbodyservice.com	
Dimensions	614.1(W) x 963.8(L) x 1239.3(H): mm	
Equipment Weight	46kg (101.4lb)	
Test Duration	About 90 seconds	
Operation Environment	10~40°C (50~104°F), 30~75% RH, 70~106kPa	
Storage Environment	-10~70°C (14~158°F), 10~80% RH, 50~106kPa (No Condensation)	
Weight Range	5~300kg (11~660.1lb)	
Age Range	3~99 years	
Height Range	95~220cm (3ft 1.40in ~ 7ft 2.61in)	

Body Composition Result Sheet	Result parameters and Result interpretation • Body Composition Analysis (Total Body Water, Protein, Mineral, Body Fat Mass, Weight) • Muscle-Fat Analysis (Weight, Skeletal Muscle Mass, Body Fat Mass) • Obesity Analysis (Body Mass Index, Percent Body Fat) • Segmental Lean Analysis • Segmental Fat Analysis • Segmental ICW Analysis • Segmental ECW Analysis • ECW Ratio Analysis (ECW Ratio) • Segmental ECW Ratio • Body Composition History (Weight, Skeletal Muscle Mass, Percent Body Fat, ECW Ratio) • InBody Score • Visceral Fat Area (Graph) • Weight Control (Target Weight, Weight Control, Fat Control, Muscle Control) • Body Type (Graph) • Nutrition Evaluation (Protein, Minerals, Fat Mass)	• Obesity Evaluation (BMI, Percent Body Fat) • Body Balance Evaluation (Upper, Lower, Upper-Lower) • Waist-Hip Ratio (Graph) • Visceral Fat Level (Graph) • Research Parameters (Extracellular Water, Intracellular Water, Skeletal Muscle Mass, Fat Free Mass, Basal Metabolic Rate, Waist-Hip Ratio, Visceral Fat Level, Visceral Fat Area, Obesity Degree, Bone Mineral Content, Body Cell Mass, Arm Circumference, Arm Muscle Circumference, FMI, FFMI, SMI, Recommended Calorie Intake, Calorie Expenditure of Exercise, InBody Score) • Blood Pressure (Max/Min/Pulse Rate, Avg/Pulse pressure/R.P.P) • Result Interpretation QR Code • QR Code • Segmental Body Phase Angle (5kHz, 50kHz, 250kHz: Right Arm, Left Arm, Trunk, Right Leg, Left Leg) • Whole Body Phase Angle (50kHz) • Impedance Graph (Each segment and each frequency)
--------------------------------------	--	--

Body Composition Result Sheet for Children	Result parameters and Result interpretation • Body Composition Analysis (Total Body Water, Protein, Mineral, Body Fat Mass, Fat Free Mass, Soft Lean Mass, Weight) • Muscle-Fat Analysis (Weight, Skeletal Muscle Mass, Body Fat Mass) • Obesity Analysis (Body Mass Index, Percent Body Fat) • Growth Graph (Height, Weight, BMI) • Growth Score • Body Composition History (Height, Weight, Skeletal Muscle Mass, Percent Body Fat) • Nutrition Evaluation (Protein, Minerals, Fat Mass) • Obesity Evaluation (BMI, Percent Body Fat) • Body Balance (Upper, Lower, Upper-Lower) • Segmental Lean Analysis (Right Arm, Left Arm, Trunk, Right Leg, Left Leg)	• Segmental Body Water Analysis (Right Arm, Left Arm, Trunk, Right Leg, Left Leg) • Research Parameters (Intracellular Water, Extracellular Water, Basal Metabolic Rate, Child Obesity Degree, Bone Mineral Content, Body Cell Mass, FFMI, FMI) • Blood Pressure (Max/Min/Pulse Rate, Avg/Pulse pressure/R.P.P) • Result Interpretation QR Code • QR Code • Segmental Body Phase Angle (5kHz, 50kHz, 250kHz: Right Arm, Left Arm, Trunk, Right Leg, Left Leg) • Whole Body Phase Angle (50kHz) • Impedance Graph (Each segment and each frequency)
---	--	---

Body Water Result Sheet	Result parameters and Result interpretation • Body Water Composition (Total Body Water, Intracellular Water, Extracellular Water) • ECW Ratio Analysis (ECW Ratio) • Segmental Body Water Analysis (Right Arm, Left Arm, Trunk, Right Leg, Left Leg) • Body Composition Analysis (Protein, Minerals, Body Fat Mass, Fat Free Mass, Bone Mineral Content) • Segmental ECW Analysis (Right Arm, Left Arm, Trunk, Right Leg, Left Leg) • Body Water Composition History (Weight, Total Body, Intracellular Water, Extracellular Water, Extracellular Water Ratio) • Muscle-Fat Analysis (Weight, Skeletal Muscle Mass, Soft Lean Mass, Body Fat Mass)	• Obesity Evaluation (BMI, Percent Body Fat) • Research Parameters (Fat Free Mass, Basal Metabolic Rate, Waist-Hip Ratio, Visceral Fat Area, Obesity Degree, Body Cell Mass, Arm Circumference, Arm Muscle Circumference, TBW/FFM, FMI, FFMI, SMI) • Blood Pressure (Max/Min/Pulse Rate, Avg/Pulse pressure/R.P.P) • Result Interpretation QR Code • QR Code • Segmental Body Phase Angle (5kHz, 50kHz, 250kHz: Right Arm, Left Arm, Trunk, Right Leg, Left Leg) • Whole Body Phase Angle (50kHz) • Impedance Graph (Each segment and each frequency)
--------------------------------	---	--

Evaluation Result Sheet	• Whole Body ECW Ratio (ECW/TBW): (T-Score, Z-score) • Visceral Fat Area (VFA,cm²): (T-Score, Z-score) • Body Mass Index (BMI,kg/m²): (T-Score, Z-score) • Bioelectrical Impedance Vector Analysis (BIVA) • Whole Body Phase Angle_50kHz (PhA°): (T-Score, Z-score) • ECW Ratio (ECW/TBW) Balance (Right Arm, Left Arm, Trunk, Right Leg, Left Leg): Evaluation • Percent Body Fat (PBF,%): (T-Score, Z-score) • Skeletal Muscle mass Index (SMI,m²): (T-Score, Z-score) • Fat Mass Index (FMI,kg/m²): (T-Score, Z-score) • Fat Free Mass Index (FFMI,kg/m²): (T-Score, Z-score) • Lean Mass (LM) Balance(Right Arm, Left Arm, Trunk, Right Leg, Left Leg): Amount, Evaluation	• Skeletal Muscle Mass and ECW Ratio (SMM,% & ECW/TBW) • Skeletal Muscle mass Index and ECW Ratio (SMI,kg/m² & ECW/TBW) • Waist Hip Ratio (WHR): (T-Score, Z-score) • Body Cell Mass (BCM,kg): (T-Score, Z-score) • Outer Circumference(cm) • Weight (kg): (T-Score, Z-score) • Skeletal Muscle Mass/WT • Extracellular Mass/Body Cell Mass (ECM/BCM): (T-Score, Z-score) • Total Body Water/Weight (%): (T-Score, Z-score)
--------------------------------	--	---

Comparison Result Sheet	• Weight, Skeletal Muscle Mass, Body Fat Mass, ECW Ratio, Phase Angle: Whole Body (Current Result, Previous Result, Current-Previous Result difference) • Lean Mass, ECW Ratio, Phase Angle: Right Arm, Left Arm, Trunk, Right Leg, Left Leg (Current Result, Previous Result, Current-Previous Result difference) • Cole-Cole Plot (Today, Recent, Standard Median Curve)	
--------------------------------	--	--

Research Result Sheet	• Body Composition Summary (Fat Free Mass, Body Fat Mass, Intracellular Water, Extracellular Water, Body Water, ECW Ratio, Weight) • Body Composition Analysis (Lean Mass, ICW, ECW, Fat Mass, ECW/TBW): Whole Body, Right Arm, Left Arm, Trunk, Right Leg, Left Leg • Research Parameters (BMI, Percent Body Fat, Percent Abdominal Fat, Visceral Fat Area, Obesity Degree, Waist Circumference, FMI, Skeletal Muscle Mass, FFMI, SMI, Protein, Body Cell Mass, Mineral, Bone Mineral Content, Basal Metabolic Rate, Arm Circumference, Arm Muscle Circumference, TBW/FFM) • Segmental Body Phase Angle (5kHz, 50kHz, 250kHz: Right Arm, Left Arm, Trunk, Right Leg, Left Leg) • Whole Body Phase Angle (50kHz) • Impedance Graph (Each segment and each frequency)	
------------------------------	---	--

Visceral Fat Result Sheet	• Body Fat Composition (Subcutaneous Fat, Visceral Fat, Abdominal Fat Mass, Arm/Leg Fat, Fat Free Mass, Trunk Fat Mass, Body Fat Mass, Weight) • Body Fat Analysis (Weight, Body Fat Mass, BMI, Percent Body Fat) • Abdominal Fat Analysis (Abdominal Fat Mass, Subcutaneous Fat Mass, Visceral Fat Mass) • Abdominal Obesity Analysis (Waist-Hip Ratio, Visceral/Subcutaneous Fat Ratio) • Visceral/Subcutaneous Fat Area Ratio	• Subcutaneous Fat Area • Visceral Fat Area • Body Fat Change (Weight, Body Fat Mass, Abdominal Fat Mass, Subcutaneous Fat Mass, Visceral Fat Mass) • Research Parameters (Waist Circumference, Obesity Degree, Waist/Height Ratio, Body Adiposity Index, ABSI, Conicity Index, Basal Metabolic Rate, ECW Ratio, SMI, FMI, Lean Mass/Visceral Fat Area) • Impedance Graph (Each segment and each frequency)
----------------------------------	--	---

Yscope ABDOMINAL FAT ANALYZER

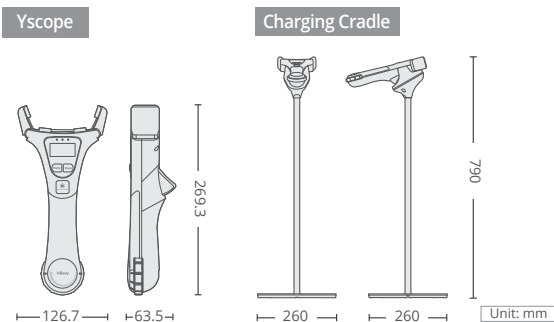

Bioelectrical Impedance Analysis (BIA)	Bioelectrical Impedance(Z)	Trunk Impedance Measurement at 50kHz, 250kHz
Electrode Method	Biopolar 4-point Tactile Electrodes	
Measurement Method	Direct-Segmental Multi-Frequency Bioelectrical Impedance Analysis (DSM-BIA) Simultaneous Multi-Frequency Bioelectrical Impedance Analysis (SMF-BIA)	
Body Composition Calculation Method	No Empirical Estimation (Age and Gender does not affect the result)	
Measurement Results	Visceral Fat Area, Subcutaneous Fat Area	
Applied Rating Current	350uA	
Rated Power	DC 3.63V, 2600mAh (Lithium ion battery)	
Charing Voltage	DC 5.0V	
Display	OLED	
Color	White	
Dimensions	Yscope (126.7(W) x 269.3(L) x 63.5(H) : mm) Charging Cradle (260(W) x 260(L) x 790(H) : mm)	
Equipment Weight	Yscope 0.3kg(0.7lb), Charging Cradle 2.5kg(5.5lb)	
Test Duration	About 5 seconds	
Operation Environment	10~40°C (50~104°F), 30~75% RH, 70~106kPa	
Storage Environment	-10~70°C (14~158°F), 10~80% RH, 50~106kPa (No Condensation)	
Age Range	3~99 years	

* Specifications may change without prior notice.
* QR Code is a registered trademark of DENSO WAVE INCORPORATED

InBody

See what you're made of

The power of InBody

InBody maintains a high brand position with the highest level of technology.



Certifications obtained by InBody

InBody complies with the quality management system according to international standards. We satisfy country-specific regulatory requirements that apply to product safety and performance, and provide related services.



InBody's Intellectual Property Rights

InBody owns patents and intellectual property rights around the world and provides products with high accuracy and reproducibility based on this technology.



InBody HQ [KOREA]

InBody Co., Ltd.
625, InBody Bldg., Eonju-ro,
Gangnam-gu, Seoul 06106
Republic of Korea
TEL: +82-2-501-3939 FAX: +82-2-578-5669
Website: <https://inbody.com>
E-mail: info@inbody.com

InBody USA [USA]

Biospace Inc. dba InBody
13850 Cerritos Corporate Dr. Unit C Cerritos,
CA 90703
USA
TEL: +1-323-932-6503 FAX: +1-323-952-5009
Website: <https://inbodyusa.com>
E-mail: info.us@inbody.com

InBody Japan [JAPAN]

InBody Japan Inc.
Tani Bldg., 1-28-6, Kameido, Koto-ku,
Tokyo 136-0071
Japan
TEL: +81-3-5875-5780 FAX: +81-3-5875-5781
Website: <https://www.inbody.co.jp>
E-mail: inbody@inbody.co.jp

InBody China [CHINA]

Biospace China Co., Ltd.
904, XingDi Plaza, No.1698 YiShanRoad,
Shanghai 201103
China
TEL: +86-21-6443-9705 FAX: +86-21-6443-9706
Website: <https://inbodychina.com>
E-mail: info@inbodychina.com

InBody Asia [ASIA]

InBody Asia Sdn. Bhd.
Unit 3A-11, Oval Damansara, 685 Jalan
Damansara Kuala Lumpur, WP KL 60000
Malaysia
TEL: +60-3-7732-0790 FAX: +60-3-7733-0790
Website: <https://inbodyasia.com>
E-mail: info@inbodyasia.com

InBody Europe [EU]

InBody Europe B.V.
Gyroscopweg 122, 1042 AZ,
Amsterdam,
The Netherlands
TEL: +31-20-238-6080 FAX: +31-6-5734-1858
Website: <https://nl.inbody.com>
E-mail: info.eu@inbody.com

InBody India [INDIA]

InBody India Pvt.Ltd.
Unit No. G-B 10, Ground Floor, Art Guild House, Phoenix
Market City, L.B.S. Marg, Kurla (West), Mumbai 400070
India
TEL : +91-22-6223-1911
Website: <http://inbody.in>
E-mail: india@inbody.com