



B Build Your Own | Collection

SB



NAILHEAD OPTIONS

The Panel and Deco arms are standard with nailhead. The Banded arm may be ordered with nailhead for an additional charge. The diagram below depicts placement.

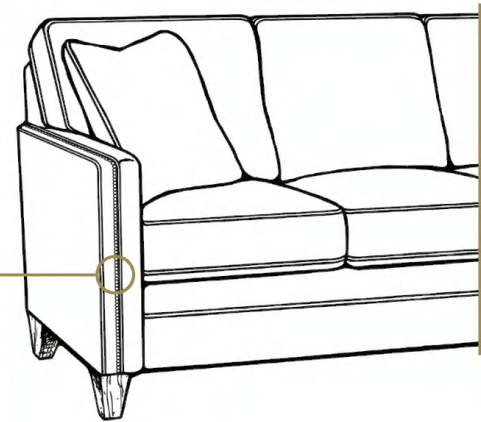

Small size, touching - Follows welt on Banded Arm

SAMPLE CONFIGURATIONS

SAMPLE CONFIGURATION DIMENSIONS REPRESENT PANEL ARM WITH SEMI-ATTACHED BACKS

(SEE BELOW FOR EXCEPTIONS). Diagrams below are not to scale. All dimensions are approximate and subject to change without notice.

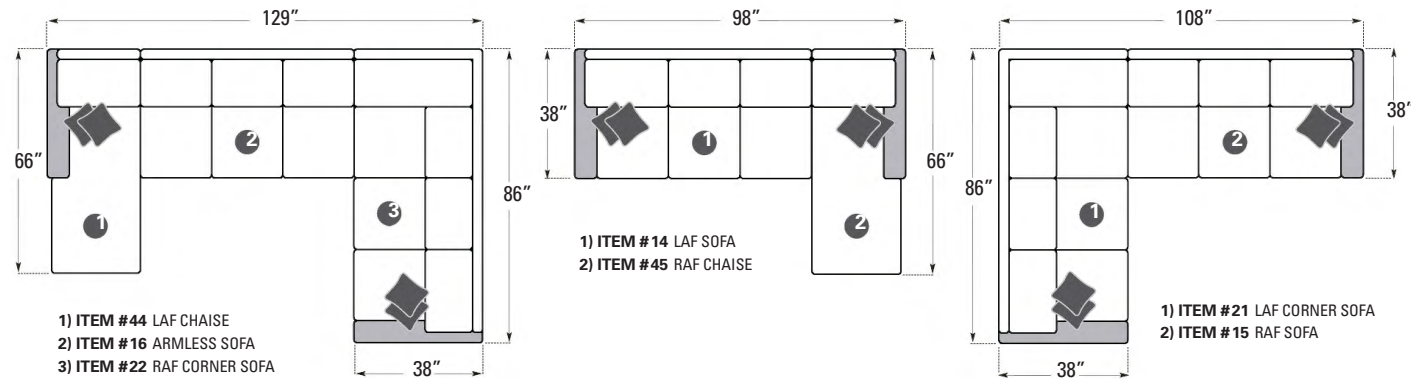

COMMON DIMENSIONS (unless otherwise noted)

OVERALL HEIGHT (Semi-Attached)	37"
OVERALL HEIGHT (Pullover)	35"
OVERALL DEPTH (Semi-Attached)	38"
OVERALL DEPTH (Pullover)	37"
ARM HEIGHT	26"
SEAT HEIGHT	21"
SEAT DEPTH (see diagram for exceptions)	21"

EXCEPTIONS

DECO & BANDED ARM: Subtract 1" PER ARM from overall frame length. Inside length does not change.

PULLOVER BACK: Pullover inside backs are approximately 1" less in overall depth (except on the wedge diagrams)



3000 Series

3000 SERIES | AVAILABLE PIECES

DIAGRAMS 1/4" = 1'
PILLOWS ARE NOT STANDARD ON LEATHER.

LAF = Left Arm Facing, RAF = Right Arm Facing

EXCEPTIONS

PANEL ARM WITH SEMI-ATTACHED BACK EXAMPLE DIAGRAMS SHOWN BELOW.

DECO & BANDED ARM: Subtract 1" PER ARM from overall frame length. Inside length does not change.

PULLOVER BACK: Pullover inside backs are approximately 1" less in overall depth (except on the wedge diagrams)

All dimensions are approximate and subject to change without notice. See www.smithbrothersfurniture.com for more detailed dimensions.

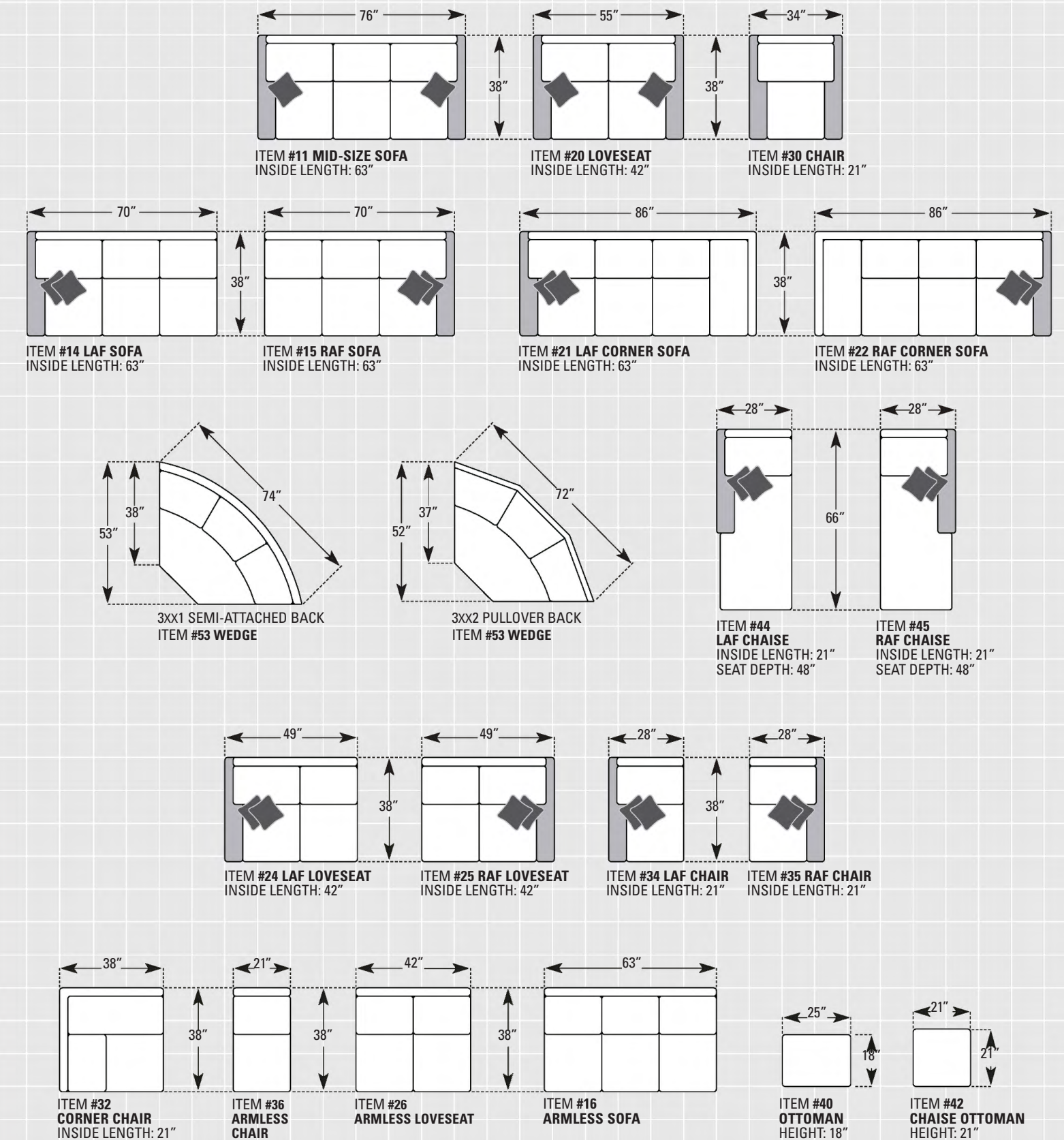



3211

Examples

3000 fabric sectional pieces with an arm: One pair style #13, 18" pillows with welt cord

Standard Pillows



3131-11 Mid-Size Sofa
Tapered Leg, Banded Arm, Semi-Attached Back
Standard with one pair style #13, 18" pillows



3121-30 Chair
Tapered Leg, Deco Arm,
Semi-Attached Back



3221-11 Leather Mid-size Sofa
Turned Leg, Deco Arm, Semi-Attached Back
Leather pieces are not standard with pillows

1 CHOOSE YOUR LEG

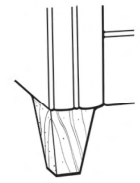

1 - Tapered Leg

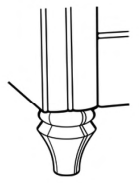

2 - Turned Leg

2 CHOOSE YOUR ARM

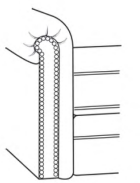

1 - Panel

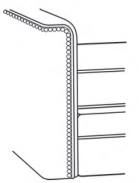

2 - Deco

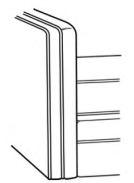

3 - Banded

3 CHOOSE YOUR BACK



1 - Semi-Attached Back

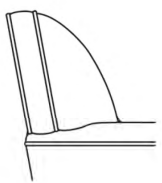

2 - Pullover



3112-30 Leather Chair
Tapered Leg, Panel Arm,
Pullover Back



3100-40 Leather Ottoman
Tapered Leg, No Arm, No Back



3132-30 Leather Chair
Tapered Leg, Banded Arm,
Pullover Back



3122-44 LAF Chaise
3102-26 Armless Loveseat
3122-22 RAF Corner Sofa
Tapered Leg, Deco Arm, Pullover Back
Standard with two pair style #13, 18" pillows



3131-14 LAF Sofa
3101-53 Wedge
3131-25 RAF Loveseat
Tapered Leg, Banded Arm, Semi-Attached Back
Shown standard with two pair style #13, 18" pillows

NAILHEAD OPTIONS

The 5000 series is not standard with nailhead, however it is an option. If nailhead is selected, it will be applied in the format shown below. Nailhead will be applied to the bottom of the baseband, as long as there is no skirt. It may be applied to the Panel Arm only, as the other arms cannot accept nailhead.

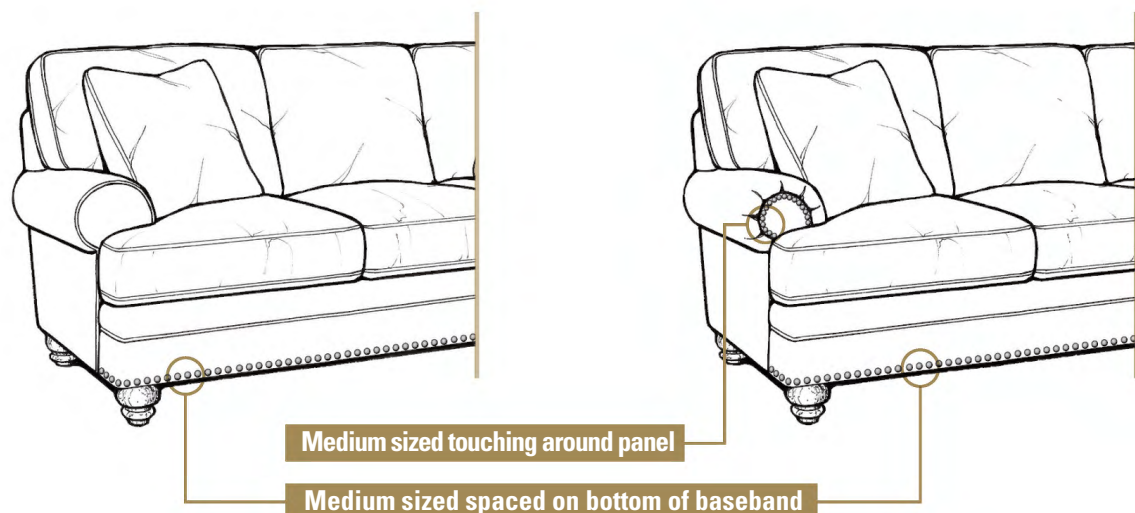

SAMPLE CONFIGURATIONS

SAMPLE CONFIGURATION DIMENSIONS REPRESENT PANEL AND SOCK ARMS WITH SEMI-ATTACHED BACKS (SEE BELOW FOR EXCEPTIONS). Diagrams below are not to scale. All dimensions are approximate.

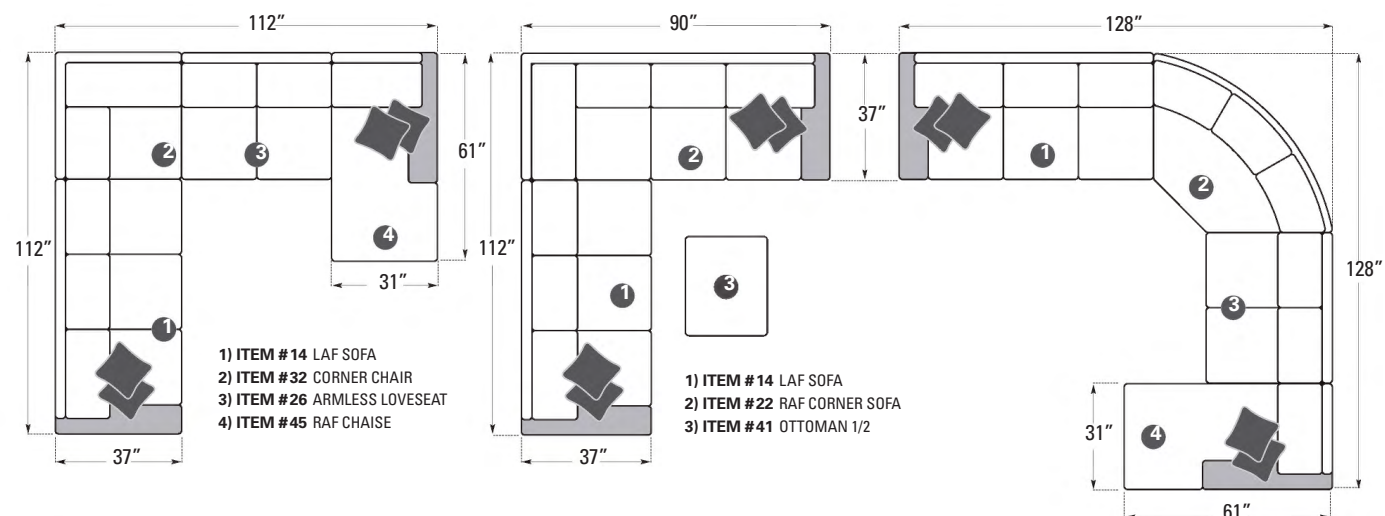

COMMON DIMENSIONS (unless otherwise noted)

OVERALL HEIGHT (exceptions below)	38"
OVERALL DEPTH (exceptions below)	37"
SEAT HEIGHT	20"
SEAT DEPTH (exceptions on back)	21"
ARM HEIGHT	24"

EXCEPTIONS (for loose pillow back option)

L/RAF CORNER SOFA (loose pillow back) OVERALL LENGTH	91"
CORNER CHAIR (loose pillow back) OVERALL LENGTH	38"
CONVERSATION SOFA (loose pillow back) LENGTH	106"
WEDGE (loose pillow back) DIAGONAL LENGTH	74"

- 1) ITEM #14 LAF SOFA
- 2) ITEM #32 CORNER CHAIR
- 3) ITEM #26 ARMLESS LOVESEAT
- 4) ITEM #45 RAF CHAISE

EXCEPTIONS

TRACK ARM: Subtract 2" PER ARM from overall frame length. Inside length does not change.
LOOSE PILLOW BACK: Add 1" to overall depth and overall height for pieces with loose pillow backs. Seat depth does not change.

VELCRO

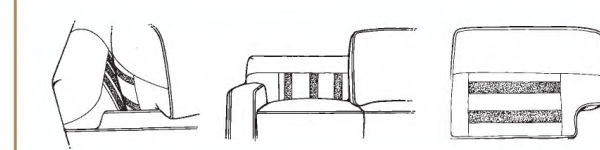

Leather styles feature velcro on the back side of the loose pillow backs. This method keeps the back cushions in place, as leather has a tendency to be slippery, causing them to slide down over the seat cushion.



SMITH BROTHERS
of BERNE

DESIGN Your Way

5251 LAF End Wedge, 5201 Armless Sofa, 5251 RAF Corner Sofa

5000 Series

5000 SERIES | AVAILABLE PIECES

DIAGRAMS 1/4"=1'
PILLOWS ARE NOT STANDARD ON LEATHER.

EXCEPTIONS

TRACK ARM: Subtract 2" PER ARM from overall frame length. Inside length does not change.
LOOSE PILLOW BACK: Add 1" to overall depth and overall height for pieces with loose pillow backs. Seat depth does not change.
 See inside for additional dimensions. All dimensions are approximate. See www.smithbrothers.net for more detailed dimensions.

LAF = Left Arm Facing, RAF = Right Arm Facing

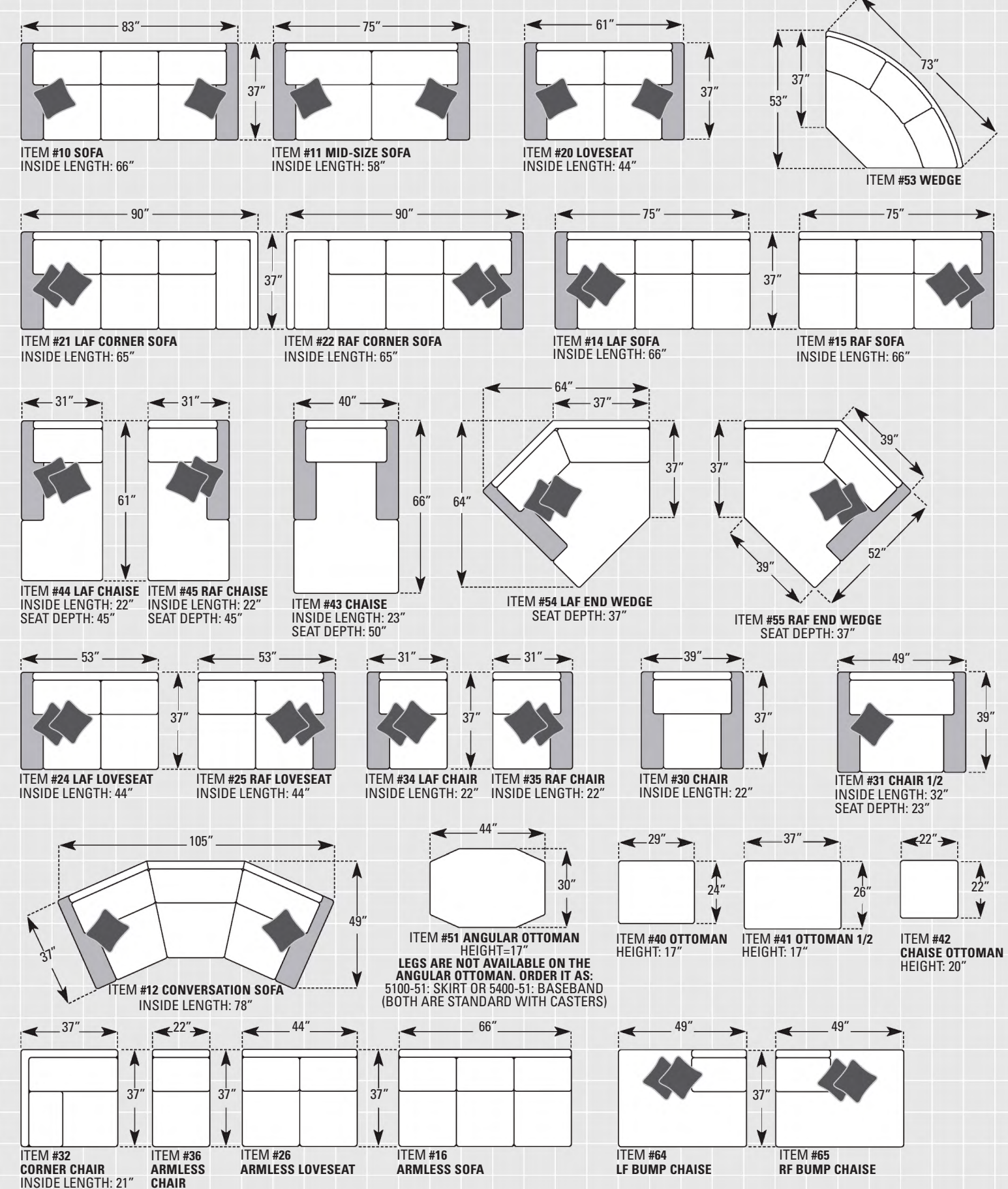



Examples

Standard Pillows
Style #13, 20" pillows with welt cord



5322-11 Mid-Size Sofa
Tapered Leg, Panel Arm with T-Cushion, Loose Pillow Back
Standard with one pair style #13, 20" pillows



5261-12 Conversation Sofa
Turned Leg, Panel Arm with Straight Cushion, Semi-Attached Back
Standard with one pair style #13, 20" pillows



5371-10 Leather Sofa
Tapered Leg, Track Arm with Straight Cushion, Semi-Attached Back



5311-31 Chair 1/2
Tapered Leg, Sock Arm with T-Cushion, Semi-Attached Back
Standard with one style #13, 20" pillow



5212-43 Chaise*
Turned Leg, Sock Arm with T-Cushion, Loose Pillow Back

5100-51 Angular Ottoman
with Skirt (standard with casters)



5301-64 LF Bump Chaise
5301-32 Corner Chair
5331-15 RAF Sofa
Tapered Leg, Track Arm with T-Cushion, Semi-Attached Back
Standard with two pair style #13, 20" pillows



5351-21 LAF Corner Sofa
5301-16 Armless Sofa
5351-55 RAF End Wedge*
Tapered Leg, Sock Arm with Straight Cushion, Semi-Attached Back
Standard with two pair style #13, 20" pillows

1 CHOOSE YOUR BASE

*Skirt option is not available in leather.
*Ottomans with a skirt are standard with casters.

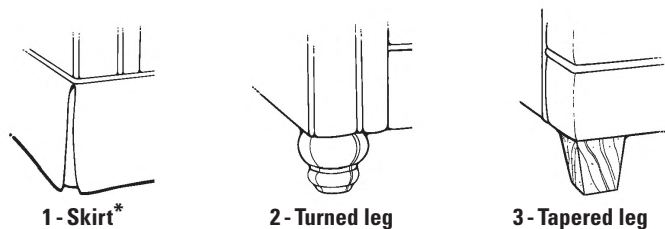

2 CHOOSE YOUR ARM

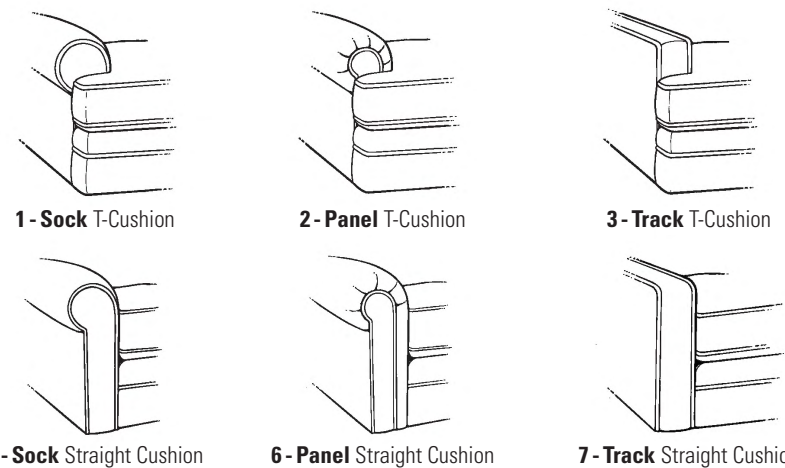

3 CHOOSE YOUR BACK

*Loose Pillow Back options incur an additional charge.

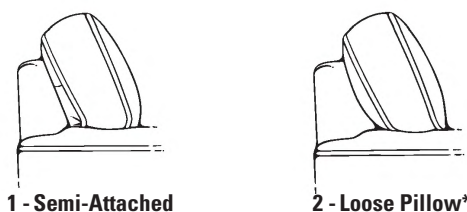

WRITE YOUR ORDER **5 1 2 3** - ITEM #
BASE ARM BACK

For pieces where a style code does not apply (such as arm styles on armless pieces), enter "0" in that position. For example, an Ottoman SKU (item #40) with a skirt would be written as 5100-40. Only the Base Style Code and the Item Number are needed because Arms and Backs do not apply in this case.

For more detailed information go to: www.smithbrothers.net

*Note: End Wedges and all Chaises will always feature T-Cushions, even when ordered with Straight Cushion Arms (5, 6, and 7).

NAILHEAD OPTIONS

The 8000 series is not standard with nailhead, however it is an option. If nailhead is selected, it will be applied in the format shown below. Nailhead will be applied to the bottom of the base. It may be applied to the Panel Arm only, as the other arms cannot accept nailhead.

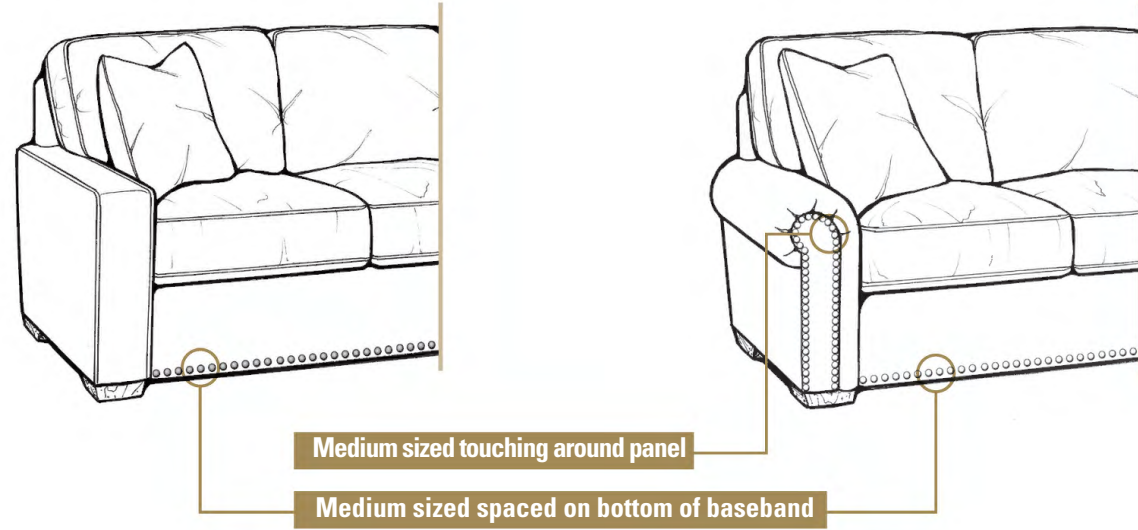

SAMPLE CONFIGURATIONS

SAMPLE CONFIGURATION DIMENSIONS REPRESENT PANEL AND SOCK ARMS WITH SEMI-ATTACHED BACKS (SEE BELOW FOR EXCEPTIONS). Diagrams below are not to scale. All dimensions are approximate and subject to change without notice.

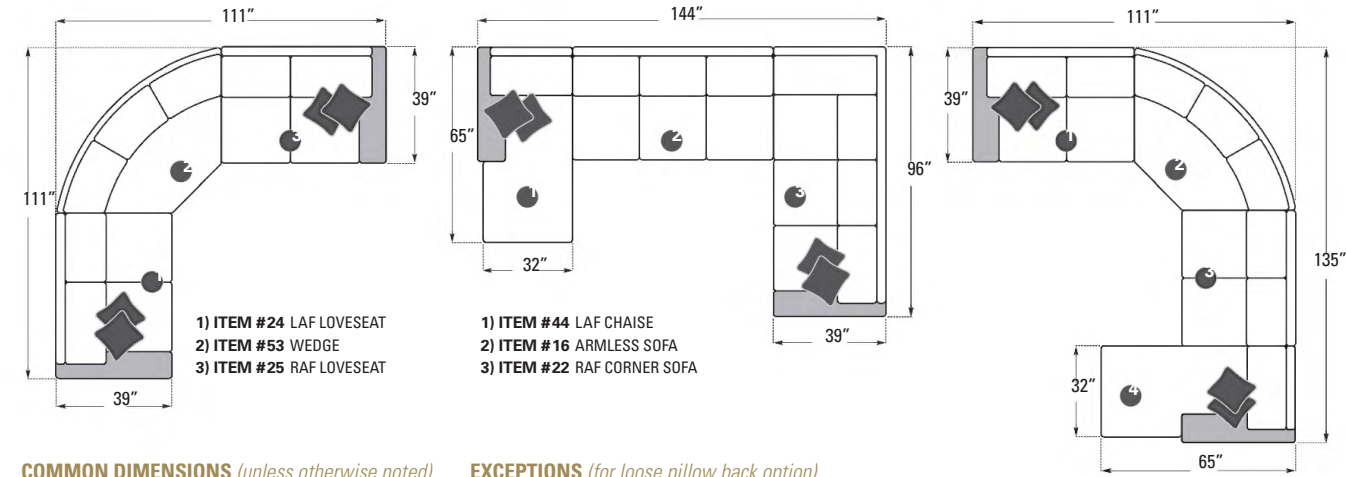

COMMON DIMENSIONS (unless otherwise noted)

OVERALL HEIGHT (exceptions below) 36"
 OVERALL DEPTH (exceptions below) 39"
 SEAT HEIGHT 19"
 SEAT DEPTH (exceptions on back) 23"
 ARM HEIGHT (PANEL/SOCK) 23"
 ARM HEIGHT (TRACK/DECO) 22"

EXCEPTIONS (for loose pillow back option)

L/RAF CORNER SOFA (loose pillow back) OVERALL LENGTH 97"
 CORNER CHAIR (loose pillow back) OVERALL LENGTH 40"
 WEDGE DIAGONAL (loose pillow back) LENGTH 78"

- 1) ITEM #24 LAF LOVESEAT
- 2) ITEM #53 WEDGE
- 3) ITEM #25 RAF LOVESEAT
- 1) ITEM #44 LAF CHAISE
- 2) ITEM #16 ARMLESS SOFA
- 3) ITEM #22 RAF CORNER SOFA
- 1) ITEM #24 LAF LOVESEAT
- 2) ITEM #53 WEDGE
- 3) ITEM #26 ARMLESS LOVESEAT
- 4) ITEM #45 RAF CHAISE

EXCEPTIONS

TRACK ARM: Subtract 3" PER ARM from overall frame length. Inside length does not change.
DECO ARM: Subtract 2" PER ARM from overall frame length. Inside length does not change.
LOOSE PILLOW BACK: Add 1" to overall depth and overall height for pieces with loose pillow backs. Seat depth does not change.

VELCRO

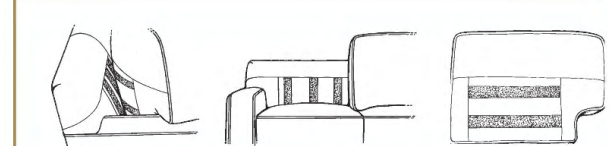

Leather styles feature velcro on the back side of the loose pillow backs. This method keeps the back cushions in place, as leather has a tendency to be slippery, causing them to slide down over the seat cushion.



SMITH BROTHERS of BERNE

DESIGN Your Way

8141 LAF End Wedge, 8101 Armless Sofa, 8141 RAF Corner Sofa

8000 Series

8000 SERIES | AVAILABLE PIECES

DIAGRAMS 1/4"=1'
 PILLOWS ARE NOT STANDARD ON LEATHER.

EXCEPTIONS

NOTE: Sock/Panel Arm with Semi-attached Back (8x11/8x21) example diagrams shown below.
TRACK ARM: Subtract 3" PER ARM from overall frame length. Inside length does not change.
DECO ARM: Subtract 2" PER ARM from overall frame length. Inside length does not change.
LOOSE PILLOW BACK: Add 1" to overall depth and overall height for pieces with loose pillow backs. Seat depth does not change.
 See inside for additional dimensions. All dimensions are approximate and subject to change without notice. See www.smithbrothersfurniture.com for more information.

LAF = Left Arm Facing, RAF = Right Arm Facing

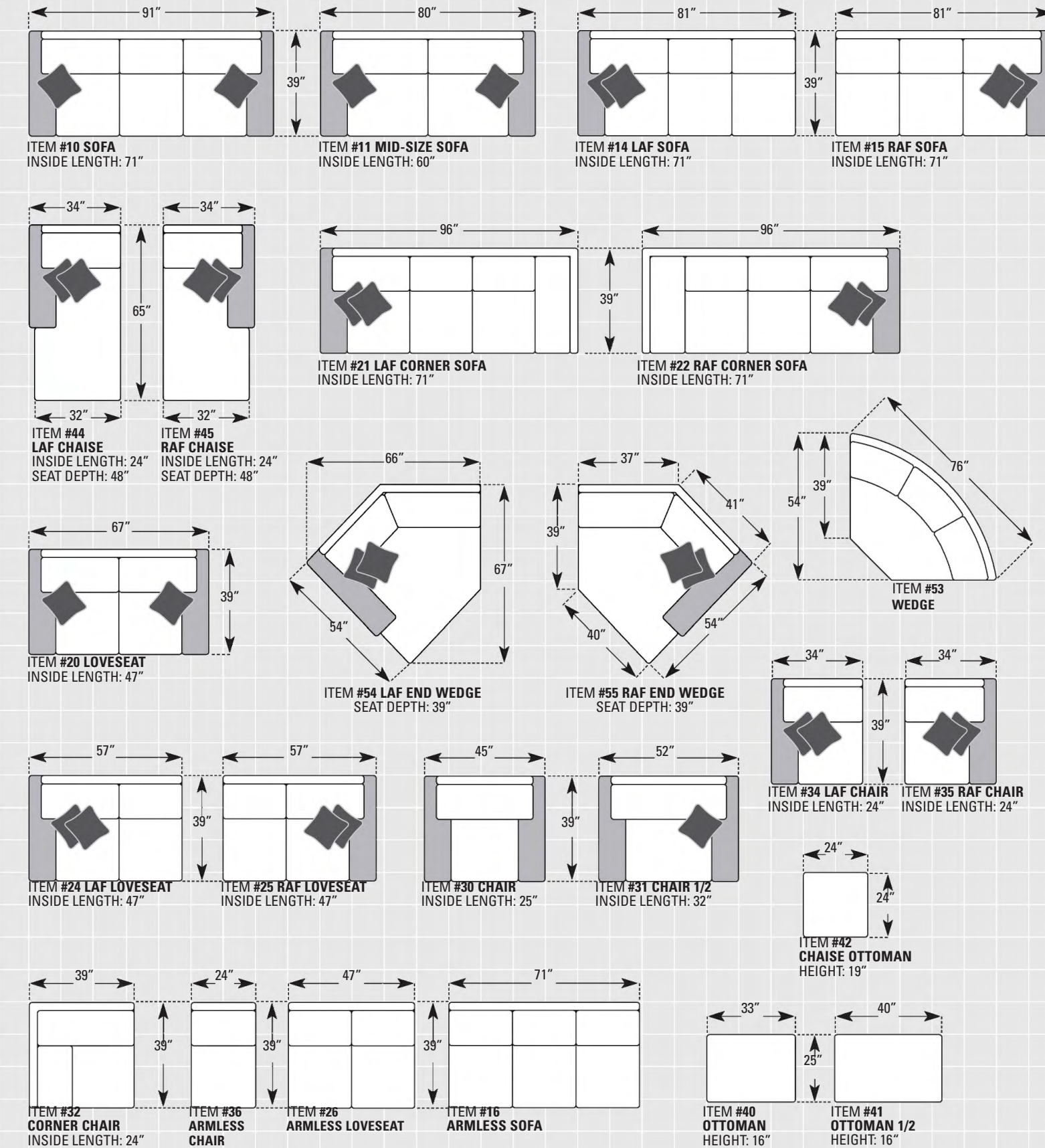



Examples

8100 pieces with welt cord: Style #13, 20" pillows with welt cord
 8200 pieces with top stitched seams: Style #12, 20" pillows without welt cord

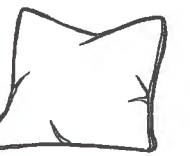

8141-20 Leather Loveseat
 Welts, Deco Arm, Semi-Attached Back
 Leather pieces are not standard with pillows



8121-10 Sofa
 Welts, Panel Arm, Semi-Attached Back
 Standard with one pair style #13, 20" pillows



8231-30 Leather Chair
 Top Stitch, Track Arm, Semi-Attached Back

1 CHOOSE YOUR SEAM

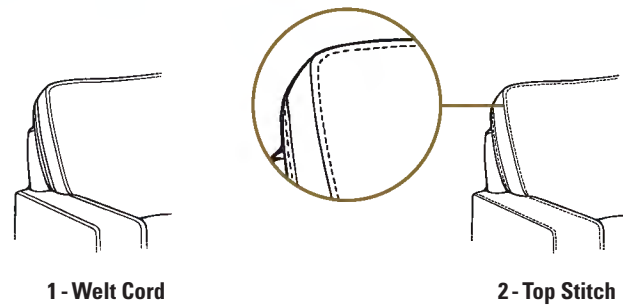

2 CHOOSE YOUR ARM

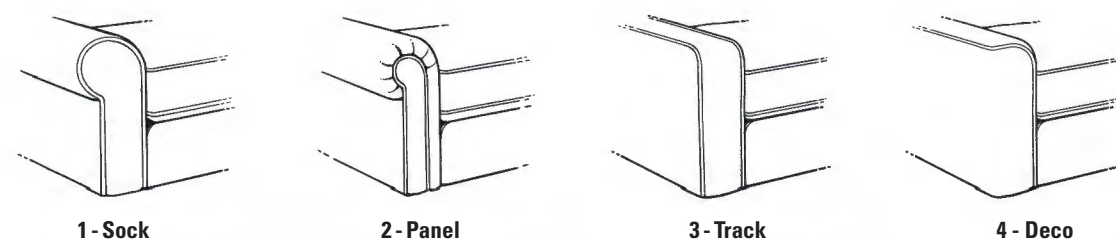

3 CHOOSE YOUR BACK



*Loose Pillow Back options incur an additional charge.



8112-31 Chair 1/2
 Welts, Sock Arm, Loose Pillow Boxing Back
 Standard with one style #13, 20" pillow



8100-41 Ottoman 1/2
 Welts, No Arm, No Back



8131-14 LAF Sofa
 8131-45 RAF Chaise
 Welts, Track Arm, Semi-Attached Back
 Standard with two pair style #13, 20" pillows



8143-21 LAF Corner Sofa
 8103-26 Armless Loveseat
 8143-55 RAF End Wedge
 Welts, Deco Arm, Loose Pillow Knife Edge Back
 Standard with two pair style #13, 20" pillows

WRITE YOUR ORDER **8 1 2 3** - ITEM #
 SEAM ARM BACK

For pieces where a style code does not apply (such as arm styles on armless pieces), enter "0" in that position. For example, an Ottoman SKU (item #40) with top stitching would be written as 8200-40. Only the Seam Style Code and the Item Number are needed because Arms and Backs do not apply in this case.

For more detailed information go to: www.smithbrothersfurniture.com

CHOOSE YOUR COMFORT

The 9000 series is Standard with foam cushion and fiber back. A Feather Down cushion and back upgrade is available for an additional charge.



9141-30



9141-30

Standard
Foam cushion & fiber back
Choose standard for a more tailored look & traditional sit

Feather Down*
Cushion & Back
Choose Feather Down for a relaxed, "wrinkles included" look & sink-in-soft sit
**Feather Down option incurs an additional charge*

SAMPLE CONFIGURATIONS

SAMPLE CONFIGURATION DIMENSIONS REPRESENT PANEL/RAISED PANEL ARM OPTIONS.

EXCEPTIONS: ENGLISH/TRACK/DECO ARMS: Subtract 3" **PER ARM** from overall frame length. Inside length does not change.

Diagrams below are not to scale. All dimensions are approximate and subject to change without notice. Visit smithbrothersfurniture.com for the most recent dimensions.

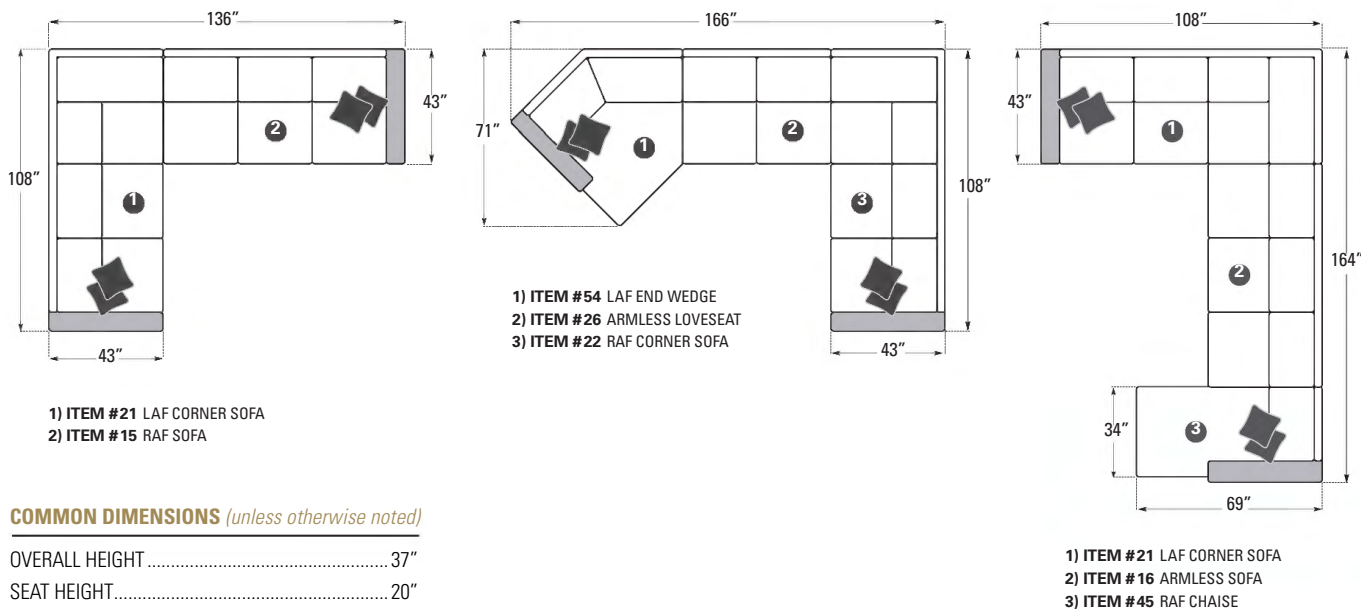

COMMON DIMENSIONS (unless otherwise noted)

- OVERALL HEIGHT37"
- SEAT HEIGHT.....20"
- ARM HEIGHT.....24"
- RAISED PANEL ARM HEIGHT.....25"
- SEAT DEPTH (*exceptions on back*).....23"

VELCRO

Leather styles feature Velcro on the back side of the loose pillow backs. This method keeps the back cushions in place, as leather has a tendency to be slippery, causing them to slide down over the seat cushion.

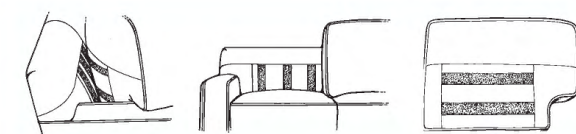

SMITH BROTHERS
of BERNE



DESIGN Your Way

9132-10 Sofa
Shown with feather down option.

9000 Series

9000 SERIES

AVAILABLE PIECES | PILLOWS ARE NOT STANDARD ON LEATHER STYLES

PANEL/RAISED PANEL ARM DIMENSIONS SHOWN

DIMENSION EXCEPTIONS

ENGLISH/TRACK/DECO ARMS: Subtract 3" **per arm** from overall frame length. Inside length does not change.

DIAGRAMS 1/4" = 1'
Dimensions are approximate.

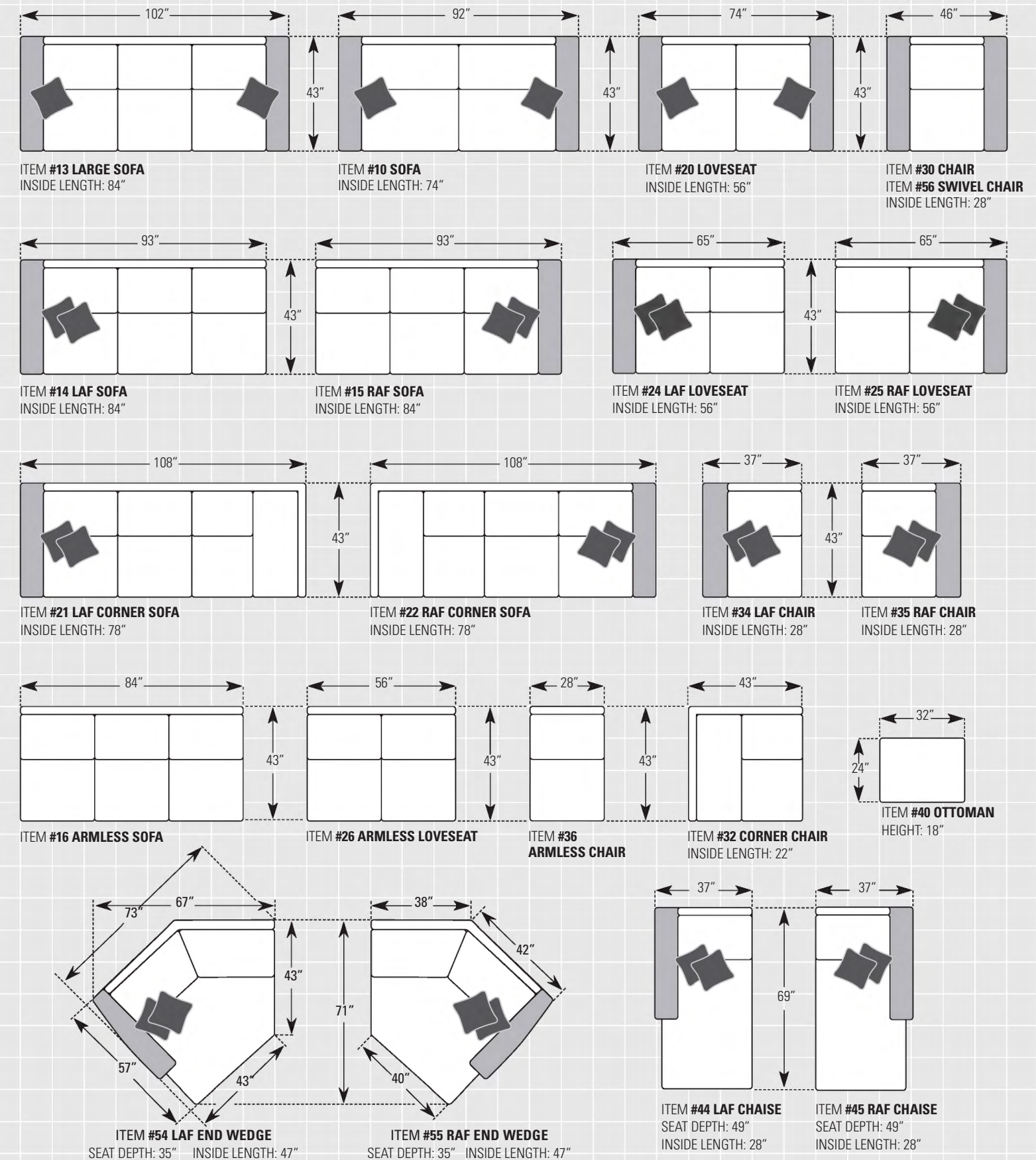



9121

1

CHOOSE YOUR LEG

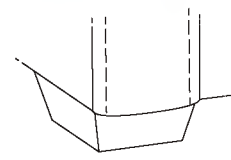

1 - Tapered

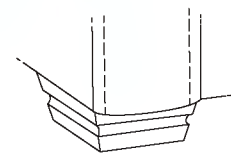

2 - Carved Tapered

2

CHOOSE YOUR ARM

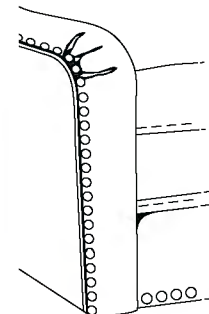

1 - English

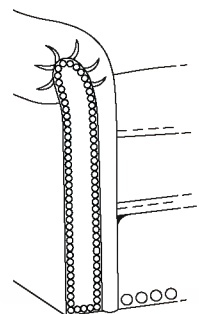

2 - Panel

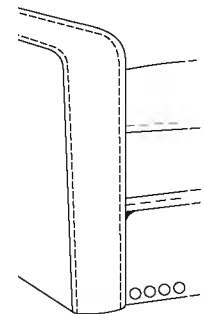

3 - Track

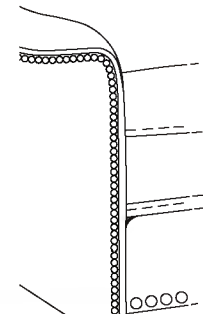

4 - Deco

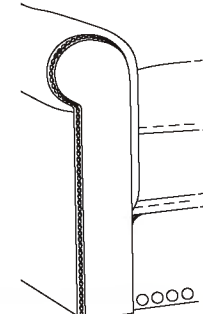

5 - Raised Panel

3

CHOOSE YOUR BACK

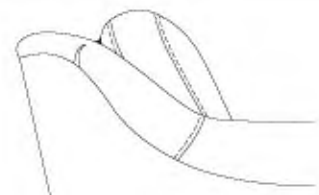

1 - Loose Pillow Boxing



2 - Loose Pillow Knife Edge

*Down option available for an additional charge.

WRITE YOUR ORDER

9 1 2 3 - ITEM #
BASE ARM BACK

For pieces where a style code does not apply (such as arm styles on armless pieces), enter "0" in that position. For example, an Ottoman SKU (item #40) with Tapered Legs would be written as 9100-40. Only the Leg Style Code and the Item Number are needed because Arms and Backs do not apply in this case.

Examples

9000 fabric sectional pieces with an arm: Style #12, 20" pillows without welt cord



9111-13 English Arm
Tapered Leg, Loose Pillow Boxing, Large Sofa (-13)
Shown with standard foam & fiber
Medium size nailhead shown standard
Nailhead cannot be removed from English Arm Option
Standard with one pair style #12, 20" pillows



9121 - Panel Arm



9131 - Track Arm



9141 - Deco Arm



9151 - Raised Panel Arm



9132-10 Sofa
Tapered Leg, Track Arm, Loose Pillow Knife Edge
Shown with feather down upgrade
Medium size nailhead shown standard
Nailhead available on the base only
Standard with one pair style #12, 20" pillows



9242-44 LAF Chaise
9202-16 Armless Sofa
9242-22 RAF Corner Sofa
Carved Tapered Leg, Deco Arm, Loose Pillow Knife Edge
Shown with standard foam & fiber
Small and medium size nailhead shown standard
Standard with two pair style #12, 20" pillows



9111-21 LAF Corner Sofa
9111-25 RAF Loveseat
Tapered Leg, English Arm, Loose Pillow Boxing
Shown with standard foam & fiber
Medium size nailhead shown standard
Nailhead cannot be removed from English Arm Option
Leather pieces are not standard with pillows



9021-56 Swivel Chair
No Leg (Swivel Base), Panel Arm, Loose Pillow Boxing Back
Shown with standard foam & fiber
Small and medium size nailhead shown standard
Chairs are not standard with pillows

9100-40 Ottoman
Tapered Leg, No Arm, No Back
Medium size nailhead shown standard
Ottomans are not standard with pillows



9251-54 LAF End Wedge
9201-16 Armless Sofa
9251-22 RAF Corner Sofa
Carved Tapered Leg, Raised Panel Arm, Loose Pillow Boxing
Shown with feather down upgrade
Small and medium size nailhead shown standard
Standard with two pair style #12, 20" pillows